

# xPC Target

**For Use with Real-Time Workshop<sup>®</sup>**

■ Modeling

■ Simulation

■ Implementation

## How to Contact The MathWorks:



www.mathworks.com	Web
comp.soft-sys.matlab	Newsgroup



support@mathworks.com	Technical support
suggest@mathworks.com	Product enhancement suggestions
bugs@mathworks.com	Bug reports
doc@mathworks.com	Documentation error reports
service@mathworks.com	Order status, license renewals, passcodes
info@mathworks.com	Sales, pricing, and general information



508-647-7000	Phone
--------------	-------



508-647-7001	Fax
--------------	-----



The MathWorks, Inc. 3 Apple Hill Drive Natick, MA 01760-2098	Mail
--	------

For contact information about worldwide offices, see the MathWorks Web site.

### *xPC Target I/O Reference Guide*

© COPYRIGHT 2000 - 2005 by The MathWorks, Inc.

The software described in this document is furnished under a license agreement. The software may be used or copied only under the terms of the license agreement. No part of this manual may be photocopied or reproduced in any form without prior written consent from The MathWorks, Inc.

**FEDERAL ACQUISITION:** This provision applies to all acquisitions of the Program and Documentation by, for, or through the federal government of the United States. By accepting delivery of the Program or Documentation, the government hereby agrees that this software or documentation qualifies as commercial computer software or commercial computer software documentation as such terms are used or defined in FAR 12.212, DFARS Part 227.72, and DFARS 252.227-7014. Accordingly, the terms and conditions of this Agreement and only those rights specified in this Agreement, shall pertain to and govern the use, modification, reproduction, release, performance, display, and disclosure of the Program and Documentation by the federal government (or other entity acquiring for or through the federal government) and shall supersede any conflicting contractual terms or conditions. If this License fails to meet the government's needs or is inconsistent in any respect with federal procurement law, the government agrees to return the Program and Documentation, unused, to The MathWorks, Inc.

MATLAB, Simulink, Stateflow, Handle Graphics, Real-Time Workshop, and xPC TargetBox are registered trademarks of The MathWorks, Inc.

Other product or brand names are trademarks or registered trademarks of their respective holders.

Printing History:	November 2000	Online only	New for Version 1.1 (Release 12.0)
	June 2001	Online only	Revised for Version 1.2 (Release 12.1)
	September 2001	Online only	Revised for Version 1.3 (Release 12.1+)
	July 2002	Online only	Revised for Version 2 (Release 13)
	September 2002	Online only	Revised for Version 2.0.1 (Release 13)
	September 2003	Online only	Revised for Version 2.0.1 (Release 13 SP1)
	June 2004	Online only	Revised for Version 2.5 (Release 14)
	August 2004	Online only	Revised for Version 2.6 (Release 14+)
	October 2004	Online only	Revised for Version 2.6.1 (Release 14SP1)
	November 2004	Online only	Revised for Version 2.7 (Release 14SP1+)
	March 2005	Online only	Revised for Version 2.7.2 (Release 14SP2)



## xPC Target I/O Library

1

<b>I/O Driver Blocks</b> .....	1-2
I/O Driver Block Library .....	1-2
Memory-Mapped Devices .....	1-5
ISA Bus I/O Devices .....	1-5
PCI Bus I/O Devices .....	1-6
xPC Target I/O Driver Structures .....	1-7
PWM and FM Driver Block Notes .....	1-8
Updated Driver Information .....	1-10
<b>Adding I/O Blocks with the xPC Target Library</b> .....	1-11
<b>Adding I/O Blocks with the Simulink Library Browser</b> ..	1-15
<b>Defining I/O Block Parameters</b> .....	1-19

## Serial Communications Support

2

<b>Introduction to Serial Drivers</b> .....	2-2
Hardware Connections for RS-232 .....	2-3
Host and Target PC Communication .....	2-3
<b>xPC Target RS-232 and 422/485 Drivers (Composite)</b> .....	2-5
Adding RS-232 Blocks .....	2-6
Building and Running the Target Application (Composite) ..	2-11
RS-232/422/485 Simulink Block Reference .....	2-12

<b>xPC Target RS-232 Drivers (Conventional)</b> .....	<b>2-60</b>
Simulink Blocks for RS-232 I/O (Conventional) .....	<b>2-60</b>
MATLAB Message Structures for RS-232 I/O (Conventional)	<b>2-61</b>
RS-232 Synchronous Mode (Conventional) .....	<b>2-62</b>
RS-232 Asynchronous Mode (Conventional) .....	<b>2-71</b>
RS-232 Simulink Block Reference (Conventional) .....	<b>2-83</b>
RS-232 MATLAB Structure Reference (Conventional) .....	<b>2-88</b>
RS-232 Binary Mode (Conventional) .....	<b>2-93</b>

## GPIB I/O Support

# 3

<b>Introduction to GPIB Drivers</b> .....	<b>3-2</b>
Hardware Connections for GPIB .....	<b>3-2</b>
Simulink Blocks for GPIB .....	<b>3-3</b>
MATLAB Message Structures for GPIB .....	<b>3-3</b>
<b>Using GPIB Drivers</b> .....	<b>3-5</b>
Adding GPIB Driver Blocks .....	<b>3-5</b>
Creating GPIB Message Structures .....	<b>3-10</b>
<b>GPIB Simulink Block Reference</b> .....	<b>3-13</b>
GPIB-232CT-A Setup Block .....	<b>3-13</b>
GPIB-232CT-A Send/Receive Block .....	<b>3-15</b>
<b>GPIB MATLAB Structure Reference</b> .....	<b>3-16</b>
GPIB Initialization and Termination Message Structures ...	<b>3-17</b>
GPIB Send/Receive Message Structure .....	<b>3-18</b>
Shortcuts and Features for Messages .....	<b>3-21</b>
Supported Data Types for Message Fields .....	<b>3-23</b>

<b>Introduction</b> .....	4-3
xPC Target CAN Library .....	4-3
CAN-AC2 .....	4-5
CAN-AC2-PCI .....	4-6
CAN-AC2-104 .....	4-6
<b>CAN Driver Blocks for the CAN-AC2 (ISA) with Philips</b>	
<b>PCA 82C200 CAN Controller</b> .....	4-7
Setup Driver Block .....	4-8
Send Driver Block .....	4-10
Receive Driver Block .....	4-11
<b>CAN Driver Blocks for the CAN-AC2 (ISA) with Intel 82527</b>	
<b>CAN Controller</b> .....	4-14
Setup Driver Block .....	4-15
Send Driver Block .....	4-18
Receive Driver Block .....	4-20
<b>CAN Driver Blocks for the CAN-AC2-PCI with Philips</b>	
<b>SJA1000 CAN Controller</b> .....	4-22
Setup Driver Block .....	4-23
Send Driver Block .....	4-26
Receive Driver Block .....	4-28
<b>CAN Driver Blocks for the CAN-AC2-104 (PC/104) with</b>	
<b>Philips SJA1000 CAN Controller</b> .....	4-30
Setup Driver Block .....	4-31
Send Driver Block .....	4-34
Receive Driver Block .....	4-36
<b>Constructing and Extracting CAN Data Frames</b> .....	4-38
CAN Bit-Packing Block .....	4-39
CAN Bit-Unpacking Block .....	4-43
<b>Detecting Time-Outs When Receiving CAN Messages</b> ....	4-47
CAN Timeout Detection Block .....	4-48

<b>Model Execution Driven by CAN Messages</b>	
<b>(Interrupt Capability of CAN Receive Blocks)</b> .....	<b>4-49</b>
CAN-AC2 (ISA) .....	<b>4-49</b>
CAN-AC2-PCI .....	<b>4-50</b>
CAN-AC2-104 (PC/104) .....	<b>4-51</b>
<b>Defining Initialization and Termination CAN Messages</b> ..	<b>4-53</b>
Example .....	<b>4-54</b>
<b>CAN-AC2 and CANopen Devices</b> .....	<b>4-55</b>

## CAN I/O Support for FIFO

# 5

<b>Introduction</b> .....	<b>5-2</b>
FIFO Mode Drivers for CAN Boards from Softing .....	<b>5-3</b>
<b>CAN FIFO Driver Blocks for the CAN-AC2-PCI with</b>	
<b>Philips SJA1000 CAN Controller</b> .....	<b>5-6</b>
FIFO Setup Driver Block .....	<b>5-7</b>
FIFO Write Driver Block .....	<b>5-11</b>
FIFO Read Driver Block .....	<b>5-13</b>
FIFO Read Filter Block .....	<b>5-16</b>
FIFO Read XMT Level Driver Block .....	<b>5-18</b>
FIFO Reset XMT Driver Block .....	<b>5-19</b>
FIFO Read RCV Level Driver Block .....	<b>5-20</b>
FIFO Reset RCV Driver Block .....	<b>5-21</b>



<b>CAN FIFO Driver Blocks for the CAN-AC2-104 with Philips SJA1000 CAN Controller</b> .....	<b>5-22</b>
FIFO Setup Driver Block .....	<b>5-23</b>
FIFO Write Driver Block .....	<b>5-27</b>
FIFO Read Driver Block .....	<b>5-29</b>
FIFO Read Filter Block .....	<b>5-32</b>
FIFO Read XMT Level Driver Block .....	<b>5-34</b>
FIFO Reset XMT Driver Block .....	<b>5-35</b>
FIFO Read RCV Level Driver Block .....	<b>5-36</b>
FIFO Reset RCV Driver Block .....	<b>5-36</b>
 <b>Acceptance Filters</b> .....	 <b>5-38</b>
 <b>Examples</b> .....	 <b>5-40</b>
Example 1 .....	<b>5-40</b>
Example 2 .....	<b>5-42</b>
Example 3 .....	<b>5-43</b>
Example 4 .....	<b>5-44</b>
Example 5 .....	<b>5-44</b>
Example 6 .....	<b>5-45</b>

## UDP I/O Support

# 6

<b>User Datagram Protocol (UDP)</b> .....	<b>6-2</b>
What Is UDP? .....	<b>6-2</b>
Why UDP? .....	<b>6-4</b>
Note on UDP Communication .....	<b>6-4</b>
 <b>xPC Target UDP Blocks</b> .....	 <b>6-5</b>
UDP Communication Setup .....	<b>6-5</b>
UDP Receive Block .....	<b>6-6</b>
UDP Send Block .....	<b>6-8</b>
UDP Pack Block .....	<b>6-9</b>
UDP Unpack Block .....	<b>6-10</b>
Byte Reversal/Change Endianess Block .....	<b>6-11</b>

<b>xPC Target UDP Examples</b> .....	<b>6-13</b>
UDP Example .....	<b>6-13</b>

## Aerospace I/O Support

# 7

<b>Condor</b> .....	<b>7-2</b>
Board Characteristics .....	<b>7-3</b>
Condor CEI-x20 Initialize .....	<b>7-3</b>
Condor CEI-x20 Send .....	<b>7-4</b>
Condor CEI-x20 Receive .....	<b>7-5</b>
Encode ARINC 429 Words for Send .....	<b>7-6</b>
Decode ARINC 429 Words from Receive .....	<b>7-9</b>

## Access IO

# 8

<b>WDG-CSM</b> .....	<b>8-2</b>
WDG-CSM Watchdog Timer .....	<b>8-2</b>

## ADDI-DATA

# 9

<b>APCI-1710</b> .....	<b>9-2</b>
APCI-1710 Incremental Encoder .....	<b>9-2</b>
<b>PA-1700</b> .....	<b>9-5</b>
PA-1700 Incremental Encoder .....	<b>9-5</b>

**10**

<b>Adlink PCI-8133</b> .....	<b>10-2</b>
PCI-8133 3-Phase PWM .....	<b>10-2</b>
<b>Adlink PCI-6208A</b> .....	<b>10-5</b>
PCI-6208A Analog Output .....	<b>10-5</b>
PCI-6208A Digital Input .....	<b>10-7</b>
PCI-6208A Digital Output .....	<b>10-8</b>

**11**

<b>PCL-1800</b> .....	<b>11-3</b>
PCL-1800 Analog Input (A/D) .....	<b>11-3</b>
PCL-1800 Analog Output (D/A) .....	<b>11-5</b>
PCL-1800 Digital Input .....	<b>11-6</b>
PCL-1800 Digital Output .....	<b>11-7</b>
<b>PCL-711B</b> .....	<b>11-8</b>
PCL-711B Analog Input (A/D) .....	<b>11-8</b>
PCL-711B Analog Output (D/A) .....	<b>11-10</b>
PCL-711B Digital Input .....	<b>11-10</b>
PCL-711B Digital Output .....	<b>11-11</b>
<b>PCL-726</b> .....	<b>11-12</b>
PCL-726 Analog Output (D/A) .....	<b>11-12</b>
PCL-726 Digital Input .....	<b>11-14</b>
PCL-726 Digital Output .....	<b>11-15</b>
<b>PCL-727</b> .....	<b>11-16</b>
PCL-727 Analog Output (D/A) .....	<b>11-16</b>
PCL-727 Digital Input .....	<b>11-18</b>
PCL-727 Digital Output .....	<b>11-19</b>

<b>PCL-728</b> .....	<b>11-20</b>
PCL-728 Analog Output (D/A) .....	11-20
<b>PCL-812</b> .....	<b>11-22</b>
PCL-812 Analog Input (A/D) .....	11-22
PCL-812 Analog Output (D/A) .....	11-24
PCL-812 Digital Input .....	11-25
PCL-812 Digital Output .....	11-26
<b>PCL-812PG</b> .....	<b>11-27</b>
PCL-812PG Analog Input (A/D) .....	11-27
PCL-812PG Analog Output (D/A) .....	11-29
PCL-812PG Digital Input .....	11-30
PCL-812PG Digital Output .....	11-31
<b>PCL-818</b> .....	<b>11-32</b>
PCL-818 Analog Input (A/D) .....	11-32
PCL-818 Analog Output (D/A) .....	11-34
PCL-818 Digital Input .....	11-35
PCL-818 Digital Output .....	11-36
<b>PCL-818H</b> .....	<b>11-38</b>
PCL-818H Analog Input (A/D) .....	11-38
PCL-818H Analog Output (D/A) .....	11-40
PCL-818H Digital Input .....	11-41
PCL-818H Digital Output .....	11-42
<b>PCL-818HD</b> .....	<b>11-43</b>
PCL-818HD Analog Input (A/D) .....	11-43
PCL-818HD Analog Output (D/A) .....	11-45
PCL-818HD Digital Input .....	11-46
PCL-818HD Digital Output .....	11-47
<b>PCL-818HG</b> .....	<b>11-48</b>
PCL-818HG Analog Input (A/D) .....	11-48
PCL-818HG Analog Output (D/A) .....	11-50
PCL-818HG Digital Input .....	11-51
PCL-818HG Digital Output .....	11-52

<b>PCL-818L</b> .....	<b>11-53</b>
PCL-818L Analog Input (A/D) .....	<b>11-53</b>
PCL-818L Analog Output (D/A) .....	<b>11-55</b>
PCL-818L Digital Input .....	<b>11-56</b>
PCL-818L Digital Output .....	<b>11-57</b>

## Analogic

# 12

<b>AIM12</b> .....	<b>12-2</b>
AIM12 Analog Input (A/D) .....	<b>12-3</b>
AIM12 Digital Input .....	<b>12-4</b>
AIM12 Digital Output .....	<b>12-5</b>
<b>AIM16</b> .....	<b>12-6</b>
AIM16 Analog Input (A/D) .....	<b>12-7</b>
AIM16 Digital Input .....	<b>12-8</b>
AIM16 Digital Output .....	<b>12-9</b>

## BittWare

# 13

<b>Audio-PMC+</b> .....	<b>13-2</b>
Audio-PMC+ Analog Input .....	<b>13-3</b>
Audio-PMC+ Analog Output .....	<b>13-5</b>

## BVM

# 14

<b>PMCDIO64</b> .....	<b>14-2</b>
PMCDIO64 Digital Input .....	<b>14-3</b>
PMCDIO64 Digital Output .....	<b>14-4</b>

<b>Contec AD12-16(PCI)</b> .....	<b>15-3</b>
AD12-16(PCI) Analog Input (A/D) .....	<b>15-3</b>
AD12-16(PCI) Digital Input .....	<b>15-5</b>
AD12-16(PCI) Digital Output .....	<b>15-6</b>
<b>Contec AD12-16(PCI)E</b> .....	<b>15-8</b>
AD12-16(PCI)E Analog Input (A/D) .....	<b>15-8</b>
AD12-16(PCI)E Analog Output (D/A) .....	<b>15-10</b>
<b>Contec AD12-16U(PCI)E</b> .....	<b>15-11</b>
AD12-16U(PCI)E Analog Input (A/D) .....	<b>15-11</b>
AD12-16U(PCI)E Analog Output (D/A) .....	<b>15-12</b>
<b>Contec ADI12-16(PCI)</b> .....	<b>15-14</b>
ADI12-16(PCI) Analog Input (A/D) .....	<b>15-14</b>
<b>Contec AD12-64(PCI)</b> .....	<b>15-16</b>
AD12-64(PCI) Analog Input (A/D) .....	<b>15-16</b>
AD12-64(PCI) Digital Input .....	<b>15-18</b>
AD12-64(PCI) Digital Output .....	<b>15-19</b>
<b>Contec AD16-16(PCI)E</b> .....	<b>15-21</b>
AD16-16(PCI)E Analog Input (A/D) .....	<b>15-21</b>
AD16-16(PCI)E Analog Output (D/A) .....	<b>15-22</b>
<b>Contec DA12-4(PCI)</b> .....	<b>15-24</b>
DA12-4(PCI) Analog Output (D/A) .....	<b>15-24</b>
<b>Contec DA12-16(PCI)</b> .....	<b>15-26</b>
DA12-16(PCI) Analog Output (D/A) .....	<b>15-26</b>
<b>Contec PIO-32/32T(PCI)</b> .....	<b>15-28</b>
PIO-32/32T(PCI) Digital Input .....	<b>15-28</b>
PIO-32/32T(PCI) Digital Output .....	<b>15-29</b>
<b>Contec CNT24-4D(PCI)</b> .....	<b>15-31</b>
CNT24-4D(PCI) Incremental Encoder .....	<b>15-31</b>

<b>DT2821</b> .....	<b>16-3</b>
DT2821 Analog Input (A/D) .....	<b>16-3</b>
DT2821 Analog Output (D/A) .....	<b>16-5</b>
DT2821 Digital Input .....	<b>16-6</b>
DT2821 Digital Output .....	<b>16-7</b>
<b>DT2821-F-8DI</b> .....	<b>16-8</b>
DT2821-F-8DI Analog Input (A/D) .....	<b>16-8</b>
DT2821-F-8DI Analog Output (D/A) .....	<b>16-10</b>
DT2821-F-8DI Digital Input .....	<b>16-11</b>
DT2821-F-8DI Digital Output .....	<b>16-12</b>
<b>DT2821-G-8DI</b> .....	<b>16-13</b>
DT2821-G-8DI Analog Input (A/D) .....	<b>16-13</b>
DT2821-G-8DI Analog Output (D/A) .....	<b>16-15</b>
DT2821-G-8DI Digital Input .....	<b>16-16</b>
DT2821-G-8DI Digital Output .....	<b>16-17</b>
<b>DT2821-F-16SE</b> .....	<b>16-18</b>
DT2821-F-16SE Analog Input (A/D) .....	<b>16-18</b>
DT2821-F-16SE Analog Output (D/A) .....	<b>16-20</b>
DT2821-F-16SE Digital Input .....	<b>16-21</b>
DT2821-F-16SE Digital Output .....	<b>16-22</b>
<b>DT2821-G-16SE</b> .....	<b>16-23</b>
DT2821-G-16SE Analog Input (A/D) .....	<b>16-23</b>
DT2821-G-16SE Analog Output (D/A) .....	<b>16-25</b>
DT2821-G-16SE Digital Input .....	<b>16-26</b>
DT2821-G-16SE Digital Output .....	<b>16-27</b>
<b>DT2823</b> .....	<b>16-28</b>
DT2823 Analog Input (A/D) .....	<b>16-28</b>
DT2823 Analog Output (D/A) .....	<b>16-29</b>
DT2823 Digital Input .....	<b>16-30</b>
DT2823 Digital Output .....	<b>16-31</b>

<b>DT2824-PGH</b> .....	<b>16-33</b>
DT2824-PGH Analog Input (A/D) .....	<b>16-33</b>
DT2824-PGH Digital Input .....	<b>16-35</b>
DT2824-PGH Digital Output .....	<b>16-36</b>
<b>DT2824-PGL</b> .....	<b>16-37</b>
DT2824-PGL Analog Input (A/D) .....	<b>16-37</b>
DT2824-PGL Digital Input .....	<b>16-39</b>
DT2824-PGL Digital Output .....	<b>16-40</b>
<b>DT2825</b> .....	<b>16-41</b>
DT2825 Analog Input (A/D) .....	<b>16-41</b>
DT2825 Analog Output (D/A) .....	<b>16-43</b>
DT2825 Digital Input .....	<b>16-44</b>
DT2825 Digital Output .....	<b>16-45</b>
<b>DT2827</b> .....	<b>16-46</b>
DT2827 Analog Input (A/D) .....	<b>16-46</b>
DT2827 Analog Output (D/A) .....	<b>16-47</b>
DT2827 Digital Input .....	<b>16-48</b>
DT2827 Digital Output .....	<b>16-49</b>
<b>DT2828</b> .....	<b>16-51</b>
DT2828 Analog Input (A/D) .....	<b>16-51</b>
DT2828 Analog Output (D/A) .....	<b>16-53</b>
DT2828 Digital Input .....	<b>16-54</b>
DT2828 Digital Output .....	<b>16-55</b>

## Diamond

# 17

<b>Diamond-MM</b> .....	<b>17-3</b>
MM Analog Input (A/D) .....	<b>17-3</b>
MM Analog Output (D/A) .....	<b>17-5</b>
MM Digital Input .....	<b>17-7</b>
MM Digital Output .....	<b>17-7</b>



<b>Diamond-MM-16-AT</b> .....	<b>17-9</b>
MM-16-AT Analog Input (A/D) .....	<b>17-10</b>
MM-16-AT Analog Output (D/A) .....	<b>17-11</b>
MM-16-AT Digital Input .....	<b>17-12</b>
MM-16-AT Digital Output .....	<b>17-13</b>
<b>Diamond-MM-32-AT</b> .....	<b>17-15</b>
MM-32-AT Analog Input (A/D) .....	<b>17-16</b>
MM-32-AT Frame Analog Input (A/D) .....	<b>17-17</b>
MM-32-AT Analog Output (D/A) .....	<b>17-20</b>
MM-32-AT Digital Input .....	<b>17-21</b>
MM-32-AT Digital Output .....	<b>17-22</b>
<b>Garnet-MM</b> .....	<b>17-25</b>
Garnet-MM Digital Input .....	<b>17-25</b>
Garnet-MM Digital Output .....	<b>17-26</b>
<b>Onyx-MM</b> .....	<b>17-28</b>
Onyx-MM Digital Input .....	<b>17-28</b>
Onyx-MM Digital Output .....	<b>17-29</b>
<b>Onyx-MM-DIO</b> .....	<b>17-31</b>
Onyx-MM-DIO Digital Input .....	<b>17-31</b>
Onyx-MM-DIO Digital Output .....	<b>17-32</b>
<b>Prometheus</b> .....	<b>17-34</b>
Prometheus Analog Input (A/D) .....	<b>17-35</b>
Prometheus Analog Output (D/A) .....	<b>17-36</b>
Prometheus Digital Input .....	<b>17-37</b>
Prometheus Digital Output .....	<b>17-38</b>

<b>Quartz-MM 5</b> .....	<b>17-40</b>
Quartz-MM 5 Digital Input .....	<b>17-41</b>
Quartz-MM 5 Digital Output .....	<b>17-42</b>
Quartz-MM5 Counter PWM .....	<b>17-43</b>
Quartz-MM5 Counter PWM & ARM .....	<b>17-44</b>
Quartz-MM5 Counter FM .....	<b>17-46</b>
Quartz-MM5 Counter FM & ARM .....	<b>17-47</b>
Quartz-MM5 PWM Capture .....	<b>17-49</b>
Quartz-MM5 FM Capture .....	<b>17-50</b>
Quartz-MMxx .....	<b>17-51</b>
<b>Quartz-MM 10</b> .....	<b>17-52</b>
Quartz-MM 10 Digital Input .....	<b>17-53</b>
Quartz-MM 10 Digital Output .....	<b>17-54</b>
Quartz-MM 10 Counter PWM .....	<b>17-54</b>
Quartz-MM 10 Counter PWM & ARM .....	<b>17-56</b>
Quartz-MM 10 Counter FM .....	<b>17-57</b>
Quartz-MM 10 Counter FM & ARM .....	<b>17-59</b>
Quartz-MM 10 PWM Capture .....	<b>17-60</b>
Quartz-MM 10 FM Capture .....	<b>17-61</b>
Quartz-MMxx .....	<b>17-62</b>
<b>Ruby-MM</b> .....	<b>17-63</b>
Diamond Ruby-MM Analog Output (D/A) .....	<b>17-63</b>
Diamond Ruby-MM Digital Input .....	<b>17-65</b>
Diamond Ruby-MM Digital Output .....	<b>17-66</b>
<b>Ruby-MM-416</b> .....	<b>17-68</b>
Ruby-MM-416 Analog Output (D/A) .....	<b>17-68</b>
Ruby-MM-416 Digital Input .....	<b>17-70</b>
Ruby-MM-416 Digital Output .....	<b>17-71</b>
<b>Ruby-MM-1612</b> .....	<b>17-73</b>
Ruby-MM-1612 Analog Output (D/A) .....	<b>17-73</b>
Ruby-MM-1612 Digital Input .....	<b>17-76</b>
Ruby-MM-1612 Digital Output .....	<b>17-77</b>

**Overview of PMC-ADADIO Functionality** ..... 18-2

- A/D Blocks ..... 18-3
- Create Enable Signal Blocks ..... 18-5
- D/A Blocks ..... 18-8
- Interleaving Analog Input and Analog Output Blocks ..... 18-10
- Using Multiple Boards for Simultaneous Analog to Digital Conversion ..... 18-12

**PMC-ADADIO** ..... 18-14

- PMC-ADADIO Analog Input (A/D) Start ..... 18-15
- PMC-ADADIO Analog Input (A/D) Read ..... 18-16
- PMC-ADADIO Analog Output (D/A) Write ..... 18-17
- PMC-ADADIO Analog Output (D/A) Update ..... 18-20
- PMC-ADADIO Digital Input ..... 18-21
- PMC-ADADIO Digital Output ..... 18-22
- Create Enable Signal ..... 18-24

**PMC-16AO-12** ..... 18-25

- PMC-16AO-12 Analog Output ..... 18-25

**AD 512** ..... 19-2

- AD 512 Analog Input (A/D) ..... 19-3
- AD 512 Analog Output (D/A) ..... 19-4
- AD 512 Digital Input ..... 19-5
- AD 512 Digital Output ..... 19-6

<b>DAS-1800HR</b> .....	<b>20-2</b>
DAS-1800HR Analog Input (A/D) .....	<b>20-3</b>
DAS-1800HR Digital Input .....	<b>20-5</b>
DAS-1800HR Digital Output .....	<b>20-5</b>
<b>KPCI-1801HC</b> .....	<b>20-7</b>
KPCI-1801HC Analog Input (A/D) .....	<b>20-8</b>
KPCI-1801HC Analog Output (D/A) .....	<b>20-10</b>
KPCI-1801HC Digital Input .....	<b>20-11</b>
KPCI-1801HC Digital Output .....	<b>20-12</b>
<b>KPCI-1802HC</b> .....	<b>20-14</b>
KPCI-1802HC Analog Input (A/D) .....	<b>20-15</b>
KPCI-1802HC Analog Output (D/A) .....	<b>20-17</b>
KPCI-1802HC Digital Input .....	<b>20-18</b>
KPCI-1802HC Digital Output .....	<b>20-19</b>

## Measurement Computing (Formerly ComputerBoards)

<b>CIO-CTR05</b> .....	<b>21-5</b>
CIO-CTR05 Counter PWM .....	<b>21-6</b>
CIO-CTR05 Counter PWM & ARM .....	<b>21-7</b>
CIO-CTR05 Counter FM .....	<b>21-9</b>
CIO-CTR05 Counter FM & ARM .....	<b>21-10</b>
CIO-CTR05 PWM Capture .....	<b>21-12</b>
CIO-CTR05 Frequency Capture .....	<b>21-13</b>
CIO-CTRxx .....	<b>21-13</b>

<b>CIO-CTR10</b> .....	<b>21-14</b>
CIO-CTR10 Counter PWM .....	<b>21-15</b>
CIO-CTR10 Counter PWM & ARM .....	<b>21-16</b>
CIO-CTR10 Counter FM .....	<b>21-18</b>
CIO-CTR10 Counter FM & ARM .....	<b>21-19</b>
CIO-CTR10 PWM Capture .....	<b>21-21</b>
CIO-CTR10 Frequency Capture .....	<b>21-22</b>
CIO-CTRxx .....	<b>21-22</b>
<b>CIO-DAC08 (/12)</b> .....	<b>21-23</b>
CIO-DAC08 Analog Output (D/A) .....	<b>21-23</b>
<b>CIO-DAC08/16</b> .....	<b>21-25</b>
CIO-DAC08/16 Analog Output (D/A) .....	<b>21-25</b>
<b>CIO-DAC16 (/12)</b> .....	<b>21-27</b>
CIO-DAC16 Analog Output (D/A) .....	<b>21-27</b>
<b>CIO-DAC16/16</b> .....	<b>21-30</b>
CIO-DAC16/16 Analog Output (D/A) .....	<b>21-30</b>
<b>CIO-DAS16/330</b> .....	<b>21-33</b>
CIO-DAS16/330 Analog Input (A/D) .....	<b>21-34</b>
<b>CIO-DAS16/JR (/12)</b> .....	<b>21-35</b>
CIO-DAS16/JR Analog Input (A/D) .....	<b>21-36</b>
CIO-DAS16/JR (/12) Analog Input (A/D) with EXP Signal Conditioning Board .....	<b>21-37</b>
<b>CIO-DAS16JR/16</b> .....	<b>21-40</b>
CIO-DAS16JR/16 Analog Input (A/D) .....	<b>21-41</b>
<b>CIO-DAS1601/12</b> .....	<b>21-42</b>
CIO-DAS1601/12 Analog Input (A/D) .....	<b>21-43</b>
CIO-DAS1601/12 Analog Output (D/A) .....	<b>21-44</b>
CIO-DAS1601/12 Digital Input .....	<b>21-45</b>
CIO-DAS1601/12 Digital Output .....	<b>21-46</b>

<b>CIO-DAS1602/12</b> .....	<b>21-49</b>
CIO-DAS1602/12 Analog Input (A/D) .....	<b>21-50</b>
CIO-DAS1602/12 Analog Output (D/A) .....	<b>21-51</b>
CIO-DAS1602/12 Digital Input .....	<b>21-52</b>
CIO-DAS1602/12 Digital Output .....	<b>21-53</b>
<b>CIO-DAS1602/16</b> .....	<b>21-55</b>
CIO-DAS1602/16 Analog Input (A/D) .....	<b>21-56</b>
CIO-DAS1602/16 Analog Output (D/A) .....	<b>21-57</b>
CIO-DAS 1602/16 Digital Input .....	<b>21-58</b>
CIO DAS1602/16 Digital Output .....	<b>21-59</b>
<b>CIO-DDA06 (/12)</b> .....	<b>21-61</b>
CIO-DDA06 (/12) Analog Output (D/A) .....	<b>21-62</b>
CIO-DDA06 (/12) Digital Input .....	<b>21-63</b>
CIO-DDA06 (/12) Digital Output .....	<b>21-64</b>
<b>CIO-DDA06/16</b> .....	<b>21-67</b>
CIO-DDA06/16 Analog Output (D/A) .....	<b>21-68</b>
CIO-DDA06/16 Digital Input .....	<b>21-69</b>
CIO-DDA06/16 Digital Output .....	<b>21-70</b>
<b>CIO-DIO24</b> .....	<b>21-73</b>
CIO-DIO24 Digital Input .....	<b>21-73</b>
CIO-DIO24 Digital Output .....	<b>21-74</b>
CIO-DIO24 Signal Conditioning .....	<b>21-76</b>
<b>CIO-DIO24H</b> .....	<b>21-77</b>
CIO-DIO24H Digital Input .....	<b>21-77</b>
CIO-DIO24H Digital Output .....	<b>21-78</b>
<b>CIO-DIO48</b> .....	<b>21-80</b>
CIO-DIO48 Digital Input .....	<b>21-80</b>
CIO-DIO48 Digital Output .....	<b>21-81</b>
<b>CIO-DIO48H</b> .....	<b>21-84</b>
CIO-DIO48H Digital Input .....	<b>21-84</b>
CIO-DIO48H Digital Output .....	<b>21-86</b>

<b>CIO-DIO96</b> .....	<b>21-88</b>
CIO-DIO96 Digital Input .....	<b>21-88</b>
CIO-DIO96 Digital Output .....	<b>21-89</b>
<b>CIO-DIO192</b> .....	<b>21-92</b>
CIO-DIO192 Digital Input .....	<b>21-92</b>
CIO-DIO192 Digital Output .....	<b>21-93</b>
<b>CIO-DO24DD</b> .....	<b>21-96</b>
CIO-DO24DD Digital Output .....	<b>21-96</b>
<b>CIO-PDISO16</b> .....	<b>21-98</b>
CIO-PDISO16 Digital Input .....	<b>21-98</b>
CIO-PDISO16 Digital Output .....	<b>21-99</b>
<b>CIO-QUAD02</b> .....	<b>21-101</b>
CIO-QUAD02 Incremental Encoder .....	<b>21-101</b>
CIO-QUAD02 Incremental Encoder (Obsolete) .....	<b>21-106</b>
<b>CIO-QUAD04</b> .....	<b>21-109</b>
CIO-QUAD04 Incremental Encoder .....	<b>21-110</b>
CIO-QUAD04 Incremental Encoder (Obsolete) .....	<b>21-114</b>
<b>PC104-DAC06 (/12)</b> .....	<b>21-117</b>
PC104-DAC06 (/12) Analog Output (D/A) .....	<b>21-117</b>
<b>PC104-DAS16JR/12</b> .....	<b>21-119</b>
PC104-DAS16JR/12 Analog Input (A/D) .....	<b>21-119</b>
PC104-DAS16JR/12 Digital Input .....	<b>21-121</b>
PC104-DAS16JR/12 Digital Output .....	<b>21-122</b>
<b>PC104-DAS16JR/16</b> .....	<b>21-123</b>
PC104-DAS16JR/16 Analog Input (A/D) .....	<b>21-123</b>
PC104-DAS16JR/16 Digital Input .....	<b>21-125</b>
PC104-DAS16JR/16 Digital Output .....	<b>21-126</b>
<b>PC104-DIO48</b> .....	<b>21-127</b>
PC104-DIO48 Digital Input .....	<b>21-128</b>
PC104-DIO48 Digital Output .....	<b>21-129</b>

<b>PCI-CTR05</b> .....	<b>21-131</b>
PCI-CTR05 Counter PWM .....	<b>21-132</b>
PCI-CTR05 Counter PWM & ARM .....	<b>21-133</b>
PCI-CTR05 Counter FM .....	<b>21-135</b>
PCI-CTR05 Counter FM & ARM .....	<b>21-137</b>
PCI-CTR05 PWM Capture .....	<b>21-138</b>
PCI-CTR05 Frequency Capture .....	<b>21-139</b>
PCI-CTRxx .....	<b>21-140</b>
<b>PCI-DAS1200</b> .....	<b>21-141</b>
PCI-DAS1200 Analog Input (A/D) .....	<b>21-141</b>
PCI-DAS1200 Analog Output (D/A) .....	<b>21-143</b>
PCI-DAS1200 Digital Input .....	<b>21-144</b>
PCI-DAS1200 Digital Output .....	<b>21-146</b>
<b>PCI-DAS1200/JR</b> .....	<b>21-148</b>
PCI-DAS1200/JR Analog Input (A/D) .....	<b>21-148</b>
PCI-DAS1200/JR Digital Input .....	<b>21-149</b>
PCI-DAS1200/JR Digital Output .....	<b>21-151</b>
<b>PCI-DAS1602/12</b> .....	<b>21-153</b>
PCI-DAS1602/12 Analog Input (A/D) .....	<b>21-153</b>
PCI-DAS1602/12 Analog Output (D/A) .....	<b>21-155</b>
PCI-DAS 1602/12 Digital Input .....	<b>21-156</b>
PCI-DAS1602/12 Digital Output .....	<b>21-158</b>
<b>PCI-DAS1602/16</b> .....	<b>21-160</b>
PCI-DAS1602/16 Analog Input (A/D) .....	<b>21-161</b>
PCI-DAS1602/16 Analog Output (D/A) .....	<b>21-162</b>
PCI-DAS 1602/16 Digital Input .....	<b>21-163</b>
PCI-DAS1602/16 Digital Output .....	<b>21-165</b>
<b>PCI-DDA02/12</b> .....	<b>21-167</b>
PCI-DDA02/12 Analog Output (D/A) .....	<b>21-167</b>
PCI-DDA02/12 Digital Input .....	<b>21-169</b>
PCI-DDA02/12 Digital Output .....	<b>21-170</b>



<b>PCI-DDA02/16</b> .....	<b>21-173</b>
PCI-DDA02/16 Analog Output (D/A) .....	<b>21-173</b>
PCI-DDA02/16 Digital Input .....	<b>21-175</b>
PCI-DDA02/16 Digital Output .....	<b>21-176</b>
<b>PCI-DDA04/12</b> .....	<b>21-179</b>
PCI-DDA04/12 Analog Output (D/A) .....	<b>21-179</b>
PCI-DDA04/12 Digital Input .....	<b>21-181</b>
PCI-DDA04/12 Digital Output .....	<b>21-182</b>
<b>PCI-DDA04/16</b> .....	<b>21-185</b>
PCI-DDA04/16 Analog Output (D/A) .....	<b>21-185</b>
PCI-DDA04/16 Digital Input .....	<b>21-187</b>
PCI-DDA04/16 Digital Output .....	<b>21-188</b>
<b>PCI-DDA08/12</b> .....	<b>21-191</b>
PCI-DDA08/12 Analog Output (D/A) .....	<b>21-191</b>
PCI-DDA08/12 Digital Input .....	<b>21-193</b>
PCI-DDA08/12 Digital Output .....	<b>21-194</b>
<b>PCI-DDA08/16</b> .....	<b>21-197</b>
PCI-DDA08/16 Analog Output (D/A) .....	<b>21-197</b>
PCI-DDA08/16 Digital Input .....	<b>21-199</b>
PCI-DDA08/16 Digital Output .....	<b>21-200</b>
<b>PCI-DIO24</b> .....	<b>21-203</b>
PCI-DIO24 Digital Input .....	<b>21-203</b>
PCI-DIO24 Digital Output .....	<b>21-204</b>
PCI-DIO24 Signal Conditioning .....	<b>21-206</b>
<b>PCI-DIO24H</b> .....	<b>21-207</b>
PCI-DIO24H Digital Input .....	<b>21-207</b>
PCI-DIO24H Digital Output .....	<b>21-208</b>
<b>PCI-DIO48H</b> .....	<b>21-211</b>
PCI-DIO48H Digital Input .....	<b>21-211</b>
PCI-DIO48H Digital Output .....	<b>21-212</b>

<b>PCI-DIO96H</b> .....	<b>21-215</b>
PCI-DIO96H Digital Input .....	<b>21-215</b>
PCI-DIO96H Digital Output .....	<b>21-216</b>
<b>PCI-DIO96</b> .....	<b>21-219</b>
PCI-DIO96 Digital Input .....	<b>21-219</b>
PCI-DIO96 Digital Output .....	<b>21-220</b>
<b>PCI-PDISO8</b> .....	<b>21-223</b>
PCI-PDISO8 Digital Input .....	<b>21-223</b>
PCI-PDISO8 Digital Output .....	<b>21-225</b>
<b>PCI-PDISO16</b> .....	<b>21-226</b>
PCI-PDISO16 Digital Input .....	<b>21-226</b>
PCI-PDISO16 Digital Output .....	<b>21-228</b>
<b>PCIM-DAS1602/16</b> .....	<b>21-229</b>
PCIM-DAS1602/16 Analog Input (A/D) .....	<b>21-230</b>
PCIM-DAS1602/16 Analog Output (D/A) .....	<b>21-231</b>
PCIM-DAS 1602/16 Digital Input .....	<b>21-233</b>
PCIM-DAS1602/16 Digital Output .....	<b>21-234</b>
<b>PCIM-DDA06/16</b> .....	<b>21-236</b>
PCIM-DDA06/16 Analog Output (D/A) .....	<b>21-236</b>
PCIM-DDA06/16 Digital Input .....	<b>21-238</b>
PCIM-DDA06/16 Digital Output .....	<b>21-239</b>
<b>PCI-DUAL-AC5</b> .....	<b>21-242</b>
PCI-DUAL-AC5 Digital Input .....	<b>21-242</b>
PCI-DUAL-AC5 Digital Output .....	<b>21-243</b>
<b>PCI-QUAD04</b> .....	<b>21-246</b>
PCI-QUAD04 Incremental Encoder .....	<b>21-247</b>
PCI-QUAD04 Incremental Encoder (Obsolete) .....	<b>21-251</b>
<b>PCI-DAS-TC</b> .....	<b>21-254</b>
PCI-DAS-TC Thermocouple .....	<b>21-255</b>

<b>AT-AO-6</b> .....	<b>22-4</b>
AT-AO-6 Analog Output (D/A) .....	<b>22-4</b>
<b>AT-AO-10</b> .....	<b>22-6</b>
AT-AO-10 Analog Output (D/A) .....	<b>22-6</b>
<b>PC-DIO-24</b> .....	<b>22-8</b>
PC-DIO-24 Digital Input .....	<b>22-8</b>
PC-DIO-24 Digital Output .....	<b>22-9</b>
<b>PC-TIO-10</b> .....	<b>22-12</b>
PC-TIO-10 Digital Input .....	<b>22-12</b>
PC-TIO-10 Digital Output .....	<b>22-13</b>
PC-TIO-10 Counter PWM .....	<b>22-15</b>
PC-TIO-10 Counter PWM & ARM .....	<b>22-16</b>
PC-TIO-10 Counter FM .....	<b>22-17</b>
PC-TIO10 Counter FM & ARM .....	<b>22-19</b>
PC-TIO10 PWM Capture .....	<b>22-21</b>
PC-TIO10 FM Capture .....	<b>22-22</b>
PC-TIO-10xx .....	<b>22-22</b>
<b>PCI-6023E</b> .....	<b>22-23</b>
PCI-6023E Analog Input (A/D) .....	<b>22-24</b>
PCI-6023E Digital Input .....	<b>22-26</b>
PCI-6023E Digital Output .....	<b>22-27</b>
PCI-6023E Pulse Generation .....	<b>22-28</b>
PCI-6023E Pulse Width/Period Measurement .....	<b>22-29</b>
<b>PCI-6024E</b> .....	<b>22-31</b>
PCI-6024E Analog Input (A/D) .....	<b>22-32</b>
PCI-6024E Analog Output (D/A) .....	<b>22-34</b>
PCI-6024E Digital Input .....	<b>22-35</b>
PCI-6024E Digital Output .....	<b>22-36</b>
PCI-6024E Pulse Generation .....	<b>22-37</b>
PCI-6024E Pulse Width/Period Measurement .....	<b>22-38</b>

<b>PCI-6025E</b> .....	<b>22-40</b>
PCI-6025E Analog Input (A/D) .....	<b>22-41</b>
PCI-6025E Analog Output (D/A) .....	<b>22-43</b>
PCI-6025E and PCI-6025E 8255 Digital Input .....	<b>22-44</b>
PCI-6025E Digital Output .....	<b>22-45</b>
PCI-6025E Pulse Generation .....	<b>22-46</b>
PCI-6025E Pulse Width/Period Measurement .....	<b>22-47</b>
<b>PCI-6030E (Formerly PCI-MIO-16XE-10)</b> .....	<b>22-49</b>
PCI-6030E Analog Input (A/D) .....	<b>22-50</b>
PCI-6030E Analog Output (D/A) .....	<b>22-52</b>
PCI-6030E Digital Input .....	<b>22-54</b>
PCI-6030E Digital Output .....	<b>22-55</b>
PCI-6030E Pulse Generation .....	<b>22-56</b>
PCI-6030E Pulse Width/Period Measurement .....	<b>22-57</b>
<b>PCI-6031E</b> .....	<b>22-59</b>
PCI-6031E Analog Input (A/D) .....	<b>22-60</b>
PCI-6031E Analog Output (D/A) .....	<b>22-62</b>
PCI-6031E Digital Input .....	<b>22-64</b>
PCI-6031E Digital Output .....	<b>22-65</b>
PCI-6031E Pulse Generation .....	<b>22-66</b>
PCI-6031E Pulse Width/Period Measurement .....	<b>22-67</b>
<b>PCI-6040E (Formerly PCI-MIO-16E-4)</b> .....	<b>22-69</b>
PCI-6040E Analog Input (A/D) .....	<b>22-70</b>
PCI-6040E Analog Output (D/A) .....	<b>22-72</b>
PCI-6040E Digital Input .....	<b>22-74</b>
PCI-6040E Digital Output .....	<b>22-75</b>
PCI-6040E Pulse Generation .....	<b>22-76</b>
PCI-6040E Pulse Width/Period Measurement .....	<b>22-77</b>
<b>PCI/PXI-6052E</b> .....	<b>22-79</b>
PXI/PCI-6052E Analog Input (A/D) .....	<b>22-80</b>
PXI/PCI-6052E Analog Output (D/A) .....	<b>22-82</b>
PXI/PCI-6052E Digital Input .....	<b>22-84</b>
PXI/PCI-6052E Digital Output .....	<b>22-85</b>
PXI/PCI-6052E Pulse Generation .....	<b>22-86</b>
PXI/PCI-6052E Pulse Width/Period Measurement .....	<b>22-87</b>

<b>PCI-6070E (Formerly PCI-MIO-16E-1)</b> .....	<b>22-89</b>
PCI-6070E Analog Input (A/D) .....	<b>22-90</b>
PCI-6070E Analog Output (D/A) .....	<b>22-92</b>
PCI-6070E Digital Input .....	<b>22-94</b>
PCI-6070E Digital Output .....	<b>22-95</b>
PCI-6070E Pulse Generation .....	<b>22-96</b>
PCI-6070E Pulse Width/Period Measurement .....	<b>22-97</b>
<b>PCI-6071E</b> .....	<b>22-99</b>
PCI-6071E Analog Input (A/D) .....	<b>22-100</b>
PCI-6071E Analog Output (D/A) .....	<b>22-102</b>
PCI-6071E Digital Input .....	<b>22-104</b>
PCI-6071E Digital Output .....	<b>22-105</b>
PCI-6071E Pulse Generation .....	<b>22-106</b>
PCI-6071E Pulse Width/Period Measurement .....	<b>22-107</b>
<b>PCI-6503</b> .....	<b>22-109</b>
PCI-6503 Digital Input .....	<b>22-109</b>
PCI-6503 Digital Output .....	<b>22-110</b>
<b>PCI-6527</b> .....	<b>22-113</b>
PCI-6527 Digital Input .....	<b>22-113</b>
PCI-6527 Digital Output .....	<b>22-115</b>
<b>PCI-6601</b> .....	<b>22-117</b>
PCI-6601 Digital Input .....	<b>22-117</b>
PCI-6601 Digital Output .....	<b>22-118</b>
PCI-6601 Incremental Encoder .....	<b>22-120</b>
PCI-6601 Pulse Generation .....	<b>22-121</b>
PCI-6601 Pulse Width/Period Measurement .....	<b>22-122</b>
PCI-6601 Armed Pulse Generation .....	<b>22-124</b>
<b>PCI/PXI-6602</b> .....	<b>22-125</b>
PCI/PXI-6602 Digital Input .....	<b>22-125</b>
PCI/PXI-6602 Digital Output .....	<b>22-126</b>
PCI/PXI-6602 Incremental Encoder .....	<b>22-128</b>
PCI/PXI-6602 Pulse Generation .....	<b>22-129</b>
PCI/PXI-6602 Pulse Width/Period Measurement .....	<b>22-130</b>
PCI/PXI-6602 Armed Pulse Generation .....	<b>22-132</b>

<b>PCI-6703</b> .....	<b>22-134</b>
PCI-6703 Analog Output (D/A) .....	<b>22-134</b>
<b>PCI-6704</b> .....	<b>22-136</b>
PCI-6704 Analog Output (D/A) .....	<b>22-136</b>
<b>PCI-6711</b> .....	<b>22-138</b>
PCI-6711 Analog Output (D/A) .....	<b>22-138</b>
PCI-6711 Digital Input .....	<b>22-140</b>
PCI-6711 Digital Output .....	<b>22-141</b>
<b>PCI/PXI-6713</b> .....	<b>22-143</b>
PCI/PXI-6713 Analog Output (D/A) .....	<b>22-143</b>
PCI/PXI-6713 Digital Input .....	<b>22-145</b>
PCI/PXI-6713 Digital Output .....	<b>22-146</b>
<b>PCI-DIO-96</b> .....	<b>22-148</b>
PCI-DIO-96 Digital Input .....	<b>22-148</b>
PCI-DIO-96 Digital Output .....	<b>22-149</b>
<b>PXI-6040E</b> .....	<b>22-152</b>
PXI-6040E Analog Input (A/D) .....	<b>22-153</b>
PXI-6040E Analog Output (D/A) .....	<b>22-155</b>
PXI-6040E Digital Input .....	<b>22-157</b>
PXI-6040E Digital Output .....	<b>22-158</b>
PXI-6040E Pulse Generation .....	<b>22-159</b>
PXI-6040E Pulse Width/Period Measurement .....	<b>22-160</b>
<b>PXI-6070E</b> .....	<b>22-162</b>
PXI-6070E Analog Input (A/D) .....	<b>22-162</b>
PXI-6070E Analog Output (D/A) .....	<b>22-165</b>
PXI-6070E Digital Input .....	<b>22-166</b>
PXI-6070E Digital Output .....	<b>22-167</b>
PXI-6070E Pulse Generation .....	<b>22-169</b>
PXI-6070E Pulse Width/Period Measurement .....	<b>22-169</b>

<b>PXI-6071E</b> .....	<b>22-171</b>
PXI-6071E Analog Input (A/D) .....	<b>22-172</b>
PXI-6071E Analog Output (D/A) .....	<b>22-174</b>
PXI-6071E Digital Input .....	<b>22-176</b>
PXI-6071E Digital Output .....	<b>22-177</b>
PXI-6071E Pulse Generation .....	<b>22-178</b>
PXI-6071E Pulse Width/Period Measurement .....	<b>22-179</b>
<b>PXI-6508</b> .....	<b>22-181</b>
PXI-6508 Digital Input .....	<b>22-181</b>
PXI-6508 Digital Output .....	<b>22-182</b>
<b>PXI-6527</b> .....	<b>22-185</b>
PXI-6527 Digital Input .....	<b>22-185</b>
PXI-6527 Digital Output .....	<b>22-187</b>
<b>PXI-6704</b> .....	<b>22-189</b>
PXI-6704 Analog Output (D/A) .....	<b>22-189</b>

## **North Atlantic Industries, Inc. (Formerly Apex)**

# **23**

<b>PC-12SD (PC-77SD1)</b> .....	<b>23-2</b>
PC-12SD (PC-77SD1) Synchro/Resolver .....	<b>23-2</b>
<b>NAII (Apex) 73LD3</b> .....	<b>23-5</b>
73LD3 LVDT/RVDT Converter .....	<b>23-5</b>
<b>NAII (Apex) 73SD3</b> .....	<b>23-8</b>
NAII 73SD3 Synchro/Resolver .....	<b>23-9</b>
<b>NAII (Apex) 76LD1</b> .....	<b>23-12</b>
NAII 76LD1 L/D .....	<b>23-12</b>
<b>NAII (Apex) 76CL1</b> .....	<b>23-15</b>
NAII 76CL1 L/D .....	<b>23-15</b>
NAII 76CL1 D/L .....	<b>23-18</b>

<b>NAII (Apex) 76CS1</b> .....	<b>23-21</b>
NAII 76CS1 S/D .....	<b>23-21</b>
NAII 76CS1 D/S .....	<b>23-25</b>

## Quanser

### 24

<b>Q8</b> .....	<b>24-2</b>
Q8 Analog Input .....	<b>24-2</b>
Q8 Analog Output .....	<b>24-4</b>
Q8 Digital Input .....	<b>24-6</b>
Q8 Digital Output .....	<b>24-7</b>
Q8 Incremental Encoder .....	<b>24-8</b>
Q8 Counter .....	<b>24-11</b>

## Real Time Devices

### 25

<b>DM6420</b> .....	<b>25-2</b>
DM6420 Analog Input (A/D) .....	<b>25-3</b>
DM6420 Analog Output (D/A) .....	<b>25-5</b>
DM6420 Digital Input .....	<b>25-6</b>
DM6420 Digital Output .....	<b>25-7</b>
<b>DM6430</b> .....	<b>25-9</b>
DM6430 Analog Input (A/D) .....	<b>25-9</b>
DM6430 Analog Output (D/A) .....	<b>25-11</b>
DM6430 Digital Input .....	<b>25-12</b>
DM6430 Digital Output .....	<b>25-13</b>
<b>DM6604</b> .....	<b>25-15</b>
DM6604 Analog Output (D/A) .....	<b>25-15</b>
DM6604 Digital Input .....	<b>25-16</b>
DM6604 Digital Output .....	<b>25-17</b>



<b>DM6804</b> .....	<b>25-19</b>
DM6804 Digital Input .....	25-20
DM6804 Digital Output .....	25-20
DM6804 Counter PWM .....	25-21
DM6804 Counter PWM & ARM .....	25-23
DM6804 Counter FM .....	25-24
DM6804 Counter FM & ARM .....	25-26
DM6804 PWM Capture .....	25-27
DM6804 FM Capture .....	25-28
DM6804xx .....	25-29
<b>DM6814</b> .....	<b>25-30</b>
DM6814 Incremental Encoder .....	25-31
DM6814 Digital Input .....	25-31
DM6814 Digital Output .....	25-32
<b>DM6816</b> .....	<b>25-34</b>
DM6816 PWM .....	25-34
<b>DM7420</b> .....	<b>25-36</b>
DM7420 Analog Input (A/D) .....	25-36
DM7420 Digital Input .....	25-40
DM7420 Digital Output .....	25-40

## SBS Technologies

# 26

<b>Flex/104A PC/104 IP Carrier Board</b> .....	<b>26-2</b>
Flex-104A .....	26-2
<b>IP-16ADC</b> .....	<b>26-4</b>
IP-16ADC Analog Input (A/D) .....	26-4
<b>IP-16DAC</b> .....	<b>26-6</b>
IP-16DAC Analog Output (D/A) .....	26-6

<b>IP-DAC</b> .....	<b>26-8</b>
IP-DAC Analog Output (D/A) .....	<b>26-8</b>
<b>IP-Digital 24</b> .....	<b>26-10</b>
IP-Digital 24 Digital Input .....	<b>26-10</b>
IP-Digital 24 Digital Output .....	<b>26-11</b>
<b>IP-HiADC</b> .....	<b>26-13</b>
IP-HiADC Analog Input (A/D) .....	<b>26-13</b>
<b>IP-Synchro</b> .....	<b>26-15</b>
IP-Synchro .....	<b>26-15</b>
<b>IP-Unidig-E-48</b> .....	<b>26-17</b>
IP-Unidig-E-48 Digital Input .....	<b>26-17</b>
IP-Unidig-E-48 Digital Output .....	<b>26-18</b>
<b>PCI-40A Carrier Board</b> .....	<b>26-20</b>
PCI-40A .....	<b>26-20</b>
<b>Broadcast Memory</b> .....	<b>26-21</b>
Create Shared Memory Partitions .....	<b>26-21</b>
Initialize Shared Memory Nodes .....	<b>26-24</b>
SBS 2510/2500 Broadcast Memory .....	<b>26-25</b>
SBS25x0 init .....	<b>26-26</b>
SBS25x0 read .....	<b>26-27</b>
SBS25x0 write .....	<b>26-28</b>
Shared Memory Pack .....	<b>26-28</b>
Shared Memory Unpack .....	<b>26-29</b>
Shared Memory Structure Reference .....	<b>26-29</b>

**526** ..... 27-2

- Sensoray526 AD ..... 27-2
- Sensoray526 Dual AD ..... 27-3
- Sensoray526 DA ..... 27-4
- Sensoray526 Dual DA ..... 27-5
- Sensoray526 DI ..... 27-7
- Sensoray526 DO ..... 27-8
- Sensoray526 Encoder Input ..... 27-9

**626** ..... 27-11

- Sensoray 626 Initialize ..... 27-11
- Sensoray 626 Analog Input ..... 27-12
- Sensoray 626 Analog Output ..... 27-13
- Sensoray 626 Digital Input ..... 27-14
- Sensoray 626 Digital Output ..... 27-14
- Sensoray 626 Encoder ..... 27-15
- Sensoray 626 PWM Capture ..... 27-16

<b>Before You Start</b> .....	<b>29-2</b>
Create Shared Memory Partitions .....	29-2
Initialize Shared Memory Nodes .....	29-4
<b>SCRAMNet+ SC150 PCI</b> .....	<b>29-5</b>
SC150 init .....	29-5
SC150 read .....	29-6
SC150 write .....	29-7
Shared Memory Pack .....	29-8
Shared Memory Unpack .....	29-8
<b>Shared Memory Structure Reference</b> .....	<b>29-9</b>
Shared Memory Partition Structure .....	29-9
Shared Memory Node Initialization Structure .....	29-14

**United Electronic Industries (UEI)**

<b>Grouping the UEI Boards</b> .....	<b>30-4</b>
<b>Analog Input Frame Driver Blocks</b> .....	<b>30-6</b>
Notes on Master and Slave Boards .....	30-6
Interrupt Numbers .....	30-7
Interrupt Configuration .....	30-9
Example Models .....	30-11
<b>PD2-MF 12-Bit Series</b> .....	<b>30-13</b>
PD2-MF 12-Bit Series Analog Input (A/D) .....	30-14
PD2-MF 12-Bit Series Frame Analog Input .....	30-15
PD2-MF 12-Bit Series Analog Output (D/A) .....	30-19
PD2-MF 12-Bit Series Digital Input .....	30-20
PD2-MF 12-Bit Series Digital Output .....	30-21

<b>PD2-MF 14-Bit Series</b> .....	<b>30-23</b>
PD2-MF 14-Bit Series Analog Input (A/D) .....	<b>30-24</b>
PD2-MF 14-Bit Series Frame Analog Input .....	<b>30-25</b>
PD2-MF 14-Bit Series Analog Output (D/A) .....	<b>30-29</b>
PD2-MF 14-Bit Series Digital Input .....	<b>30-30</b>
PD2-MF 14-Bit Series Digital Output .....	<b>30-31</b>
<b>PD2-MF 16-Bit Series</b> .....	<b>30-33</b>
PD2-MF 16-Bit Series Analog Input (A/D) .....	<b>30-34</b>
PD2-MF 16-Bit Series Frame Analog Input .....	<b>30-35</b>
PD2-MF 16-Bit Series Analog Output (D/A) .....	<b>30-39</b>
PD2-MF 16-Bit Series Digital Input .....	<b>30-40</b>
PD2-MF 16-Bit Series Digital Output .....	<b>30-41</b>
<b>PD2-MFS 12-Bit Series</b> .....	<b>30-43</b>
PD2-MFS 12-Bit Series Analog Input (A/D) .....	<b>30-44</b>
PD2-MFS 12-Bit Series Frame Analog Input .....	<b>30-45</b>
PD2-MFS 12-Bit Series Analog Output (D/A) .....	<b>30-49</b>
PD2-MFS 12-Bit Series Digital Input .....	<b>30-50</b>
PD2-MFS 12-Bit Series Digital Output .....	<b>30-51</b>
<b>PD2-MFS 14-Bit Series</b> .....	<b>30-53</b>
PD2-MFS 14-Bit Series Analog Input (A/D) .....	<b>30-54</b>
PD2-MFS 14-Bit Series Frame Analog Input .....	<b>30-55</b>
PD2-MFS 14-Bit Series Analog Output (D/A) .....	<b>30-59</b>
PD2-MFS 14-Bit Series Digital Input .....	<b>30-60</b>
PD2-MFS 14-Bit Series Digital Output .....	<b>30-61</b>
<b>PD2-MFS 16-Bit Series</b> .....	<b>30-63</b>
PD2-MFS 16-Bit Series Analog Input (A/D) .....	<b>30-64</b>
PD2-MFS 16-Bit Series Frame Analog Input .....	<b>30-65</b>
PD2-MFS 16-Bit Series Analog Output (D/A) .....	<b>30-69</b>
PD2-MFS 16-Bit Series Digital Input .....	<b>30-70</b>
PD2-MFS 16-Bit Series Digital Output .....	<b>30-71</b>

<b>PDXI-MF 12-Bit Series</b> .....	<b>30-73</b>
PDXI-MF 12-Bit Series Analog Input (A/D) .....	<b>30-74</b>
PDXI-MF 12-Bit Series Frame Analog Input .....	<b>30-75</b>
PDXI-MF 12-Bit Series Analog Output (D/A) .....	<b>30-79</b>
PDXI-MF 12-Bit Series Digital Input .....	<b>30-80</b>
PDXI-MF 12-Bit Series Digital Output .....	<b>30-81</b>
<b>PDXI-MF 14-Bit Series</b> .....	<b>30-83</b>
PDXI-MF 14-Bit Series Analog Input (A/D) .....	<b>30-84</b>
PDXI-MF 14-Bit Series Frame Analog Input .....	<b>30-85</b>
PDXI-MF 14-Bit Series Analog Output (D/A) .....	<b>30-89</b>
PDXI-MF 14-Bit Series Digital Input .....	<b>30-90</b>
PDXI-MF 14-Bit Series Digital Output .....	<b>30-91</b>
<b>PDXI-MF 16-Bit Series</b> .....	<b>30-93</b>
PDXI-MF 16-Bit Series Analog Input (A/D) .....	<b>30-94</b>
PDXI-MF 16-Bit Series Frame Analog Input .....	<b>30-95</b>
PDXI-MF 16-Bit Series Analog Output (D/A) .....	<b>30-99</b>
PDXI-MF 16-Bit Series Digital Input .....	<b>30-100</b>
PDXI-MF 16-Bit Series Digital Output .....	<b>30-101</b>
<b>PDXI-MFS 12-Bit Series</b> .....	<b>30-103</b>
PDXI-MFS 12-Bit Series Analog Input (A/D) .....	<b>30-104</b>
PDXI-MFS 12-Bit Series Frame Analog Input .....	<b>30-105</b>
PDXI-MFS 12-Bit Series Analog Output (D/A) .....	<b>30-109</b>
PDXI-MFS 12-Bit Series Digital Input .....	<b>30-110</b>
PDXI-MFS 12-Bit Series Digital Output .....	<b>30-111</b>
<b>PDXI-MFS 14-Bit Series</b> .....	<b>30-113</b>
PDXI-MFS 14-Bit Series Analog Input (A/D) .....	<b>30-114</b>
PDXI-MFS 14-Bit Series Frame Analog Input .....	<b>30-116</b>
PDXI-MFS 14-Bit Series Analog Output (D/A) .....	<b>30-120</b>
PDXI-MFS 14-Bit Series Digital Input .....	<b>30-121</b>
PDXI-MFS 14-Bit Series Digital Output .....	<b>30-122</b>

<b>PDXI-MFS 16-Bit Series</b> .....	<b>30-124</b>
PDXI-MFS 16-Bit Series Analog Input (A/D) .....	<b>30-125</b>
PDXI-MFS 16-Bit Series Frame Analog Input .....	<b>30-126</b>
PDXI-MFS 16-Bit Series Analog Output (D/A) .....	<b>30-130</b>
PDXI-MFS 16-Bit Series Digital Input .....	<b>30-131</b>
PDXI-MFS 16-Bit Series Digital Output .....	<b>30-132</b>
<b>PD2-AO Series</b> .....	<b>30-134</b>
PD2-AO Analog Output (D/A) .....	<b>30-134</b>
PD2-AO Digital Input .....	<b>30-136</b>
PD2-AO Digital Output .....	<b>30-137</b>
<b>PD2-DIO-64</b> .....	<b>30-139</b>
PD2-DIO-64 Digital Input .....	<b>30-140</b>
PD2-DIO-64 Digital Output .....	<b>30-141</b>
<b>PD2-DIO-128</b> .....	<b>30-143</b>
PD2-DIO-128 Digital Input .....	<b>30-143</b>
PD2-DIO-128 Digital Output .....	<b>30-144</b>
<b>PD2-DIO-128i</b> .....	<b>30-146</b>
PD2-DIO-128i Digital Input .....	<b>30-146</b>
PD2-DIO-128i Digital Output .....	<b>30-147</b>
<b>PDL-DIO-64</b> .....	<b>30-149</b>
PDL-DIO-64 Digital Input .....	<b>30-150</b>
PDL-DIO-64 Digital Output .....	<b>30-151</b>
<b>PDXI-DIO-64</b> .....	<b>30-153</b>
PDXI-DIO-64 Digital Input .....	<b>30-154</b>
PDXI-DIO-64 Digital Output .....	<b>30-155</b>
<b>PDXI-AO Series</b> .....	<b>30-157</b>
PDXI-AO Analog Output (D/A) .....	<b>30-157</b>
PDXI-AO Digital Input .....	<b>30-159</b>
PDXI-AO Digital Output .....	<b>30-160</b>

## **xPC Target Support for Vector CANape**

---

### **31**

<b>Vector CANape</b> .....	<b>31-2</b>
Notes on xPC Target and Vector CANape .....	<b>31-3</b>
<b>Configuring xPC Target and Vector CANape</b> .....	<b>31-5</b>
Getting Started .....	<b>31-5</b>
Creating a new Vector CANape Project to Associate with a Particular Target Application .....	<b>31-7</b>
Associating an Existing Vector CANape Project with a Particular Target PC .....	<b>31-9</b>
Providing A2L Files for Vector CANape Database .....	<b>31-10</b>

## **Versalogic**

---

### **32**

<b>VSBC-6</b> .....	<b>32-2</b>
VSBC-6 Analog Input (A/D) .....	<b>32-2</b>
VSBC-6 Digital Input .....	<b>32-3</b>
VSBC-6 Digital Output .....	<b>32-4</b>
VSBC-6 Watch Dog .....	<b>32-4</b>



<b>Before You Start</b> .....	<b>33-2</b>
Create Shared Memory Partitions .....	<b>33-2</b>
Initialize Shared Memory Nodes .....	<b>33-4</b>
<b>VMICPCI-5565</b> .....	<b>33-6</b>
5565 init .....	<b>33-6</b>
5565 read .....	<b>33-7</b>
5565 write .....	<b>33-8</b>
5565 pack .....	<b>33-9</b>
5565 unpack .....	<b>33-9</b>
5565 broadcast .....	<b>33-9</b>
<b>Shared Memory Structure Reference</b> .....	<b>33-11</b>
Shared Memory Partition Structure .....	<b>33-11</b>
Shared Memory Node Initialization Structure .....	<b>33-13</b>

## Miscellaneous Blocks

<b>xPC Target Scope Block</b> .....	<b>34-3</b>
xPC Target Scope of Type Target Parameters .....	<b>34-3</b>
xPC Target Scope of Type Host Parameters .....	<b>34-6</b>
xPC Target Scope of Type File Parameters .....	<b>34-7</b>
<b>From xPC Target</b> .....	<b>34-10</b>
<b>To xPC Target</b> .....	<b>34-12</b>
<b>xPC Target From File</b> .....	<b>34-14</b>
File Format .....	<b>34-15</b>
Block parameters .....	<b>34-16</b>
<b>xPC Target Software Reboot</b> .....	<b>34-18</b>
Block parameters .....	<b>34-18</b>

<b>I/O Port Read</b> .....	<b>34-19</b>
<b>I/O Port Write</b> .....	<b>34-21</b>
<b>xPC Target TET</b> .....	<b>34-23</b>
<b>xPC Target Time</b> .....	<b>34-24</b>
<b>Asynchronous Event Support</b> .....	<b>34-25</b>
Adding an Asynchronous Event .....	<b>34-25</b>
Async IRQ Source Block .....	<b>34-28</b>
Async Rate Transition Block .....	<b>34-29</b>
Async Buffer Write and Read Blocks .....	<b>34-30</b>
Asynchronous Interrupt Examples .....	<b>34-31</b>

## Obsolated Drivers

# 35

<b>xPC Target Library of Obsolated Drivers</b> .....	<b>35-2</b>
<b>Burr-Brown</b> .....	<b>35-3</b>
PCI-20003M .....	<b>35-3</b>
PCI-20019M .....	<b>35-4</b>
PCI-20023M .....	<b>35-7</b>
PCI-20041C .....	<b>35-9</b>
PCI-20098C .....	<b>35-11</b>
<b>Gespac</b> .....	<b>35-15</b>
GESADA-1 .....	<b>35-15</b>
GESPIA-2A .....	<b>35-18</b>
<b>Measurement Computing (Computer Boards)</b> .....	<b>35-20</b>
CIO-QUAD02 Incremental Encoder (Obsolete) .....	<b>35-20</b>
CIO-QUAD04 Incremental Encoder (Obsolete) .....	<b>35-22</b>
PCI-QUAD04 Incremental Encoder (Obsolete) .....	<b>35-24</b>

# xPC Target I/O Library

---

xPC Target is a solution for prototyping, testing, and deploying real-time systems using standard PC hardware. In support of this, xPC Target allows you to add I/O blocks to your model. I/O blocks in xPC Target provide a particular function of an I/O board. By using I/O blocks in your model, you can generate executable code tuned specifically for your hardware. This chapter includes the following sections:

I/O Driver Blocks (p. 1-2)	Introduction to the xPC Target I/O library of driver blocks
Adding I/O Blocks with the xPC Target Library (p. 1-11)	Adding I/O blocks to a model using the xPC Target library
Adding I/O Blocks with the Simulink Library Browser (p. 1-15)	Adding I/O blocks to a model using the Simulink <sup>®</sup> library browser
Defining I/O Block Parameters (p. 1-19)	Configuring I/O driver blocks

## I/O Driver Blocks

You add I/O driver blocks to your Simulink model to connect your model to physical I/O boards. These I/O boards then connect to the sensors and actuators in the physical system. This section includes the following topics:

- “I/O Driver Block Library” on page 1-2
- “Memory-Mapped Devices” on page 1-5
- “PCI Bus I/O Devices” on page 1-6
- “xPC Target I/O Driver Structures” on page 1-7
- “Updated Driver Information” on page 1-10

Refer to the following sections for descriptions on how to add I/O blocks to your model, and how to configure those blocks:

- “Adding I/O Blocks with the xPC Target Library” on page 1-11
- “Adding I/O Blocks with the Simulink Library Browser” on page 1-15
- “Defining I/O Block Parameters” on page 1-19

### I/O Driver Block Library

A driver block does not represent an entire board, but an I/O section supported by a board. Therefore, the xPC Target library can have more than one block for each physical board. I/O driver blocks are written as C-code S-functions (noninlined S-functions). The source code for the C-code S-functions with xPC Target is included.

xPC Target supports PCI and ISA buses. If the bus type is not indicated in the driver block number, you can determine the bus type of a driver block by checking the block’s parameter dialog box. The last parameter is either a PCI slot, for PCI boards, or a base address, for ISA boards.

You can open the I/O device driver library with the MATLAB® command `xpclib`. The library `xpclib` contains sublibraries grouped by the type of I/O function they provide.

**Note** Opening a dialog box for a source block causes Simulink to pause. While Simulink is paused, you can edit the parameter values. You must close the dialog box to have the changes take effect and allow Simulink to continue.

In particular, hardware input blocks in the xPC Target library (blocks that acquire data from hardware) are affected by this change.

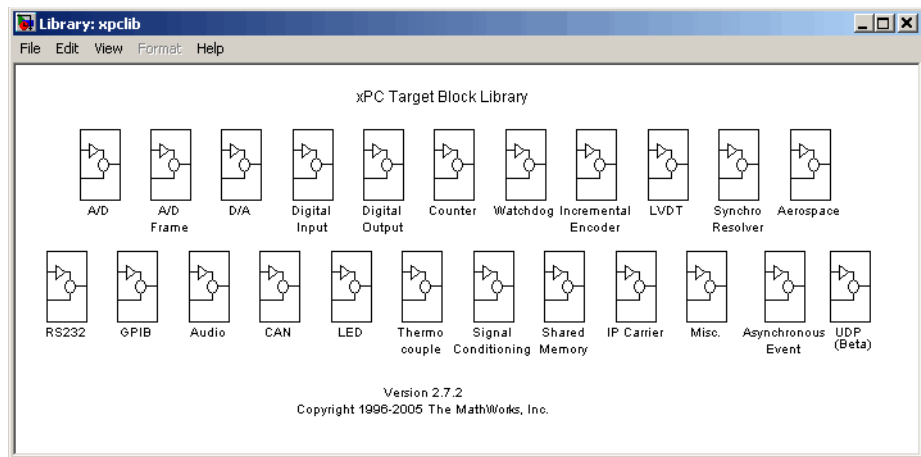

When you double-click one of these groups, the sublibrary opens, displaying a list grouped by manufacturer as shown below.

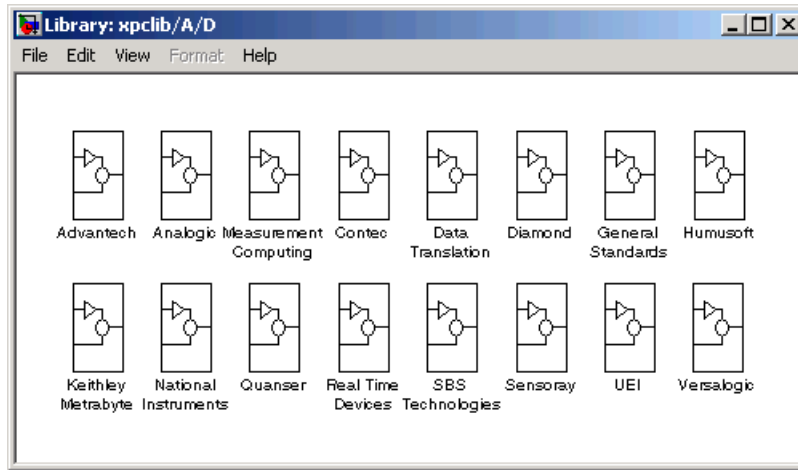

Double-clicking one of the manufacturer groups then displays the set of I/O device driver blocks for the specified I/O functionality (for example, A/D, D/A, Digital Inputs, Digital Outputs, and so on).

The following figure shows the A/D drivers for the manufacturer Measurement Computing, Inc.

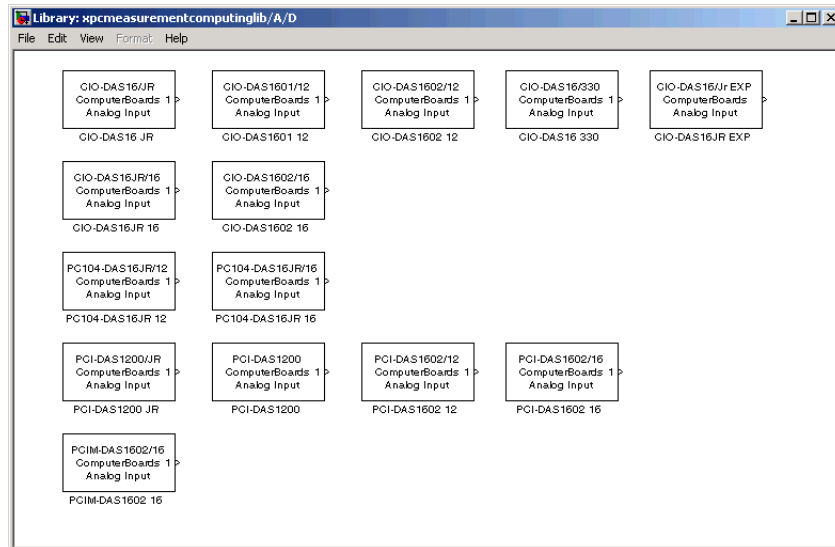

When you double-click one of these blocks, a Block Parameters dialog box opens, allowing you to enter hardware-specific parameters. Parameters typically include

- Sample time
- Number of channels
- Voltage range
- PCI slot (PCI boards)
- Base address (ISA boards)

## Memory-Mapped Devices

Some supported boards in the xPC Target I/O library are memory-mapped devices, for example, Burr-Brown boards. These memory-mapped boards are accessed in the address space between 640 K and 1 MB in the lower memory area. xPC Target reserves a 112 KB memory space for memory-mapped devices in the address range

C0000 - DBFFF

Some drivers for memory-mapped devices allow you to select an address range supported by the device, but not supported by xPC Target. For example, the CAN drivers for Softing allow you to select memory ranges above DBFFF. Base addresses of memory-mapped devices must be chosen within this memory space for your target application to work properly. Select a memory range supported by both the device and xPC Target.

## ISA Bus I/O Devices

There are two types of ISA boards:

- Jumper addressable ISA cards
- PnP (Plug and Play) ISA cards

xPC Target only supports jumper addressable ISA cards (non-PnP ISA boards) where you have to set the base address manually.

## PCI Bus I/O Devices

The xPC Target I/O library supports I/O boards with a PCI bus. During the boot process, the BIOS creates a conflict-free configuration of base addresses and interrupt lines for all PCI devices in the target system. The user does not need to define any base address information in the dialog boxes of the drivers.

All PCI device driver blocks have an additional entry in their dialog boxes. This entry is called `PCI Slot (-1 Autodetect)` and allows you to use several identical PCI boards within one target system. This entry uses a default value of `-1`, which allows the driver to search the entire PCI bus to find the board. If you specify a single number, `X`, greater than `0`, the driver uses the board in bus `0`, slot `X`. When more than one board of the same type is found, you must use a designated slot number and avoid the use of autodetection. For manually setting the slot number you use a number greater than or equal to `0`. If the board is not able to locate this slot in the target PC, your target application will generate an error message after downloading.

If this additional entry is set to any value equal to or greater than `0`, you must be aware of the manufacturer's identification number (Vendor ID) and the board identification number (Device ID) of those boards supported by the I/O library. When the target is booted, the BIOS is executed and the target PC monitor shows parameters for any PCI boards installed on the target PC. An example is shown below:

Bus No	Device No.	Func. No.	Vendor ID	Device ID	Device Class	IRQ
0	4	1	8086	7111	IDE controller	14/15
0	4	2	8086	7112	Serial bus controller	10
0	11	0	1307	000B	Unknown PCI device	N/A
1	0	0	12D2	0018	Display controller	11

In this example, the third line indicates the location of the Measurement Computing PCI-DIO48 board. This is known since the Measurement Computing vendor ID is `0x1307` and the device ID is `0xb`. In this case, you now can see that the Measurement Computing board is plugged into PCI slot `11` (Device No.), and that this value must be entered in the dialog box entry in your I/O device driver for each model that uses this I/O device.



## xPC Target I/O Driver Structures

Properties for xPC Target I/O drivers are usually defined using the parameter dialog box associated with each Simulink block. However, for more advanced drivers, the available fields defined by text boxes, check boxes, and pull-down lists are inadequate to define the behavior of the driver. In such cases, a more textual description is needed to indicate what the driver has to do at runtime. *Textual* in this context refers to a programming-language-like syntax and style.

xPC Target currently uses a string description contained in message structures for the conventional RS-232, GPIB, CAN (initialization), and the general counter drivers (AMD9513).

**What is a message structure?** — A message structure is a MATLAB array with each cell containing one complete message (command). A message consists of one or more statements.

First message      Second message      Third message

Message(1).field	Message(1).field	Message(1).field
Message(1).field	Message(1).field	Message(1).field
Message(1).field	Message(1).field	Message(1).field

**Syntax of a message statement** — Each statement in a message has the following format:

```
Structure_name(index).field_name = <field string or value>
```

The field names are defined by the driver, and need to be entered with the correct upper- and lowercase letters. However, you can choose your own structure name and enter that name into the driver parameter dialog box.

**Creating a message structure** — You could enter the message structure directly in the edit field of the driver parameter dialog box. But because the message structure is an array and very large, this becomes cumbersome very easily.

A better way is to define the message structure as an array in an M-file and pass the structure array to the driver by referencing it by name. For example, to initialize an external A/D module and acquire a value during each sample interval, create an M-file with the following statements:

```
Message(1).senddata='InitADConv, Channel %d'  
Message(1).inputports=[1]  
Message(1).recdata=''  
Message(1).outputports=[]  
  
Message(2).senddata='Wait and Read converted Value'  
Message(2).inputports=[]  
Message(2).recdata='%f'  
Message(2).outputports=[1]
```

This approach is different from other xPC Target driver blocks:

- The M-file containing the definition of the message structure has to be executed before the model is opened.

After creating your Simulink model and message M-file, set the preload function of the Simulink model to load the M-file the next time you open the model. In the MATLAB window, type

```
set_param(gcs, 'PreLoadFcn', 'M-file_name')
```

- When you move or copy the model file to a new directory, you also need to move or copy the M-file defining the message structure.

During each sample interval, the driver block locates the structure defined in the Block Parameters dialog box, interprets the series of messages, and executes the command defined by each message.

**Specific drivers and structures** — For detailed information on the fields in a message structure, see the following chapters in this document:

- Chapter 2, “Serial Communications Support”
- Chapter 3, “GPIB I/O Support”
- Chapter 4, “CAN I/O Support”

## **PWM and FM Driver Block Notes**

In PWM and FM driver blocks, your control over the output frequency and duty cycle is not always precise. In particular, these values are affected by the way that the base frequency is selected, as described in this section. The base frequency value is exact.

At the beginning of each sample time, two unsigned 16-bit integers,  $n$  and  $m$ , are computed based on the block parameters and the current values of the input signals. During the current sample period, the output signal is held high for  $m$  cycles of the base frequency, low for the next  $n-m$  cycles, high for the next  $m$  cycles, and so forth.

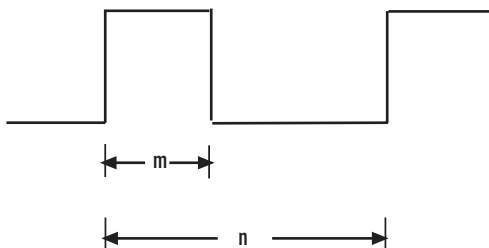

For a base frequency  $b$ , this results in a rectangular output signal of frequency  $b/n$  and duty cycle  $m/n$ . Because  $m$  and  $n$  must be integers, it is not possible to provide a continuous range of output frequencies and duty cycles with perfect exactness.

For example, assume that you want to configure an FM block with a duty cycle ( $m/n$ ) of  $1/2$ . The input signal  $f$  to this block is a relative frequency. It specifies an output frequency of  $b \times f$ . Because  $m$  and  $n$  must be integers, it is not always possible to find values of  $m$  and  $n$  such that  $f$  will equal  $b/n$  exactly and  $n$  will equal  $2 \times m$  (duty cycle  $m/n = 1/2$ ) exactly. Such an exact match is only possible when the input signal  $f$  equals  $1/4$ ,  $1/6$ ,  $1/8$ , and so forth. The output frequencies for the intervening input signal  $f$  values are approximate. The errors are smaller as  $f$  approaches 0 and larger as  $f$  approaches 1.

Hint, to achieve the smallest margin of error, select the largest possible base frequency. The fact that  $n$  and  $m$  must be 16-bit integers imposes a lower limit of  $b / (2^{16} - 1)$  on the frequencies that can be generated using a given base frequency.

## **Updated Driver Information**

Because new drivers are always being added, and existing drivers are always being updated, not all of the information about these drivers is included in the online or printed documentation.

For updated and additional driver information, see the developer Web site at

<http://www.mathworks.com/support/product/XP/productnews/productnews.html>

## Adding I/O Blocks with the xPC Target Library

xPC Target includes a Simulink block library for I/O drivers. The highest hierarchical level in the library is grouped by I/O function. The second level is grouped by board manufacturer. The manufacturer groups within this second level contain the driver blocks for specific boards.

This procedure uses the Simulink model `xpc_osc.mdl` as an example of how to add and connect I/O blocks:

- 1 In the MATLAB window, type

```
xpclib
```

The **Library: xpclib** window opens.

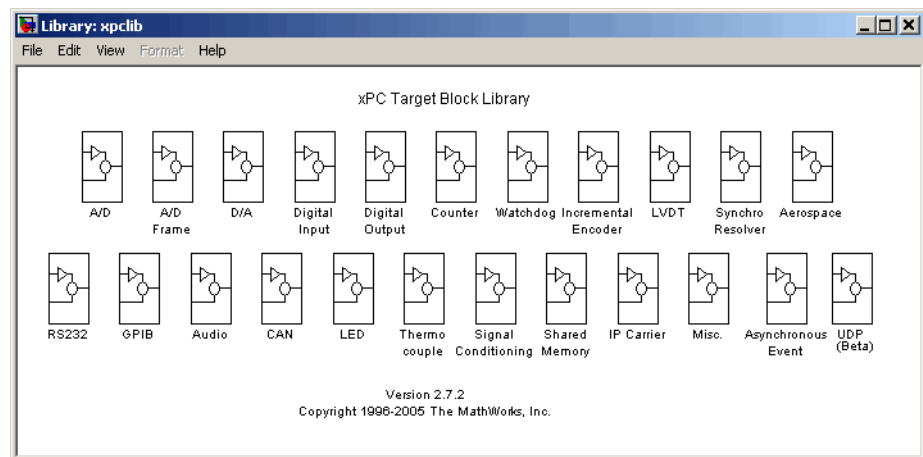

Alternatively, you can access the I/O driver library with the Simulink Library Browser. See “Adding I/O Blocks with the Simulink Library Browser” on page 1-15.

- 2 Open a function group. For example, to open the A/D group, double-click the A/D block.

The manufacturer level opens.

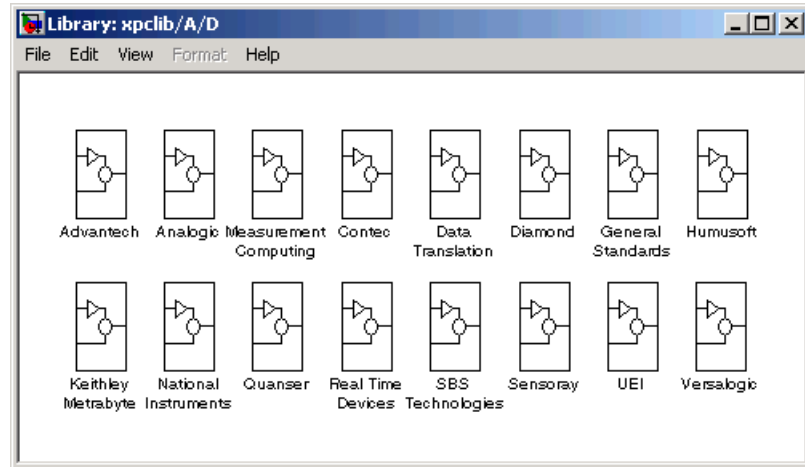

Within each manufacturer group are the blocks for a single function.

- 3 Open a manufacturer group. For example, to open the A/D driver blocks from Measurement Computing, double-click the group marked Measurement Computing.

The window with the A/D driver blocks for Measurement Computing opens.

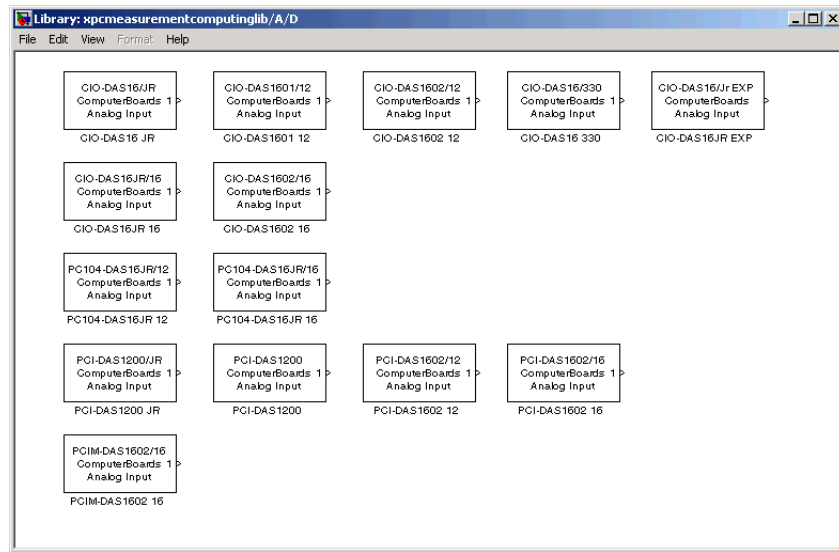

4 In the Simulink window, type

`xpc_osc`

The Simulink block diagram opens for the model `xpc_osc.mdl`.

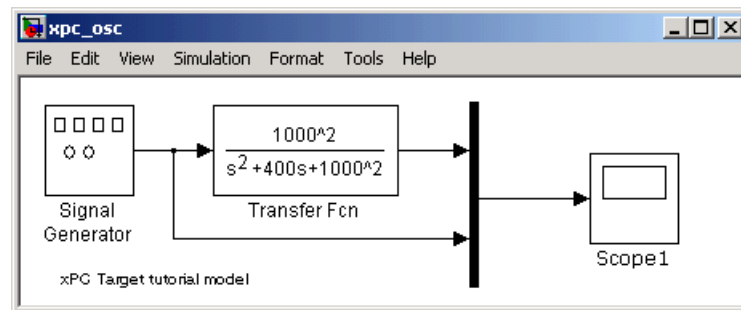

5 From the block library, click and drag the name of an A/D board to the Simulink block diagram. Likewise, click and drag the name of a D/A board to your model.

Simulink adds the new I/O blocks to your model.

- 6 Remove the Signal Generator block and add the Analog Input block in its place. Remove the Scope block and add the Analog Output block in its place.

The demo model xpcosc should look like the figure shown below.

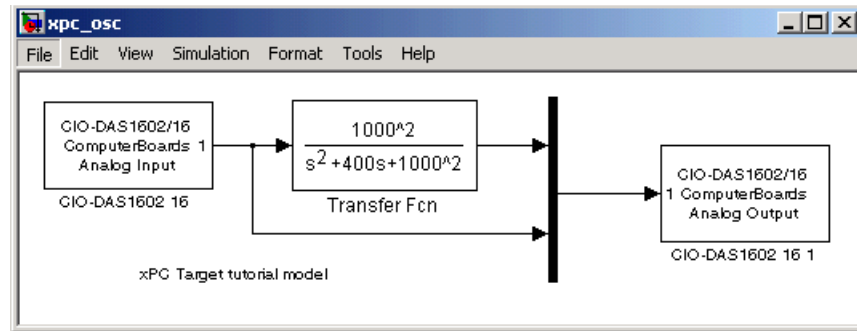

You cannot run this model unless you have the I/O board shown installed in your target PC. However, you can substitute the driver blocks for another I/O board that is installed in the target PC.

Your next task is to define the I/O block parameters. See “Defining I/O Block Parameters” on page 1-19.



## Adding I/O Blocks with the Simulink Library Browser

xPC Target includes a Simulink block library for I/O drivers. The highest hierarchical level in the library is grouped by I/O function. The second level is grouped by board manufacturer. The manufacturer groups within this second level contain the driver blocks for specific boards.

This procedure uses the Simulink model `xpc_osc.mdl` as an example of how to add and connect I/O blocks:

- 1 In the MATLAB window, type

```
xpc_osc
```

The Simulink block diagram opens for the model `xpc_osc.mdl`.

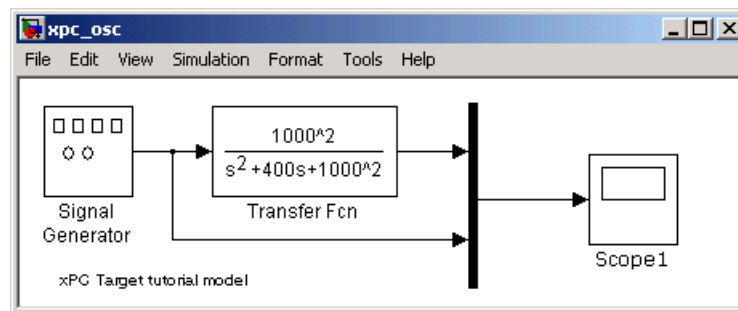

- 2 In the Simulink window, from the **View** menu, click **Library Browser**.

The Simulink Library Browser window opens. Alternatively, you can open the Simulink Library Browser by typing `simulink` in the MATLAB Command Window.

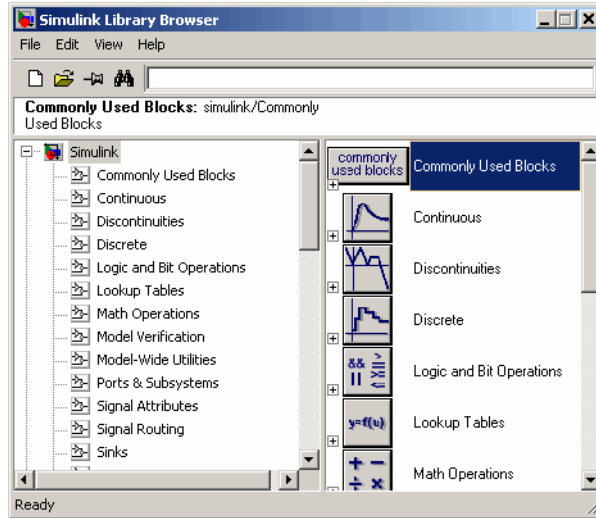

You can access the xPC Target I/O library by right-clicking **xPC Target** and then clicking **Open the xPC Target Library**.

Alternatively, you can access driver blocks using the xPC Target I/O driver library. See “Adding I/O Blocks with the xPC Target Library” on page 1-11.

- 3 Double-click **xPC Target**.

A list of I/O functions opens.

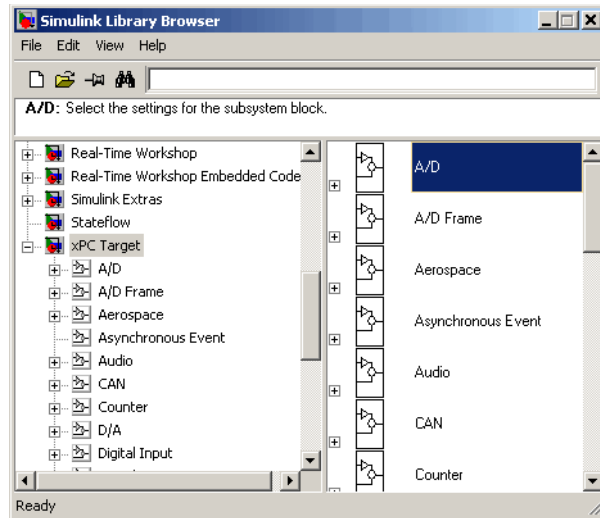

- 4 Open a function group. For example, to open the A/D group for Measurement Computing, double-click A/D, and then click Measurement Computing.

A list with the A/D driver blocks for Measurement Computing opens.

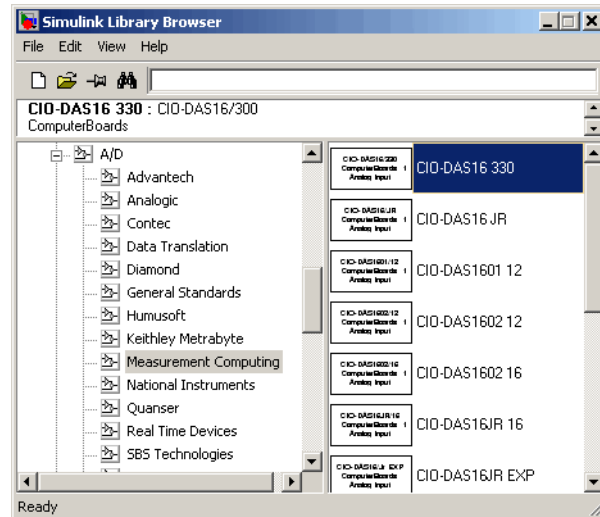

- 5 From the block library, click and drag the name of an A/D board to the Simulink block diagram. Likewise, click and drag the name of a D/A board to your model.

Simulink adds the new I/O blocks to your model.

- 6 Remove the Signal Generator block and add the analog input block in its place. Remove the Scope block and add the analog output block in its place.

The model xpc\_osc should look like the figure shown below.

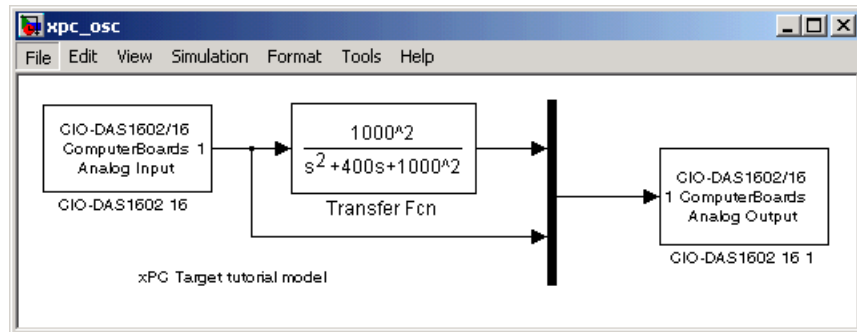

You cannot run this model unless you have the I/O board shown above installed in your target PC. However, you can substitute the driver blocks for another I/O board that is installed in the target PC.

Your next task is to define the I/O block parameters. See “Defining I/O Block Parameters.”

## Defining I/O Block Parameters

The I/O block parameters define values for your physical I/O boards. For example, I/O block parameters include channel numbers for multichannel boards, input and output voltage ranges, and sample time.

This procedure uses the Simulink model `xpc_osc.mdl` as an example, and assumes you have added an analog input and an analog output block to your model. To add an I/O block, see either “Adding I/O Blocks with the xPC Target Library” on page 1-11 or “Adding I/O Blocks with the Simulink Library Browser.”

- 1 In the Simulink window, double-click the input block labeled **Analog Input**.

The dialog box for the A/D converter opens.

- 2 Fill in the dialog box. For example, for a single channel enter 1 in the **Number of Channels** box, select  $-10\text{ V}$  for the input range, and select single-ended (16 channels) for the MUX switch position. Enter the same sample time you entered for the fixed step size in the Simulation -> Configuration Parameters dialog box **Solver** pane. Enter the base address for this ISA-bus board.

The Block Parameters dialog box should look similar to the figure shown below.

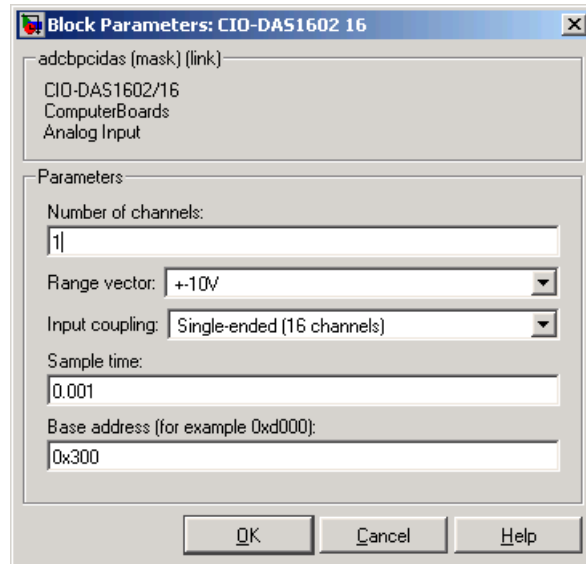

- 3 In the Simulink window, double-click the output block labeled **Analog Output**.

The dialog box for the D/A converter opens.

- 4 Fill in the dialog box. For example, for one channel enter [1] in the **Channel Vector** box; for an output level of  $-10$  V enter the code [-10] in the **Range Vector** box. Enter the same sample time you entered for the fixed step size in the Simulation -> Configuration Parameters dialog box **Solver** pane. Enter the base address for this ISA-bus board. E

The Block Parameters dialog box should look similar to the figure shown below.

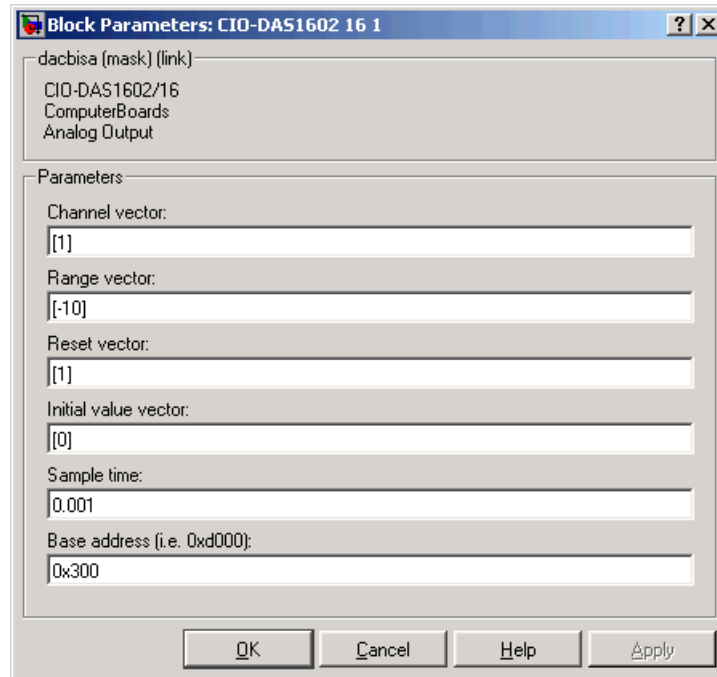

If you change the sample time by changing the target object property `SampleTime`, the sample times you entered in both of the I/O blocks are set to the new value. The step size you entered in the Configuration Parameters dialog box remains unchanged.

Your next task is to build and run the target application. See “xPC Target Application” in Chapter 3 of the xPC Target getting started documentation.





# Serial Communications Support

---

xPC Target interfaces the target PC to serial devices using either the COM1 or COM2 port of the main board, through Quatech drivers, or through Diamond Systems drivers. This chapter includes the following sections:

Introduction to Serial Drivers (p. 2-2)	Description of hardware connections and host/target PC communications.
xPC Target RS-232 and 422/485 Drivers (Composite) (p. 2-5)	Description of composite xPC Target RS-232/422/485 drivers. Includes description of procedure to add an RS-232 driver block to your Simulink model. Also describes associated Simulink blocks.
xPC Target RS-232 Drivers (Conventional) (p. 2-60)	Description of conventional xPC Target RS-232 drivers. Includes description of procedures to add an RS-232 driver block to your Simulink model and create the message structures associated with those blocks. Also describes associated Simulink blocks and MATLAB message structures associated with the Simulink blocks.

# Introduction to Serial Drivers

xPC Target supports RS-232 I/O communication with the following:

- Serial ports on the target PC
- Third-party Quatech PCI boards (<http://www.quatech.com>)
- Third-party Diamond Systems PC/104 boards (<http://www.diamondsystems.com>)

For the target PC serial ports, xPC Target can use these ports as the RS-232 I/O devices. You can initiate RS-232 communications with these ports and the accompanying xPC Target drivers.

xPC Target also supports the following:

- RS-232 — QSC-100 and ESC-100 PCI boards from Quatech
- RS-422, RS-485 — QSC-200/300 PCI boards and DSCP-200/300 dual channel PXI boards from Quatech, Fastcom: 422/2-PCI-335 adapter from Commtech
- RS-232, RS-422, RS-485 — Emerald-MM and Emerald-MM-8 PC/104 boards from Diamond Systems. These boards provide 4 and 8 serial ports, respectively. These boards are jumper-configurable for the protocols (see the manufacturer documentation for details).

xPC Target provides a set of functionally similar drivers for these boards. See “RS-232/422/485 Simulink Block Reference” on page 2-12 for a description of the driver blocks that support the different protocols.

xPC Target supplies two types of drivers to support RS-232 I/O communication, conventional and composite:

- The composite drivers support RS-232 I/O for the target PC serial ports, the Quatech RS-232, RS-422, and RS-485 I/O devices, and the Diamond Systems RS-232 I/O devices. These drivers support communication in asynchronous binary mode. xPC Target uses Simulink blocks for the I/O drivers. The composite drivers provide a simple ASCII encode/decode for the send and receive RS-232, RS-422, and RS-485 blocks. This set of drivers has the descriptive name “composite” because the driver represents each functional piece of the driver as a Simulink block. For more precise behavior, you can customize the RS-232 driver with these blocks.

- The conventional drivers support RS-232 I/O only for the target PC serial ports. These drivers support synchronous, asynchronous, and binary (asynchronous) communication mode. xPC Target uses a model for this RS-232 I/O that includes both Simulink blocks for the I/O drivers and MATLAB structures for sequencing messages and commands.

This section includes the following topics:

- “Hardware Connections for RS-232” on page 2-3 — Connect the target PC to an RS-232 device.
- “Host and Target PC Communication” on page 2-3 — Consider limitations to using RS-232 for I/O on the target PC when using RS-232 communication between the host PC and target PC.

## Hardware Connections for RS-232

xPC Target supports serial communication with the COM1 and COM2 ports on the target PC.

Your target applications can use these RS-232 ports as I/O devices. Typically, the target PC is connected to an RS-232 device with a NULL modem cable. However, this depends on the DTE/DCE configuration of the devices, and you might not use a NULL modem cable.

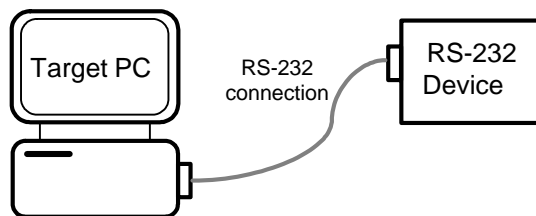

## Host and Target PC Communication

If the host PC and target PC are connected using serial communication, one COM port on the target PC is dedicated for communication with the host PC. You cannot use this COM port in your block diagram as an I/O device.

For example, if the target PC uses COM1 for the communication with the host PC, COM1 cannot be used by your block diagram. If you try to use COM1 as an I/O device in your block diagram, an error message is displayed. The error

message appears when you attempt to build and download the target application. In this example, you must use COM2 as an I/O device in your block diagram.

If you are using TCP/IP as your host PC to target PC communications protocol, then you can use any of the COM ports for RS-232 I/O.

---

**Note** When you use composite driver blocks, COM1 and COM3 often share interrupt line 4. Similarly, COM2 and COM4 often share interrupt line 3. If you use COM1 for host-target communication, you cannot also use COM1 or COM3 in a model. This is because the shared interrupt is caught in the xPC Target operating system. However, if COM3 uses an interrupt different from that for COM1, you can use COM3 in a model while using COM1 for host-target communications. If COM1 and COM3 share an interrupt line, you can use COM2 or COM4 as your RS-232 I/O port.

---

## xPC Target RS-232 and 422/485 Drivers (Composite)

This section describes the components that make up the RS-232 and RS-422/485 composite drivers, and how you can create a model using these drivers. These drivers perform RS-232 or RS-422/485 asynchronous communications.

xPC Target supports the target PC serial ports (main board), Quatech RS-232/422/485 devices, Diamond Systems RS-232 devices, and Commtech Fastcom: 422/2-PCI-335 adapters with composite drivers. These drivers distribute the functionality of the device across several subsystems and blocks. For most RS-232/422/485 requirements, you can use these RS-232/422/485 drivers as they are implemented. However, if you need to customize the xPC Target RS-232/422/485 drivers, the composite nature of the target PC serial port, Quatech RS-232/422/485, Diamond Systems RS-232, and Commtech Fastcom drivers enables you to do so. See “RS-232/422/485 Internal Blocks and Subsystems” on page 2-49 for details.

Note the following characteristics of the Commtech Fastcom: 422/2-PCI-335 adapter boards:

- The Fastcom 422/2-PCI-335 board has only two independent RS-422 channels.
- The Fastcom 422/2-PCI-335 board can handle baud rates up to 1.5 megabaud.
- The Fastcom 422/2-PCI-335 board hardware FIFO is fixed at 128 bytes for receive and transmit.

This section includes the following topics:

- “Adding RS-232 Blocks” on page 2-6
- “Building and Running the Target Application (Composite)” on page 2-11
- “RS-232/422/485 Simulink Block Reference” on page 2-12

---

**Note** Many of the blocks that support the RS-232 and RS-422/485 composite drivers are common across the main board, Quatech, and Diamond Systems boards. The descriptions for these blocks are applicable for all drivers, with specific board notes as appropriate.

---

### Adding RS-232 Blocks

You add RS-232 subsystem blocks to your Simulink model when you want to use the serial ports on the target PC, Quatech QSC-100 or ESC-100, or Diamond Systems Emerald-MM or Emerald-MM-8 serial device connected to the target PC, for I/O.

After you create a Simulink model, you can add xPC Target driver blocks and configure those blocks. The following procedure describes how to use the serial ports on the target PC for I/O with the composite drivers.

Before you start, decide what COM port combinations you want to use. The example has you configure the Baseboard Send/Receive block. To properly configure this block, you need to select serial port pairs. This parameter specifies the ports for which you are defining transmit and receive. You have a choice of the following:

- Com1 / none
- Com2 / none
- Com1 / Com3
- Com2 / Com4
- none / Com3
- none / Com4
- Custom

If you choose either the Com1 / Com3 or Com2 / Com4 pair, check that the port pair shares an interrupt. If the port pair does not share an interrupt, you cannot use the two ports as a pair.

Alternatively, you can define a Custom port pair. A Custom port pair is one that does not match the existing combinations of port pairs. When you select Custom, the dialog allows you to configure your own port pair. For example, you can set the IRQ and two addresses for the port pair. If one of the ports is not used, set that address to 0.

Normally, the ports are set to the following:

COM1 — 0x3F8, IRQ 4

COM2 — 0x2F8, IRQ 3

COM3 — 0x3E8 (if present), IRQ 4

COM4 — 0x2E8 (if present), IRQ 3

A Custom port pair is one where one or both ports of the pair are set to addresses other than these conventions, or one for which you want to assign a different IRQ value. Some hardware allows you to set the IRQ numbers independently.

If you choose the port pairs Com1/Com3 or Com2/Com4, you need to include one Send/Receive subsystem block in the model. If you choose to use COM1 and COM2, or COM1 and a custom port pair, you need to include two Send/Receive blocks in the model.

The following example shows two models, one that uses a standard Com1/Com3 port pair, and one that uses custom port pairs:

- 1 In the MATLAB Command Window, type

```
xpclib
```

The xPC Target driver block library opens.

- 2 Double-click the RS-232 group block.

A window with blocks for RS-232 drivers opens.

---

**Note** This library contains two sections, composite and conventional.

---

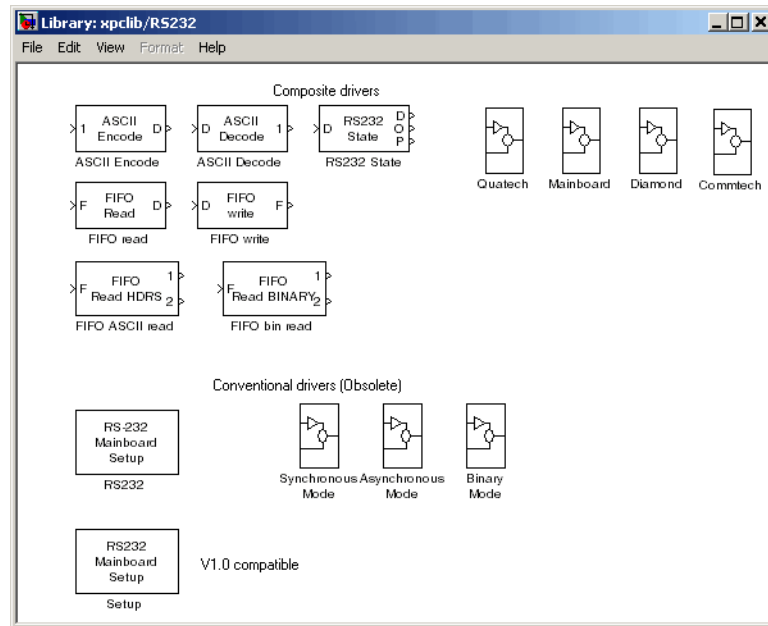

Alternatively, you can access the xPC Target block library from the Simulink Library Browser. In the Simulink window, and from the **View** menu, click **Show Library Browser**. In the left pane, double-click **xPC Target**, and then click **RS232**.

- 3 Drag and drop an ASCII Encode block to your Simulink model. This block encodes input for the RS-232 Send Receive block.
- 4 Configure this block.
- 5 Drag and drop an ASCII Decode block to your Simulink model. This block decodes output from the RS-232 Send Receive block.
- 6 Configure this block.
- 7 Double-click the Mainboard group block.
- 8 Depending on your port pair configuration, drag and drop one or two Baseboard RS-232 Send/Receive blocks to your Simulink model.



- 9 Double-click the Baseboard RS-232 Send/Receive block.
- 10 Configure this block. Pay particular attention to the **Parameter** group Board Setup entry.
- 11 Add a Signal Generator and Target Scope block.
- 12 From the Simulink Library Browser, select **Sinks**. Depending on your configuration, drag and drop one or more Terminator blocks. Connect this block to the unused RCV1 port to suppress unused port messages.
- 13 From the Simulink Library Browser, select **Sources**. Depending on your configuration, drag and drop the Ground block. Connect this block to the unused XMT3 port to suppress unused port messages.

Your model should look similar to one of the following figures. The first figure shows a single-block model. This model uses the Com1 / Com3 port pair. The second figure shows a two-block model. This model uses two sets of Custom port pairs.

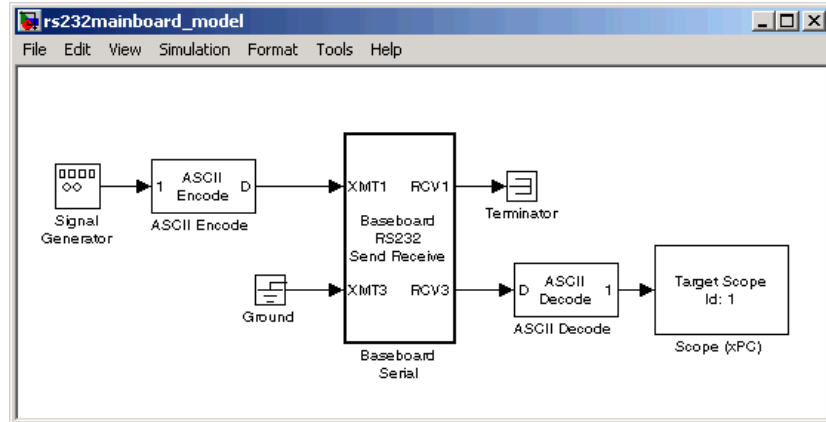

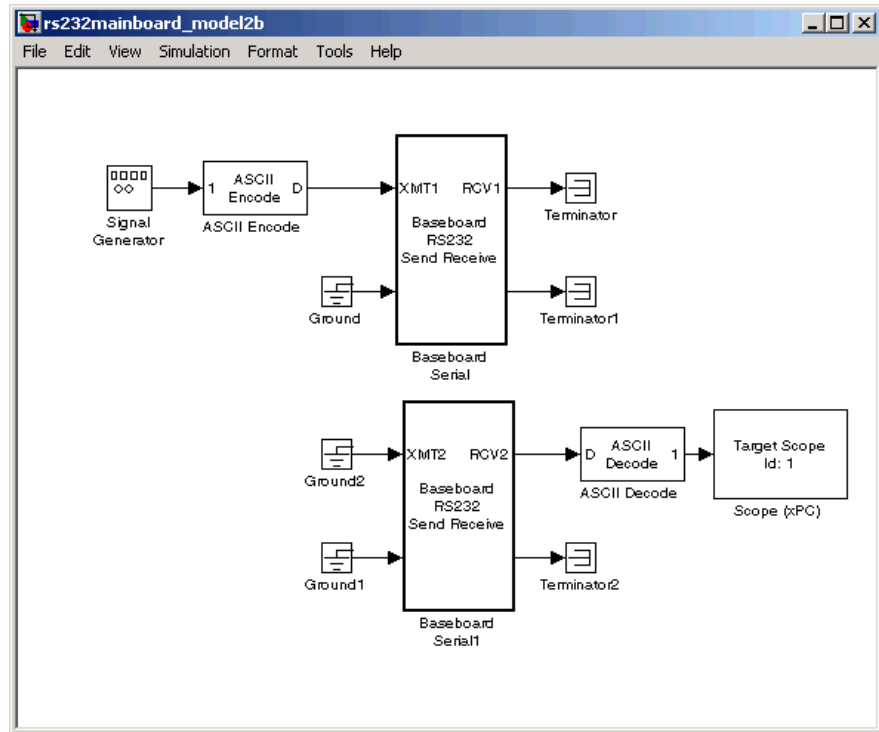

- 14 Double-click a Baseboard RS232 Send Receive block. Enter values to configure the port(s) on the target PC for this board.

For example, if the target PC is connected to COM1, your Send Receive block dialog box should look similar to the following figure. Note, this is a dynamic dialog box that changes depending on the **Parameter group** selection.

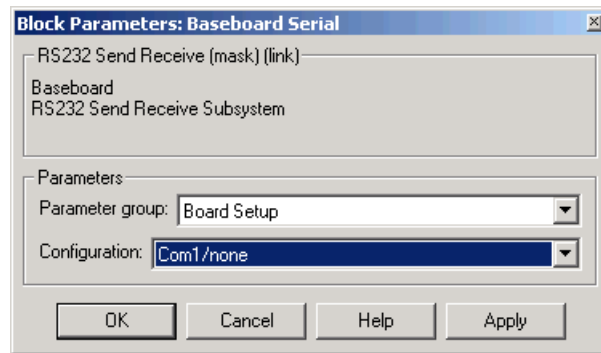

For more information on entering the block parameters, see “Send/Receive Blocks” on page 2-30.

**15** Click **OK**. The Send Receive block dialog box dialog box closes.

Your next task is to build and run the target application.

## Building and Running the Target Application (Composite)

xPC Target and Real-Time Workshop® create C code from your Simulink model. You can then use a C compiler to create executable code that runs on the target PC.

After you have added the RS-232 blocks for the main board to your Simulink model, you can build your target application.

---

**Note** You cannot use a serial port to communicate between the host PC and target PC with this example. You can only use COM1 if it is not already in use for host-target communications. Additionally, if COM1 and COM3 share an interrupt, you cannot use COM3 if COM1 is already in use for host-target communications.

---

**1** In the Simulink window, and from the **Tools** menu, point to **Real-Time Workshop**, and then click **Build Model**.

- 2 In the MATLAB Command Window, type  
`+tg` or `tg.start` or `start(tg)`

### **RS-232/422/485 Simulink Block Reference**

xPC Target supports RS-232/422/485 communication with driver blocks in your Simulink model.

This section includes the following topics:

- “Signal Data Types” on page 2-12 — Describes signal data types that composite drivers support.
- “ASCII Encode/Decode” on page 2-16 — (Generic) Describes encoder and decoder blocks. Encoders convert input signals for the send/receive subsystem to ASCII strings. ASCII decoders parse the string from the Send/Receive subsystem.
- “FIFO Read/Write” on page 2-19 — (Generic) Describes FIFO read and write blocks.
- “RS232 State” on page 2-29 — (Generic) Monitors the hardware error state information that is present in the output vector from all blocks.
- “Send/Receive Blocks” on page 2-30 — Provides blocks for sending and receiving.
- “Modem Control” on page 2-44 — Controls the state of either or both of the RTS and DTR output lines.
- “Modem Status” on page 2-47 — Reads the states of the four input modem control lines.
- “RS-232/422/485 Internal Blocks and Subsystems” on page 2-49 — Provides blocks to customize the RS-232/422/485 drivers.

#### **Signal Data Types**

Signals between blocks in composite drivers can be one of several basic data types, 8-bit and 16- or 32-bit. Both of these types are structures.

8-bit data types are NULL-terminated strings that are represented as Simulink vectors. The width is the maximum number of characters that can be stored. In the following figure, M is the actual set of stored characters and N is the maximum number of characters that can be stored.

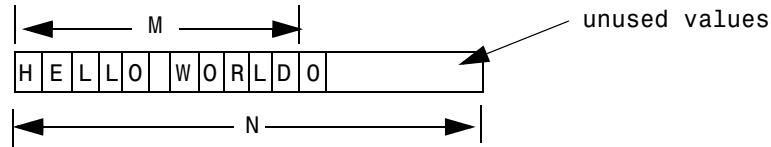

This string has 11 characters terminated with a NULL byte (0). This data type cannot contain a NULL byte as part of the real data.

16- and 32-bit data types use the first element of the vector as a count of the valid data. In the following figure of a 16-bit data type, C is the count of the valid data, N is the width of the vector.

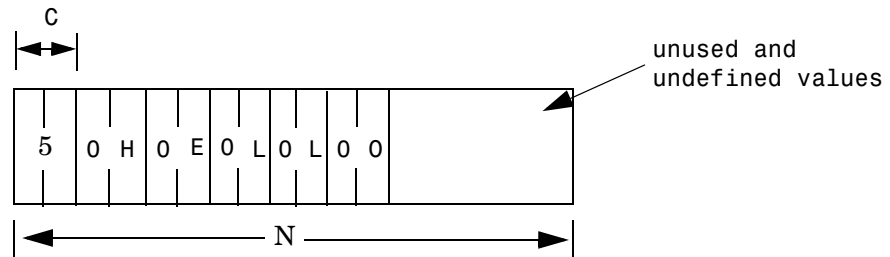

These serial blocks interpret each entry in the vector as a single character. The low-level hardware Send block writes the low-order byte of each entry to the UART. The 16- and 32-bit data types allow the embedding of any 8-bit data value, including 0.

The 8-bit data type is most useful with the ASCII Encode and Decode blocks. The 16- and 32-bit data types are most useful for binary data streams.

### Defining the Commtech Fastcom Baud Rate

The Commtech Fastcom 422/2-PCI board can handle baud rates up to 1.5 megabaud. To configure a baud rate for the board, you need to set the following parameters:

- **Clock Bits** in the Fastcom 422/2-PCI Send Receive block with the **Parameter group** parameter set to Board Setup

- **Baud Divisor** in the Fastcom 422/2-PCI Send Receive block with the **Parameter group** parameter set to **Basic Setup**

The Fastcom 422/2-PCI board has two serial channels, each of which has an independent counter (baud clock). A master clock generator, which has a phase locked loop, controls the master clock for both serial channels. The master clock generates a maximum baud rate for both channels. The block determines the actual baud rate of a channel by dividing the maximum baud rate from the master clock by the baud rate divisor ( $n$ ).

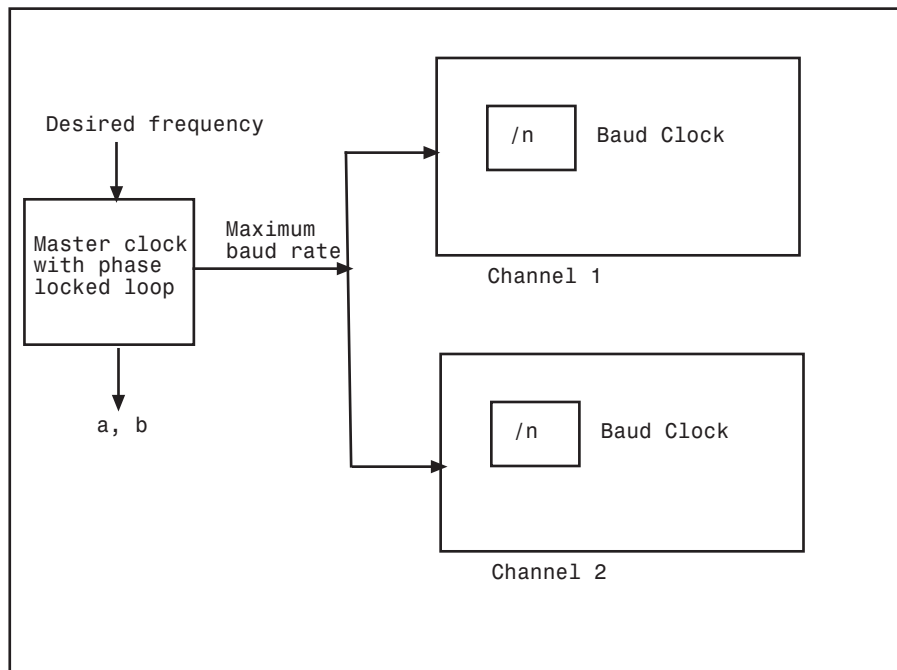

Fastcom 422-2 PCI Board

To correctly set the block parameters for this board, choose a maximum baud rate, as follows. This procedure assumes that both channels require different baud rates. Determine a common base clock that can be divided to produce the required baud rates for both channels, as follows:

- 1 In the MATLAB command window, type a command like the following. With a desired frequency (for example,  $1.5e6$ ) as the desired input, the `fc422mexcalcbits` utility calculates parameter values that you can use to configure the board rate for your board.

```
[a b df ] = fc422mexcalcbits(1.5e6)
```

This command returns three values.

```
a = 12199144
```

```
b = 24
```

```
df = 1500000
```

- 2 Examine the `df` value. The `df` value is the actual frequency the board will be able to attain compared to your desired frequency. If the actual attainable frequency is not accurate enough, you might want to try another frequency. In this example, the board can match the desired frequency of 1500000 ( $1.5e6$ ).
- 3 Enter the first two values in the **Clock Bits** parameter of the Fastcomm 422/2-PCI Send Receive block with the **Parameter group** parameter set to Board Setup.

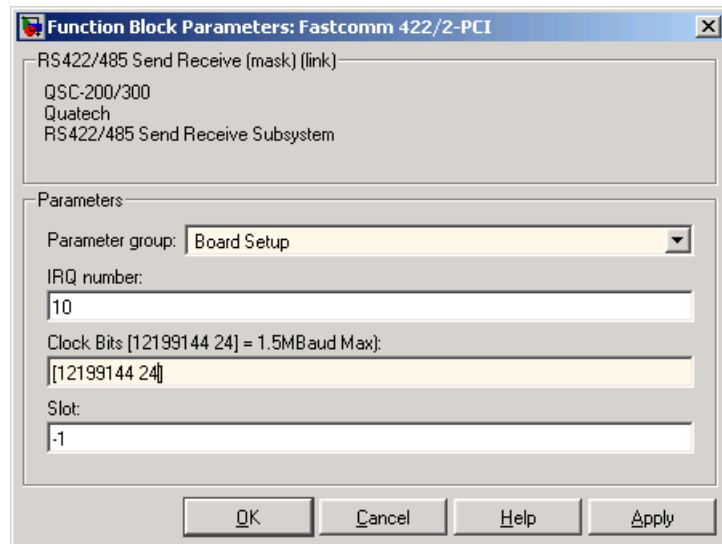

After you define a maximum baud rate, you can set a unique baud rate for each channel by choosing a different baud rate divisor for each channel. For example, you can have Channel 1 have a baud rate of 750000 (1500000/2) and Channel 2 have a baud rate of 1500000 (1500000/1). To set Channel 1 to have a baud rate of 750000, with the Fastcom 422/2-PCI Send Receive block with the **Parameter group** parameter set to **Basic Setup**, set

- **Port to modify** to 1
- **Baud Divisor** to 2

---

**Note** For very slow baud rates (less than 30000), you must use the **Baud Divisor** parameter to achieve the desired baud rate.

---

### ASCII Encode/Decode

The ASCII Encode block generates a UINT8 output vector that contains a NULL-terminated string based on a printf like format string and data on the input ports. The dialog box for the RS-232 ASCII Encode block contains the following fields:

Parameter	Description
<b>Format string</b>	Enter a printf like format string. Each format specifier such as %d is replaced by the converted value that is present on the corresponding input variable. Acceptable format specifiers are %c, %d, %i, %o, %u, %x, %e, %f, and %g. These follow the normal description for printf.
<b>Number of variables</b>	Enter the number of input ports to this block. The value on each port is inserted into the output string with the format specified in <b>Format string</b> .



Parameter	Description
<b>Max output string length</b>	<p>Enter the maximum allowed length of the converted string, in bytes. The block allocates enough memory to support this length for the output port. When selecting this length, take into account the NULL termination on the string.</p> <p>If the converted string exceeds this length, the block returns an error and does not write that string to the output port.</p>
<b>Variable types</b>	<p>Enter one of the following: {'double'}, {'int8'}, {'uint8'}, {'int16'}, {'uint16'}, {'int32'}, and {'uint32'}. The default is {'double'}. This parameter specifies the Simulink data types allowed for the input ports. A cell vector with the same number of elements as specified in <b>Number of variables</b> can specify a different data type for each input port. A single element is replicated. For example,</p> <p>nvars=3</p> <p>{ } — All three inputs are doubles.</p> <p>{ 'uint8' } — All three inputs are uint8.</p> <p>{ 'uint16', 'double', 'uint8' } — There are three inputs: the first is a uint16, the second is a double, and the third is a uint8.</p>

The ASCII Decode block parses an input vector according to a format specifier similar to `scanf`, and makes converted values available to a Simulink program. The input vector to the ASCII Decode block can be either 8-bit or 16-bit and signed or unsigned. If the data format is 16-bit, the ASCII Decode block ignores

the upper eight bits of each entry. The dialog box for the RS-232 ASCII Decode block contains the following fields:

<b>Parameter</b>	<b>Description</b>
<b>Format string</b>	Enter a scanf like format string. Each format specifier such as %d needs to match a corresponding part of the input vector. Literal strings in the format need to match the first character plus the number of characters. Acceptable format specifiers are %c, %d, %i, %o, %u, %x, %e, %f, and %g. These follow the normal description for scanf.
<b>Number of variables</b>	Enter the number of output ports for this block. For example,  If <b>Format string</b> has the value of %xmore text%x and the input vector for the block has cdmabcdefgh90, you must specify the value of the <b>Number of variables</b> parameter as 2.  The first variable is assigned the value 0xcd. Next, the string mabcdefgh is considered a match to more text because <ul style="list-style-type: none"><li>• The first character for both strings is m.</li><li>• Both strings have the same number of characters.</li></ul>

Parameter	Description
	<p>The second variable is then assigned the value 0x90. Note that the string mabcdefgh does not have to match exactly the value of <b>Format string</b>. This behavior is different from that for <code>scanf</code>, which requires an exact match.</p>
<b>Variable types</b>	<p>Enter one of the following: {'double'}, {'int8'}, {'uint8'}, {'int16'}, {'uint16'}, {'int32'}, and {'uint32'}. The default is {'double'}. This parameter specifies the Simulink data types allowed for the output ports. A cell vector with the same number of elements as specified in <b>Number of variables</b> can specify a different data type for each output port. A single element is replicated. For example,</p> <p>nvars=3</p> <p>{ } — All three outputs are doubles.</p> <p>{'uint8'} — All three outputs are uint8.</p> <p>{'uint16', 'double', 'uint8'} — There are three outputs: the first is a uint16, the second is a double, and the third is a uint8.</p>

## FIFO Read/Write

This section describes the FIFO Read and Write blocks. Of particular note are the FIFO Read blocks, of which there three. Use the following guidelines when using these blocks:

- **Simple data streams** — Use the FIFO Read block to read simple data streams. An example of a simple data stream is one that has numbers, separated by spaces, and that is terminated by a newline. The FIFO Read block is a simple block that can easily extract these numbers.
- **More complicated data streams** — Use the FIFO Read HDRS and FIFO Binary blocks for more complicated data streams. A more complicated data stream can be one that contains headers, messages of varying lengths, or

messages with no specific terminators. A message header consists of one or more character identifiers at the beginning of a message that specify what data follows. ASCII messages normally have a variable length and a terminator. Typically, all messages of a particular device use the same predefined terminator. Binary messages are normally of fixed length with no specific terminator.

The FIFO Read HDRS or FIFO Binary blocks are also useful to work with devices that can send different messages at different times.

All three FIFO read block types need their input to be of type `serialfifoptr`, which is output from F type Send Receive subsystems.

The following are examples of when can use the FIFO read blocks.

- For an instrument that sends a string like the form

`<number> <number> ... <CR><LF>`

use the simple FIFO Read block to read the message. Configure the FIFO Read block **Delimiter** parameter for a line feed (value of 10).

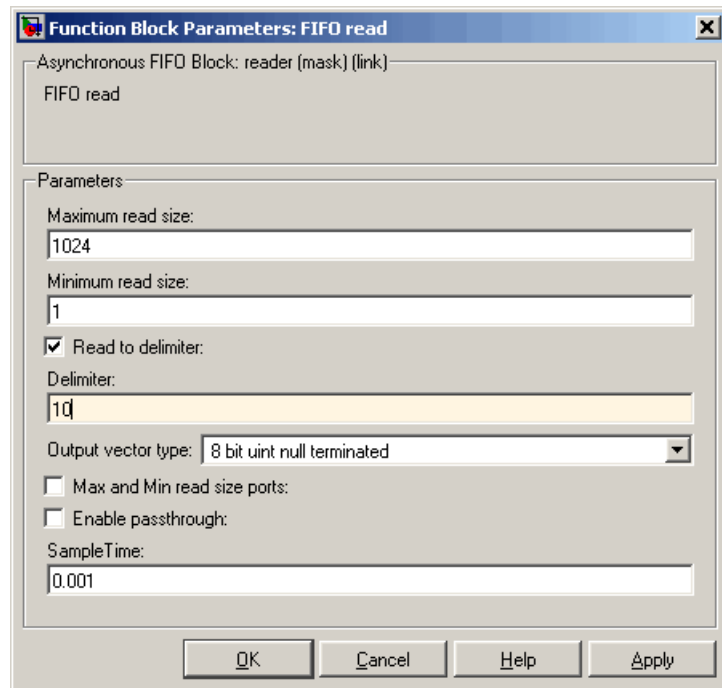

You should then connect the output to an ASCII Decode block with a format that separates the numbers and feeds them to the output ports.

- For an instrument that can send one of a number of different messages, and each message begins with a different fixed string, use the FIFO Read HDRS block. For example, a digital multimeter connected through an RS-232 port, might send a voltage reading and an amp reading with messages of the following format:

```
volts <number> <CR><LF>
amps <number> <CR><LF>
```

Configure the FIFO Read HDRs block **Header** parameter for the volts and amps headers, in a cell array. Also configure the **Terminating string** parameter for carriage return (value of 13) and line feed (value of 10).

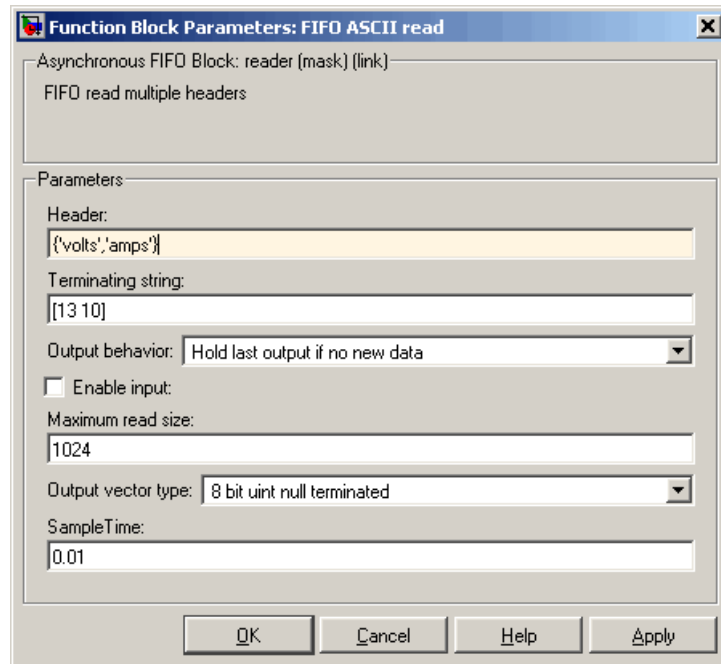

You should then connect the output to multiple ASCII Decode blocks, one for each header and message. See the `xpcserialasciitest` and `xpcserialasciisplit` models in `xpcdemos` for examples of how to use this block in a model.

- For an instrument that sends a binary message, you typically know the length of each full message, including the header. Configure the FIFO Read Binary block **Header** parameter for the headers of the message, in a cell array, and the **Message Lengths** parameter for the message lengths. See the `xpcserialbinarytest` and `xpcserialbinarysplit` models in `xpcdemos` for further examples of how to use this block in a model.

**FIFO Read/Write.** The FIFO Read block is the read side of a FIFO read/write pair. There are two modes for this block:

- If **Read to delimiter** is checked, this block only reads elements if the chosen delimiter is found in the FIFO. If the delimiter has not yet been written to the write side of this FIFO, the block returns a zero length vector, as

determined by the data type. If the delimiter is found, the block returns elements up to and including the delimiter in the output vector. Selecting this check box cause the block to perform ASCII reads.

- If **Read to delimiter** is not checked, this block returns a number of elements between **Minimum read size** and the smaller of the number of elements currently in the FIFO and **Maximum read size**. Selecting this check box cause the block to perform binary reads.

The dialog box for the RS-232 FIFO Read block contains the following fields:

Parameter	Description
<b>Maximum read size</b>	Enter the largest desired read size in bytes. This parameter specifies the width of the output vector and the maximum number of elements to return. See <b>Output vector type</b> for more information about data formats. This value is always the absolute maximum read size, whether or not the <b>Max and Min read size ports</b> check box is selected.
<b>Minimum read size</b>	Enter the smallest desired read size in bytes. The FIFO must contain at least this number of elements before any elements will be returned. If you select the <b>Max and Min read size ports</b> check box, this value is superseded by the external signals.
<b>Read to delimiter</b>	Select this check box to enable the return of element sets that terminate with the <b>Delimiter</b> value. Use this parameter when working with character-based elements.
<b>Delimiter</b>	Enter the decimal value for an 8-bit input terminator. This parameter specifies the value on which a FIFO read operation should terminate. It works with the <b>Read to delimiter</b> parameter. By default, this block looks for a carriage return. It only returns characters when one is found. For reference, the decimal value of a carriage return is 13, a line feed is 10.

Parameter	Description
<b>Output vector type</b>	From the list, select count+32 bit int, count+32 bit uint, count+16 bit int, count+16 bit uint, 8 bit int null terminated, or 8 bit uint null terminated. This parameter specifies the output vector type. The 8-bit data types produce a null terminated string in the output vector. For 16- and 32-bit data types, the first element contains the number of elements to expect in the rest of the output vector.
<b>Max and Min read size ports</b>	<p>Select this check box to enable the maximum and minimum input ports. When this check box is selected,</p> <ul style="list-style-type: none"> <li>• The value from the maximum input port is the maximum number of characters to be removed from the FIFO. Note that if this number exceeds the value of <b>Maximum read size</b>, the block disregards the value from the maximum input port and takes the value of <b>Maximum read size</b> as the maximum number of characters to be removed from the FIFO.</li> <li>• The value from the minimum input is the minimum number of characters the FIFO must contain before any elements can be returned. This value supersedes the value set with the <b>Minimum read size</b> parameter.</li> </ul>
<b>Enable passthrough</b>	Select this check box to pass the maximum read input through to the passthrough output.
<b>SampleTime</b>	Base sample time or a multiple of the base sample time.



The following are some examples of how you can set up the FIFO Read block:

- In the transmit side of the interrupt service routine, the maximum input port receives a value of 0 if the interrupt reason is not an empty hardware FIFO, and the hardware FIFO size if the hardware FIFO is empty. The minimum input port receives the constant value of 1.  
On the receive side, the typical case with ASCII data has the minimum and maximum input ports disabled. The **Read to delimiter parameter** check box is selected and the **Delimiter** parameter has the value of carriage return or line feed. The value of the **Maximum read size** parameter is large (along the order of the FIFO size) and the value of **Minimum read size** parameter is 1. In this form, the driver acts like a nonblocking read line.
- An alternate receive-side configuration for fixed-length binary blocks of data has the value of the **Maximum read size** and **Minimum read size** parameters set to the fixed length of the block. The **Read to delimiter** parameter is not selected.

The FIFO Write block is the write side of a FIFO read/write pair. The dialog box for the RS-232 FIFO Write block contains the following fields:

Parameter	Description
<b>Size</b>	Enter the number of elements that can be held in the FIFO at any one time. If a write operation to the FIFO causes the number of elements to exceed <b>Size</b> , an error occurs.
<b>Input vector type</b>	From the list, select count+32 bit int, count+32 bit uint, count+16 bit int, count+16 bit uint, 8 bit int null terminated, or 8 bit uint null terminated. This parameter specifies the input vector type. The 8-bit data types need a null terminated string in the output vector. For 16- and 32-bit data types, the first element contains the number of elements to expect in the rest of the input vector.

<b>Parameter</b>	<b>Description</b>
<b>Data present output</b>	Select this check box to create a Boolean output that is true if data is present in the FIFO. The transmit side of the send/receive subsystem uses this output. This output is given to the Enable TX block, which enables the transmitter buffer empty interrupt.
<b>SampleTime</b>	Base sample time or a multiple of the base sample time.
<b>ID</b>	Enter a user-defined identifier for overflow messages.

**FIFO Read HDRS.** The FIFO Read HDRS block identifies and separates ASCII data streams that have embedded identifiers. The data following a particular header might have varying lengths, but all have a common termination marker such as <CR><LF>. While you can attain this same functionality with the sample FIFO Read block, doing so requires a complicated state machine.

The `xpcdemos` directory contains the following demos that illustrate how to use the FIFO Read HDRS block: `xpcserialasciitest` and `xpcserialasciisplit`.

The dialog box for the RS-232 FIFO Read HDRS block contains the following fields:

<b>Parameter</b>	<b>Description</b>
<b>Header</b>	Enter the headers that you want the block to look for in a block of data from the FIFO. Enter each header as an element in a cell array.
<b>Terminating string</b>	Enter the terminating string for the data. Enter as many characters as needed to define the end of string. This is typically one or two characters.

<b>Parameter</b>	<b>Description</b>
<b>Output behavior</b>	From the list, select the behavior of the block if the FIFO has no new data. Select <b>Zero output if no new data</b> if you want the block to have no output if there is no new data. Select <b>Hold last output if no new data</b> if you want the block to keep the output from the last FIFO message.
<b>Enable input</b>	Select this check box to turn on a new input that takes Boolean signals that enable or disable the read.
<b>Maximum read size</b>	Enter the largest desired read size in bytes. This parameter specifies the width of the output vector and the maximum number of elements to return. See <b>Output vector type</b> for more information about data formats.
<b>Output vector type</b>	From the list, select count+32 bit int, count+32 bit uint, count+16 bit int, count+16 bit uint, 8 bit int null terminated, or 8 bit uint null terminated. This parameter specifies the output vector type. The 8-bit data types produce a null terminated string in the output vector. For 16- and 32-bit data types, the first element contains the number of elements to expect in the rest of the output vector.
<b>SampleTime</b>	Base sample time or a multiple of the base sample time.

**FIFO Read Binary.** The FIFO Read Binary block reads multiple binary headers from a FIFO. This block identifies and separates data by finding unique byte sequences (headers) that mark the data. Each header indicates the start of a fixed length binary message.

The `xpcdemos` directory contains the following demos that illustrate how to use the FIFO Read HDRS block: `xpcserialbinarytest` and `xpcserialbinarysplit`.

<b>Parameter</b>	<b>Description</b>
<b>Header</b>	Enter the headers that you want the block to look for in a block of data from the FIFO. Enter each header as an element in a cell array either as a quoted string or a concatenation with <code>char(val)</code> for non-printable byte patterns.
<b>Message Lengths</b>	Enter the message length of each byte of data as bytes of data. Include the header in the length.
<b>Output behavior</b>	From the list, select the behavior of the block if the FIFO has no new data. Select <b>Zero output if no new data</b> if you want the block to have no output if there is no new data. Select <b>Hold last output if no new data</b> if you want the block to keep the output from the last FIFO message.
<b>Enable input</b>	This check box enables or disables a FIFO read. Select this check box to turn on a new input that takes Boolean signals that enable or disable the read.
<b>Maximum read size</b>	Enter the largest desired read size in bytes. This parameter specifies the width of the output vector and the maximum number of elements to return. See <b>Output vector type</b> for more information about data formats.

Parameter	Description
<b>Output vector type</b>	From the list, select count+32 bit int, count+32 bit uint, count+16 bit int, count+16 bit uint, 8 bit int null terminated, or 8 bit uint null terminated. This parameter specifies the output vector type. The 8-bit data types produce a null terminated string in the output vector. For 16- and 32-bit data types, the first element contains the number of elements to expect in the rest of the output vector.
<b>SampleTime</b>	Base sample time or a multiple of the base sample time.

### RS232 State

The RS232 State block monitors the board state information that is present in the vector coming out of a receive port on a send/receive block.

The input data vector can be one of Int8, UInt8, Int16, or UInt16. If the input vector is Int8 or UInt8, no error status is available and the Boolean outputs are always false. If the input vector is Int16 or UInt16, the upper byte should contain the error status bits from the UART.

This block accumulates errors over the whole input vector. An output error state is true if it is true for any byte in the input vector.

The FIFO Hardware FIFO block puts the UART status in 16+32 bit data streams. The RS232 State block looks at this status. Note that only the FIFO Read block passes this status information to its output port.

The dialog box for the RS-232 State block contains the following fields:

<b>Parameter</b>	<b>Description</b>
<b>Overrun error output</b>	Select this check box to retrieve overrun error output. This output is true if the hardware FIFO in the UART was filled at any time while a character in the input vector was being received.
<b>Parity error output</b>	Select this check box to retrieve parity error output. This output is true if any byte in the input vector has incorrect parity.
<b>Framing error output</b>	Select this check box to retrieve framing error output. This output is true if a framing error occurs on any character in this vector. For example, a framing error might occur if the baud rates between the transmitter and receiver do not match.
<b>Break interrupt output</b>	Select this check box to retrieve break interrupt output. A break interrupt output is not an error, but the UART treats it like an error state. The break condition is detected if the serial line remains at logic 0 (negative voltage) for more than one character time.

---

**Note** Disconnecting the serial cable does not cause a break with some serial port hardware.

---

### Send/Receive Blocks

The dynamic dialog for these subsystem blocks allows you to perform basic board setup and setup of send/receive data. You control parameter visibility with the **Parameter Group** parameter and the port number.

There are two versions of this block, non-F and F (FIFO). All serial boards plus the main board have these two versions. The primary difference is that the F blocks bring the FIFO signal out of the subsystem. For example

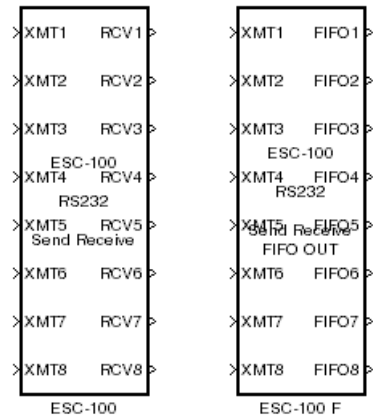

- The non-F blocks have RCV outputs. These blocks have basic FIFO read blocks inside the subsystem. These blocks are most useful for simple character streams. These subsystem blocks generate output as an array of packed integers (settable at 8, 16, or 32 bits) with characters in the lower byte and received status information in the upper byte.
- The F blocks have FIFO outputs. These blocks give you greater flexibility and allow you to use any one of the FIFO read blocks.
  - FIFO Read block — A model that contains an F block in combination with the FIFO Read block provides the same capability as the non-F block.
  - FIFO Read HDRS and FIFO Read Binary — A model that contains an F block in combination with a FIFO Read HDRS or FIFO Read Binary block provides greater capability than the FIFO Read block. (See “FIFO Read HDRS” on page 2-26 and “FIFO Read Binary” on page 2-27 for details.)

Only one Send/Receive block can exist for each interrupt. All ports that use that interrupt must be associated with that block.

For example, if you have four ports configured on the mainboard, COM1 and COM3 typically share an interrupt. In this case, COM1 and COM3 must then share the same Send/Receive block. COM1 is of note because you can use it for host PC/target PC communication. If COM1 is the host PC/target PC link, neither COM1 nor COM3 can be used with this block as long as they share an interrupt. The same is true for COM2 and COM4.

Each F Send Receive has Board Setup and Basic Setup configuration parameter options that are the same as their non-F Send Receive block counterparts. To provide direct access to the board, these blocks also have a FIFO Setup parameter option. The following descriptions do not distinguish between the F and non-F blocks unless necessary.

The **Parameter Group** parameter allows you to choose which subset of configuration parameters you want to modify.

**Parameter Group** — From the list, choose Board Setup, Basic Setup, Transmit Setup, or Receive Setup. The visible set of parameters changes according to your selection. The following screenshots reflect the Send Receive block for the Quatech ESC-100.

Parameter Group: Board Setup

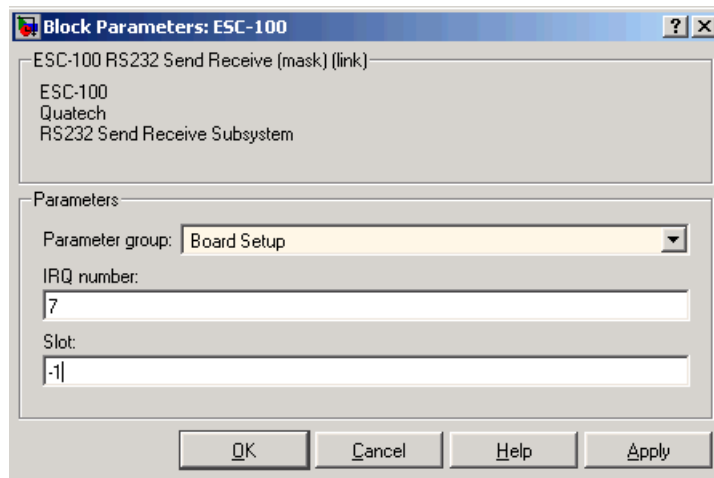



Parameters	Description
<b>Configuration</b> (Mainboard)	<p>From the list, choose combinations of port pairs (Com1 / none, Com2 / none, Com1 / Com3, Com2 / Com4, none / Com3, none / Com4, or Custom). This parameter specifies the ports for which you are defining transmit and receive. A Custom port is one that does not match the existing combinations of port pairs. For example, you can set the IRQ and two addresses or, if one of the ports is not used, set that to 0.</p>
<b>IRQ number</b> (Quatech, Commtech)	<p>Enter the number of the interrupt request line for this board. If you do not know the interrupt request line number for this board, at the MATLAB Command Window, enter</p> <pre>getxpcpci</pre> <p>This command displays all the PCI interfaces currently attached to the target PC. From that display, find the instance of the board controlled by this block. Each board uses a unique interrupt request line number.</p> <p>For Emerald-MM, set this to the IRQ chosen by jumpers on the board. Set all four ports to the same IRQ.</p> <p>For Emerald-MM-8, this block setting programs the board IRQ.</p> <p>(Diamond) Not all IRQ values work in all target PC machines. You should experiment to find a working combination.</p>
<b>Clock Bits</b> (Commtech)	<p>Enter the number of clock bits to control a clock generator common to both channels. This parameter adjusts the master clock of both channels.</p>

<b>Parameters</b>	<b>Description</b>
<b>Slot</b> (PCI boards)	<p>If only one board of this type is physically present in the target PC, enter</p> <p>- 1</p> <p>to automatically locate the board.</p> <p>If two or more boards of this type are physically present in the target PC, enter the bus number and the PCI slot number of the board associated with this driver block. Use the format [BusNumber , SlotNumber]. To determine the bus number and the PCI slot number, type</p> <pre>getxpcpci</pre>

Parameters	Description
<b>Base address</b> (Diamond Emerald-MM-8)	<p>Enter the base address of the board that you are setting up. This is the address of the configuration register on the board. The first port address referenced in Modem Control and Modem Status blocks is offset 0x10 from the configuration register address, and each subsequent port address is offset 0x8 from that.</p> <p>You must set the configuration register address on the board with a jumper. You can set the configuration register address to one of the following addresses: 0x100, 0x140, 0x180, 0x1c0, 0x200, 0x240, 0x280, 0x2c0, 0x300, 0x340, 0x380, or 0x3c0. Note that xPC Target assigns successive 8 byte addresses to the eight UARTs even though the hardware allows random placement.</p> <p>Be sure that these addresses do not conflict with the COM port addresses listed in “Adding RS-232 Blocks” on page 2-6. Note that if you set the configuration register address to 0x2c0, it conflicts with COM2. If you set the configuration address to 0x3c0, it conflicts with COM1.</p>
<b>First port address</b> (Diamond Emerald-MM)	<p>From the list, select the first port address for the board. This address is the first of four port addresses for the Emerald-MM board. You must initially set this address on the board with a jumper. The remaining three addresses follow consecutively in increments of 0x8. Be sure that these addresses do not conflict with the COM port addresses listed in “Adding RS-232 Blocks” on page 2-6.</p>

Parameter Group: Basic Setup

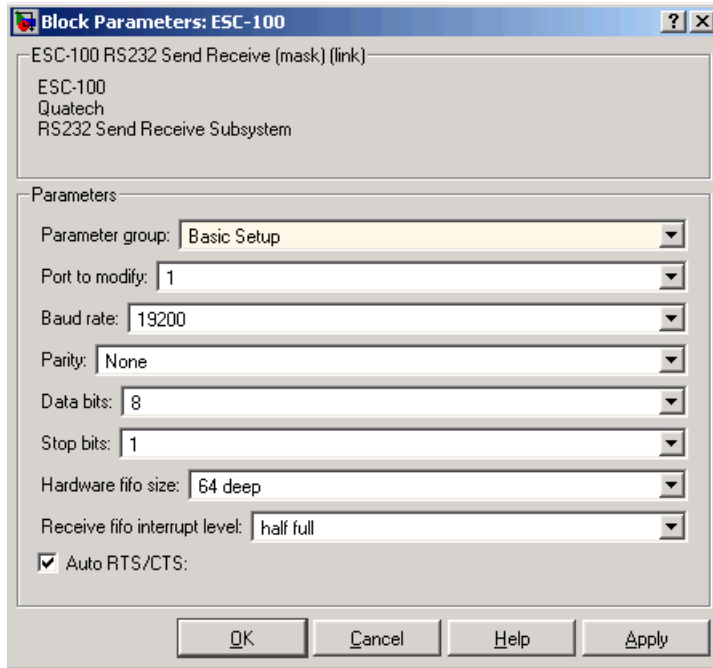

<b>Parameters</b>	<b>Description</b>
<b>Port to modify</b>	<p>From the list, choose a port. The <b>Port to modify</b> parameter specifies the port for which you want to view or modify the parameters.</p> <p>For Baseboard drivers, the port is the Simulink block port, where the upper port is 1 and the lower port is 2. For all other drivers, the port number corresponds to the channel number.</p>
<b>Baud Divisor</b> (Commtech)	Enter a divisor integer. The block determines the actual baud rate for a particular channel by dividing the maximum baud rate by this divisor. This number can be different for each channel.
<b>Baud rate</b> (Mainboard, Quatech, Diamond)	From the list, choose a baud rate.
<b>Parity</b>	From the list, choose None, Even, Odd, Mark, or Space. This parameter defines the parity.
<b>Data bits</b>	From the list, choose either 5, 6, 7, or 8 to select the number of bits per character.
<b>Stop bits</b>	From the list, choose either 1 or 2 to define the number of stop bits for the port. Most modern hardware works fine with a character stream that uses single (1) stop bits.

Parameters	Description
<p><b>Hardware FIFO size</b> (Quatech, Diamond)</p>	<p>From the list, choose either 64 deep, 16 deep, or 1 deep. This parameter specifies the size of the FIFO in the UART. The <b>Hardware FIFO size</b> parameter affects both the receive and transmit FIFOs. For example, specifying a FIFO size of 64 bytes results in fewer interrupts. Fewer interrupts can allow more processing to occur in the model.</p> <p>The types of UARTs include</p> <p>16450 — Maximum 1 byte depth</p> <p>16550 — Maximum 16 byte FIFO depth</p> <p>16750 — Maximum 64 byte FIFO depth</p>
<p><b>Receive FIFO interrupt level</b></p>	<p>From the list, choose 1, quarter full, half full, or almost full. This parameter specifies the number of characters in the Receive FIFO before an interrupt occurs. Receive interrupts occur at least as often as this parameter specifies.</p> <p>If a gap of at least 4 character times, the span of four characters, occurs in a data stream, the UART requests an interrupt for the receiver. The UART requests an interrupt regardless of the value of <b>Receive FIFO interrupt level</b>. If there is at least one character in the hardware FIFO, an interrupt is signaled.</p> <p>(Commtech) The Fastcom 422/2-PCI hardware FIFO is fixed at 128 bytes for receive and transmit. By default, this parameter is set to 64. In general, leave this value at 64. If receive latency is critical, you might want to reduce this value to the size of your receive data packet.</p>

Parameters	Description
<b>Auto RTS/CTS</b> (RS-232 boards)	<p>Select this check box to enable the hardware-based handshake for flow control. This RTS/CTS handshake feature of the UART provides a reliable way to prevent loss due to hardware FIFO overflow.</p> <p>Because of the large 64 byte FIFO in the hardware, flow control that is based on software control in the interrupt service routine can have problems. In most cases, the interrupt service routine executes quickly enough to empty the hardware FIFO. However, if you get hardware FIFO overruns, select this check box. Doing so causes the hardware to stop sending data.</p>
<b>Assert on transmit</b> (RS-422/485 boards)	From the list, select None, RTS, or DTR to specify the state of the RTS or DTR line. The block asserts the selected line upon transmission.

Parameter Group: Transmit Setup

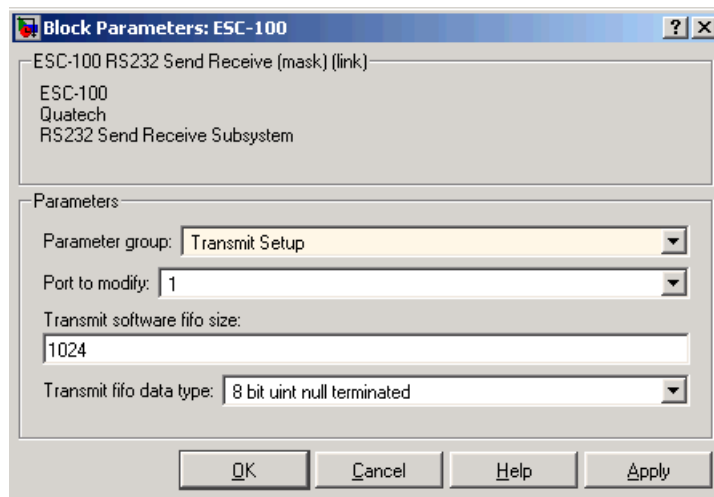

(Non-F Send Receive blocks)

<b>Parameters</b>	<b>Description</b>
<b>Port to modify</b>	From the list, choose a port. The <b>Port to modify</b> parameter specifies the port for which you want to view or modify the parameters.
<b>Transmit software FIFO size</b>	Enter the transmit software FIFO size, in bytes. This parameter specifies the size of the software FIFO used to buffer transmitted characters.
<b>Transmit FIFO data type</b>	<p>From the list, choose count+32 bit int, count+32 bit uint, count+16 bit int, count+16 bit uint, 8 bit int null terminated, or 8 bit uint null terminated. This parameter specifies the data type of the transmitter. The 8-bit data types require a NULL-terminated string in the input vector.</p> <p>The 16- and 32-bit data types reserve the first full element to contain the number of elements to expect in the rest of the input vector. Only the low-order byte of each data element is sent. Setting this data type allows a wider data type to hold the bytes. If the data stream needs to include a NULL byte, you must select one of the 16- or 32-bit data types.</p>



## Parameter Group: Receive Setup

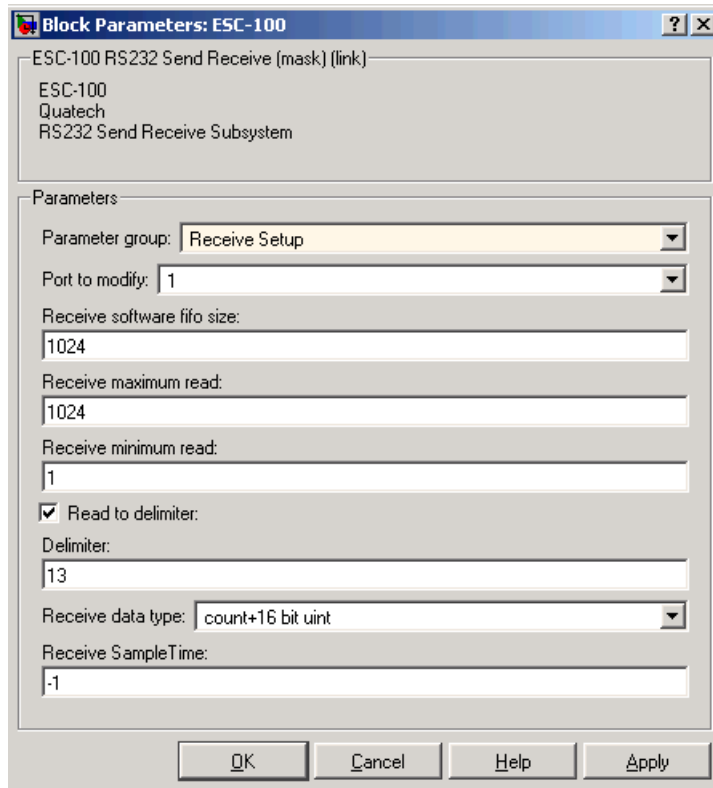

The screenshot shows a Windows-style dialog box titled "Block Parameters: ESC-100". The dialog is divided into two main sections. The top section, titled "ESC-100 RS232 Send Receive (mask) (link)", contains the text "ESC-100", "Quatech", and "RS232 Send Receive Subsystem". The bottom section, titled "Parameters", contains several configuration fields:

- "Parameter group:" is a dropdown menu set to "Receive Setup".
- "Port to modify:" is a dropdown menu set to "1".
- "Receive software fifo size:" is a text input field containing "1024".
- "Receive maximum read:" is a text input field containing "1024".
- "Receive minimum read:" is a text input field containing "1".
- "Read to delimiter:" is a checked checkbox.
- "Delimiter:" is a text input field containing "13".
- "Receive data type:" is a dropdown menu set to "count+16 bit uint".
- "Receive SampleTime:" is a text input field containing "-1".

At the bottom of the dialog are four buttons: "OK", "Cancel", "Help", and "Apply".

(Non-F Send Receive blocks)

<b>Parameters</b>	<b>Description</b>
<b>Port to modify</b>	From the list, choose a port. The <b>Port to modify</b> parameter specifies the port for which you want to view or modify the parameters.
<b>Receive software FIFO size</b>	Enter the size of the receive software FIFO, in bytes. This parameter specifies the size of the software FIFO to buffer characters between interrupt service and periodic execution.
<b>Receive maximum read</b>	Enter the maximum number of elements that you want returned by a single call to this block. This parameter is also used to set the output vector width. If the <b>Read to delimiter</b> check box is selected, the maximum number of characters read is limited by this parameter even if the delimiter is not found.
<b>Receive minimum read</b>	Enter the minimum number of characters to read. If the FIFO does not contain at least this number of characters, the output vector is empty.
<b>Read to delimiter</b>	<p>Select this check box to have this block return all characters in the FIFO up to and including the specified delimiter. If the block does not find the delimiter in the FIFO, it returns no characters.</p> <p>Note that if the buffer has hardware observed errors, such as framing errors, characters are returned regardless of the presence of the delimiter. This special case helps diagnose errors such as mismatched baud rates.</p>
<b>Delimiter</b>	Enter the numeric value of the character that is the message delimiter. Any value from 0 to 255 is valid. The common case looks for 10 (line feed) or 13 (carriage return).

<b>Parameters</b>	<b>Description</b>
<b>Receive data type</b>	<p>From the list, select count+32 bit int, count+32 bit uint, count+16 bit int, count+16 bit uint, 8 bit int null terminated, or 8 bit uint null terminated. This parameter specifies the data type of the receiver. The 8-bit data types produce a null terminated string in the output vector. For 16- and 32-bit data types, the first element contains the number of valid elements in the rest of the output vector.</p> <p>For 8-bit data types, only the character data is in the output vector, and a NULL terminator is appended. The 16- or 32-bit wide data types cause the error status from the UART to be placed in the second byte of each data element. (The error status contains the parity, overrun, framing, and break bits.) The character data is in the bottom eight bits of each element; the first element of the vector contains the number of data elements that follow.</p>
<b>Receive SampleTime</b>	Base sample time or a multiple of the base sample time.

Parameter Group: FIFO Setup

(All F Send Receive blocks)

<b>Parameters</b>	<b>Description</b>
<b>Port to modify</b>	From the list, choose port 1 or 2. The <b>Port to modify</b> parameter specifies the port for which you want to view or modify the parameters.
<b>Transmit software FIFO size</b>	Enter the transmit software FIFO size, in bytes. This parameter specifies the size of the software FIFO used to buffer transmitted characters.

<b>Parameters</b>	<b>Description</b>
<b>Transmit FIFO data type</b>	<p>From the list, choose count+32 bit int, count+32 bit uint, count+16 bit int, count+16 bit uint, 8 bit int null terminated, or 8 bit uint null terminated. This parameter specifies the data type of the transmitter. The 8-bit data types require a NULL-terminated string in the input vector.</p> <p>The 16- and 32-bit data types reserve the first full element to contain the number of elements to expect in the rest of the input vector. Only the low-order byte of each data element is sent. Setting this data type allows a wider data type to hold the bytes. If the data stream needs to include a NULL byte, you must select one of the 16- or 32-bit data types.</p>
<b>Receive software FIFO size</b>	<p>Enter the size of the receive software FIFO, in bytes. This parameter specifies the size of the software FIFO to buffer characters between interrupt service and periodic execution.</p>

### **Modem Control**

The Modem Control block controls the state of either or both of the RTS and DTR output lines on the specified port.

This block requires an input of type `double`. If the input value is greater than 0.5, the block asserts the RTS or DTR control bit to true and the output goes to a positive voltage. If the value is less than or equal to 0.5, the block asserts the RTS or DTR control bit to false and the output goes to a negative voltage. If RTS or DTR is not selected, the corresponding output is not changed.

The dialog box for the Modem Control block contains the following fields:

<b>Parameter</b>	<b>Description</b>
<b>Port</b> (Quatech, Commtech)	From the list, choose a port. The <b>Port</b> parameter defines the port to configure for this driver block.
<b>RTS</b>	Select this check box to control the RTS line for this board.
<b>DTS</b>	Select this check box to control the DTR line for this port.
<b>Port</b> (Diamond)	From the list, choose a port. The <b>Port</b> parameter defines the port to configure for this driver block.
<b>First port address</b> (Diamond)	<p>For Emerald-MM, this value should be the same as the <b>First port address</b> parameter value you select in the Parameter Group: Board Setup dialog of the Send/Receive block. See the Diamond user's manual documentation for the appropriate jumper settings.</p> <p>For Emerald-MM-8, this parameter contains a value based on the <b>Base address</b> value of the configuration register in the Parameter Group: Board Setup dialog of the Send/Receive block. See the Diamond user's manual documentation.</p>

<b>Parameter</b>	<b>Description</b>
<b>Configuration</b> (Mainboard)	<p>From the list, choose a port. This parameter specifies the port whose input modem control line states you want to read.</p> <p>Normally, the ports are set to the following:</p> <p>COM1 — 0x3F8</p> <p>COM2 — 0x2F8</p> <p>COM3 — 0x3E8</p> <p>COM4 — 0x2E8</p> <p>A Custom port is one that is set to an address other than these.</p>
<b>Slot</b> (PCI boards)	<p>If only one board of this type is physically present in the target PC, enter</p> <p>- 1</p> <p>to automatically locate the board.</p> <p>If two or more boards of this type are physically present in the target PC, enter the bus number and the PCI slot number of the board associated with this driver block. Use the format [BusNumber, SlotNumber]. To determine the bus number and the PCI slot number, type</p> <pre>getxpcpci</pre>

## Modem Status

The Modem Status block reads the state of the four input modem control lines.

This block has an output of type `Boolean`. If the input voltage is positive, the output is true. If the input voltage is negative, the output is false.

Parameter	Description
<b>Port</b> (Quatech, Commtech)	From the list, choose a port. The <b>Port</b> parameter defines the port to configure for this driver block.
<b>CTS</b>	Select this check box to monitor the CTS line.
<b>DSR</b>	Select this check box to monitor the DSR line.
<b>RI</b>	Select this check box to monitor the RI line.
<b>DCD</b>	Select this check box to monitor the DCD line.
<b>Sample Time</b>	Base sample time or a multiple of the base sample time.
<b>Port</b> (Diamond)	From the list, choose a port. The <b>Port</b> parameter defines the port to configure for this driver block.
<b>First port address</b> (Diamond)	<p>This parameter specifies the first port whose input modem control line states you want to read. Do not change this value.</p> <p>For Emerald-MM, this value should be the same as the <b>First port address</b> parameter value you select in the Parameter Group: Board Setup dialog.</p> <p>For Emerald-MM-8, this parameter contains a value based on the <b>Base address</b> value in the Parameter Group: Board Setup dialog.</p>

<b>Parameter</b>	<b>Description</b>
<b>Configuration</b> (Mainboard)	<p>From the list, choose a port. This parameter specifies the port whose input modem control line states you want to read.</p> <p>Normally, the ports are set to the following:</p> <p>COM1 — 0x3F8</p> <p>COM2 — 0x2F8</p> <p>COM3 — 0x3E8</p> <p>COM4 — 0x2E8</p> <p>A Custom port is one that is set to an address other than these.</p>
<b>Slot</b> (PCI boards)	<p>If only one board of this type is physically present in the target PC, enter</p> <p>- 1</p> <p>to automatically locate the board.</p> <p>If two or more boards of this type are physically present in the target PC, enter the bus number and the PCI slot number of the board associated with this driver block. Use the format [BusNumber, SlotNumber]. To determine the bus number and the PCI slot number, type</p> <pre>getxpcpci</pre>



## RS-232/422/485 Internal Blocks and Subsystems

This section describes the internal blocks of the RS-232/422/485 boards. Typically, the parameters in these blocks are controlled from the mask parameters dialog for the send/receive subsystem in which they are used.

You might need to access these blocks if you need to modify the RS-232 Quatech subsystems for your use.

---

**Note** Otherwise, do not use these blocks directly.

---

This section includes the following topics:

- “Setup Block” on page 2-49 — Sets up the interface characteristics for the board.
- “Read Hardware FIFO Block” on page 2-51 — Reads characters from the hardware FIFO in the UART.
- “Write Hardware FIFO” on page 2-53 — Writes the data from the input port to the hardware FIFO in the UART for this port.
- “Read Int(errupt) Status” on page 2-55 — Reads the interrupt status for the boards in the system.
- “Enable TX Interrupt” on page 2-57 — Enables the transmitter buffer empty interrupt when data is present in the software FIFO.
- “Filter Interrupt Reason” on page 2-58 — Filters the output of the Read Int(errupt) Status block.
- “Board Setup (Commtech) and Interrupt Check (Quatech)” on page 2-58 — Checks for instances where the hardware IRQ differs from the software for which it is listening.

**Setup Block.** A setup block is a subsystem block that sets up the interface characteristics for the board.

For Quatech boards, this setup block is for one channel or port.

The dialog box for the Setup block contains the following fields:

<b>Parameters</b>	<b>Description</b>
<b>Port</b> (Quatech, Commtech)	From the list, choose a port. The <b>Port</b> parameter defines the port this driver block configures.
<b>Baud Divisor</b> (Commtech)	Enter a divisor integer. The block determines the actual baud rate for a particular channel by dividing the maximum baud rate by this divisor. This number can be different for each channel.
<b>Baud rate</b> (Mainboard, Quatech, Diamond)	From the list, choose a baud rate.
<b>Number of data bits</b>	From the list, choose either 5, 6, 7 or 8 to define the number of data bits for the port.
<b>Number of stop bits</b>	From the list, choose either 1 or 2 to define the number of stop bits for the port.
<b>Parity</b>	From the list, choose None, Even, Odd, Mark or Space. This parameter defines the receive and transfer parity.
<b>Fifo mode</b> (Mainboard, Quatech, Diamond)	From the list, choose 64 deep, 16 deep, or 1 deep. This parameter sets the transmit and receive FIFO depth. The UART can operate with a hardware FIFO depth of 1 character (1 deep), 16 characters (16 deep), or 64 characters (64 deep).
<b>Receive trigger level</b>	From the list, choose 1, quarter full, half full, or almost full. This parameter defines a trigger level for a receive data available interrupt. When the hardware FIFO reaches the level specified in this parameter, the driver asserts the receive data available interrupt.

<b>Parameters</b>	<b>Description</b>
<b>Enable auto RTS/CTS</b>	Select this check box to enable hardware-controlled handshaking using the RTS and CTS modem control lines. If this is not checked, no handshaking is done.
<b>Base Address</b> (Mainboard, ISA, or Diamond)	Enter the base address of the board that you are setting up.  For Diamond-MM-8 boards, this block uses the base address you enter for the Send/Receive block.
<b>IRQ</b> (Diamond-MM-8)	This field contains the value of the <b>IRQ number</b> parameter from the <b>Parameter Group: Board Setup</b> of the Send/Receive block.  For Emerald-MM-8, this block setting programs the board IRQ.
<b>Slot</b> (PCI boards)	If only one board of this type is physically present in the target PC, enter  - 1  to automatically locate the board.  If two or more boards of this type are physically present in the target PC, enter the bus number and the PCI slot number of the board associated with this driver block. Use the format [BusNumber, SlotNumber]. To determine the bus number and the PCI slot number, type  getxpcpci

**Read Hardware FIFO Block.** The Read Hardware FIFO block reads characters from the hardware FIFO in the UART. It then outputs those characters as the low-order byte of an unsigned 32-bit integer vector with a width of 65. This output vector is large enough to hold the maximum number of characters that the hardware FIFO can hold. The first element of the vector specifies the number of data elements in the remainder of the vector.

If the input to the enable port (input port, labeled E) is not true, this block outputs a 0 length vector. The following illustrates the vector.

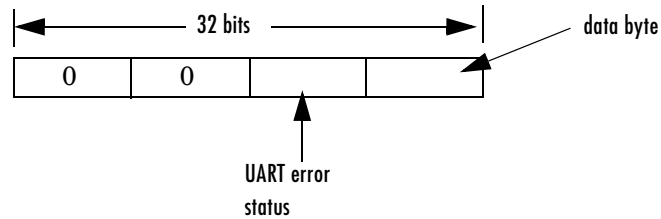

The UART error status can contain one of the following error values:

0x02 — Overrun error

0x04 — Parity error

0x08 — Framing error

0x01 — Break interrupt

The data byte ranges from 0 to 255.

The dialog box for the RS-232 FIFO Read block contains the following fields:

Parameter	Description
<b>Port</b> (Quatech, Commtech)	From the list, choose a port. This block reads the hardware FIFO from this port.
<b>Flush HW FIFO on startup</b>	Select this check box to flush the hardware FIFO when the device starts up.

Parameter	Description
<b>Base address</b> (Mainboard, ISA boards)	Enter the base address of the UART for which you want to read the hardware FIFO.
<b>PCI Slot</b> (PCI boards)	<p>If only one board of this type is physically present in the target PC, enter</p> <p style="padding-left: 2em;">-1</p> <p>to automatically locate the board.</p> <p>If two or more boards of this type are physically present in the target PC, enter the bus number and the PCI slot number of the board associated with this driver block. Use the format [BusNumber, SlotNumber]. To determine the bus number and the PCI slot number, type</p> <p style="padding-left: 2em;">getxpcpci</p>

**Write Hardware FIFO.** The Write Hardware FIFO block writes the data from the input port (labeled E) to the hardware FIFO in the UART for this port. The following pseudocode most accurately describes the behavior of this FIFO.

```

if (enable is false)
    return
else
{
    if (input data empty)
        disable transmitter buffer empty interrupt
        return
    else
        copy input data to HW FIFO
}

```

The dialog box for the RS-232 FIFO Write block contains the following fields:

<b>Parameter</b>	<b>Description</b>
<b>Base address</b> (Mainboard, ISA boards)	Enter the base address of the UART for which you want to write the hardware FIFO.  For Diamond-MM-8 boards, this block uses the base address you enter for the Send/Receive block.
<b>Port</b>	From the list, choose a port. This is the port that this block writes data to.
<b>Assert on Transmit</b> (RS-422/485 boards)	Select None, RTS, or DTR. The board asserts either no bit, the RTS bit, or the DTR bit in the modem control register upon data transmission.  For half duplex operation, set the jumper on the board to send either RTS or DTR signals to the transmit enable gate. See the user's manual documentation specific to your board for further information.
<b>PCI Slot</b> (PCI boards)	If only one board of this type is physically present in the target PC, enter  - 1  to automatically locate the board.  If two or more boards of this type are physically present in the target PC, enter the bus number and the PCI slot number of the board associated with this driver block. Use the format [BusNumber, SlotNumber]. To determine the bus number and the PCI slot number, type  getxpcpci

**Read Interrupt Status.** The Read Interrupt Status block reads the interrupt status for the boards in the system. The output for this block is a vector with one 32-bit element for each port. Each element contains two pieces of information for that port, where the four bytes are

[0, 0, IIR, Reason]

The Read Interrupt Status block has signal output with the following format:

This output is a vector of integers. The values in the reason byte and their definitions are

- 0 — This UART did not cause this interrupt.
- 1 — Receive characters are available.
- 2 — Transmit holding register is empty.
- 3 — Modem status has changed (ignored).

This second byte is the value read from the Interrupt Reason Register (IIR). This register is specific to the 16450, 16550, and 16750 types of UARTs. Several bites in this register indicate the active hardware FIFO depth and the maximum number of characters that can be written in the transmitter empty interrupt handlers to the transmit hardware FIFO.

The dialog box for the Read Interrupt Status block contains the following fields:

Parameter	Description
<b>Base address 1</b> (Mainboard, ISA boards)	Enter the base address of the first UART for which you want to read the interrupt status.
<b>Base address 2</b> (Mainboard, ISA boards)	Enter the base address of the second UART for which you want to read the interrupt status.

Parameter	Description
<b>PCI Slot</b> (PCI boards)	<p>If only one board of this type is physically present in the target PC, enter</p> <p>- 1</p> <p>to automatically locate the board.</p> <p>If two or more boards of this type are physically present in the target PC, enter the bus number and the PCI slot number of the board associated with this driver block. Use the format [BusNumber , SlotNumber]. To determine the bus number and the PCI slot number, type</p> <p>getxpcpci</p>
<b>First to Fourth port address</b> (Diamond-MM)	<p>These parameters contain the address of the port for which you want to read the interrupt status.</p> <p>Starting from the <b>First port address</b> parameter value you select in the Parameter Group: Board Setup dialog of the Send/Receive block, the subsequent parameters contain the incremental port addresses.</p>
<b>First to Eighth port address</b> (Diamond-MM-8)	<p>These parameters contain the addresses of the ports for which you want to read the interrupt status.</p> <p>Starting from the <b>Base address</b> parameter value in the Parameter Group: Board Setup dialog of the Send/Receive block, the subsequent parameters contain the incremental port addresses.</p>
<b>Interrupt status address</b> (Diamond)	<p>This parameter contains the address for the interrupt status. This parameter derives from the configurations you define in the Parameter Group dialog of the Send/Receive block.</p>



**Enable TX Interrupt.** The Enable TX Interrupt block enables the transmitter buffer empty interrupt when data is present in the software FIFO.

<b>Parameter</b>	<b>Description</b>
<b>Base address</b> (Mainboard, ISA boards)	Enter the base address of the UART for which you want to enable the transmitter buffer empty interrupt.
<b>Port</b> (Quatech, Commtech)	From the list, choose a port. This parameter specifies the input port for which this block enables the interrupt.
<b>PCI Slot</b> (PCI boards)	<p>If only one board of this type is physically present in the target PC, enter</p> <p>- 1</p> <p>to automatically locate the board.</p> <p>If two or more boards of this type are physically present in the target PC, enter the bus number and the PCI slot number of the board associated with this driver block. Use the format [BusNumber , SlotNumber]. To determine the bus number and the PCI slot number, type</p> <p>getxpcpci</p>

The input port for controlling this is a Boolean value. If the input port value is true, the Enable Transmit Interrupt block enables the transmitter buffer empty interrupt in the UART. After the interrupt service routine empties the software FIFO, the interrupt is disabled.

**Filter Interrupt Reason.** The Filter Interrupt Reason block filters the output of the Read Int(errupt) Status block. If the condition that the interrupt query block reads from the IIR register matches the one chosen here, the output is true.

This block is used exclusively inside the interrupt service subsystem for this board.

Parameter	Description
Port	From the list, choose a port. This parameter specifies the port from which this block gets control data.
Filter value	From the list, choose Receive data, Transmitter empty, or Modem status change. This parameter specifies the interrupt reason that this filter block is looking for.  Note that Modem status change currently has no effect because the interrupt is never enabled.

**Board Setup (Commtech) and Interrupt Check (Quatech).** (Quatech and Commtech only) The Board Setup and Interrupt Check block checks for instances where the hardware IRQ differs from the software for which it is listening. This block compares the software-selected interrupt against the value for which the board

(PCI only) is configured. This check prevents IRQ mismatches. For the Commtech Fastcom board, the corresponding block also sets up the board clock.

<b>Parameter</b>	<b>Description</b>
<b>PCI Slot</b>	<p>If only one board of this type is physically present in the target PC, enter</p> <p>-1</p> <p>to automatically locate the board.</p> <p>If two or more boards of this type are physically present in the target PC, enter the bus number and the PCI slot number of the board associated with this driver block. Use the format [BusNumber , SlotNumber]. To determine the bus number and the PCI slot number, type</p> <p>getxpcpci</p>
<b>Clock Bits</b> (Commtech)	<p>Enter the number of clock bits to control a clock generator common to both channels. This parameter adjusts the master clock of both channels.</p>
<b>IRQ Line Number</b>	<p>From the list, select an IRQ line number from 5 to 15, inclusive.</p>

## xPC Target RS-232 Drivers (Conventional)

This section describes the components that make up the RS-232 conventional drivers, and how you can create a model using these drivers. This section includes the following topics:

- “Simulink Blocks for RS-232 I/O (Conventional)” on page 2-60 — Add setup, send, send/receive, and receive blocks to your Simulink model.
- “MATLAB Message Structures for RS-232 I/O (Conventional)” on page 2-61 — Create message structures to sequence instructions to and from the RS-232 device.
- “RS-232 Synchronous Mode (Conventional)” on page 2-62 — Add synchronous driver blocks to have the device wait for a response before continuing with other computations.
- “RS-232 Asynchronous Mode (Conventional)” on page 2-71 — Add asynchronous driver blocks if the device does not have to wait for a response before continuing with other computations.
- “RS-232 Simulink Block Reference (Conventional)” on page 2-83 — Description of the RS-232 blocks for the conventional drivers.
- “RS-232 MATLAB Structure Reference (Conventional)” on page 2-88 — Description of the RS-232 MATLAB structure for messages.
- “RS-232 Binary Mode (Conventional)” on page 2-93 — Add binary driver blocks to transfer raw data.

### Simulink Blocks for RS-232 I/O (Conventional)

To support the use of RS-232, the xPC Target I/O library includes a set of RS-232 driver blocks. These driver blocks can be added to your Simulink model to provide inputs and outputs using one or more of the RS-232 ports.

- **RS-232 Setup** — One setup block is needed for each RS-232 port you use in your model. The setup block does not have any inputs or outputs, but sends the initialization and termination messages.
- **RS-232 Send/Receive (Synchronous Mode)** — Send/Receive blocks have inputs and outputs from your Simulink model, and wait for responses to messages sent and received.
- **RS-232 Send (Asynchronous Mode)** — Send blocks have inputs from your Simulink model, and wait for responses to messages sent.

- **RS-232 Receive (Asynchronous Mode)** — Receive blocks have output from your Simulink model, and wait for responses to messages received.

## **MATLAB Message Structures for RS-232 I/O (Conventional)**

Communication is through a series of messages passed back and forth between the target PC and the RS-232 device. To accomplish this, the messages sent to the RS-232 device must be in a format that the device understands. Likewise, the target PC must know how to interpret the data returned from the RS-232 device.

xPC Target uses MATLAB structures to create messages and map the input and output ports on the RS-232 driver blocks to the data written and read from the RS-232 devices. The RS-232 Setup block sends the messages in the initialization structure after downloading the target application. The RS-232 Send/Receive, RS-232 Send, and RS-232 Receive blocks repeat the sending of the messages in the send/receive, send, and receive structures during each sample interval. When the target application stops running, the RS-232 Setup block sends the messages in the termination structure.

Below is an example of the send and receive message structure for asynchronous communication. In this example, an external RS-232 device requires a string with two floating-point numbers. The numbers are entered from the Simulink model to the first and second input ports of the RS-232 Send driver block. The RS-232 device sends back two floating-point numbers that are passed to the outputs of the RS-232 Receive driver block.



- “Creating RS-232 Message Structures (Synchronous)” on page 2-68 — Create the initialize, send/receive, and termination message structures you need in the MATLAB workspace.

### Notes for RS-232 Synchronous Mode

For the example in this section, assume an external device (RS-232 device) includes a D/A conversion module with four independent channels and an output voltage range of -10 to 10 volts. Also assume that the external device outputs a new voltage if it receives a serial string with a value to identify the D/A channel and the voltage value.

Use a Constant block as an input to the Send/Receive block to select the D/A channel, and a Signal Generator block as a source for voltage values. Also, set up the message structures to receive a confirmation message from the external module after the target PC sends a message string to the device.

In synchronous mode, the data is sent to the external device and the block waits until a response (for example, data) is received from the device before the execution of the block is considered to be complete. In other words, the I/O driver *blocks* until an answer is received from the external device or it reaches a time-out.

When it is necessary to receive a response before continuing with other computations, synchronous mode is used, which implies that the Send & Receive block is placed in your model. This block includes both input and output lines.

### Adding RS-232 Driver Blocks (Synchronous)

You add RS-232 driver blocks to your Simulink model when you want to use the serial ports on the target PC for I/O.

After you create a Simulink model, you can add xPC Target driver blocks and define the initialization, send/receive, and termination message structures:

- 1 In the MATLAB command window, type

```
xpcLib
```

The xPC Target driver block library opens.

- 2 Double-click the RS-232 group block.

A window with blocks for RS-232 drivers opens.

**Note** This library contains two main sections, Composite drivers and Conventional drivers. Refer to the Conventional drivers section, where there are two setup blocks. The second block is included for compatibility with xPC Target Version 1.0.

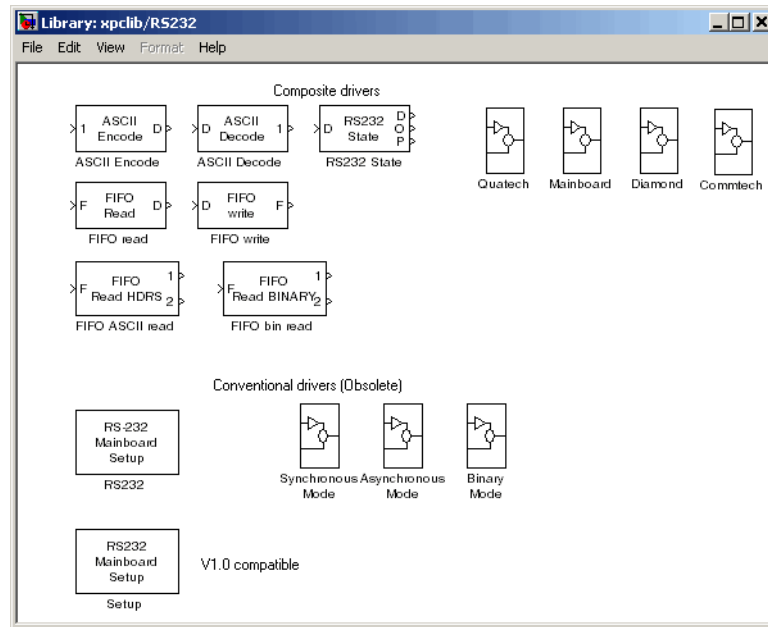

Alternatively, you can access the xPC Target block library from the Simulink Library Browser. In the Simulink window, and from the **View** menu, click **Show Library Browser**. In the left pane, double-click **xPC Target**, and then click **RS-232**.

- 3 From the Conventional drivers area, drag and drop an RS-232 Setup block to your Simulink model.



- 4 In the Library window, double-click the RS-232 Synchronous mode group block. The library window with blocks for RS-232 synchronous communication opens.

---

**Note** This library contains two Setup and Receive blocks. The second block is included for compatibility with xPC Target Version 1.0.

---

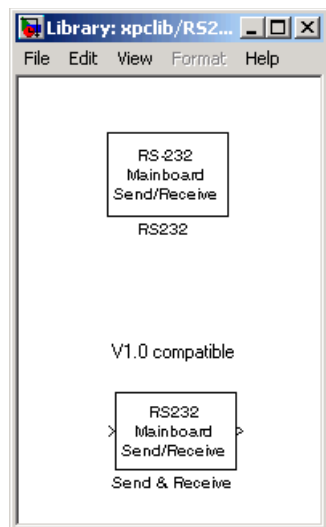

- 5 Drag and drop an RS-232 Send/Receive block to your Simulink model.
- 6 Add a Signal Generator and a Constant block.

Your model should look similar to the figure shown below. Note that inputs on the RS-232 Send/Receive block are not defined or visible. The inputs are defined in a MATLAB message structure, and visible only after you load that structure into the MATLAB workspace and update your Simulink model.

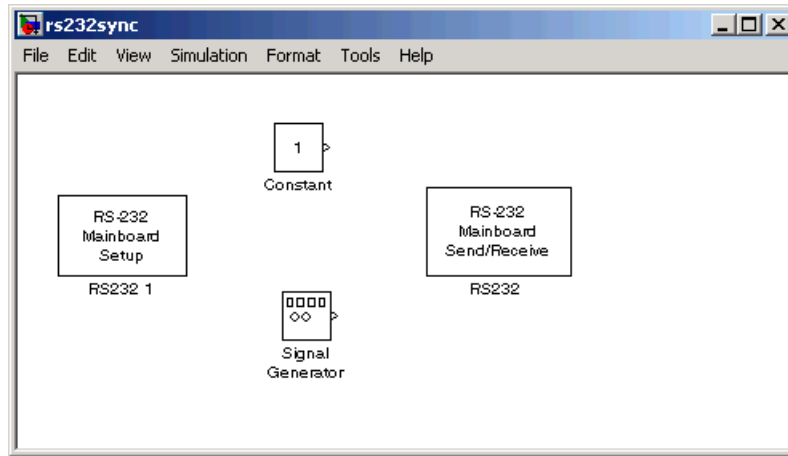

- 7 Double-click the RS-232 Setup block. Enter values to configure the COM1 port on the target PC.

For example, if the target PC is connected to COM1, and serial communication is set to 5760 baud, 8 data bits, and 1 stop bit, your Block Parameter dialog box should look similar to the figure shown below.

---

**Note** If you are not using an initialization or termination structure, in the **Initialization Struct** and **Termination Struct** boxes, enter the empty matrix `[]`.

---

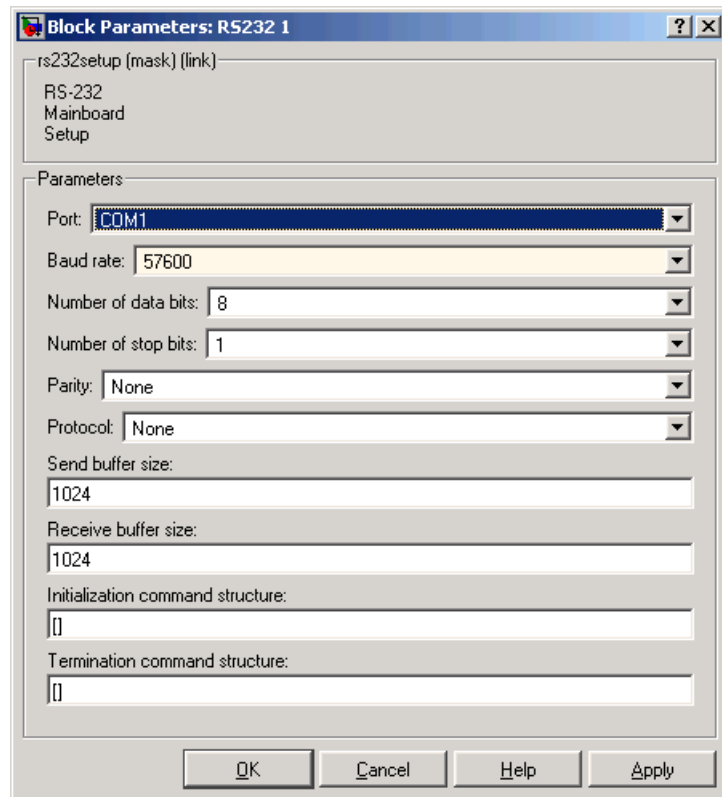

For more information on entering the block parameters, see “RS-232 Setup Block” on page 2-84. For the procedure to create the initialization and termination structures, see “RS-232 MATLAB Structure Reference (Conventional)” on page 2-88.

- 8 Click **OK**. The Block Parameters dialog box closes.
- 9 Double-click the RS-232 Send/Receive block. The Block Parameters dialog box opens.
- 10 From the **Port** list, select either COM1 or COM2. For this example, select COM1. In the **Message struct name** box, enter the name for the MATLAB structure this block uses to send messages to the COM1 port. The name of the message

structure is not the name of the M-file, but the name of the structure created with the M-file.

In the **Sample Time** box, enter the sample time or a multiple of the sample time you entered in the Receive block.

Your Block Parameter dialog box should look similar to the figure shown below.

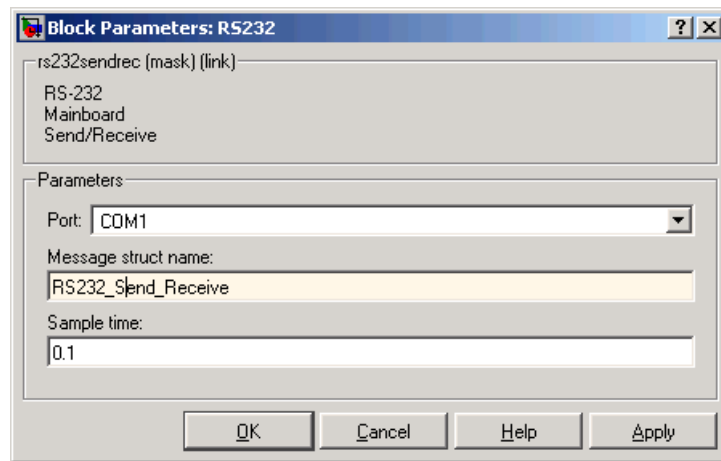

For information on entering the block parameters, see “RS-232 Send/Receive Block (Synchronous)” on page 2-86. For the procedure to create the send/receive structure, see “RS-232 MATLAB Structure Reference (Conventional)” on page 2-88.

**11** Click **OK**. The Block Parameters dialog box closes.

Your next task is to create the MATLAB message structures that the RS-232 driver blocks use to sequence commands to the RS-232 device. See “Creating RS-232 Message Structures (Synchronous)” on page 2-68.

### Creating RS-232 Message Structures (Synchronous)

RS-232 drivers use MATLAB structures to send and receive messages and map the input and output ports on the RS-232 driver blocks to the data written and read from the RS-232 devices.

After you add an RS-232 Setup and RS-232 Send/Receive block to your Simulink model, you can create the message structures to communicate with the RS-232 devices. You need to create and load these structures into the MATLAB workspace before you build your target application. The easiest way to create these structures is using an M-file and loading that M-file into the MATLAB workspace.

- 1 In the MATLAB Command Window, and from the **File** menu, point to **New**, and then click **M-file**.

A MATLAB text editor window opens.

- 2 Enter the initialization, send/receive, and termination messages. Each message is an element in a MATLAB structure array. For information and examples of this structure, see “RS-232 MATLAB Structure Reference (Conventional)” on page 2-88.

For example, assume that you have an external RS-232 device with a D/A module that requires a string in the format 'identifier, channel, value;\n'. identifier is any string. channel is an integer value between 1 and 2, defining which D/A channel to update. value is a floating-point value indicating the new voltage for the D/A output.

Additionally, when the external device receives a legal string, it accepts the string as an input message and returns the message 'noerror;\n'. This message is provided as a confirmation. As an example, you can type the following.

---

**Note** Field names in the structures are case sensitive.

---

```
RS232_Send_Receive(1).SendData = 'da_1234,%d,%f,;\n';
RS232_Send_Receive(1).InputPorts = [1 2];
RS232_Send_Receive(1).RecData = 'noerror\n';
RS232_Send_Receive(1).Timeout = 0.01;
RS232_Send_Receive(1).EOM = 1;
```

- 3 From the **File** menu, click **Save As**. In the Save as file dialog box, enter the name of the M-file script. For example, enter

```
RS232Sync_Messages.m
```

- 4 Close the text editing window.
- 5 In the MATLAB Command Window, type the name of the M-file you created with the RS-232 structures. For example, type

```
RS232Sync_Messages
```

MATLAB loads and runs the M-file to create the message structures in the MATLAB workspace needed by the RS-232 driver blocks.

- 6 Open your Simulink model, or press **Ctrl+D**.

Simulink updates the RS-232 driver blocks with the information from the structures. For example, Simulink adds inputs and outputs defined in the structures to the blocks.

- 7 Connect the input and output ports on the RS-232 driver blocks to other blocks in your Simulink model.

Your model should look similar to the figure shown below.

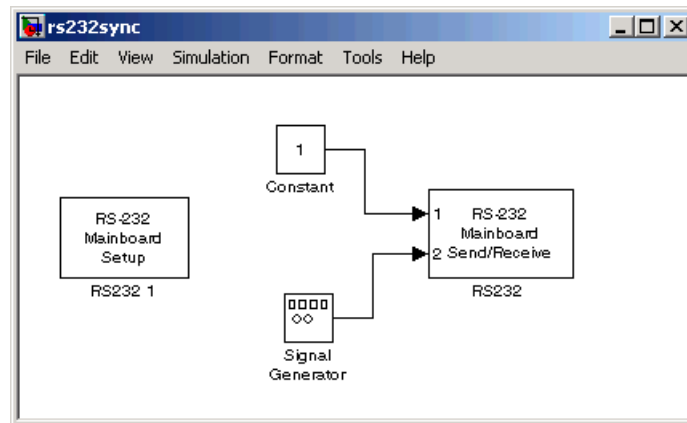

- 8 Set the `PreLoadFcn` for your Simulink model to load the message structures when you open your model. For example, if you saved the message structures in the M-file `RS232Sync_messages`, type

```
set_param(gcs, 'PreLoadFcn', 'RS232Sync_messages.m')
```

---

**Note** If you do not manually load the message structures before opening your Simulink model, or have the message structures automatically loaded with the model, the port connections to the RS-232 driver break.

---

Your next task is to build and run the target application. However, the example above only illustrates how to set up the dialog entries when using the Send & Receive block. Without an external RS-232 device to receive the messages and return a reply `'no error\n'`, this model cannot run successfully on your target PC. It will *block* and wait for a reply each time the application sends a message.

## RS-232 Asynchronous Mode (Conventional)

Use asynchronous mode when you do not need a response before continuing with other computations. You can achieve faster sample rates with asynchronous mode because neither the Send nor Receive block waits for a reply. As a result, the asynchronous mode blocks do not *block* as do the synchronous mode blocks. The application updates the received outputs only when the entire package of data is received from the external device. This section includes the following topics:

- “Notes for RS-232 Asynchronous Mode” on page 2-72 — Overview of RS-232 communications with xPC Target blocks.
- “Adding RS-232 Driver Blocks (Asynchronous)” in Chapter 2 — Add the setup, send, and receive blocks you need to your Simulink model for RS-232 communication.
- “Creating RS-232 Message Structures (Asynchronous)” on page 2-79 — Create the initialize, send/receive, and termination message structures you need in the MATLAB workspace.
- “Building and Running the Target Application (Asynchronous)” on page 2-81 — Run a real-time application with RS-232 communication.

### Notes for RS-232 Asynchronous Mode

For the example in this section, two asynchronous mode blocks illustrate how you can test RS-232 I/O on the target PC in a simple loop-back test. This simple but effective test lets you check that the RS-232 Send and RS-232 Receive blocks work correctly with your system using minimal hardware.

In this loop-back test, you use the COM1 port for sending signals and the COM2 port for receiving signals. A NULL modem serial cable connects COM1 to COM2 so that any messages sent from the target PC through COM1 are received by COM2 on the same target PC.

Use a Sine Wave block as an input to an RS-232 Send block that you connect to the COM1 port. Connect the COM2 port to an RS-232 Receive block. The signal received from this block is then passed through a Gain block of -1.

In the asynchronous mode, data is sent without waiting for response data to be received. The Send block completes execution immediately upon completing the Send transfer. The Receive block completes execution upon completing the Receive transfer or when no more data is ready to be retrieved.

For sending data in asynchronous mode, use the RS-232 Send block. This block only has input lines for the data to be sent. For receiving data, you must use the Receive block. This block only has output lines for the data to be received. Outputs are updated only when the entire package of data is received from the external device.

### Adding RS-232 Driver Blocks (Asynchronous)

You add RS-232 driver blocks to your Simulink model when you want to use the serial ports on the target PC for I/O.

After you create a Simulink model, you can add xPC Target driver blocks and define the initialization, send, receive, and termination message structures:

- 1 In the MATLAB Command Window, type

```
xpclib
```

The xPC Target driver block library opens.

- 2 Double-click the RS-232 group block.

A window with blocks for RS-232 drivers opens.



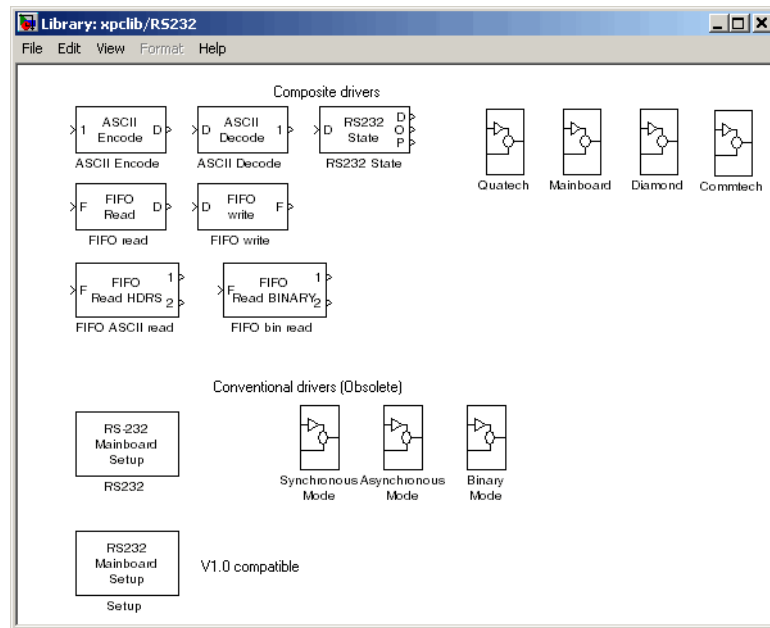

Alternatively, you can access the xPC Target block library from the Simulink Library Browser. In the Simulink window, and from the **View** menu, click **Show Library Browser**. In the left pane, double-click **xPC Target**, and then click **RS-232**.

- 3** Drag and drop two RS-232 Setup blocks to your Simulink model.
- 4** In the **Library** window, double-click the RS-232 Asynchronous mode group block. The library window containing blocks for RS-232 Synchronous communication opens.

---

**Note** This library contains two send and two receive blocks. The second block is included for compatibility with xPC Target Version 1.0.

---

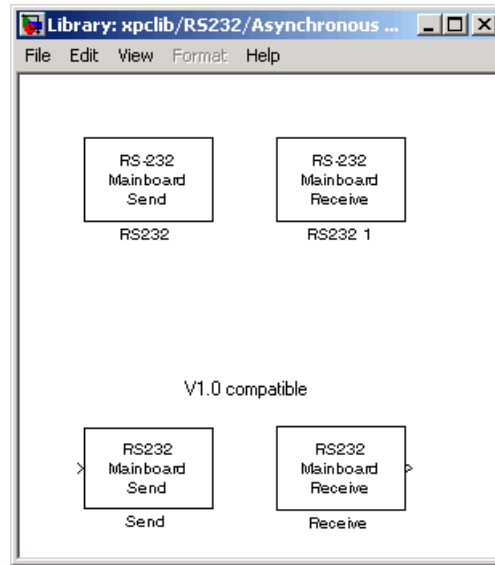

Alternatively, you can access the xPC Target block library from the Simulink Library Browser. In the Simulink window, and from the **View** menu, click **Show Library Browser**. In the left pane, double-click **xPC Target**, and then click **RS-232**.

- 5 Drag and drop the RS-232 Send and RS-232 Receive blocks into your Simulink model.
- 6 Add a Signal Generator, Gain, and xPC Target Scope block.

Your model should look similar to the figure below. Note that you cannot connect to the inputs on the RS-232 Send block and the outputs on the RS-232 Receive block, because they are not defined or visible. The inputs and outputs are defined in a MATLAB message structure, and visible only after you load that structure into the MATLAB workspace and update your Simulink model.

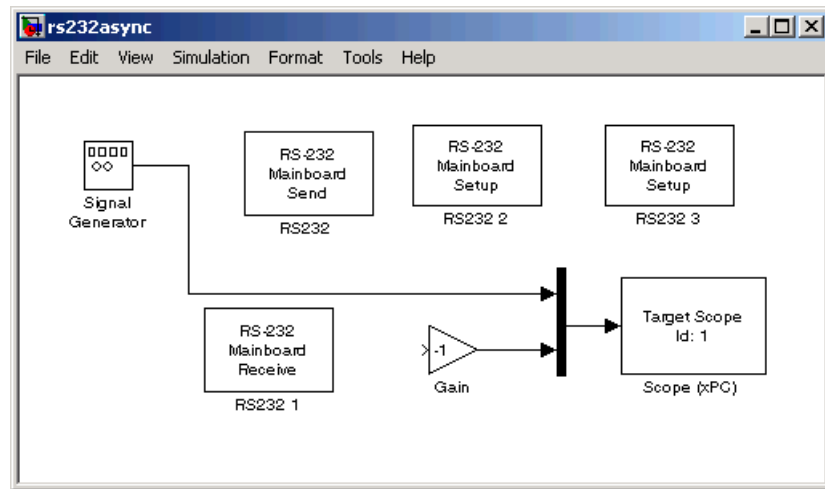

- 7 Double-click the first RS-232 Setup block. Enter values to configure the COM1 port on the target PC.

For example, if the COM1 and COM2 ports of the target are connected with a RS-232 NULL modem cable, and you set serial communication to 57600 baud, 8 data bits, and 1 stop bit. Your Block Parameters dialog box should look similar to the figure shown below.

---

**Note** If you are not using an initialization or termination structure, in the **Initialization Struct** and **Termination Struct** boxes, enter the empty matrix `[]`.

---

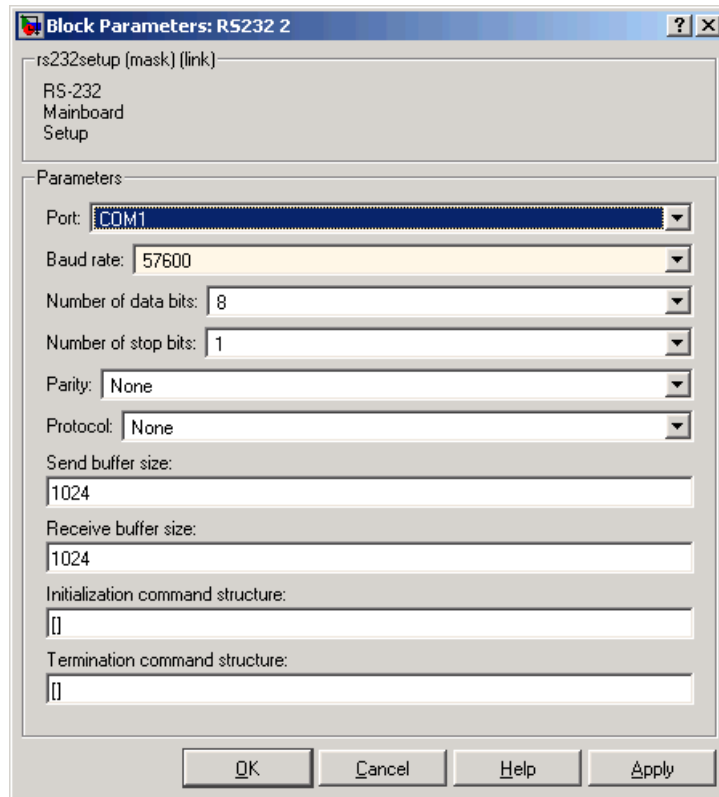

For more information on entering the block parameters, see “RS-232 Setup Block” on page 2-84. For the procedure to create the initialization and termination structures, see “RS-232 MATLAB Structure Reference (Conventional)” on page 2-88.

- 8 Click **OK**. The Block Parameters dialog box closes.
- 9 Repeat the previous setup for the second RS-232 Setup block and the COM2 port. Use the same **Baudrate**, **Databits**, **Stopbits**, **Parity**, and **Protocol** that you entered in the first RS-232 Setup block.
- 10 Double-click the Send block. The Block Parameters dialog box opens.

- 11** From the **Port** list, select either COM1 or COM2. For this example, select COM1. In the **Message struct name** box, enter the name for the MATLAB structure this block uses to send messages to the COM1 port. In the **Sample Time** box, enter the sample time or a multiple of the sample time you entered in the RS-232 Receive block.

Your Block Parameters dialog box should look similar to the figure shown below.

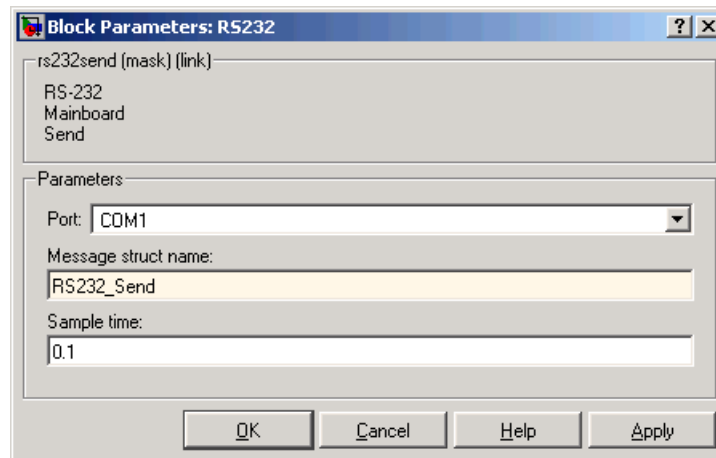

For information on entering the block parameters, see “RS-232 Send Block (Asynchronous)” on page 2-87. For the procedure to create the send structure, see “RS-232 MATLAB Structure Reference (Conventional)” on page 2-88.

- 12** Click **OK**. The Block Parameters dialog box closes.
- 13** Double-click the RS-232 Receive block.
- 14** The Block Parameters dialog box opens.
- 15** From the **Port** list, select either COM1 or COM2. For this example, select COM2. In the **Message Struct Name** box, enter the name for the MATLAB structure this block uses to receive messages from the COM2 port. In the

**Sample Time** box, enter the sample time or a multiple of the sample time you entered in the RS-232 Send block.

Your Block Parameters dialog box should look similar to the figure shown below.

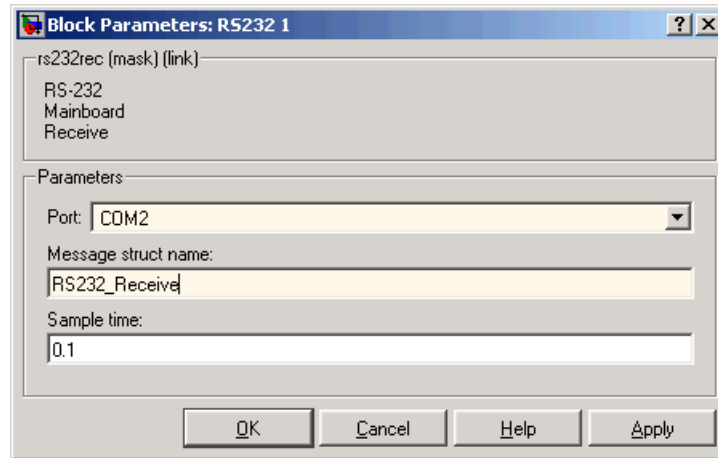

For information on entering the block parameters, see “RS-232 Receive Block (Asynchronous)” on page 2-87. For the procedure to create the send structure, see “RS-232 MATLAB Structure Reference (Conventional)” on page 2-88.

- 16** Click **OK**. The Block Parameters dialog box closes.
- 17** Double-click the Signal Generator block and enter parameters. For example, from the **Wave Form** list, select sine. In the **Amplitude** and **Frequency** boxes, enter 1. From the **Units** list, select Hertz. Click **OK**.
- 18** Double-click the Gain block and enter parameters. For example, in the Gain box, enter -1. Click **OK**.

Your next task is to create the MATLAB message structures that the RS-232 driver blocks use to sequence commands to the RS-232 device. See “Creating RS-232 Message Structures (Synchronous)” on page 2-68.

## Creating RS-232 Message Structures (Asynchronous)

RS-232 drivers use MATLAB structures to send and receive messages and map the input and output ports on the RS-232 driver blocks to the data written and read from the RS-232 devices in synchronous mode.

After you add the RS-232 Setup, Asynchronous Send, and Asynchronous Receive blocks to your Simulink model, you can create the message structures to communicate with the RS-232 devices. You need to create and load these structures into the MATLAB workspace before you build your target application. The easiest way to create these structures is to use an M-file and load that M-file into the MATLAB workspace. See `xpcrs232v2.mdl` in the `xpcdemos` directory for an example model. That example sends and receives two floating-point numbers. In that example, both floating-point number fields for `SendData` are filled from `InputPorts 1` because only one input port is specified. In the case of `RecData`, the first floating-point number field is sent to `OutputPorts 1`, but the second floating-point number field is ignored because only one output port is specified.

The following procedure describes how to create an RS-232 message structure to send and receive one floating-point number:

- 1 In the MATLAB Command Window, and from the **File** menu, point to **New**, and then click **M-file**.

A MATLAB text editor window opens.

- 2 Enter the initialization, send, receive, and termination messages. Each message is an element in a MATLAB structure array with a series of fields. For information and examples of these fields, see “RS-232 MATLAB Structure Reference (Conventional)” on page 2-88.

For example, if you want to send and receive one floating-point number, type the following. In this example, the floating-point number field for `SendData` is filled from `InputPorts 1`. In the case of `RecData`, the floating-point number field is sent to `OutputPorts 1`.

---

**Note** Field names in the structures are case sensitive.

---

```
RS232_Send(1).SendData = 'start,%f,%f,stop;\r';
RS232_Send(1).InputPorts = [1];
RS232_Send(1).Timeout = 0.01;
RS232_Send(1).EOM = 1;

RS232_Receive(1).RecData = 'start,%f,%f,stop;\r';
RS232_Receive(1).OutputPorts = [1];
RS232_Receive(1).Timeout = 0.01;
RS232_Receive(1).EOM = 1;
```

---

**Note** If you do not manually load the message structures before opening your Simulink model, or have the message structures automatically loaded with the model, the port connections to the RS-232 blocks break.

---

- 3** From the **File** menu, click **Save As**. In the Save As File dialog box, enter the name of the M-file. For example, enter

```
RS232Async_Messages.m
```

- 4** Close the text editing window.
- 5** In the MATLAB Command Window, type the name of the M-file you created with the RS-232 structures. For example, type

```
RS232Async_Messages
```

MATLAB loads and runs the M-file to create the message structures in the MATLAB workspace needed by the RS-232 driver blocks.

- 6** Open your Simulink model, or press **Ctrl+D**.

Simulink updates the RS-232 driver blocks with the information from the structures. For example, Simulink adds the inputs and outputs defined in the structures to the blocks.

- 7** Connect the input and output ports on the RS-232 driver blocks to other blocks in your Simulink model.

Your model should look similar to the figure shown below.



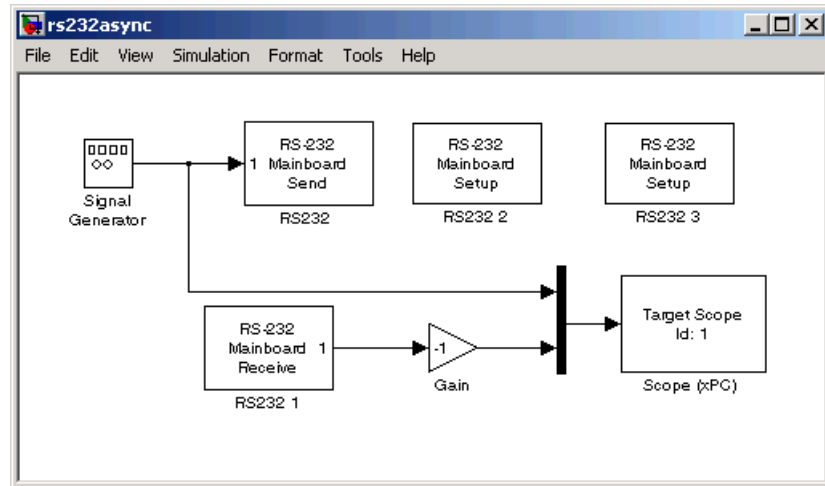

- 8** Set the preload function for your Simulink model to load the message structures when you open the model. For example, if you saved the message structures in the M-file `RS232async_messages`, type
- ```
set_param(gcs, 'PreLoadFcn', 'RS232async_messages')
```

---

**Note** If you do not manually load the message structures before opening your Simulink model, or have the message structures automatically loaded with the model, the port connections to the RS-232 blocks break.

---

Your next task is to build and run the target application.

### Building and Running the Target Application (Asynchronous)

xPC Target and Real-Time Workshop create C code from your Simulink model. You can then use a C compiler to create executable code that runs on the target PC.

After you have added the RS-232 blocks for asynchronous mode to your Simulink model, and created and loaded the RS-232 structures into the MATLAB workspace, you can build your target application.

---

**Note** You cannot use a serial port to communicate between the host PC and target PC with this example. You can only use COM1 if it is not already in use for host-target communications.

---

- 1** In the Simulink window, and from the **Tools** menu, point to **Real-Time Workshop**, and then click **Build Model**.
- 2** In the MATLAB Command Window, type  
`+tg or tg.start or start(tg)`

The target application begins running in real time.

For each sample period, the RS-232 messages you entered in the RS-232 send and receive message structures are executed.

In this example, the target PC displays the inverted waveform. The RS-232 Send and RS-232 Receive blocks require a minimum delay or one sample to send the data and also receive it. When running at faster sample rates, several sample intervals might elapse while one set of data is transmitted, because RS-232 communication is not particularly fast. The sample delay just described is not visible in this example.

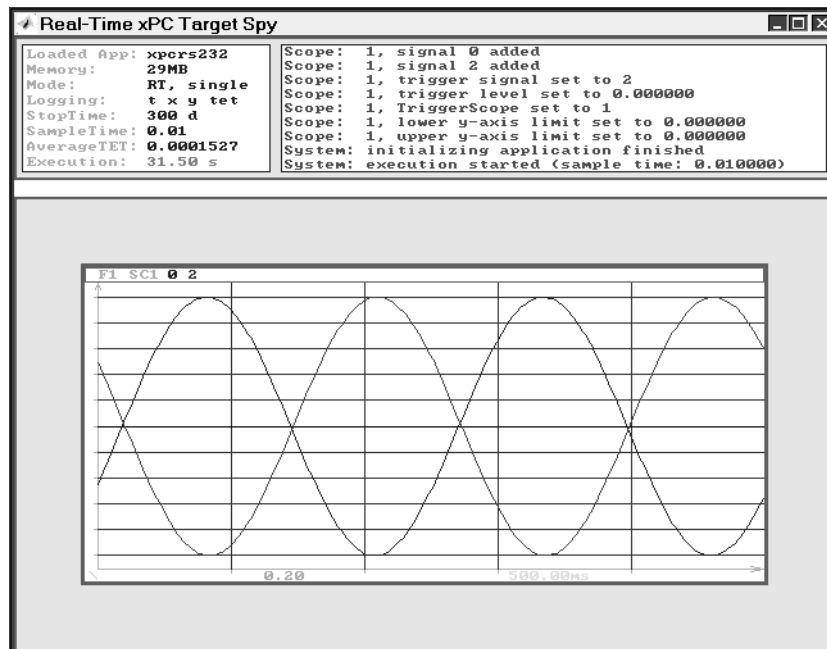

You can extend this example for multiple D/A channels by simply adding more input signals and modifying the format string to have additional '%f' format specifiers.

---

**Note** This example requires that you not use host PC to target PC communication using a serial port because that would block that COM port and the example would not operate.

---

## RS-232 Simulink Block Reference (Conventional)

xPC Target supports RS-232 communication with driver blocks in your Simulink model and message structures in the MATLAB workspace.

This section includes the following topics:

- “RS-232 Setup Block” on page 2-84 — Sends the initialize and termination messages. You need one Setup block for each RS-232 port you use in your model.
- “RS-232 Send/Receive Block (Synchronous)” on page 2-86 — Sequences the send and receive messages for synchronous serial communication.
- “RS-232 Send Block (Asynchronous)” on page 2-87 — Sequences the send messages.
- “RS-232 Receive Block (Asynchronous)” on page 2-87 — Sequences the receive messages.

### RS-232 Setup Block

The Block Parameters dialog box for the RS-232 Setup block contains the following fields:

| Parameter                  | Description                                                                                                                                                                                        |
|----------------------------|----------------------------------------------------------------------------------------------------------------------------------------------------------------------------------------------------|
| <b>Port</b>                | From the list, select COM1, COM2, COM3, or COM4. This is the serial connection the target PC uses to communicate with the RS-232 device.                                                           |
| <b>Baud rate</b>           | From the list, select 115200, 57600, 38400, 19200, 9600, 4800, 2400, 1200, 300, or 110.                                                                                                            |
| <b>Number of data bits</b> | From the list, select either 7 or 8.                                                                                                                                                               |
| <b>Number of stop bits</b> | From the list, select 1 or 2.                                                                                                                                                                      |
| <b>Parity</b>              | From the list, select None, Odd, or Even.                                                                                                                                                          |
| <b>Protocol</b>            | From the list, select None or X0nX0ff. If your serial device does not support hardware handshaking, or your application software requires X0n/X0ff handshaking, you might need to select X0n/X0ff. |
| <b>Send buffer size</b>    | Enter the size, in bytes, of the send buffer.                                                                                                                                                      |

| Parameter                               | Description                                                                                                                                                                                                                                                                                                                                                                                                                 |
|-----------------------------------------|-----------------------------------------------------------------------------------------------------------------------------------------------------------------------------------------------------------------------------------------------------------------------------------------------------------------------------------------------------------------------------------------------------------------------------|
| <b>Receive buffer size</b>              | <p>Enter the size, in bytes, of the receive buffer.</p> <p>The <b>Send Buffer Size</b> and <b>Receive Buffer Size</b> must be large enough to hold the data to be sent or received during each model step. It is important to be aware that the buffers must also be large enough to store old data from a prior model step in the event that the entire data transmission was not completed during the prior step.</p>     |
| <b>Initialization command structure</b> | <p>Enter the name of the structure containing the initialization messages and the expected acknowledgments when the model is initialized. If you are not using initialization messages, enter an empty matrix in this box.</p> <p>For information on creating this structure, see “Creating RS-232 Message Structures (Synchronous)” on page 2-68 and “Creating RS-232 Message Structures (Asynchronous)” on page 2-79.</p> |
| <b>Termination command structure</b>    | <p>Enter the name of the structure containing the termination messages and expected acknowledgments when the model is terminated. If you are not using termination messages, enter an empty matrix in this box.</p>                                                                                                                                                                                                         |

The RS232 Setup block defines the number of databits, baudrate, protocol, and so on for each COM port used in your Simulink model. Each model that uses RS232 I/O must have one RS232 Setup block for each COM port in the model. The RS232 Setup block does not have any inputs or outputs.

If your host PC and target PC are connected using serial communication, one COM port on your target PC is dedicated for communication with your host PC. You cannot use this COM port in your block diagram as an I/O device. For example, if the target PC uses COM1 for communication with the host PC, COM1 cannot be used by your block diagram. An error message is displayed if you use COM1 as an I/O device in your block diagram. The error message appears when you attempt to build and download the target application. In this

example, you must use COM2 as an I/O device in your block diagram. If you are using TCP/IP as your host PC to target PC communications protocol, then you can use any COM ports with RS-232 I/O drivers in your block diagram.

### **RS-232 Send/Receive Block (Synchronous)**

The Block Parameters dialog box for the Synchronous Send & Receive block contains the following fields:

| <b>Parameter</b>           | <b>Description</b>                                                                                                                                                                                                                                                                                                                                                                                                                                                                                                                                                                                         |
|----------------------------|------------------------------------------------------------------------------------------------------------------------------------------------------------------------------------------------------------------------------------------------------------------------------------------------------------------------------------------------------------------------------------------------------------------------------------------------------------------------------------------------------------------------------------------------------------------------------------------------------------|
| <b>Port</b>                | From the list, select COM1, COM2, COM3, or COM4. This list allows you to define which COM port is used to send and receive the data. The model must contain one Setup block for each COM port you use to send and receive data. Otherwise, an error message is displayed. Note that data is sent and received on the same COM port.                                                                                                                                                                                                                                                                        |
| <b>Message struct name</b> | Enter the name of the MATLAB structure this block uses to send and receive messages and data to an RS-232 device. For information to create this structure, see “Creating RS-232 Message Structures (Synchronous)” on page 2-68.                                                                                                                                                                                                                                                                                                                                                                           |
| <b>Sample time</b>         | This entry allows you to define the sample time of the block. Because this block waits for data to be received from the RS-232 external device before the block finishes executing, small sample times are not suitable with synchronous mode. You must allow sufficient time for both the RS232 send and the RS232 receive operations to be completed. The smallest sample time depends on the following: <ul style="list-style-type: none"><li>• Amount of data being sent</li><li>• Amount of data being received</li><li>• Selected baud rate</li><li>• Response time of the external device</li></ul> |

### RS-232 Send Block (Asynchronous)

The Block Parameters dialog box for the Asynchronous Send block contains the following fields:

| Parameter                  | Description                                                                                                                                                                                                             |
|----------------------------|-------------------------------------------------------------------------------------------------------------------------------------------------------------------------------------------------------------------------|
| <b>Port</b>                | This list allows you to define which COM port is used for sending data. The model must contain one RS232 Setup block to configure its COM port. Otherwise, an error message is displayed.                               |
| <b>Message struct name</b> | Enter the name of the MATLAB structure this block uses to send messages and data to an RS-232 device. For information on creating this structure, see “Creating RS-232 Message Structures (Asynchronous)” on page 2-79. |
| <b>Sample time</b>         | This entry allows you to define the sample time of the block. Because the block does not wait until data is received from the external RS-232 device, you can set sample times to small values.                         |

### RS-232 Receive Block (Asynchronous)

The Block Parameters dialog box for the Asynchronous Receive block contains the following fields:

| Parameter   | Description                                                                                                                                                                                   |
|-------------|-----------------------------------------------------------------------------------------------------------------------------------------------------------------------------------------------|
| <b>Port</b> | This list allows you to define which COM port is used to send and receive data. The model must contain one RS232 Setup block for the same COM port. Otherwise, an error message is displayed. |

| <b>Parameter</b>           | <b>Description</b>                                                                                                                                                                                                           |
|----------------------------|------------------------------------------------------------------------------------------------------------------------------------------------------------------------------------------------------------------------------|
| <b>Message struct name</b> | Enter the name of the MATLAB structure this block uses to receive messages and data from an RS-232 device. For information on creating this structure, see “Creating RS-232 Message Structures (Asynchronous)” on page 2-79. |
| <b>Sample time</b>         | This entry allows you to define the sample time of the block. Because the block does not wait until data is received from the external RS-232 device, you can set sample times to small values.                              |

## **RS-232 MATLAB Structure Reference (Conventional)**

You do not use all message fields in all messages. For example, a message to send data would not use the message field `.RecData`, but would use the field `.SendData`. However, knowing the possible message fields is helpful when you are creating any of the message structures. This section contains the following topics:

- “RS-232 Send/Receive Message Structure (Synchronous)” on page 2-89 — Description of the message fields for the send/receive structure associated with RS-232 asynchronous mode and the RS-232 Send/Receive block
- “RS-232 Send Message Structure (Asynchronous)” on page 2-91 — Description of the message fields for the send structure associated with RS-232 synchronous mode and the RS-232 Send block
- “RS-232 Receive Message Structure (Asynchronous)” on page 2-92 — Description of the message fields for the receive structure associated with RS-232 synchronous mode and the RS-232 Receive block
- “Supported Data Types for Message Fields” on page 2-93 — List of supported data types and the format you use to indicate those types in message fields



## RS-232 Send/Receive Message Structure (Synchronous)

Below are descriptions of the possible message fields for the send /receive structures with asynchronous mode. The order of the fields does not matter. However, the field names are case sensitive.

| Message Field | Description                                                                                                                                                                                                                                                                                                                                                                                                   |
|---------------|---------------------------------------------------------------------------------------------------------------------------------------------------------------------------------------------------------------------------------------------------------------------------------------------------------------------------------------------------------------------------------------------------------------|
| SendData      | <p>Data and format sent to the RS-232 device. Default value = ''.</p> <p>Note that the SendData syntax format is the same as the C <code>printf()</code> library function. It is also very similar to the MATLAB <code>fscanf</code> method, with the exception that SendData is not vectorized.</p>                                                                                                          |
| InputPorts    | <p>Number of input ports for the driver block. Data from the input ports is sent to the RS-232 device with the message field <code>.SendData</code>. Default value = []. The highest number you enter determines the number of input ports on the driver block</p> <p>For example, the following message creates two input ports on the driver block,</p> <pre>RS232_Send_Receive(1).InputPorts= [1 2];</pre> |
| RecData       | <p>Data and format received from the RS-232 device. Default value = ''. The format of this statement is very similar to a <code>scanf</code> statement. The read data is mapped to the output ports defined in the message field <code>.OutputPorts</code>. If a negative output port is given, the data is read in, but not sent to any output port.</p>                                                     |

| <b>Message Field</b> | <b>Description</b>                                                                                                                                                                                                                                                                                                                                                                                                           |
|----------------------|------------------------------------------------------------------------------------------------------------------------------------------------------------------------------------------------------------------------------------------------------------------------------------------------------------------------------------------------------------------------------------------------------------------------------|
| OutputPorts          | <p>Number of output ports from the driver block. Data received from an RS-232 device is sent to the output ports with the message field <code>.ReceiveData</code>. Default value = <code>[]</code>. The highest number you enter determines the number of output ports on the driver block.</p> <p>For example, to use output ports 1 and 2 on the driver block, type</p> <pre>RS232_Send_Receive.OutputPorts = [1 2];</pre> |
| Timeout              | <p>Time, in seconds, the driver block waits for data to be returned. Default value = <code>0.049</code>.</p>                                                                                                                                                                                                                                                                                                                 |
| EOM                  | <p>Number of characters you use to indicate the end of a message.</p>                                                                                                                                                                                                                                                                                                                                                        |

## RS-232 Send Message Structure (Asynchronous)

Below is a description of the possible message fields for the send structure with synchronous mode. The order of the message fields does not matter. However, the field names are case sensitive.

| Message Field | Description                                                                                                                                                                                                                                                                                                                                                                                                    |
|---------------|----------------------------------------------------------------------------------------------------------------------------------------------------------------------------------------------------------------------------------------------------------------------------------------------------------------------------------------------------------------------------------------------------------------|
| SendData      | <p>Data and format sent to the RS-232 device. Default value = ''.</p> <p>Note that the SendData syntax format is the same as the C <code>printf()</code> library function. It is also very similar to the MATLAB <code>fscanf</code> method, with the exception that SendData is not vectorized.</p>                                                                                                           |
| InputPorts    | <p>Number of input ports for the driver block. Data from the input ports is sent to the RS-232 device with the message field <code>.SendData</code>. Default value = []. The highest number you enter determines the number of input ports on the driver block.</p> <p>For example, the following message creates two input ports on the driver block.</p> <pre>RS232_Send_Receive(1).InputPorts= [1 2];</pre> |
| Timeout       | <p>Time, in seconds, the driver block waits for data to be returned. Default value = 0.049.</p>                                                                                                                                                                                                                                                                                                                |
| EOM           | <p>Number of characters you use to indicate the end of a message.</p>                                                                                                                                                                                                                                                                                                                                          |

### RS-232 Receive Message Structure (Asynchronous)

Below are descriptions of the possible message fields for the receive message structure with synchronous mode.

| <b>Message Fields</b> | <b>Description</b>                                                                                                                                                                                                                                                                                                                                                                         |
|-----------------------|--------------------------------------------------------------------------------------------------------------------------------------------------------------------------------------------------------------------------------------------------------------------------------------------------------------------------------------------------------------------------------------------|
| RecData               | Data and format received from the RS-232 device. Default value = ' '. The format of this statement is very similar to a scanf statement. The read data is mapped to the output ports defined in the message field .OutputPorts. If a negative output port is given, the data is read in but not sent to any output port.                                                                   |
| OutputPorts           | Number of output ports from the driver block. Data received from an RS-232 device is sent to the output ports with the message field .ReceiveData. Default value = [ ]. The highest number you enter determines the number of output ports on the driver block.<br><br>For example, to use output ports 1 and 2 on the driver block,<br><pre>RS232_Send_Receive.OutputPorts = [1 2];</pre> |
| Timeout               | Time, in seconds, the driver block waits for data to be returned. Default value = 0.049.                                                                                                                                                                                                                                                                                                   |
| EOM                   | Number of characters you use to indicate the end of a message.                                                                                                                                                                                                                                                                                                                             |

## Supported Data Types for Message Fields

The following table lists the supported data types for the RS-232 message fields.

| Format    | Description                                                                        |
|-----------|------------------------------------------------------------------------------------|
| %c and %C | Single character                                                                   |
| %d or %i  | Signed decimal integer                                                             |
| %u        | Unsigned decimal integer                                                           |
| %o        | Unsigned octal integer                                                             |
| %x or %X  | Unsigned hexadecimal integer using 'abcdef' or 'ABCDEF' for the hexadecimal digits |
| %e or %E  | Exponential format using e or E                                                    |
| %f        | Floating point                                                                     |
| %g        | Signed value printed in f or e format depending on which is smaller                |
| %G        | Signed value printed in f or E format depending on which is smaller                |

## RS-232 Binary Mode (Conventional)

Use RS232 Binary Mode when you want to transfer raw data. The format of this data is either a custom format or is an image of the bytes as they are stored in memory. This section includes the following topics:

- “RS-232 Binary Mode I/O” on page 2-94 — When to use RS232 binary mode
- “RS-232 Binary Mode I/O” on page 2-94 — How to select drivers from the xPC Target block library
- “RS232 Binary Receive Block” on page 2-96 — Explanation of block parameters, inputs, and outputs
- “RS232 Binary Send Block” on page 2-97 — Explanation of Block Parameters and input

- “Example Using RS232 Binary Mode I/O” on page 2-99 — Simulink model using xPC Target driver blocks

### RS-232 Binary Mode I/O

The binary mode drivers operate in asynchronous mode. In other words, they do not wait until an entire packet of data is received, but receive as many bytes as available and then go on to the next data block. When an entire packet has been received, the block outputs the new data. Sent data is also handled similarly. The Send block instructs the RS-232 hardware to send a certain number of bytes, but does not wait for these bytes to actually be sent.

The RS-232 binary mode infrastructure also includes blocks to pack and unpack any data received. This translates the raw bytes into signals that Simulink can understand.

The functioning of these blocks is identical to the corresponding blocks in the UDP section of the xPC Target block library. The RS232 Binary Pack and Unpack blocks are actually references to these blocks. For information about UDP and the functionality of these blocks, see Chapter 6, “UDP I/O Support.”

### Using RS-232 Binary Mode

To use the RS-232 binary mode blocks, you must first insert exactly one RS232 Setup block for each COM port into your model. The setup for this block is exactly the same as it is for text-based I/O, except that initialization or termination structures are ignored. In the dialog box, set both these fields to the empty matrix ( []).

The RS-232 binary mode blocks can be found in the RS-232 section of the xPC Target Block Library. Use the following procedure to access these blocks:

- 1 In the MATLAB Command Window, type

```
xpplib
```

The xPC Target Block Library opens.

- 2 Double-click the group block **RS232**.

The **Library: xpplib/RS232** library opens.

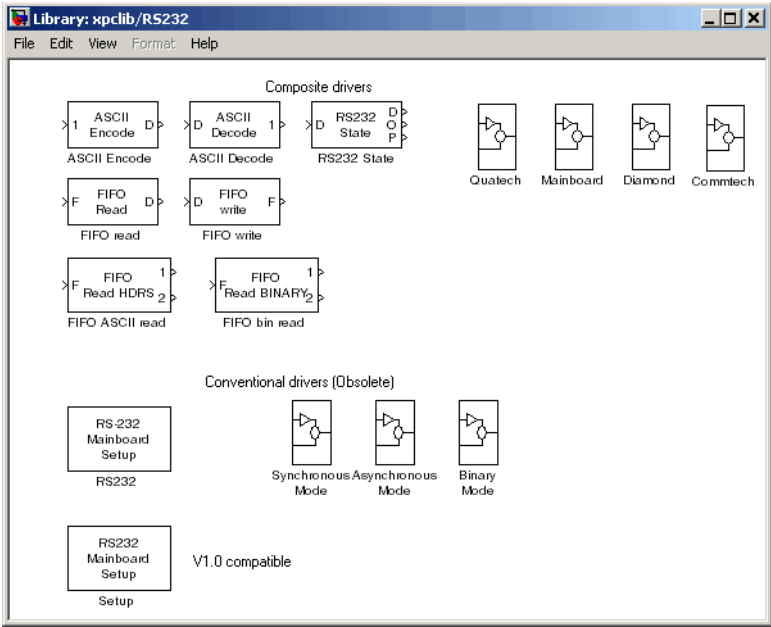

3 Double-click the group block **Binary Mode**.

The **Library: xpclib/RS232/Binary Mode** library opens.

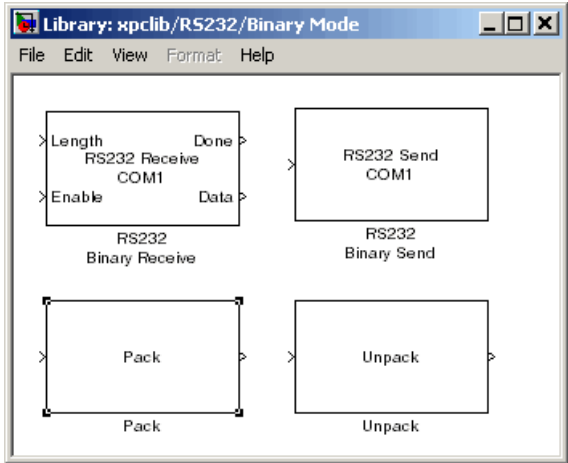

- 4 Drag and drop any of these blocks into your Simulink model.

### RS232 Binary Receive Block

The RS232 Binary Receive Block was designed with generality in mind. To this end, it supports reception of variable-length packets. A packet can be split between two different RS232 Binary Receive blocks, say for a fixed-length header followed by a variable-length body. However, the maximum possible length of a packet has to be specified in the block, and the output from the block is a vector whose width is equal to this maximum length.

If you drop a block into your model and double-click it, a Block Parameters dialog box opens where you can modify the parameters for this block.

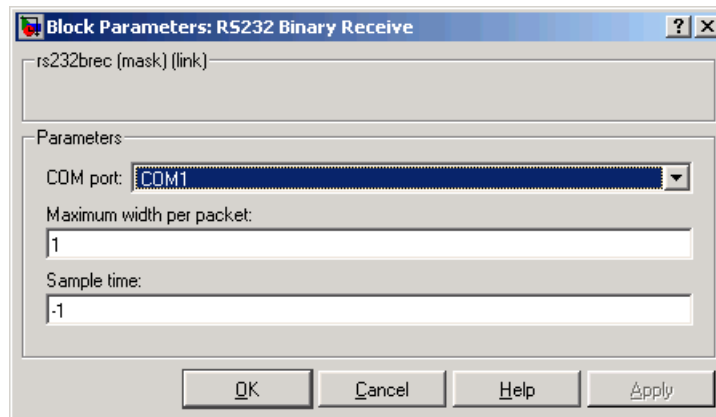

#### Block Parameters.

**COM Port** — From the list, select COM1, COM2, COM3, or COM4. This is the RS-232 port you want to receive data from. An RS232 Setup block must also exist for the same COM port in your model.

**Maximum width per packet** — Enter a value that Simulink and Real-Time Workshop use to allocate memory for the received data. This is also the width of the data output. In case the actual data is less wide than the maximum, the first few bytes of the output vector are the real data and the remaining bytes are undefined.



**Sample time** — Specifies how often the block is to be executed. In the example dialog box shown above, the setting of -1 specifies an inherited sample time, either from the base sample time of the model or from the block that the output of this block goes to.

**Block Inputs.** The RS232 Binary Receive Block has two input ports:

- **First input port** — This port is labeled `Length`, and is the size of the packet it will receive. This value should be less than or equal to the `Maximum width per packet length` parameter. The effect of changing the `Length` input during reception of one packet is undefined.
- **Second input port** — This port is labeled `Enable`, and turns the block on or off. If the `Enable` input is nonzero, the block attempts to receive data, otherwise it simply does nothing.

**Block Outputs.** The RS232 Binary Receive block has two output ports:

- **First output port** — This port is labeled `Done`, and is a function call output. This output issues a function call as soon as the block has completed receiving one packet. This can be used to drive a function call subsystem to switch. For example, to switch from a “header-receive” block to a “body-receive” block.
- **Second output port** — This port is labeled `Data`, and is the data output port. The data is a vector of `uint8s`, and is a vector of width equal to that specified in the `Maximum width per packet` parameter. If the `Length` input is less than this width, the first number of bytes equal to `Length` are the real data and the rest is garbage.

## RS232 Binary Send Block

If you drop a block into your model and double-click it, a Block Parameters dialog box opens where you can modify the parameters for this block.

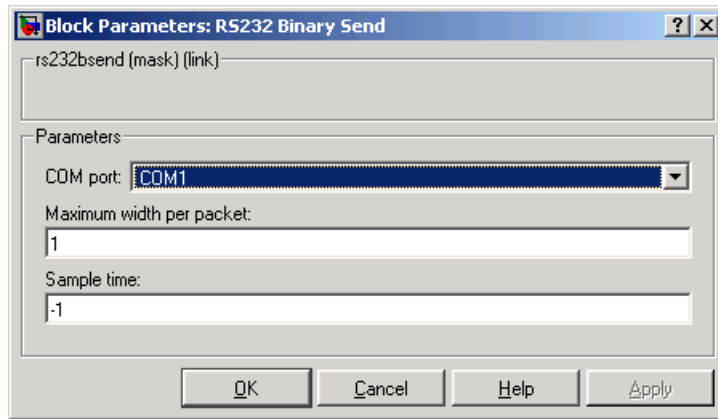

**Block Parameters. COM Port** — From the list, select COM1, COM2, COM3, or COM4. This is the port you want to use to send the data.

**Maximum width per packet** — Enter the width of the incoming data. This value is a constant, unlike the Receive block.

**Sample time** — Enter the frequency this data is sent.

### Block Input

**Input Port** — This port represents the data to be transmitted. The data should be a vector of type `uint8` and of a **Packet width** specified in the dialog box.

### RS232 Binary Pack Block

Same as UDP Pack block. See “UDP Pack Block” on page 6-9.

### RS232 Binary Unpack Block

Same as UDP Unpack block. See “UDP Unpack Block” on page 6-10.

## Example Using RS232 Binary Mode I/O

To show the flexibility provided by the RS232 Binary Receive block, the following illustrates how this block can be used. The model that implements this setup is provided with xPC Target. To access this model, type

```
xpcrs232bindemo
```

at the command prompt. This opens the model, which is essentially self-documenting. Open each subsystem in the model to see what that part is supposed to accomplish.

Here is an example of a messaging protocol that the model has to conform to.

The protocol consists of a one-byte header, followed by a variable-length body. The header can have only two legal values, 12 and 17. If the header is 12, the body is 6 bytes long, and consists of a `uint16` followed by an `int32` (in terms of MATLAB data types). If the header is 17, the body is 4 bytes long, and consists of a `uint16` followed by an `int16`.

The model receives one header byte at a time, rejecting any invalid ones. As soon as a valid header byte is received, the execution switches to the body block, where the proper number of bytes is received. The data is then appropriately decoded and displayed on an xPC Target Scope of type target. The model should serve as an example of how this is done.

The basic algorithm is to receive a header byte and then compare it to the list of known headers (12 and 17). The body length is set appropriately depending on the header, and the “Done” function-call output of the header block is used to trigger functioning of the body block (via the “distributor” function call subsystem).



# GPIB I/O Support

---

xPC Target interfaces the target PC to a GPIB instrument bus using an external GPIB controller from National Instruments. This external controller is connected to the target PC with a serial cable. This chapter includes the following sections:

|                                           |                                                                                                                            |
|-------------------------------------------|----------------------------------------------------------------------------------------------------------------------------|
| Introduction to GPIB Drivers (p. 3-2)     | Description of hardware connections, Simulink blocks, and MATLAB message structures associated with the Simulink blocks    |
| Using GPIB Drivers (p. 3-5)               | Procedures to add GPIB driver blocks to your Simulink model and create the message structures associated with those blocks |
| GPIB Simulink Block Reference (p. 3-13)   | Description of block parameters for GPIB driver blocks                                                                     |
| GPIB MATLAB Structure Reference (p. 3-16) | Description of the fields in the message structures, shortcuts, and data types supported in the message fields             |

## Introduction to GPIB Drivers

xPC Target uses a model for I/O that includes both Simulink blocks, for the I/O drivers, and MATLAB structures for sequencing messages and commands. This model provides increased flexibility and control over using only Simulink blocks in your model. The topics in this section are

- “Hardware Connections for GPIB” on page 3-2 — Connect the target PC to a GPIB-232CT-A controller from National Instruments.
- “Simulink Blocks for GPIB” on page 3-3 — Add setup, send, and receive blocks to your Simulink model.
- “MATLAB Message Structures for GPIB” on page 3-3 — Create message structures to sequence instructions to and from the GPIB controller.

## Hardware Connections for GPIB

xPC Target supports connecting to a GPIB instrument bus with a GPIB-232CT-A controller from National Instruments.

One end of the controller is connected to either the COM1 or COM2 port on the target PC with a null modem cable. The other end is connected to the GPIB instrument bus with a standard GPIB connector and cable.

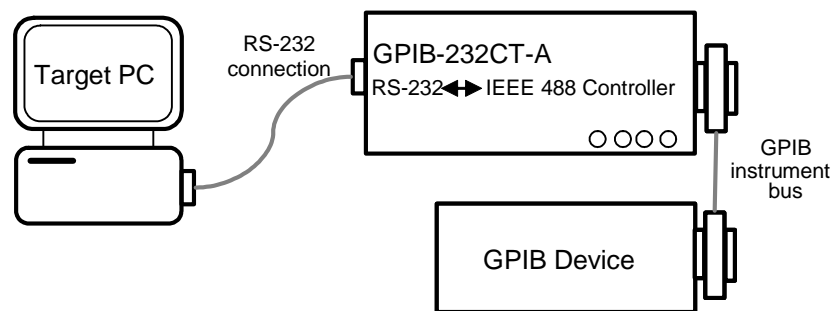

## Simulink Blocks for GPIB

To support the use of GPIB, the xPC Target I/O library includes a set of GPIB driver blocks. These driver blocks can be added to your Simulink model to provide inputs and outputs to devices on a GPIB instrument bus.

- **GPIB Setup** — One setup block is needed for each GPIB controller. The setup block does not have any inputs or outputs, but sends the initialization and termination messages.
- **GPIB Send/Receive** — The send/receive block has inputs and outputs from your Simulink model, and sequences both the send and receive messages.

## MATLAB Message Structures for GPIB

Communication is through a series of messages passed back and forth between the target PC and the GPIB controller. To accomplish this, the messages sent to the GPIB controller must be in a format that the controller understands. Likewise, the target PC must know how to interpret the data returned from the GPIB controller.

xPC Target uses MATLAB structures to create messages and map the input and output ports on the GPIB driver blocks to the data written and read from the GPIB devices. The GPIB Setup block executes the messages in the initialization structure after downloading the target application. The GPIB Send/Receive block repeats the execution of the messages in the send/receive structure during each sample interval. When the target application stops running, the GPIB Setup block executes the messages in the termination structure.

Below is an example of a send/receive message structure. The first message writes a command to instruct the GPIB device to acquire a single data value, while the second message sends a command to read that value and output the result to the output port line coming from a GPIB driver block.

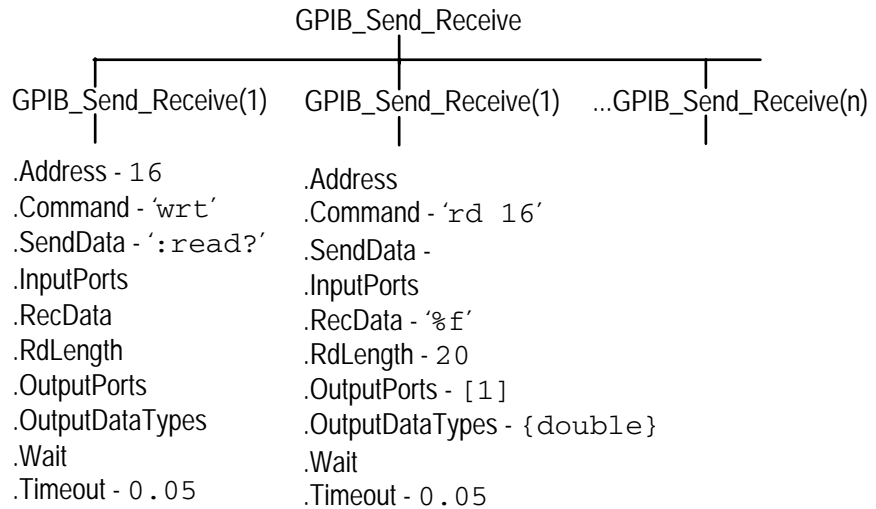

Currently, only two limitations exist. xPC Target does not support string data types as input and output data types. Also, you must know the size and order of data returned from a read command.

For more information on this example, see “Creating GPIB Message Structures” on page 3-10.



## Using GPIB Drivers

xPC Target uses a combination of Simulink blocks and MATLAB structures to support GPIB communication from your target application and target PC. The topics in this section are

- “Adding GPIB Driver Blocks” on page 3-5 — Add the setup and send/receive blocks you need to add to your Simulink model for GPIB communication.
- “Creating GPIB Message Structures” on page 3-10 — Create the initialize, send/receive, and termination message structures you need in the MATLAB workspace.

This section uses an example of a multimeter attached to a GPIB bus with an address of 16. This multimeter needs the initialization command

```
:conf:volt:dc
```

to set the device to read DC voltages, and needs the command

```
:read?
```

during each sample interval to read one voltage value

### Adding GPIB Driver Blocks

The GPIB driver blocks initialize and communicate directly with the GPIB controller. The GPIB controller then communicates with the GPIB devices on the instrument bus.

After you create a Simulink model, you can add GPIB driver blocks and define the initialization, send/receive, and termination message structures.

- 1 In the MATLAB Command Window, type

```
xpclib
```

The xPC Target driver block library opens.

- 2 Double-click the GPIB group block.

A manufacturers window opens. Currently xPC target only supports GPIB communication with a National Instruments controller.

- 3 Double-click the National Instruments group block.

A window with blocks for GPIB drivers opens.



Alternatively, you could access the xPC Target block library from the Simulink Library Browser. In the Simulink window, and from the **View** menu, click **Show Library Browser**. In the left pane, double-click **xPC Target**, double-click **GPIB**, and then click **National Instruments**.

- 4 Drag and drop a GPIB Setup block and a GPIB Send/Receive block to your Simulink model.

Your model should look similar to the figure below. Note that the input and output ports are not defined or visible on the blocks. The inputs and outputs are defined in a MATLAB message structure, and are visible only after you load that structure into the MATLAB workspace and update your Simulink model.

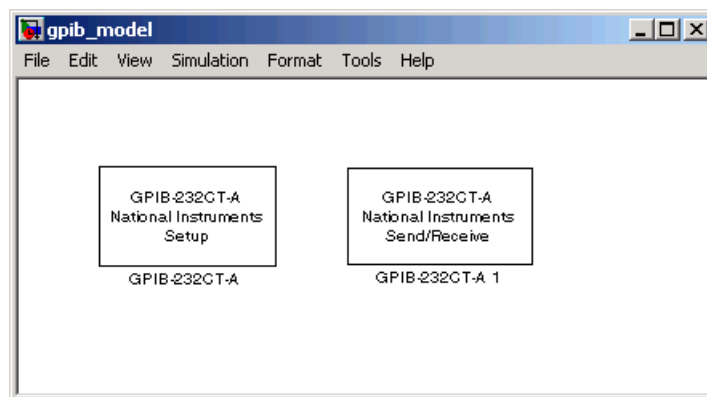

- 5 Double-click the GPIB Setup block. Enter values that correspond to the DIP switch settings you set on the GPIB-232CT-A controller. In the **Initialization Struct** box, enter the name for the MATLAB structure this block uses to send initialization messages to the GPIB device.

**Note** If you are not using an initialization or termination structure, enter two single quotes.

For example, if the target PC is connected to COM1, and you set the switches on the controller to 38400 baud, 8 data bits, and 1 stop bit, your Block Parameter dialog box should look similar to the figure shown below.

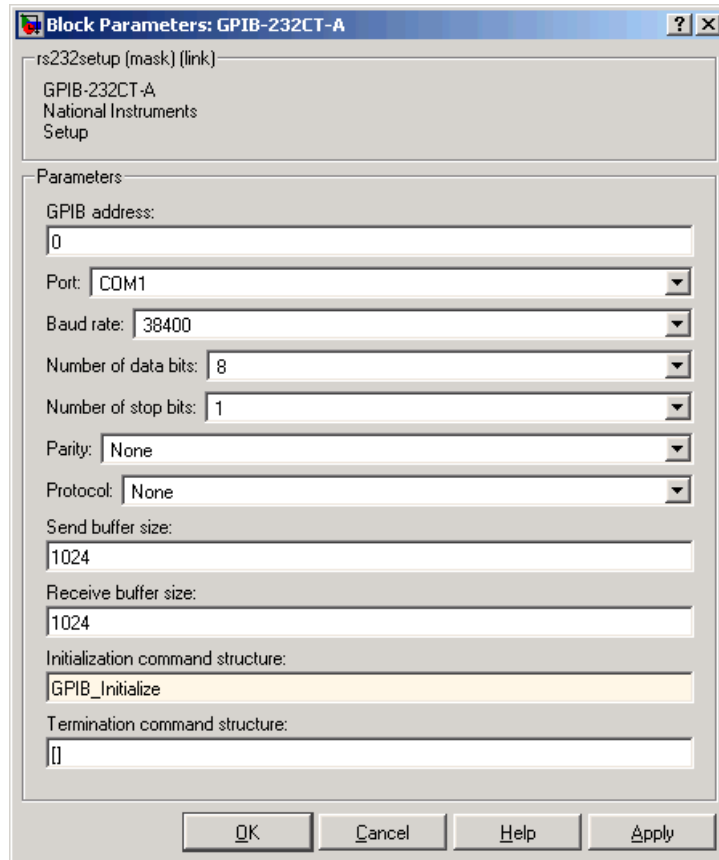

For more information on entering the block parameters, see “PC-DIO-24” on page 22-8. For the procedure to create the initialization structure, see “Creating GPIB Message Structures” on page 3-10.

- 6 Click **OK**. The Block Parameters dialog box closes.
- 7 Double-click the GPIB Send/Receive block. The Block Parameters dialog box opens.

- From the **Port** list, select either COM1 or COM2. This is the port on the target PC connected to the GPIB controller. In the **Message Struct Name** box, enter the name for the MATLAB structure this block uses to send and receive messages to the GPIB device. In the **Sample Time** box, enter the same sample time or multiple of the sample time you entered for the fixed step size in the Simulation -> Configuration Parameters dialog box **Solver** pane.

Your Block Parameter dialog box should look similar to the figure shown below.

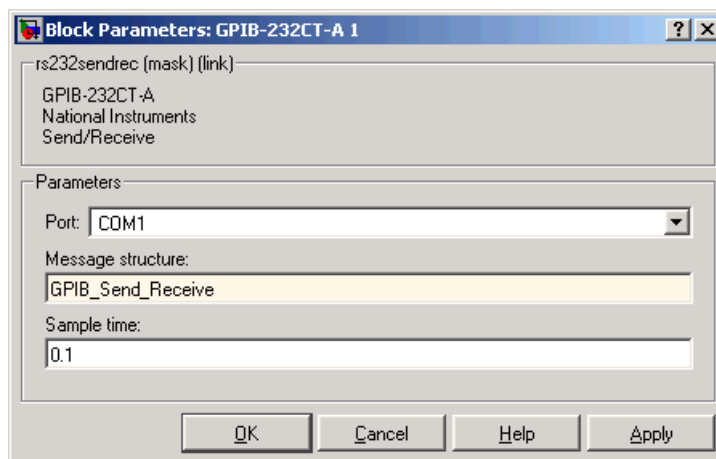

For more information on entering the block parameters, see “PC-DIO-24” on page 22-8.

- Click **OK**. The Block Parameters dialog box closes.

Your next task is to create the MATLAB message structures that the GPIB driver blocks use to sequence commands to the GPIB controller. See “Creating GPIB Message Structures” on page 3-10.

## Creating GPIB Message Structures

GPIB drivers use MATLAB structures to send and receive messages and to map the input and output ports on the GPIB driver blocks to the data written and read from the GPIB devices.

After you add GPIB driver blocks to your Simulink model, you can create the message structures to communicate with the GPIB controller. You need to create and load these structures into the MATLAB workspace before you build your target application. The easiest way to create these structures is to create an M-file and load that M-file into the MATLAB workspace.

- 1 In the MATLAB Command Window, and from the **File** menu, point to **New**, and then click **M-file**.

A MATLAB text editor window opens.

- 2 Enter the initialization and send/receive messages. Each message is an element in a MATLAB structure array with a series of fields. For information and examples of these fields, see “GPIB Initialization and Termination Message Structures” on page 3-17 and “GPIB Send/Receive Message Structure” on page 3-18.

As an example, if you have a multimeter attached to a GPIB bus that has an address of 16, needs the initialization command `:conf:volt:dc` to set the device to read DC voltages, and uses the command `:read?` to read one voltage value, you could type the following:

**Note** Field names in the structures are case sensitive.

```
GPIB_Initialize(1).Command = 'wrt 16';  
GPIB_Initialize(1).SendData = ':conf:volt:dc';
```

```
GPIB_Send_Receive(1).Address= 16;  
GPIB_Send_Receive(1).Command = 'wrt 16';  
GPIB_Send_Receive(1).SendData = ':read?';  
GPIB_Send_Receive(1).Timeout = 0.05;
```

```
GPIB_Send_Receive(2).Command = 'rd 16';  
GPIB_Send_Receive(2).RecData = '%f';  
GPIB_Send_Receive(2).RdLength = 20;  
GPIB_Send_Receive(2).OutputPorts = [1];
```

```
GPIB_Send_Receive(2).OutputDataTypes = {'double'};  
GPIB_Send_Receive(2).Timeout = 0.15;
```

This example did not need a termination structure. But if it did, the format of the structure is the same as the initialization structure. For example, a termination structure could have a message with the `.Command` and `.SendData` fields.

```
GPIB_Termination(1).Command  
GPIB_Termination(1).SendData
```

- 3** From the **File** menu, click **Save As**. In the Save As File dialog box, enter the name of the M-file. For example, enter

```
GPIB_Messages.m
```

- 4** Close the text editing window.

- 5** In the MATLAB Command Window, type the name of the M-file you created with the GPIB structures. For example, type

```
GPIB_Messages
```

MATLAB loads and runs the M-file to create the message structures in the MATLAB workspace needed by the GPIB driver blocks.

- 6** Open your Simulink model, or press **Ctrl+D**.

The GPIB driver blocks are updated with the information from the structures. For example, inputs and outputs defined in the structures are now visible on the driver blocks.

Your model should look similar to the figure shown below.

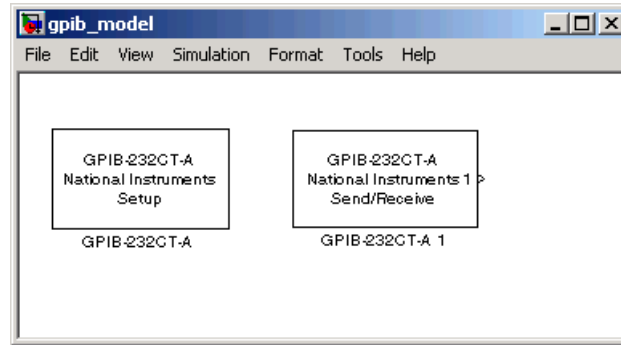

- 7 Set the `PreLoadFcn` for your Simulink model to load the message structures when you open the model. For example, if you saved the message structures in the M-file `GPIB_messages`, type

```
set_param(gcs, 'PreLoadFcn', 'GPIB_messages.m')
```

**Note** If you do not manually load the message structures before opening your Simulink model, or have the message structures automatically loaded with the model, the port connections to the GPIB driver blocks break.

Your next task is to build the target application and download it to the target PC.



## GPIB Simulink Block Reference

The GPIB-232CT-A is a GPIB controller external to the target PC. It is connected to the target PC with an RS-232 cable.

xPC Target supports this controller with two driver blocks:

- “GPIB-232CT-A Setup Block” on page 3-13
- “GPIB-232CT-A Send/Receive Block” on page 3-15

### Board Characteristics

|                                 |                      |
|---------------------------------|----------------------|
| Board name                      | GPIB-232CT-A         |
| Manufacturer                    | National Instruments |
| Bus type                        | N/A                  |
| Access method                   | RS232                |
| Multiple block instance support | No                   |
| Multiple board support          | Yes                  |

### GPIB-232CT-A Setup Block

The setup block parameters must be set to match the jumper settings on the GPIB-232CT-A controller.

### Driver Block Parameters

| Parameter           | Description                                                                                                                                        |
|---------------------|----------------------------------------------------------------------------------------------------------------------------------------------------|
| <b>GPIB address</b> | Enter the identification number for the GPIB controller. When the GPIB-232CT-A is turned on, the identification number is set to 0.                |
| <b>Port</b>         | From the list, select COM1, COM2, COM3, or COM4. This is the serial connection the target PC uses to communicate with the GPIB-232CT-A controller. |

| <b>Parameter</b>                     | <b>Description</b>                                                                                                                                                                                                                                                                                                                                              |
|--------------------------------------|-----------------------------------------------------------------------------------------------------------------------------------------------------------------------------------------------------------------------------------------------------------------------------------------------------------------------------------------------------------------|
| <b>Baud rate</b>                     | From the list, select 115200, 57600, 38400, 19200, 9600, 4800, 2400, 1200, 600, or 300.                                                                                                                                                                                                                                                                         |
| <b>Number of data bits</b>           | From the list, select 8 or 7.                                                                                                                                                                                                                                                                                                                                   |
| <b>Number of stop bits</b>           | From the list, select 1 or 2.                                                                                                                                                                                                                                                                                                                                   |
| <b>Parity</b>                        | From the list, select None, Odd, or Even.                                                                                                                                                                                                                                                                                                                       |
| <b>Protocol</b>                      | From the list, select None or X0n/X0ff. If your serial device does not support hardware handshaking, or your application software requires X0n/X0ff handshaking, you might need to select X0n/X0ff.                                                                                                                                                             |
| <b>Send buffer size</b>              | Enter the buffer size in bytes.                                                                                                                                                                                                                                                                                                                                 |
| <b>Receive buffer size</b>           | Enter the buffer size in bytes.                                                                                                                                                                                                                                                                                                                                 |
| <b>Initialization command struct</b> | <p>Enter the name of the structure containing the initialization information. For example, enter</p> <p style="text-align: center;"><code>GPIB_Initialize</code></p> <p>If you are not using initialization messages, enter two single quotes in this box. For information on creating this structure, see “Creating GPIB Message Structures” on page 3-10.</p> |
| <b>Termination command struct</b>    | Enter the name of the structure containing the termination information.                                                                                                                                                                                                                                                                                         |

## GPIB-232CT-A Send/Receive Block

### Driver Block Parameters

| Parameter                | Description                                                                                                                                                                       |
|--------------------------|-----------------------------------------------------------------------------------------------------------------------------------------------------------------------------------|
| <b>Port</b>              | From the list, select COM1, COM2, COM3, or COM4. This is the serial connection the target PC uses to send and receive data with the GPIB-232CT-A controller.                      |
| <b>Message structure</b> | Enter the name of the MATLAB structure containing the messages to be sent to the GPIB controller.                                                                                 |
| <b>Sample time</b>       | Enter the base sample time or a multiple of the base sample time you entered for the fixed step size in the Simulation -> Configuration Parameters dialog box <b>Solver</b> pane. |

## **GPIB MATLAB Structure Reference**

You do not use all message fields in all messages. For example, a message to send data would not use the message field `.RecData`, but would use the field `.SendData`. However, knowing the possible message fields is helpful when you are creating any of the message structures.

This section includes the following topics:

- “GPIB Initialization and Termination Message Structures” on page 3-17 — Description of the message fields for the initialization and termination structures associated with the GPIB Setup block
- “GPIB Send/Receive Message Structure” on page 3-18 — Description of the message fields for the send/receive structure associated the GPIB Send/Receive block
- “Shortcuts and Features for Messages” on page 3-21 — Shortcuts to using the GPIB `wrt` and `rd` commands
- “Supported Data Types for Message Fields” on page 3-23 — List of supported data types and the format you use to indicate those types in message fields

## GPIB Initialization and Termination Message Structures

The formats for the initialization and termination structures are similar to the send/receive structure except for a few differences:

The initialization and termination structures do not need to receive or send information through driver block ports on your Simulink model. Therefore, the initialization and termination structures do not use the message fields `.InputPorts`, `.OutputPorts`, `.RecData`, and `.OutputDataTypes`.

Below is a description of the possible message fields for the initialization and termination structures. The order of the message fields does not matter. However, the field names are case sensitive.

| <b>Message Fields</b> | <b>Description</b>                                                                                                                                                                                                                  |
|-----------------------|-------------------------------------------------------------------------------------------------------------------------------------------------------------------------------------------------------------------------------------|
| Address               | Sets the GPIB address for the device being accessed and defines the keyword ADDR. Default value = [ ].                                                                                                                              |
| Command               | GPIB command sent to a GPIB device. Default value = ''.                                                                                                                                                                             |
| SendData              | Data sent with the GPIB command. Default value = ''.                                                                                                                                                                                |
| RdLength              | Defines the length of the acknowledge string, in bytes, from the GPIB controller.                                                                                                                                                   |
| Ack                   | The expected acknowledgment string from the controller as a result of an initialization or termination message. If this value is set, you need to set the time-out value. If no string is defined, then no acknowledge is expected. |
| Timeout               | Time, in seconds, allowed for the GPIB controller to respond to a message and send back an acknowledge string. Default value = 0.049 seconds.<br><br>If the time-out value is exceeded, a time-out error is reported.               |

## GPIB Send/Receive Message Structure

Below is a description of the possible fields for the send/receive message structure. The order of the message fields in a message does not matter. However, the field names are case sensitive.

| Message Fields | Description                                                                                                                                                                                                                                                                                                                                                                                                                                                                                                                                                                                                    |
|----------------|----------------------------------------------------------------------------------------------------------------------------------------------------------------------------------------------------------------------------------------------------------------------------------------------------------------------------------------------------------------------------------------------------------------------------------------------------------------------------------------------------------------------------------------------------------------------------------------------------------------|
| Address        | <p>Sets the GPIB address for the device being accessed. After the GPIB address is set, the remaining messages use this address value until another message changes the address value. Default value = 0.</p> <p>The keyword ADDR is equal to the value in the message field .Address. You can use this keyword in the message fields .Command or .SendData to replace the numerical value of the GPIB address. For example, you can write</p> <pre>GPIB_Send_Receive(1).Command='wrt 16';</pre> <p>Or you can write</p> <pre>GPIB_Send_Receive(1).Address = 16; GPIB_Send_Receive(1).Command='wrt ADDR';</pre> |
| Command        | GPIB command sent to a GPIB device. Default value = ''.                                                                                                                                                                                                                                                                                                                                                                                                                                                                                                                                                        |
| SendData       | Data sent with the GPIB command. Default value = ''.                                                                                                                                                                                                                                                                                                                                                                                                                                                                                                                                                           |
| InputPorts     | <p>Defines the input ports for the driver block. Data from the input ports is sent to the GPIB device with the message fields .Command and .SendData. Default value = []. The highest number you enter determines the number of input ports on the driver block.</p> <p>For example, the following message creates two input ports on the driver block, and passes data from the input ports to the read command.</p> <pre>GPIB_Send_Receive(1).Command = 'rd #%d %d'; GPIB_Send_Receive(1).InputPorts= [1 2];</pre>                                                                                           |

| <b>Message Fields</b> | <b>Description</b>                                                                                                                                                                                                                                                                                                                                                                                                                                                                                                                                                                                                                                                          |
|-----------------------|-----------------------------------------------------------------------------------------------------------------------------------------------------------------------------------------------------------------------------------------------------------------------------------------------------------------------------------------------------------------------------------------------------------------------------------------------------------------------------------------------------------------------------------------------------------------------------------------------------------------------------------------------------------------------------|
|                       | <p>The first port is used to dynamically provide the length of the receive string, while the second port provides the value of the GPIB device.</p>                                                                                                                                                                                                                                                                                                                                                                                                                                                                                                                         |
| <p>RecData</p>        | <p>Format of the data received from the GPIB device. Default value = ' '. The format of this statement is very similar to a scanf statement. The read data is mapped to the output ports defined in the field .OutputPorts. If a negative output port is given, the data is read in, but not sent to any output port.</p> <p>For example, to read from a GPIB device with an address of 16, one floating-point number with a maximum number of bytes of 20, and send the data to the first driver block output, type the following:</p> <pre>GPIB_Send_Receive(1).Command = 'rd #20 16'; GPIB_Send_Receive(1).RecData = '%f'; GPIB_Send_Receive(1).OutputPorts = [1];</pre> |
| <p>RdLength</p>       | <p>Defines the length of the data, in bytes, received with the read command and defines the keyword LENGTH. Default value = 0.</p>                                                                                                                                                                                                                                                                                                                                                                                                                                                                                                                                          |
| <p>OutputPorts</p>    | <p>Defines the output ports from the driver block. Data received from a GPIB device with the read command is sent to the output ports. Default value = [ ]. The highest number you enter determines the number of output ports on the driver block.</p> <p>For example, to use output ports 1 and 2 on the driver block, type</p> <pre>GPIB_Send_Receive.OutputPorts = [1 2];</pre>                                                                                                                                                                                                                                                                                         |

| <b>Message Fields</b> | <b>Description</b>                                                                                                                                                                                                                                                                                                                          |
|-----------------------|---------------------------------------------------------------------------------------------------------------------------------------------------------------------------------------------------------------------------------------------------------------------------------------------------------------------------------------------|
| OutputData Types      | <p>Defines the data types for the output ports on the driver block. Default value = [ ].</p> <p>If this value is not defined, and there are output ports, the default type is <code>double</code>. Also, if there are more output ports than output data types listed, the default type for the undefined ports is <code>double</code>.</p> |
| Wait                  | <p>The amount of time, in seconds, to wait before executing the next message. This value is limited to 50 milliseconds. Default value = 0.</p>                                                                                                                                                                                              |
| Timeout               | <p>Time, in seconds, the driver block waits for data to be returned. Default value = 0.049.</p>                                                                                                                                                                                                                                             |



## Shortcuts and Features for Messages

xPC Target defines the abbreviations `wrt` and `rd` to make message writing with GPIB commands easier. When the message interpreter sees the statements

- `Structure_name(index) . 'wrt'`, it is replaced with `Structure_name(index) . 'wrt ADDR'`. For example, you could write `GPIB_Initialize(1).Command = 'wrt 8'`;

or you could write

```
GPIB_Initialize(1).Address = 8;
GPIB_Initialize(1).Command = 'wrt';
```

The following message fields, with the keyword `ADDR`, use the address value 8 defined in the message field `.Address`.

- `Structure_name (index).Command = 'rd'`, it is replaced with `Structure_name(index).Command = 'rd #LENGTH ADDR'`. For example, you could write

```
GPIB_Initialize(1).Command = 'rd #10 8';
```

or you could write

```
GPIB_Initialize(1).Address = 8;
GPIB_Initialize(1).RdLength = 10
GPIB_Initialize(1).Command = 'wrt';
```

If you enter numerical values in the `wrt` and `rd` commands, then the command uses those values instead of the values in the variables `ADDR` and `LENGH`. For example, the following message uses the GPIB address 10 even though the value for `ADDR` is defined as 8.

```
GPIB_Initialize(1).Address = 8;
GPIB_Initialize(1).Command = 'wrt 10';
```

**Changes to the Read Command** — When a GPIB `rd` command is sent to the GPIB controller, the controller responds with the data and length of data. To make using this command easier, the xPC Target driver block discards the length of data information. For example, using the normal GPIB `rd` command, you could write

```
GPIB_Message(1).Command = 'rd #20 16';
GPIB_Message(1).RecData = '%f%d';
```

```
GPIB_Message(1).OutputPorts = [1 -1];
```

The code %d reads the length of data and the -1 discards the length. Using the modified xPC Target rd command, you would write

```
GPIB_message(1).Command = 'rd #20 16';  
GPIB_message(1).RecData = '%f';  
GPIB_message(1).OutputPorts = [1];
```

**Automatic Addition of Escape Characters** — The message interpreter automatically places the correct escape characters at the end of the message fields .Command, .SendData, and .Ack. However, if you add the escape characters, then the message interpreter does not add additional characters.

The escape characters are \\, \a, \b, \f, \r, \t, \v, \', \', and \n.

For example, you can write

```
GPIB_Message.Command = 'wrt 16\n';  
GPIB_Message.SendData = ':conf:volt:dc\r';  
GPIB_Message.Ack = '10\n\r';
```

or you can write the following, and the appropriate escape characters are added.

```
GPIB_Message.Command = 'wrt 16';  
GPIB_Message.SendData = ':conf:volt:dc';  
GPIB_Message.Ack = '10';
```

## Supported Data Types for Message Fields

The following table lists the supported data types for the message fields `.SendData` and `.Recdata`:

| Format                              | Description                                                                         |
|-------------------------------------|-------------------------------------------------------------------------------------|
| <code>%c</code> and <code>%C</code> | Single character and wide character                                                 |
| <code>%d</code> or <code>%I</code>  | Signed decimal integer                                                              |
| <code>%u</code>                     | Unsigned decimal integer                                                            |
| <code>%o</code>                     | Unsigned octal integer                                                              |
| <code>%x</code> or <code>%X</code>  | Unsigned hexadecimal integer using 'abcdef' or 'ABCDEF' for the hexadecimal digits. |
| <code>%e</code> or <code>%E</code>  | Exponential format using e or E                                                     |
| <code>%f</code>                     | Floating point                                                                      |
| <code>%g</code>                     | Signed value printed in f or e format depending on which is smaller                 |
| <code>%G</code>                     | Signed value printed in f or E format depending on which is smaller                 |



# CAN I/O Support

---

This chapter includes the following sections:

Introduction (p. 4-3)

xPC Target offers support to connect a target PC to a CAN network using the CAN driver blocks provided by the xPC Target I/O block library. This support is for I/O device drivers for the CAN-AC2-ISA and CAN-AC2-PCI boards from Softing GmbH (Germany).

CAN Driver Blocks for the CAN-AC2 (ISA) with Philips PCA 82C200 CAN Controller (p. 4-7)

The driver blocks described here support the CAN-AC2 (ISA) without piggyback modules.

CAN Driver Blocks for the CAN-AC2 (ISA) with Intel 82527 CAN Controller (p. 4-14)

The driver blocks described here support the CAN-AC2 (ISA) with piggyback modules.

CAN Driver Blocks for the CAN-AC2-PCI with Philips SJA1000 CAN Controller (p. 4-22)

The driver blocks described here support the CAN-AC2-PCI.

CAN Driver Blocks for the CAN-AC2-104 (PC/104) with Philips SJA1000 CAN Controller (p. 4-30)

The driver blocks described here support the CAN-AC2-104 (PC/104).

Constructing and Extracting CAN Data Frames (p. 4-38)

CAN data frames have a maximum size of 8 bytes (64 bits). For the CAN driver blocks found in the xPC Target I/O block library, Simulink signals of data type double are used to propagate data frames as an entity.

Detecting Time-Outs When Receiving CAN Messages (p. 4-47)

The Receive driver blocks for all CAN boards allow you to output the timestamp at which the latest corresponding CAN message has been received.

Model Execution Driven by CAN Messages (Interrupt Capability of CAN Receive Blocks) (p. 4-49)

In certain applications, the model (target application) execution is driven by the pace of an incoming CAN message.

Defining Initialization and Termination CAN Messages (p. 4-53)

The CAN Setup driver blocks for all supported CAN boards allow the definition of CAN messages to be sent out during initialization and termination of the target application.

CAN-AC2 and CANopen Devices (p. 4-55)

xPC Target CAN-AC2 supports CAN specification 2.0a and 2.0b but this does not generally include the CANopen protocol on driver level. Nevertheless it is possible to access CANopen devices by the CAN-AC2 drivers in a general way.

## Introduction

xPC Target offers support to connect a target PC to a CAN network using the CAN driver blocks provided by the xPC Target I/O block library. This support is for I/O device drivers for the CAN-AC2-ISA and CAN-AC2-PCI boards from Softing GmbH (Germany). The CAN driver library allows xPC Target applications to connect to any CAN field bus network for I/O communication or real-time target-to-target communication. This topics in this section are

- “xPC Target CAN Library” on page 4-3
- “CAN-AC2” on page 4-5
- “CAN-AC2-PCI” on page 4-6
- “CAN-AC2-104” on page 4-6

### xPC Target CAN Library

The drivers support CAN specifications 2.0A and 2.0B and use the dynamic object mode of the CAN-AC2 firmware to achieve maximum real-time performance.

The library supports the following CAN boards from Softing GmbH, Germany.

| Board Name  | Form Factor | Identifier Range                            | Multiple Board Support |
|-------------|-------------|---------------------------------------------|------------------------|
| CAN-AC2     | ISA         | Standard (& Extended with piggyback module) | No                     |
| CAN-AC2-PCI | PCI         | Standard & Extended                         | Yes (up to 3)          |
| CAN-AC2-104 | PC/104      | Standard & Extended                         | Yes (up to 3)          |

For more information on the board specifications, visit <http://www.softing.com>.

The xPC Target CAN library intentionally restricts its support to Softing boards with two CAN ports (boards with one channel would be available as well). This is because the two-port versions allow you to check the correct functioning of the board and drivers by just connecting the first CAN port to the second CAN port. This forms a loop-back without you needing to connect the board to a “real” CAN-network. The `xpcdemos` directory contains simple loop-back test models to test the ISA, PCI, and PC/104 boards. Type the following commands to open the corresponding test models.

| <b>Model Name (Command)</b> | <b>Board</b> |
|-----------------------------|--------------|
| <code>xpccanisa</code>      | CAN-AC2      |
| <code>xpccanpci</code>      | CAN-AC2-PCI  |
| <code>xpccanpc104</code>    | CAN-AC2-104  |

The size of the driver code of the CAN boards supported by the xPC Target block library is significant, and because not all xPC Target applications will use CAN, the CAN library code is not linked by default when building a target application. This makes target applications smaller if no CAN communication functionality is needed. If the model to be built contains CAN driver blocks, xPC Target links in the appropriate CAN library code when necessary.

For each CAN board three driver blocks are provided:

- A setup block, which defines the type of physical connection (baud rate and so forth). Exactly one instance of the setup block must be defined in a model for each physically installed CAN board.
- A send block, which transmits (sends) the data entering the block’s input ports to the connected CAN network. One or more instances of the Send block can be used in a model.
- A receive block, which retrieves (reads) CAN messages received by the board and outputs the data at the corresponding output ports. One or more instances of the Receive block can be used in a model.

The maximum size of the data frame of a CAN message is 8 bytes. This is the same size as the C data type `double` uses on PC-compatible systems. At the same time, the `double` data type is the default data type used for Simulink signals. Therefore the CAN data frame within a Simulink model can be easily



represented by a scalar Simulink signal even if the data frame has nothing in common with a double floating point value. The xPC Target CAN library provides a Utility sublibrary that offers bit-packing and bit-unpacking blocks. These blocks are used to pack data types other than doubles into 64 bits (8 bytes or a double) as well as for the opposite operation. This is discussed in greater detail below. What is important for now is that CAN data frames are represented by Simulink signals of data type double.

All drivers for the supported CAN boards program the boards for the so-called *dynamic object mode*. This is one of three modes the CAN board firmware from Softing can operate in. For a more detailed discussion of the three modes see the board's user manual. Dynamic object mode is best suited for real-time environments where each component of the application must have deterministic time behavior. This is the case for xPC Target, and that is the main reason why this mode has been chosen over the other two modes, which are FIFO and static object mode.

The following paragraphs summarize the differences among the three supported Softing boards.

## **CAN-AC2**

This is the CAN board for the ISA bus offering two CAN ports (highspeed). In its standard hardware configuration it uses the Philips PCA 82C200 CAN controller, which supports standard identifiers only. Piggyback modules are available (one for each port) that replace the Philips CAN controllers with Intel 82527 CAN controllers. The Intel controllers support both standard and extended identifiers. The board is a memory-mapped device and uses a 16 KB address range between 640 KB and 1 MB. We do not recommend this board for new projects; use the CAN-AC2-PCI which is described below instead. Softing plans that no new firmware versions are planned for this board.

### **CAN-AC2-PCI**

This is the CAN board for the PCI bus offering two CAN ports. The CAN controllers used on the board are the SJA1000 from Philips. In its standard hardware configuration the board is designed for both standard and extended identifiers for high-speed CAN. Piggyback modules are available (one for each port) that add low-speed CAN support to switch between high-speed and low-speed CAN. The board is a memory mapped PCI device that uses 64 KB of address space. The address space is assigned automatically by the PCI BIOS of the target PC and lies usually in the range between 2 GB and 4 GB. Any new projects where a desktop PC is used as the target system should use this board and not the ISA board described above.

### **CAN-AC2-104**

This is the CAN board for the PC/104 bus offering two CAN ports. The CAN controllers used on the board are the SJA1000 from Philips. The board offers both standard and extended identifiers for high-speed CAN. A low-speed CAN hardware extension is not available. The board is both I/O mapped and memory mapped. The I/O-mapped area uses a 3 B address range and the memory-mapped area uses a 4 KB address range between 640 KB and 1 MB.

## CAN Driver Blocks for the CAN-AC2 (ISA) with Philips PCA 82C200 CAN Controller

The driver blocks described here support the CAN-AC2 (ISA) without piggyback modules. The Philips PCA 82C200 chip is used as the CAN controller in this configuration and supports the standard identifier range only. The driver block set for this board is found in the xPC Target I/O block library in the group CAN/Softing.

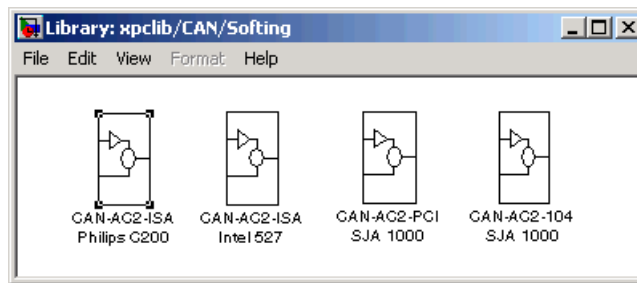

The first group, Phillips C200, contains the three available CAN blocks: Setup, Send, and Receive.

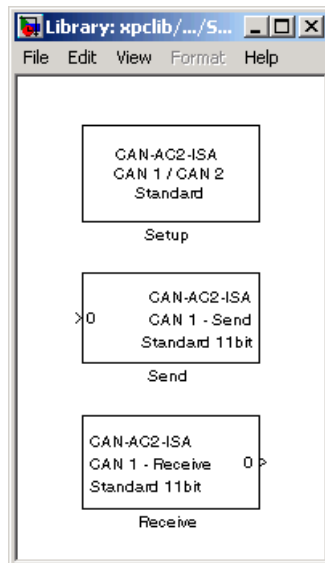

## Setup Driver Block

The Setup block defines general settings of the installed CAN board. Because the CAN driver blocks for this ISA board only support a single physical board for each target system, this block can only be used once (one instance) in a model.

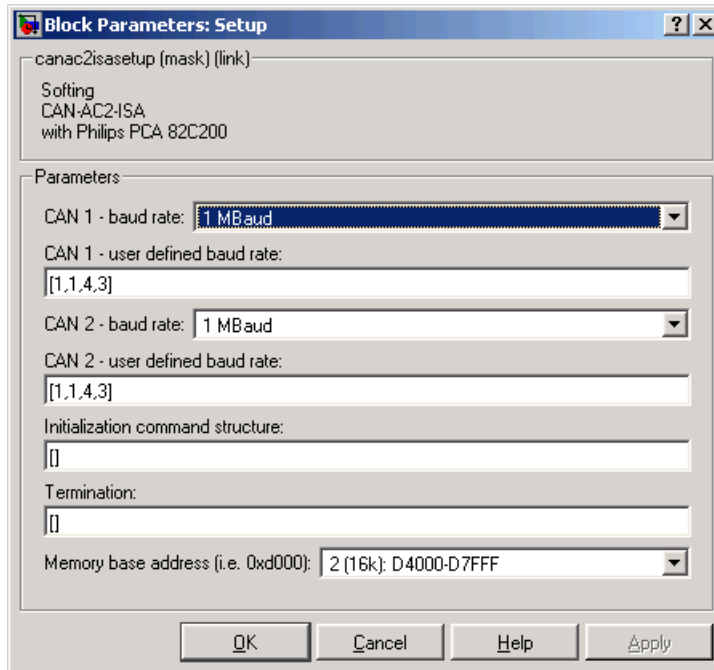

**CAN 1 - baud rate** — Defines the most common baud rates for CAN port 1. If special timing is necessary (baud rate), select the value `User defined`. In this case, use **CAN 1 - user defined baud rate** to provide the four values for the timing information. The vector elements have the following meanings:

```
[ Prescaler, Synchronization-Jump-Width, Time-Segment-1,
  Time-Segment-2 ]
```

For more information about these values, see the Softing user manual for this board.

**CAN 2 - baud rate** — Defines the most common baud rates for CAN port 2. If special timing is necessary (baud rate), the value `User defined` can be selected.

In this case, use **CAN 1 - User defined baud rate** to provide the four values for the timing information. The vector elements have the following meanings:

```
[ Prescaler, Synchronization-Jump-Width, Time-Segment-1,  
  Time-Segment-2 ]
```

For more information about these values, see the Softing user manual for this board.

**Initialization command structure and Termination** — Defines CAN messages sent during initialization and termination of the Setup block.

**Memory base address** — Defines the memory base address of the board. Hardware jumpers on the board itself set the address range that the board uses. Refer to the Softing user manual on how to set the various address ranges. The setting in the dialog box must correspond to the jumper setting; otherwise the board cannot be accessed. The available address ranges (memory base address) in the pop-up menu are those supported by the board. Because the xPC Target kernel only reserves a subrange (C0000 to DC000) of the 640 KB to 1 MB address range for memory-mapped devices, the valid settings when used within a xPC target system are

- 1 (16k): D0000-D3FFF
- 2 (16k): D4000-D7FFF

The board allows you to terminate each of the two CAN ports separately by means of hardware jumpers. Refer to the Softing user manual on how to set the jumpers. Both CAN ports must be terminated properly when you use the loop-back model provided to test the board and drivers.

## Send Driver Block

The Send driver block transmits data to a CAN network from within a block model.

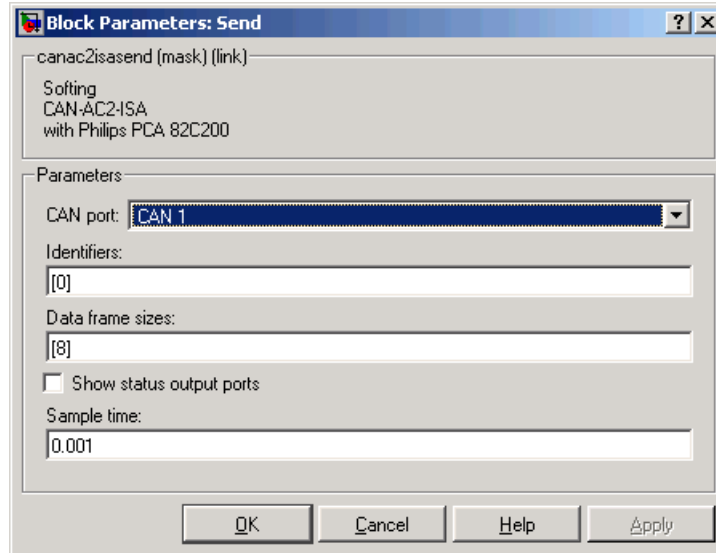

**CAN port** — Selects the CAN port to which the CAN message is sent.

**Identifiers** — Defines the identifiers of the CAN messages sent by this block. It must be a row vector where the elements define a set of standard identifiers. Each element must be in the range between 0 and 2031. The number of identifiers for each CAN port in a model per physical CAN board cannot exceed 200 (limitation of the firmware's dynamic object mode). The number of elements defined here also specifies the number of input ports of the block. The block icon displays the selected identifier at each input port. Each input port accepts the data frame to be sent along with the CAN message. The signal entering each input port must be a scalar of type double representing the maximum size of 8 bytes of a CAN message data frame.

**Data frame sizes** — Defines the data frame size for each identifier (CAN message) in bytes. It must be a row vector in which the elements define a set of data frame sizes. Each element must be in the range between 1 and 8. If the data frame sizes for all the identifiers defined in the **Identifiers** parameter must be the same, you can provide the size as a scalar only and scalar

expansion applies. If the sizes are different for at least two identifiers (CAN messages), you must provide one size element for each identifier defined in the **Identifiers** parameter. Therefore the length of the two vectors must be the same.

**Show status output ports** — Enables status output ports for each identifier (CAN message). If the check box is checked the block shows as many output ports as input ports. The data type of each output port is a double and the value is identical to the return argument of function `CANPC_write_object(...)`, described in the Softing user manual. Refer to the manual for more information.

**Sample time** — Defines the sample time at which the Send block is executed during a model (target application) run.

You can use as many instances of the Send block in the model as needed. For example, by using two instances of the block with different sample times, you can send CAN messages out at different rates. Or you can use multiple instances to structure your model more efficiently.

## Receive Driver Block

The Receive driver block retrieves data from a CAN network to be used within a block model.

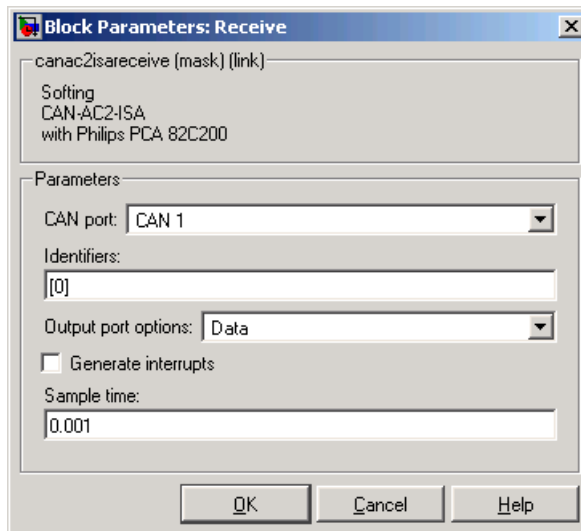

**CAN port** — Defines the CAN port from which the CAN messages are retrieved.

**Identifiers** — Defines the identifiers of the CAN messages retrieved by this block. It must be a row vector in which the elements define a set of standard identifiers. Each element must be in the range between 0 and 2031. The number of identifiers for each CAN port in a model per physical CAN board cannot exceed 200 (limitation of the firmware's dynamic object mode). The number of elements defined here, also defines the number of output ports of the block. The block icon displays the selected identifier at each output port. Each output port outputs the data frame being retrieved along with the CAN message. The signal leaving each output port is a scalar of type double representing the maximum size of 8 bytes of a CAN message data frame.

**Output port options** — Defines the type of retrieved data output at each output port. Three different types of data can be output, data frame, status, and timestamp. The status information is of type double and is identical to the return value of function `CANPC_read_rcv_data(...)`, described in the Softing user manual. Refer to the manual for more information. The timestamp information is of type double and outputs the latest time at which a CAN message with the corresponding identifier was received. This time information in seconds (with a resolution of 1 microsecond) can be used to implement time-out logic within your model.

The pop-up menu lets you select the output information output at each output port of the block. If you select Data, each output port signal is a scalar only. If you select Data - Status, each output port signal is a vector with two elements in which the first element contains the data frame and the second element the status information. If you select Data - Status - Timestamp, each output port signal is a vector with three elements in which the first element contains the data frame, the second element the status information, and the third element the timestamp.

**Generate interrupts** — Defines whether the CAN messages defined in this instance of the block initiate an interrupt from the CAN board each time they are received. If selected, you can use CAN messages to control model (target application) execution.

**Sample time** — Defines the sample time at which the Receive block is executed during a model (target application) run.



You can use as many instances of the Receive block in the model as needed. For example, by using two instances of the block with different sample times, you can retrieve CAN messages at different rates. Or you can use multiple instances to structure your model more efficiently.

# CAN Driver Blocks for the CAN-AC2 (ISA) with Intel 82527 CAN Controller

The driver blocks described here support the CAN-AC2 (ISA) with piggyback modules. The Intel 82527 chip is used as the CAN controller in this configuration and supports both standard and extended identifier ranges in parallel. The driver block set for this board is found in the xPC Target I/O block library in the group CAN/Softing.

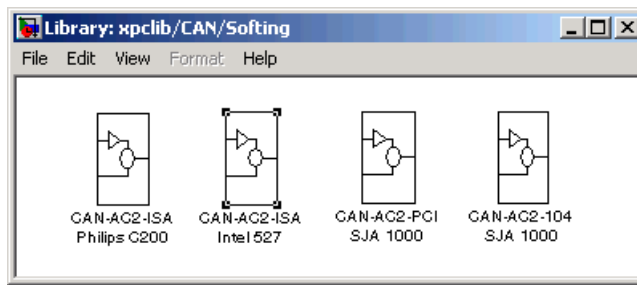

The second block, CAN-AC2-ISA Intel527, contains the three available CAN blocks: Setup, Send, and Receive.

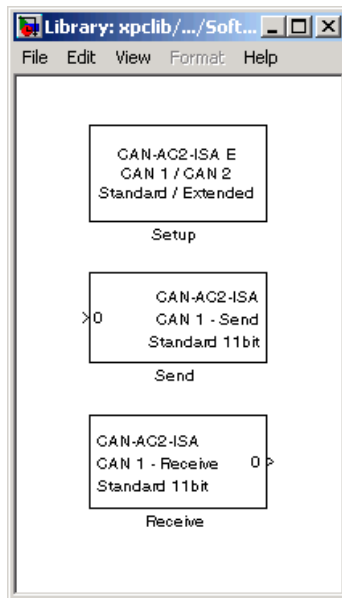

## Setup Driver Block

The Setup block defines general settings of the installed CAN board. Because the CAN driver blocks for this board only supports a single physical board for each target system, this block can only be used once (one instance) in a model.

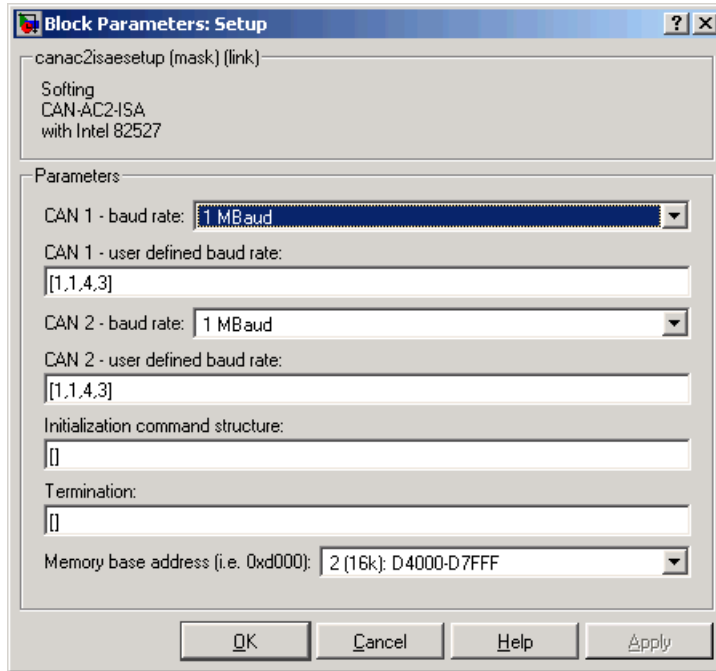

**CAN 1 - baud rate** — Defines the most common baud rates for CAN port 1. If special timing is necessary (baud rate), the value `User defined` can be selected. In this case, use the **CAN 1 - user-defined baud rate** parameter to provide the four values for the timing information. The vector elements have the following meanings:

[ Prescaler, Synchronization-Jump-Width, Time-Segment-1, Time-Segment-2 ]

For more information about these values, see the Softing user manual for this board.

**CAN 2 - baud rate** — Defines the most common baud rates for CAN port 1. If special timing is necessary (baud rate), the value `User defined` can be selected. In this case, use **CAN 1 - user-defined baud rate** parameter the four values for the timing information. The vector elements have the following meanings:

[ Prescaler, Synchronization-Jump-Width, Time-Segment-1, Time-Segment-2 ]

For more information about these values, see the Softing user manual for this board.

**Initialization command structure and Termination** — Define CAN messages sent during initialization and termination of the Setup block.

**Memory base address** — Defines the memory base address of the board. The address range used by the board must be set by hardware jumpers on the board itself. Refer to the Softing user manual on how to set the various address ranges. The setting in the dialog box must correspond to the jumper setting; otherwise the board cannot be accessed. The available address ranges (memory base address) in the pop-up menu are those supported by the board. Because the xPC Target kernel only reserves a subrange (C0000 to DC000) of the 640 KB to 1 MB address range for memory-mapped devices, the valid settings when used within a xPC Target system only are

- 1 (16k): D0000-D3FFF
- 2 (16k): D4000-D7FFF

The board allows you to terminate each of the two CAN ports separately by means of hardware jumpers. Refer to the Softing user manual on how to set the jumpers. Both CAN ports must be terminated properly when you use the loop-back model provided to test the board and drivers.

## Send Driver Block

The Send driver block transmits data to a CAN network from within a block model.

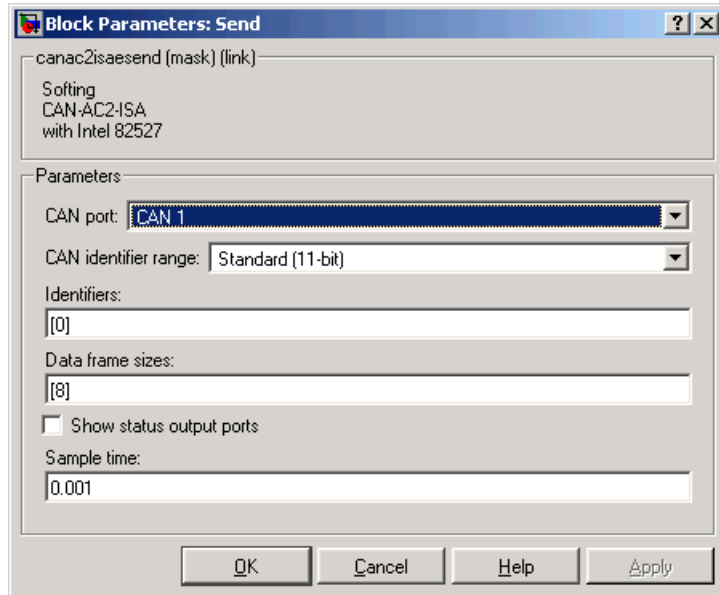

**CAN port** — Selects the CAN port to which the CAN message is sent.

**CAN identifier range** — Selects the identifier range of the CAN messages sent by this block instance. If an application makes use of mixed standard and extended identifier ranges, you must use at least two instances of this block, each defining the corresponding identifier range.

**Identifiers** — Defines the identifiers of the CAN messages sent by this block. It must be a row vector in which the elements define a set of either standard or extended identifiers. Each element must be in the range between 0 and 2031 for standard identifiers or 0 and  $2^{29} - 1$  for extended identifiers. The number of identifiers for each CAN port in a model per physical CAN board cannot exceed 200 (limitation of the firmware's dynamic object mode). The number of elements defined here also defines the number of input ports of the block. The block icon displays the selected identifier at each input port. Each input port accepts the data frame to be sent along with the CAN message. The signal

entering each input port must be a scalar of type double representing the maximum size of 8 bytes of a CAN message data frame.

**Data frame sizes** — Defines the data frame size for each identifier (CAN message) in bytes. It must be a row vector where the elements define a set of data frame sizes. Each element must be in the range between 1 and 8. If the data frame sizes for all identifiers defined in the **Identifiers** parameter must be the same, you can provide the size as a scalar only and scalar expansion applies. If the sizes are different for at least two identifiers (CAN messages), you can provide one size element for each identifier defined in the **Identifiers** parameter. Therefore the length of the two vectors must be the same.

**Show status: Output ports** — Enables status output ports for each identifier (CAN message). If the check box is checked, the block shows as many output ports as input ports. The data type of each output port is a double and the value is identical to the return argument of function `CANPC_write_object(...)`, described in the Softing user manual. Refer to the manual for more information.

**Sample time** — Defines the sample time at which the Send block is executed during a model (target application) run.

You can use as many instances of the Send block in the model as needed. For example, by using two instances of the block, you can send CAN messages at different sample times. Or you can use multiple instances to structure your model more efficiently.

## Receive Driver Block

The Receive driver block retrieves data from a CAN network to be used within a block model.

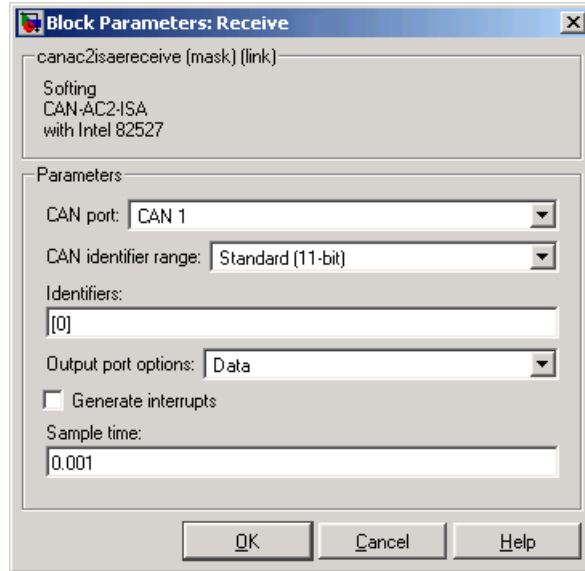

**CAN port** — Selects the CAN port from which to retrieve the CAN messages.

**CAN identifier range** — Selects the identifier range of the CAN messages retrieved by this block instance. If an application makes use of mixed standard and extended identifier ranges, you must use at least two instances of this block, each defining the corresponding identifier range.

**Identifiers** — Defines the identifiers of the CAN messages retrieved by this block. It must be a row vector in which the elements define a set of either standard or extended identifiers. Each element must be in the range between 0 and 2031 for standard identifiers or 0 and  $2^{29} - 1$  for extended identifiers. The number of identifiers for each CAN port in a model per physical CAN board cannot exceed 200 (limitation of the firmware's dynamic object mode). The number of elements defined here also defines the number of output ports of the block. The block icon displays the selected identifier at each output port. Each output port outputs the data frame being retrieved along with the CAN



message. The signal leaving each output port is a scalar of type double representing the maximum size of 8 bytes of a CAN message data frame.

**Output port options** — Defines the type of retrieved data output at each output port. Three different types of data can be output, data frame, status, and timestamp. The status information is of type double and is identical to the return value of function `CANPC_read_rcv_data(...)`, described in the Softing user manual. Refer to the manual for more information. The timestamp information is of type double and outputs the latest time at which a CAN message with the corresponding identifier was received. This time information in seconds (with a resolution of 1 microsecond) can be used to implement time-out logic within your model.

The pop-up menu lets you select the output information output at each output port of the block. If you select Data, each output port signal is a scalar only. If you select Data - Status, each output port signal is a vector with two elements in which the first element contains the data frame and the second element the status information. If you select Data - Status - Timestamp, each output port signal is a vector with three elements in which the first element contains the data frame, the second element the status information, and the third element the timestamp.

**Generate interrupts** — Defines whether the CAN messages defined in this instance of the block initiate an interrupt from the CAN board each time they are received. If selected, you can use CAN messages to control model (target application) execution.

**Sample time** — Defines the sample time at which the Send block is executed during a model (target application) run.

You can use as many instances of the Receive block in the model as needed. For example, by using two instances of the block, you can send CAN messages at different sample times. Or you can use multiple instances to structure your model more efficiently.

## CAN Driver Blocks for the CAN-AC2-PCI with Philips SJA1000 CAN Controller

The driver blocks described here support the CAN-AC2-PCI. The Philips SJA1000 chip is used as the CAN controller in this configuration and supports both standard and extended identifier ranges in parallel. The driver block set for this board is found in the xPC Target I/O block library in the group CAN/Softing.

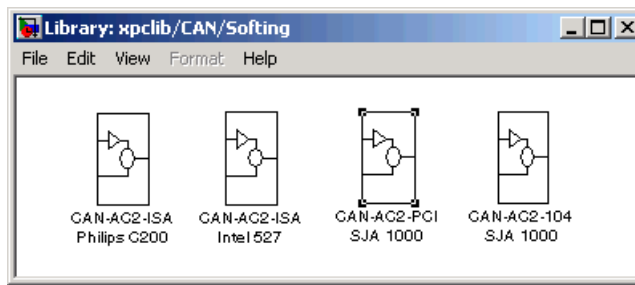

The third block group, CAN-AC2-PCI SJA 1000, contains the three available CAN blocks: Setup, Send, and Receive, plus a FIFO Mode block, which is discussed in Chapter 5, "CAN I/O Support for FIFO."

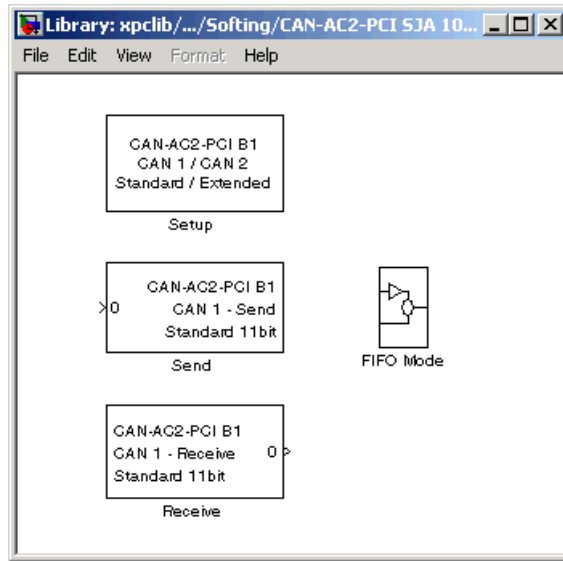

## Setup Driver Block

The Setup block defines general settings of the installed CAN boards. The CAN driver blocks for this board support up to three boards for each target system, making up to six CAN ports available. For each board in the target system, you must use exactly one Setup driver block.

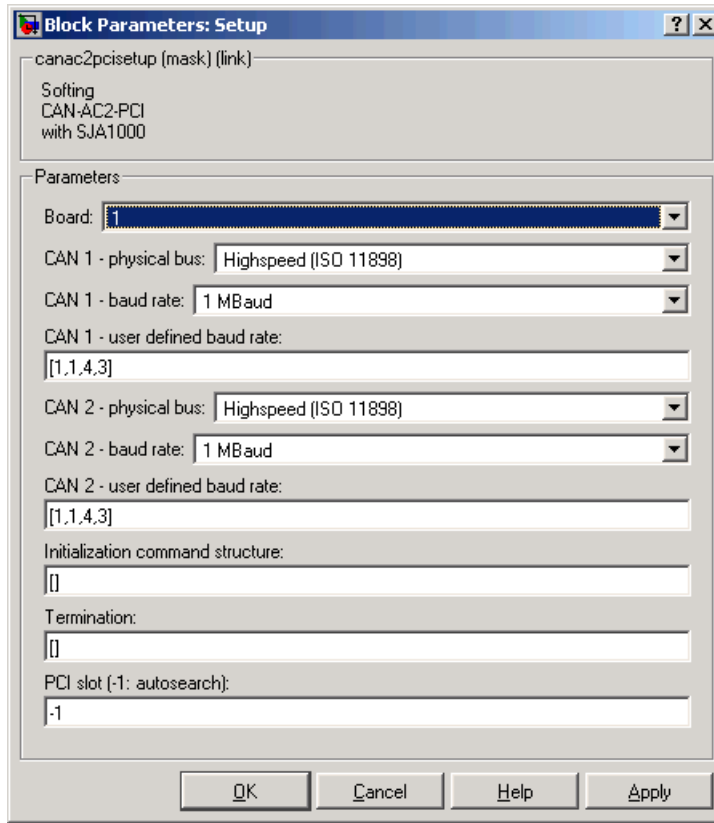

**Board** — Defines the board being accessed by this driver block instance. If multiple boards are present in the target PC, you can use the board number (1...3) to differentiate the boards. The physical board referenced by the board number depends on the **PCI Slot** parameter. If just one board is present in the target system, select board number 1.

**CAN 1 - physical bus** — Defines the physical CAN bus type of CAN port 1. In the board's standard hardware configuration, only high-speed CAN is supported. By extending the board with low-speed CAN piggyback modules, you can also select low-speed CAN as the physical bus. Do not change this value to low-speed if no module is present for the corresponding CAN port. If the module is present (see the Softing user manual on how to install the modules), you can select between high-speed and low-speed CAN here.

**CAN 1 - baud rate** — Defines the most common baud rates for CAN port 1. If special timing is necessary (baud rate), you can select the value `User defined`. In this case, you use the **CAN 1 - user defined baud rate** parameter to provide the four values for the timing information. The vector elements have the following meanings:

```
[ Prescaler, Synchronization-Jump-Width, Time-Segment-1,  
  Time-Segment-2 ]
```

For more information about these values, see the Softing user manual for this board.

**CAN 2 - physical bus** — Defines the physical CAN bus type of CAN port 2. In the board's standard hardware configuration, only high-speed CAN is supported. By extending the board with low-speed CAN piggyback modules, you can also select low-speed CAN as the physical bus. Do not set this value should to low-speed if no module is present for the corresponding CAN port. If the module is present (see the Softing user manual on how to install the modules), you can select between high-speed and low-speed CAN here.

**CAN 2 - baud rate** — Defines the most common baud rates for CAN port 2. If special timing is necessary (baud rate), the value `User defined` can be selected. In this case, you can use the **CAN 2 - user defined baud rate** parameter to provide the four values for the timing information. The vector elements have the following meanings:

```
[ Prescaler, Synchronization-Jump-Width, Time-Segment-1,  
  Time-Segment-2 ]
```

For more information about these values, see the Softing user manual for this board.

**Initialization command structure and Termination** — Defines CAN messages sent during initialization and termination of the Setup block.

**PCI slot (-1: autosearch)** — Defines the PCI slot in which the referenced board (board number) resides. If only one board is present in the target system, set the value for this control to -1 (autosearch). This ensures that the xPC Target kernel automatically finds the board regardless of the PCI slot it is plugged into. If two or more boards of this type are physically present in the target PC, enter the bus number and the PCI slot number of the board associated with this driver block. Use the format `[BusNumber, SlotNumber]`. Use the xPC Target

function `getxpcpci` to query the target system for installed PCI boards and the PCI slots they are plugged into. For more information see `help getxpcpci`.

The board allows you to terminate each of the two CAN ports separately by means of DIP switches at the rear panel. Refer to the Softing user manual on how to set the DIP switches. Both CAN ports must be terminated properly when you use the loop-back model provided to test the board and drivers.

### Send Driver Block

The Send driver block transmits data to a CAN network from within a block model.

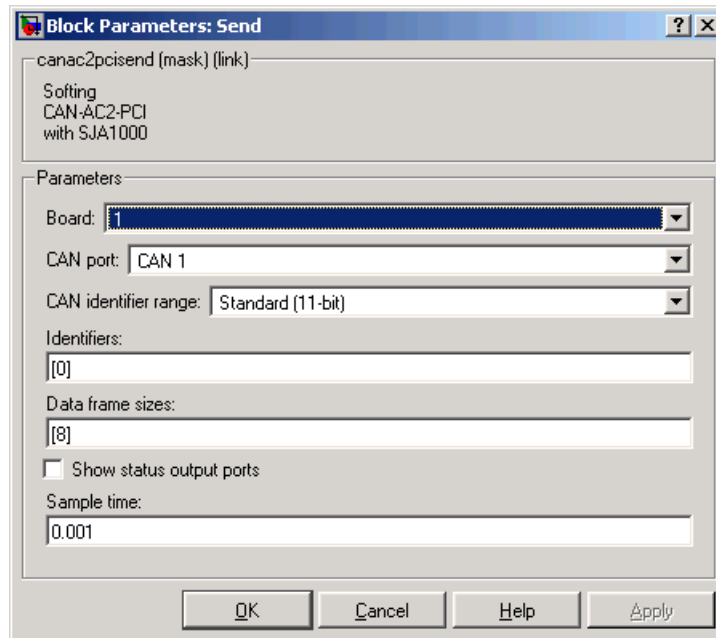

**Board** — Defines the board used to send out the CAN messages defined by this block instance. For more information about the meaning of the board number see the Setup driver block described above. If just one board is present in the target system, select board number 1.

**CAN port** — Selects the CAN port to which the CAN message is sent.

**CAN identifier range** — Selects the identifier range of the CAN messages sent by this block instance. If an application makes use of mixed standard and extended identifier ranges, you must use at least two instances of this block, each defining the corresponding identifier range.

**Identifiers** — Defines the identifiers of the CAN messages sent by this block. It must be a row vector in which the elements define a set of either standard or extended identifiers. Each element must be in the range between 0 and 2031 for standard identifiers or 0 and  $2^{29} - 1$  for extended identifiers. The number of identifiers for each CAN port in a model per physical CAN board cannot exceed 200 (limitation of the firmware's dynamic object mode). The number of elements defined here also define the number of input ports of the block. The block icon displays the selected identifier at each input port. Each input port accepts the data frame to be sent along with the CAN message. The signal entering each input port must be a scalar of type double representing the maximum size of 8 bytes of a CAN message data frame.

**Data frame sizes** — Defines the data frame size for each identifier (CAN message) in bytes. It must be a row vector in which the elements define a set of data frame sizes. Each element must be in the range between 1 and 8. If the data frame sizes for all identifiers defined in the control above must be the same, you can provide the size as a scalar only and scalar expansion applies. If the sizes are different for at least two identifiers (CAN messages), you must provide one size element for each identifier defined in the **Identifiers** parameter. Therefore the lengths of the two vectors must be the same.

**Show status output ports** — Enables status output ports for each identifier (CAN message). If the check box is checked the block shows as many output ports as input ports. The data type of each output port is a double and the value is identical to the return argument of function `CANPC_write_object(...)`, described in the Softing user manual. Refer to the manual for more information.

**Sample time** — Defines the sample time at which the Send block is executed during a model (target application) run.

You can use as many instances of the Send block in the model as needed. For example, by using two instances of the block, you can send CAN messages at different sample times. Or you can use multiple instances to structure your model more efficiently.

## Receive Driver Block

The Receive driver block retrieves data from a CAN network to be used within a block model. You can use as many instances of the Receive block in the model as needed.

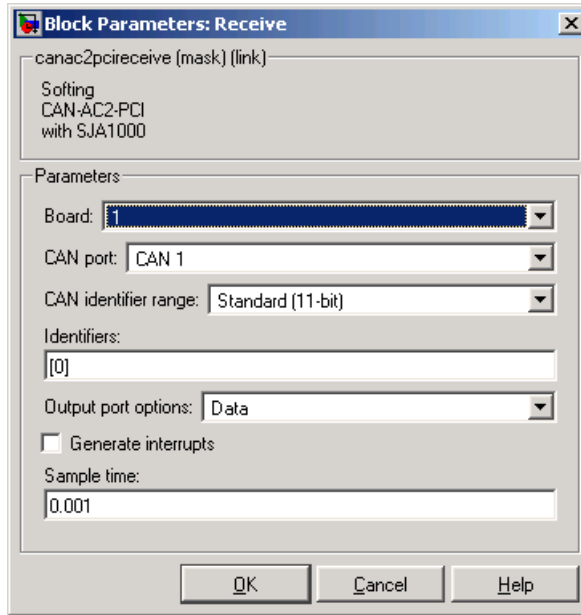

**Board** — Defines the board the CAN messages defined by this block instance are retrieved from. For more information about the meaning of the board number, see the Setup driver block described above. If just one board is present in the target system, select board number 1.

**CAN port** — Selects the CAN port from which the CAN messages are retrieved.

**CAN identifier range** — Selects the identifier range of the CAN messages retrieved by this block instance. If an application makes use of mixed standard and extended identifier ranges, you must use at least two instances of this block, each defining the corresponding identifier range.

**Identifiers** — Defines the identifiers of the CAN messages retrieved by this block. It must be a row vector in which the elements define a set of either standard or extended identifiers. Each element must be in the range between



0 and 2031 for standard identifiers or 0 and  $2^{29} - 1$  for extended identifiers. The number of identifiers for each CAN port in a model per physical CAN board cannot exceed 200 (limitation of the firmware's dynamic object mode). The number of elements defined here also defines the number of output ports of the block. The block icon displays the selected identifier at each output port. Each output port outputs the data frame being retrieved along with the CAN message. The signal leaving each output port is a scalar of type double representing the maximum size of 8 bytes of a CAN message data frame.

**Output port options** — Defines the type of retrieved data output at each output port. Three different types of data can be output, data frame, status, and timestamp. The status information is of type double and is identical to the return value of function `CANPC_read_rcv_data (...)`, described in the Softing user manual. Refer to the manual for more information. The timestamp information is of type double and outputs the latest time at which a CAN message with the corresponding identifier was received. This time information in seconds (with a resolution of 1 microsecond) can be used to implement time-out logic within your model. The pop-up menu lets you select the output information at each output port of the block. If you select Data, each output port signal is a scalar only. If you select Data - Status, each output port signal is a vector with two elements, in which the first element contains the data frame and the second element the status information. If you select Data - Status - Timestamp, each output port signal is a vector with three elements, in which the first element contains the data frame, the second element the status information, and the third element the timestamp.

**Generate interrupts** — Defines whether the CAN messages defined in this instance of the block will initiate an interrupt from the CAN board each time they are received. If selected, you can use CAN messages to control model (target application) execution.

**Sample time** — Defines the sample time at which the Send block is executed during a model (target application) run.

You can use as many instances of the Send block in the model as needed. For example, by using two instances of the block, you can send CAN messages at different sample times. Or you can use multiple instances to structure your model more efficiently.

# CAN Driver Blocks for the CAN-AC2-104 (PC/104) with Philips SJA1000 CAN Controller

The driver blocks described here support the CAN-AC2-104 (PC/104). The Philips SJA1000 chip is used as the CAN controller in this configuration and supports both standard and extended identifier ranges in parallel. The driver block set for this board is found in the xPC Target I/O block library in the group CAN/Softing.

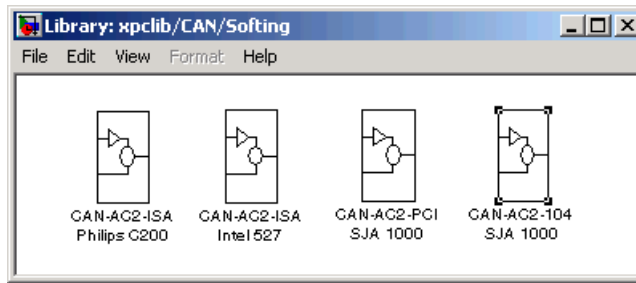

The fourth block group, CAN-AC2-104 SJA 1000, contains the three available CAN blocks: Setup, Send, and Receive, plus a FIFO Mode block, which is discussed in Chapter 5, "CAN I/O Support for FIFO."

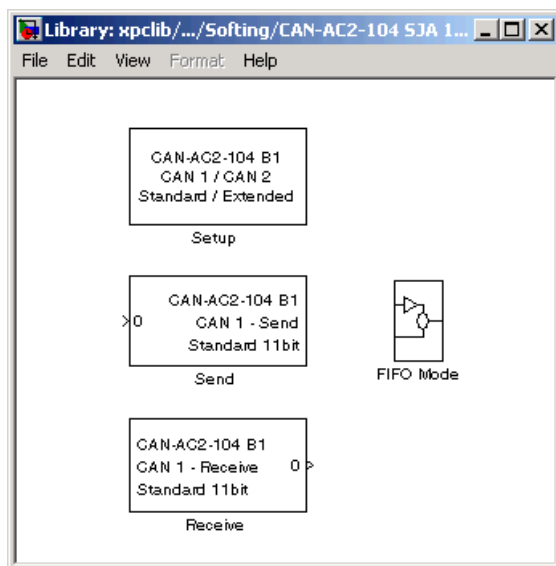

## Setup Driver Block

The Setup block defines general settings of the stacked CAN boards. The CAN driver blocks for this board support up to three boards for each target system, making up to six CAN ports available. For each board in the target system, you must use exactly one Setup driver block.

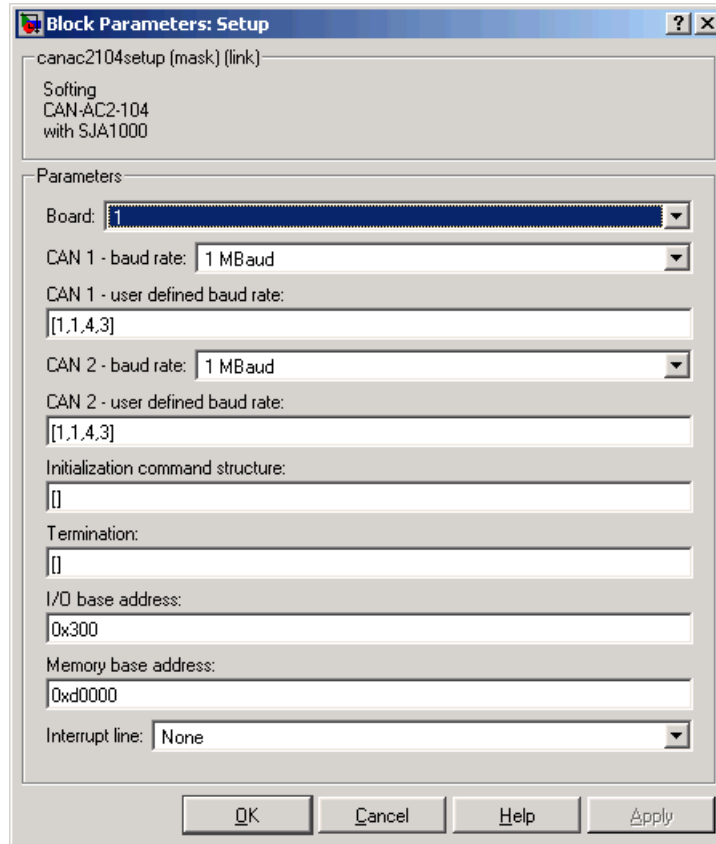

**Board** — Defines the board being accessed by this driver block instance. If multiple boards are present in the target PC, you can use the board number (1...3) to differentiate the boards. The physical board referenced by the board number depends on the **PCI Slot** parameter. If just one board is present in the target system, select board number 1. The physical board referenced by the board number depends on the **I/O base address** parameter.

**CAN 1 - baud rate** — Defines the most common baud rates for CAN port 1. If special timing is necessary (baud rate), you can select the value **User defined**. In this case, use the **CAN 1 - user defined baud rate** parameter to provide the four values for the timing information. The vector elements have the following meanings:

```
[ Prescaler, Synchronization-Jump-Width, Time-Segment-1,  
Time-Segment-2 ]
```

For more information about these values, see the Softing user manual for this board.

**CAN 2 - baud rate** — Defines the most common baud rates for CAN port 2. If special timing is necessary (baud rate), you can select the value `User defined`. In this case, use the **CAN 2 - user defined baud rate** parameter to provide the four values for the timing information. The vector elements have the following meanings:

```
[ Prescaler, Synchronization-Jump-Width, Time-Segment-1,  
Time-Segment-2 ]
```

For more information about these values, see the Softing user manual for this board.

**Initialization command structure and Termination** — Define CAN messages sent during initialization and termination of the Setup block.

**I/O base address** — Defines the I/O base address of the board to be accessed by this block instance. The I/O base address is given by the DIP switch setting on the board itself. The I/O address range is 3 bytes and is mainly used to transfer the memory base address the board should use. See the Softing user manual for this board to set the I/O base address. The I/O base address entered in this control must correspond with the DIP switch setting on the board. If more than one board is present in the target system, a different I/O base address must be entered for each board. In this case the I/O base address itself defines which board is referenced by which board number.

**Memory base address** — Defines the memory base address of the board to be accessed by this block instance. The memory base address is a software setting only (no corresponding DIP switch is found on the board). The memory address range is 4 KB. If more than one board is present in the target system, a different memory base address must be entered for each board. You must make sure that the defined address ranges do not overlap. Because the xPC Target kernel only reserves a subset of the address range between 640 KB and 1 MB for memory mapped devices, the address ranges must lie within the following range:

```
C0000 - DC000
```

The board allows you to terminate each of the two CAN ports separately by means of jumpers found on the board. Refer to the board user manual for how the DIP switches must be set. Both CAN ports must be terminated properly when you use the loop-back model provided to test the board and drivers.

**Interrupt line** — Selects an interrupt line from the list.

## Send Driver Block

The Send driver block transmits data to a CAN network from within a block model. You can define up to 200 send objects for standard and extended identifiers for each CAN channel.

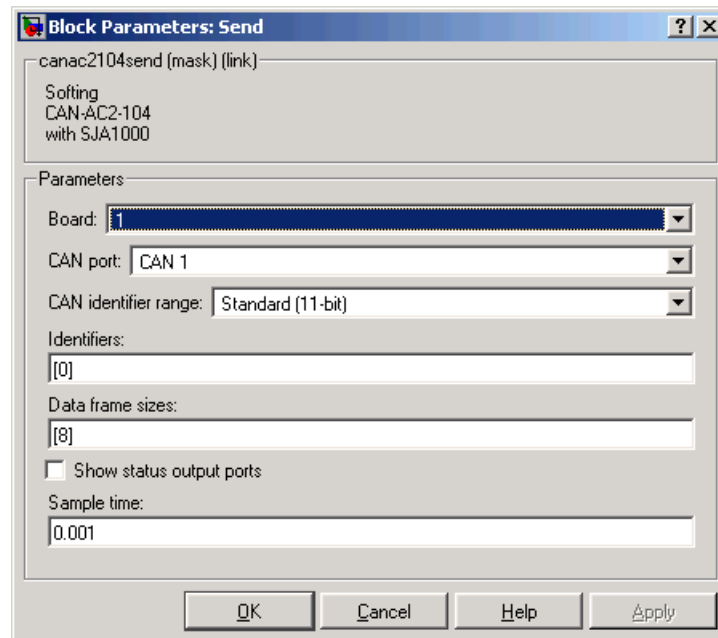

**Board** — Defines the board to use to send the CAN messages defined by this block instance. For more information about the meaning of the board number, see the Setup driver block described above. If just one board is present in the target system, select board number 1.

**CAN Port** — Selects the CAN port to send the CAN message.

**CAN identifier range** — Selects the identifier range of the CAN messages sent by this block instance. If an application makes use of mixed standard and extended identifier ranges, you must use at least two instances of this block, each defining the corresponding identifier range.

**Identifiers** — Defines the identifiers of the CAN messages sent by this block. It must be a row vector in which the elements define a set of either standard or extended identifiers. Each element must be in the range between 0 and 2031 for standard identifiers or 0 and  $2^{29} - 1$  for extended identifiers. The number of identifiers for each CAN port in a model per physical CAN board cannot exceed 200. The number of elements defined also defines the number of input ports of the block. The block icon displays the selected identifier at each input port. Each input port accepts the data frame to be sent along with the CAN message. The signal entering each input port must be a scalar of type double representing the maximum size of 8 bytes of a CAN message data frame.

**Data frame sizes** — Defines the data frame size for each identifier (CAN message) in bytes. It must be a row vector in which the elements define a set of data frame sizes. Each element must be in the range between 1 and 8. If the data frame sizes for all identifiers defined in the preceding control must be the same, you can provide the size as a scalar only and scalar expansion applies. If the sizes are different for at least two identifiers (CAN messages), one size element must be provided for each identifier specified in the **Identifiers** control. Therefore the lengths of the two vectors must be the same.

**Show status output ports** — Enables status output ports for each identifier (CAN message). If the check box is selected, the block shows as many output ports as input ports. The data type of each output port is a double and the value is identical to the return argument of function `CANPC_write_object(...)`, described in the Softing user manual. Refer to the manual for more information.

**Sample time** — Defines the sample time at which the Send block is executed during a model (target application) run.

You can use as many instances of the Send block in the model as needed. For example, by using two instances of the block, you can define different sample times at which CAN messages are sent out. Or you can use multiple instances to structure your model more efficiently.

## Receive Driver Block

The Receive driver block retrieves data from a CAN network to be used within a block model. You can use as many instances of the Receive block in the model as needed.

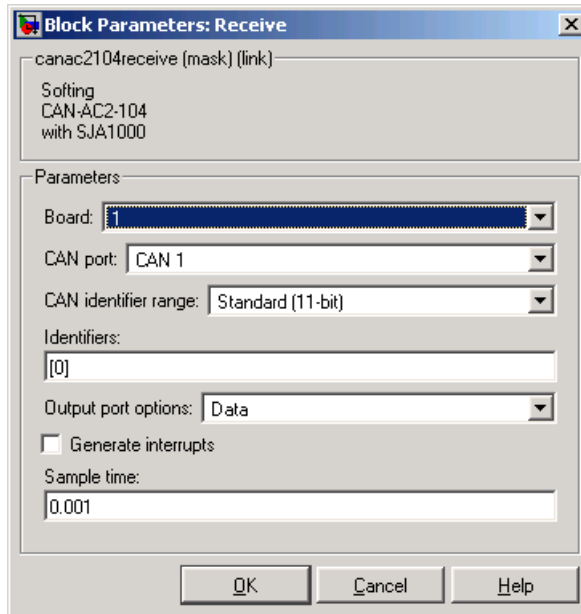

**Board** — Defines the board from which the CAN messages defined by this block instance are to be retrieved. For more information about the meaning of the board number, see the Setup driver block. If just one board is present in the target system, select board number 1.

**CAN Port** — Selects the CAN port from which to retrieve the CAN message.

**CAN identifier range** — Selects the identifier range of the CAN messages retrieved by this block instance. If an application makes use of mixed standard and extended identifier ranges, at least two instances of this block must be used, each defining the corresponding identifier range.

**Identifiers** — Specifies the identifiers of the CAN messages retrieved by this block. It must be a row vector where the elements define a set of either standard or extended identifiers. Each element must be in the range between



0 and 2031 for standard identifiers, or 0 and  $2^{29} - 1$  for extended identifiers. The number of identifiers for each CAN port in a model per physical CAN board cannot exceed 200. The number of elements defined here defines the number of output ports of the block. The block icon displays the selected identifier at each output port. Each output port outputs the data frame being retrieved along with the CAN message. The signal leaving each output port is a scalar of type double representing the maximum size of 8 bytes of a CAN message data frame.

**Output port options** — Defines the type of retrieved data output at each output port. Three different types of data can be output: data frame, status, and timestamp. The status information is of type double and is identical to the return value of function `CANPC_read_rcv_data(...)`, described in the Softing user manual. Refer to the manual for more information. The timestamp information is of type double and outputs the most recent time at which a CAN message with the corresponding identifier was received. This time information in seconds (with a resolution of 1 microsecond) can be used to implement time-out logic within your model.

The pop-up menu lets you select the output information output at each output port of the block. If you select Data, each output port signal is a scalar only. If you select Data-Status, each output port signal is a vector with two elements, in which the first element contains the data frame and the second element the status information. If you select Data-Status-Timestamp, each output port signal is a vector with three elements, in which the first element contains the data frame, the second element the status information, and the third element the timestamp.

**Generate interrupts** — Defines whether the CAN messages defined in this instance of the block initiate an interrupt from the CAN board each time they are received. If selected, you can use CAN messages to control model (target application) execution.

**Sample time** — Defines the sample time at which the Send block is executed during a model (target application) run.

You can use as many instances of the Receive block in the model as needed. For example, by using two instances of the block, you can define different sample times at which CAN messages are retrieved. Or you can use multiple instances to structure your model more efficiently. You can define up to 200 receive objects for standard and extended identifiers for each CAN channel.

## Constructing and Extracting CAN Data Frames

CAN data frames have a maximum size of 8 bytes (64 bits). For the CAN driver blocks found in the xPC Target I/O block library, Simulink signals of data type double are used to propagate data frames as an entity. But in most applications the data frame content does not consist of 64-bit floating point values; instead they are constructed from one or more smaller data type entities such as signed and unsigned integers of various size.

To simplify the construction and extraction of data frames for the user, the xPC Target I/O library contains two utility blocks (found in subgroup CAN/Utilities) that allow bit-packing (construction) and bit-unpacking (extraction) of data frames in a very flexible way.

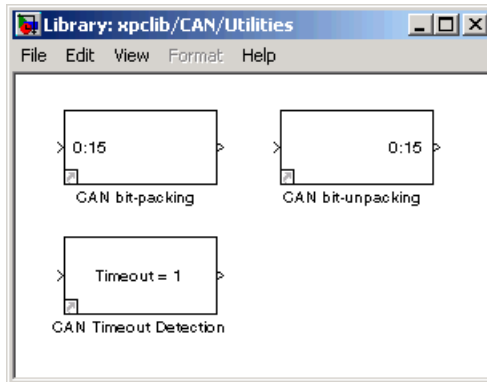

The main purpose of the two blocks is to be used in conjunction with CAN Send and Receive driver blocks, but they can be used as well for other types of data manipulation. Their functionality is entirely independent of any CAN driver blocks or CAN library.

## CAN Bit-Packing Block

This block constructs CAN data frames, and its output port is normally connected to an input port of a CAN Send driver block. The block has one output port of data type double (a scalar), which represents the data frame entity constructed by the signals entering the block at its input ports. The number of input ports and the data type of each input port depend on the setting in the block's dialog box.

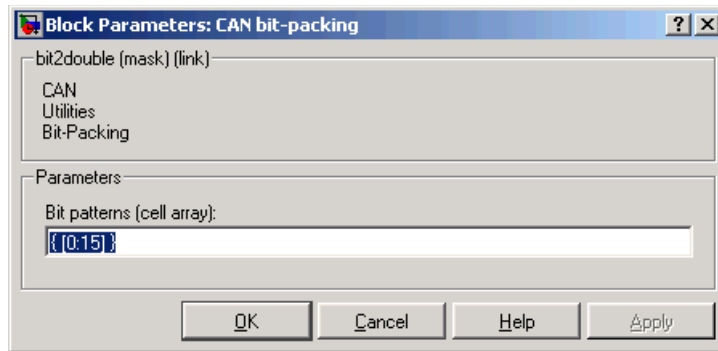

The dialog box contains the **Bit Patterns** parameter, which lets you define the bit patterns in a flexible way. The data type entered in the control must be a MATLAB cell array vector. The number of elements in the cell array define the number of input ports shown by this block instance. The cell array elements must be of type double array and define the position of each bit of the incoming value (data typed input port) in the outgoing double value (data frame).

From a data type perspective (input ports), the block behaves like a Simulink Sink block, and therefore the data types of the input ports are inherited from the driving blocks.

The sample time of the block is also inherited from the driving blocks. Therefore no explicit sample time must be provided in the block's dialog box.

The functionality of the block is best explained by means of an example.

Assume that a node on the CAN network needs to receive a CAN message with identifier 156 having the following data frame content. The data frame must be 6 bytes long.

|              |                                                                                                                     |
|--------------|---------------------------------------------------------------------------------------------------------------------|
| Byte 0       | Function class of type uint8                                                                                        |
| Byte 1       | Function subclass of type uint8 with reversed bit order                                                             |
| Byte 2       | Reserved, all bits must be 1                                                                                        |
| Byte 3       | Bit 0 must be 0, Bit 1 must be a boolean (flag), bits 2 to 7 must be bit 2 to 7 of an incoming int8 value (control) |
| Byte 4 and 5 | Value of type int16                                                                                                 |

The bit pattern cell array, which bit-packs the data frame according to the above specification, can look as follows:

```
{ [0:7] , [15:-1:8] , [16:23] , [25] , [-1,-1,26:31] , [32:47] }
```

And the Simulink model simulating the needed behavior would be as shown.

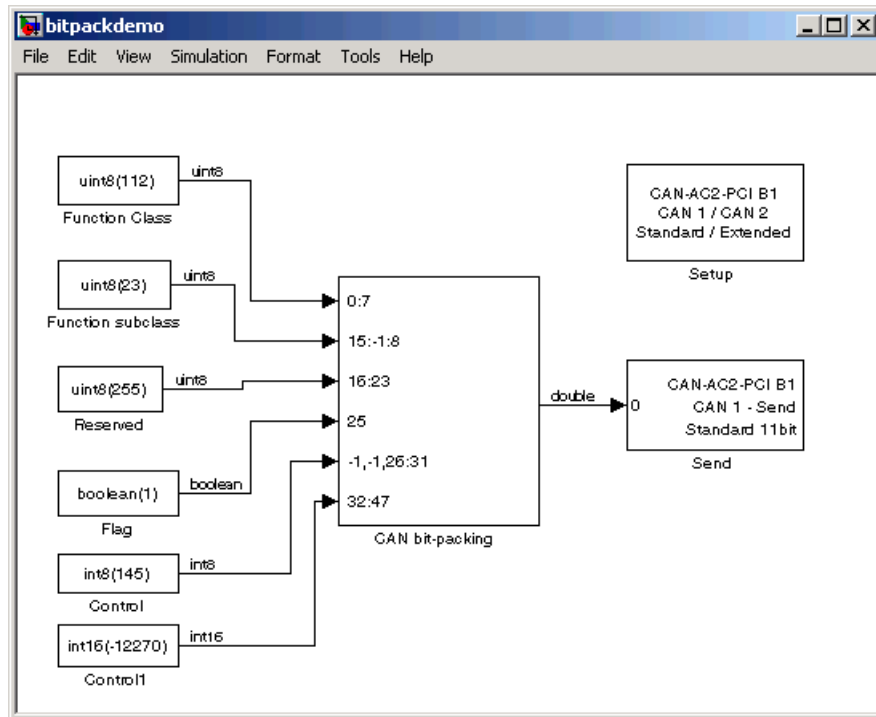

Analyze the model.

The first input is the function class of type `uint8`, which has an example value of 112. This value becomes byte 0 (bits 0 to 7) of the data frame. Therefore the first bit (element 1 of double array [0:7]) gets bit 0 of the data frame, the second bit 1, and so on. It is easiest to define this mapping by the MATLAB colon operator (`:`).

The second input is the function subclass of type `uint8`, which has an example value of 23. This value becomes byte 1 (bits 8:15) of the data frame but in reversed bit order. Therefore the first bit (element 1 of double array [15:-1:8]) gets bit 15, the second bit 14, and so on. It is easiest to define this mapping by the MATLAB colon operator (`:`) and an increment of -1.

The third input is only necessary because the reserved byte 2 must have all bits set to 1. If a bit position in the outgoing data frame is not referenced by a bit pattern array element, the bit is 0 by default, but there is no way to set them

to 1 as the default. Therefore a uint8 constant with value 255 must be brought in externally. The constant 255 must get to bit position 16 to 23 (byte 2) of the outgoing data frame.

Because bit 0 of data frame byte 3 (bit 24) must be 0, and 0 is the default bit value if not referenced by a bit pattern array element, no explicit action is taken here.

The fourth input is the flag of type Boolean, which has an example value of 1. This value must become bit 1 of byte 3 (bit 25) of the data frame. Therefore the single bit (element 1 of double array [25]) must get bit 25 of the data frame.

The fifth input is the control of type int8, which has an example value of 121. But only bits 2 to 7 must be mapped into the outgoing data frame or, in other words, bits 0 and 1 must be thrown away. Because indexing of incoming values always starts with the first bit (bit 0), a special indexing value (-1) must be used to skip bit 0 and 1 of the incoming int8 value. Bits 2 to 7 are directly mapped to bits 2 to 7 of byte 3 (bits 26 to 31) of the outgoing data frame. This leads to the following bit pattern: [-1,-1,26:31].

The sixth input is the value of type int16, which has an example value of -12270. This value must become byte 4 and 5 (bits 32 to 47) of the outgoing data frame. Therefore the first bit (element 1 of double array [32:47]) must get bit 32 of the data frame, the second bit 33, and so on. It is easiest to define this mapping by the MATLAB colon operator (:).

The output of the block then consists of a double value representing the packed data types within the first six bytes. The last two bytes are zero. This means that even in the case where less than eight bytes are significant, the CAN data frame is always represented by a double value (eight bytes). The value of the constructed floating-point double does not have any particular meaning but you still see it with a numerical display.

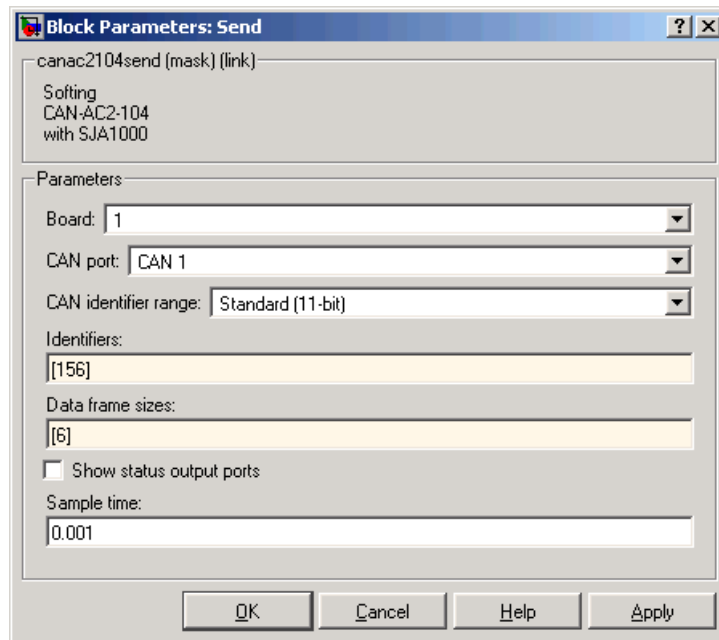

The data frame is then propagated to the CAN Send driver block and is sent as part of a CAN message having identifier 156. In the Send block's dialog box, the data frame size is defined as 6 bytes. This ensures that only the first six bytes of the incoming double value are transmitted as part of the CAN message.

## CAN Bit-Unpacking Block

This block is used to extract CAN data frames, and its input port is normally connected to an output port of a CAN Receive driver block. The block has one input port of data type double (a scalar), which represents the data frame entity from which the signals are extracted and leaving the block at its output ports. The number of output ports and the data type of each output port depend on the settings in the block's dialog box.

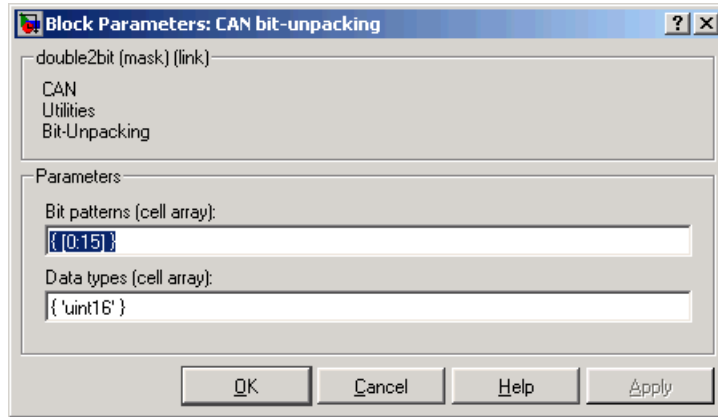

The dialog box contains two controls (edit fields).

The dialog box contains the **Bit Patterns** parameter, which lets you define the bit patterns in a flexible way. The data type entered in the control must be a MATLAB cell array vector. The number of elements in the cell array define the number of input ports shown by this block instance. The cell array elements must be of type double array and define the position of each bit of the incoming value (data typed output port) in the incoming double value (data frame).

From a data type perspective (output ports), the block behaves like a Simulink Source block, and therefore the data types of the output ports must be defined in the second control (edit field). The data type entered in that control must be a MATLAB cell array vector of the same length as the bit pattern cell array. The cell array elements must be of type char and define the data type of the corresponding output port. The following values are supported:

boolean, int8, uint8, int16, uint16, int32, uint32

The sample time of the block is inherited from the driving block. Therefore no explicit sample time need be provided in the block's dialog box.

Note that if you unpack the data frame into a signed type (int8, int 16, or int 32), the block performs sign extension as necessary. For example, if the bit pattern is [0:4], and the data type is int8, you are extracting 5 bits into an 8 bit wide signed type. In this case, bits 5, 6, and 7 are the same as bit 4, resulting in the proper sign extension. This functionality enables you to pack and unpack



negative numbers without losing accuracy. In the preceding example, you can pack and unpack numbers in the range  $[-16 : 15]$  (a fictitious `int5` type).

The functionality of the block is easiest explained by means of an example. The same example as used above demonstrates the functionality of the bit-packing block. But in this case, the data frame is sent by an external CAN node and is received by the target application running on an xPC Target system. Therefore the bit-unpacking block is used to extract the various data fields from the entire data frame. Because the bit pattern definitions of the packing and unpacking block are symmetric, the bit pattern definition could look exactly the same. There is one simple optimization possible: You do not need to extract byte 2 (reserved area), because its content is known. The bit pattern edit field can therefore look as follows:

```
{ [0:7] , [15:-1:8] , [25] , [-1,-1,26:31] , [32:47] }
```

and the data type edit field as

```
{ 'uint8' , 'uint8' , 'boolean' , 'int8' , 'int16' }
```

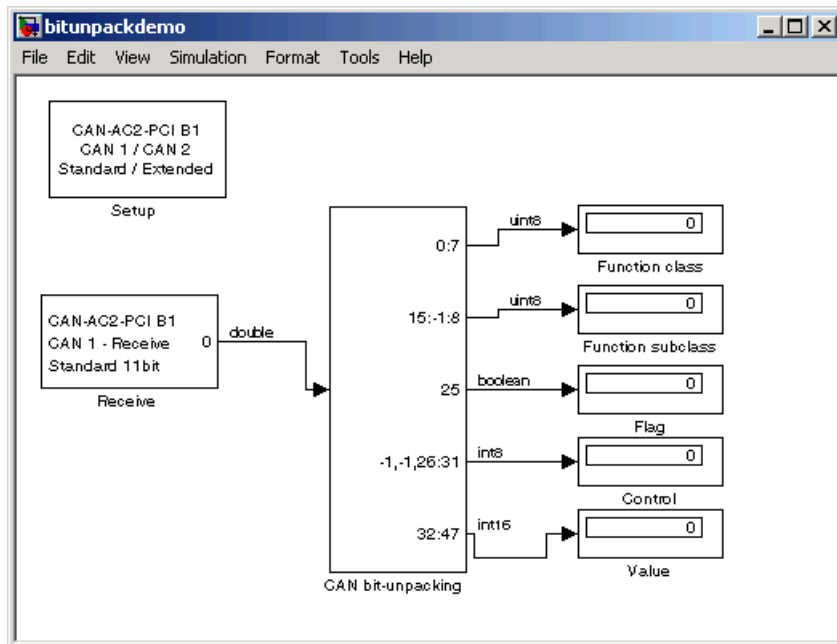

This leads to the following Simulink model.

In many cases it makes sense to test the proper bit-packing and bit-unpacking operations in a Simulink model (simulation) before building the target application. Both blocks work the same way either in Simulink or the generated code. By combining the two models shown so far, a third model emerges that can be used to simulate the behavior.

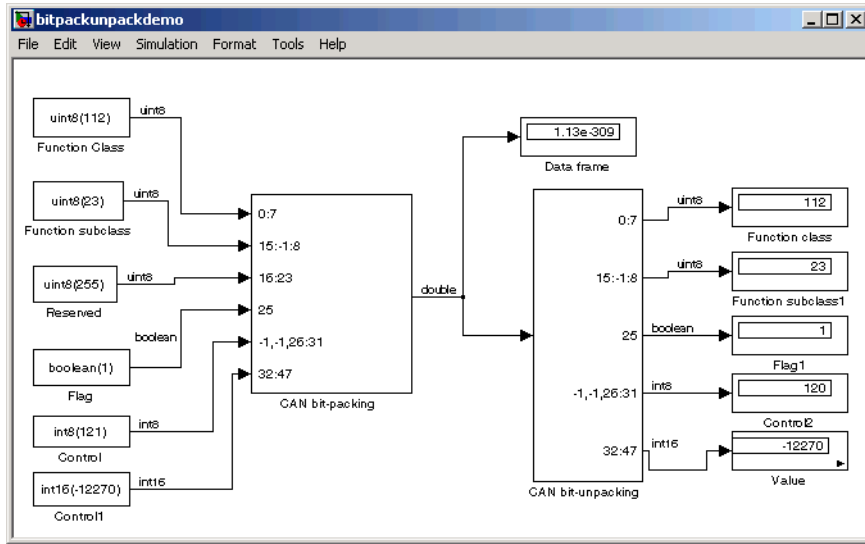

## Detecting Time-Outs When Receiving CAN Messages

The Receive driver blocks for all CAN boards allow you to output the timestamp at which the latest corresponding CAN message was received. This information can be used to detect whether another CAN node is still active and therefore is sending CAN messages or is no longer active and special action must be taken. Assume that a CAN message is expected from another CAN node every 2 milliseconds. If no new message is received within 10 milliseconds, the other CAN node is considered faulty, and the Simulink model (target application) must proceed accordingly.

The CAN blockset in the xPC Target I/O block library provides a utility block called CAN Timeout Detection. This is a simple graphical subsystem (inspect it by looking under its mask) that uses the timestamp information to calculate the time-out condition.

A Simulink model using this block in conjunction with a Receive block could look as follows:

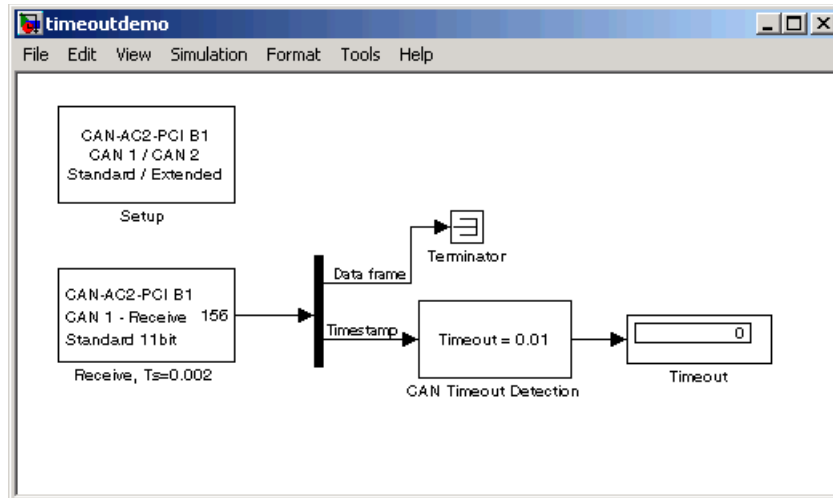

### CAN Timeout Detection Block

The CAN Timeout Detection block uses the timestamp information to calculate the time-out condition. For examples of this block usage, see

- “Detecting Time-Outs When Receiving CAN Messages” on page 4-47 — Detecting time-outs example
- `xpccanpci` — Loop-back example for the CAN-AC2-PCI board
- `xpccanpc104` — Loop-back example for the CAN-AC2-104 board

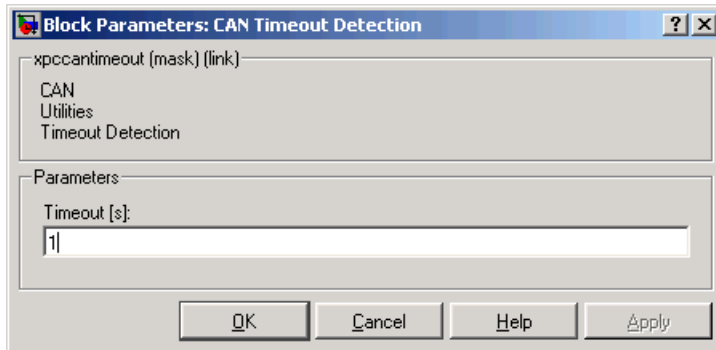

The dialog box of the CAN Timeout Detection block has one edit field.

**Timeout** — Specify the time-out value, in seconds. The output of the block is:

- 0, if no time-out has been detected
- 1, if a time-out has been detected

## Model Execution Driven by CAN Messages (Interrupt Capability of CAN Receive Blocks)

In certain applications, the model (target application) execution is driven by the pace of an incoming CAN message. The standard behavior of the xPC Target kernel is to drive the model (target application) in time monotonic fashion (time interrupt). However, the driving interrupt can be replaced by any other hardware interrupt. Because the three supported CAN boards permit the firing of a hardware interrupt upon reception of a specific CAN message, you can replace the timer interrupt line in the kernel by the interrupt line assigned to a CAN board. This leads to a CAN-message-driven execution of the target application.

To set this up, two independent steps are necessary:

- 1 Replace the timer interrupt line in the kernel setup with the board's hardware interrupt line.
- 2 Properly set up the CAN Setup and CAN Receive blocks.

Both steps are slightly different for each of the three supported CAN boards. Therefore the two steps are explained for each board type below.

### CAN-AC2 (ISA)

The CAN-AC2 is an ISA board, and the hardware interrupt line is set by means of hardware jumpers on the board. Refer to the Softing user manual for the board on how to set a certain interrupt line. Select an interrupt line that is not used by any other hardware device in the xPC Target system (for example by the Ethernet card).

- 1 In the Simulink window, and from the **Tools** menu, point to **Real-Time Workshop**, and then click **Options**.

The Configuration Parameters dialog box is displayed.

- 2 Click the **Real-Time Workshop** node.
- 3 Ensure that in the **Target selection** section, the **RTW system target file** field is set to `xpctarget.tlc`.

- 4 Select the **xPC Target options** node.
- 5 In the **Real-time interrupt source** field, select the interrupt line number that you have set using the jumpers on the board.
- 6 Click **OK** and save the model.
- 7 Open the dialog box of the CAN Receive block in the model that defines the CAN message (identifier) to be used to fire the interrupt. Select the **Generate interrupts** check box. Selecting this box declares all CAN messages defined in this Receive block instance through their identifiers as messages that fire an interrupt. In other words, it is not possible to define a single CAN message within the set of defined identifiers to be the only one to fire an interrupt. In most cases only the reception of one specific message is used to drive the application execution. Therefore use at least two instances of the Receive block. One to receive the CAN message that drives the execution (Generate Interrupts selected) and the other for all other normal CAN messages to be received (Generate Interrupts cleared).

### CAN-AC2-PCI

The CAN-AC2 is a PCI board, and the hardware interrupt line is automatically assigned by the PCI BIOS during the initialization of the target system. Use the xPC Target function `getxpcpci` (see `help getxpcpci`) at the MATLAB command prompt to query the target system for installed PCI devices and the assigned resources. Write down the interrupt line number assigned to the CAN-AC2-PCI board.

- 1 In the Simulink window, and from the **Tools** menu, point to **Real-Time Workshop**, and then click **Options**.  
  
The Configuration Parameters dialog box is displayed.
- 2 Click the **Real-Time Workshop** node.
- 3 Ensure that in the **Target selection** section, the **RTW system target file** field is set to `xpctarget.tlc`.
- 4 Select the **xPC Target options** node.

- 5 In the **Real-time interrupt source** field, select the interrupt line number that you retrieved with the `getxpcpci` command.
- 6 Click **OK** and save the model.
- 7 Open the dialog box of the CAN Receive block in the model that defines the CAN message (identifier) to be used to fire the interrupt. Select the **Generate interrupts** check box. Selecting this box declares all CAN messages defined in this Receive block instance through their identifiers as messages that fire an interrupt. In other words, it is not possible to define a single CAN message within the set of defined identifiers to be the only one to fire an interrupt. In most cases only the reception of one specific message is used to drive the application execution. Therefore use at least two instances of the Receive block. One to receive the CAN message that drives the execution (Generate Interrupts selected) and the other for all other normal CAN messages to be received (Generate Interrupts cleared).

## **CAN-AC2-104 (PC/104)**

The CAN-AC2-104 is an ISA board (PC/104), and the hardware interrupt line is set by means of a software setting within the CAN Setup driver block. Note a free interrupt line that is not used by any other hardware device in the xPC target system (for example by the Ethernet card).

- 1 In the Simulink window, and from the **Tools** menu, point to **Real-Time Workshop**, and then click **Options**.  
  
The Configuration Parameters dialog box is displayed.
- 2 Click the **Real-Time Workshop** node.
- 3 Ensure that in the **Target selection** section, the **RTW system target file** field is set to `xpctarget.tlc`.
- 4 Select the **xPC Target options** node.
- 5 In the **Real-time interrupt source** field, select the free interrupt line number that you chose.
- 6 Click **OK** and save the model.

- 7 In the model open the dialog box of the CAN Setup block for the CAN-AC2-104 board. Select the chosen interrupt line in the **Interrupt Line** pop-up menu and close the dialog box. Open the dialog box of the CAN Receive block in the model that defines the CAN message (identifier) to be used to fire the interrupt. Select the **Generate interrupts** check box. Selecting this box declares all CAN messages defined in this Receive block instance through their identifiers as messages that fire an interrupt. In other words, it is not possible to define a single CAN message within the set of defined identifiers to be the only one to fire an interrupt. In most cases only the reception of one specific message is used to drive the application execution. Therefore use at least two instances of the Receive block. One to receive the CAN message that drives the execution (Generate Interrupts selected) and the other for all other normal CAN messages to be received (Generate Interrupts cleared).

After you complete these two steps, you are ready to build the model. After the downloading has succeeded and the target application execution has been started, the execution is now driven by the selected CAN messages. The execution time information displayed on the target screen is now directly dependent on the reception of the corresponding message. If no message is received the time does not advance. You should ensure that the corresponding CAN message on the other CAN node is only generated if the xPC target application is running, otherwise unexpected interrupt messages might be displayed on the target screen.



## Defining Initialization and Termination CAN Messages

The CAN Setup driver blocks for all supported CAN boards allow the definition of CAN messages to be sent during initialization and termination of the target application (once at the beginning of each application run and once before an application run is stopped). The main purpose for sending these messages is to initialize or terminate other CAN nodes on the network. This is the case, for example, for CANOpen or DeviceNet nodes. Even if xPC Target does not provide direct support of those CAN application layers, communication with those nodes can usually be done over standard CAN messages as long as the nodes have been properly initialized. The initialization and termination fields of the Setup blocks are intended for this purpose.

You define the initialization and termination CAN messages using MATLAB struct arrays with CAN specific field names. This is the same concept as used for the RS-232, GPIB, and general Counter driver blocks found in the xPC Target I/O library. Refer to those driver blocks and their help for additional information about this basic concept.

The CAN Setup block-specific field names are the following:

**Port** — Selects the CAN port over which the message is sent. Valid values are either 1 or 2 (double).

**Type** — Defines whether the message to be sent is of type standard or extended. Valid values are either 'Standard' or 'Extended' (strings).

**Identifier** — Defines the identifier of the message. The value (scalar) itself must be in the corresponding identifier range (standard or extended).

**Data** — Defines the data frame to be sent out along with the CAN message. The value must be a row vector of type double with a maximum length of 8. Each element of the vector defines one byte, where the first element defines the data for byte 0 and the eighth element the data for byte 7. Each element can have a value between 0 and 255 (decimal). The data frame size is defined by the length of the row vector.

**Pause** — Defines the amount of time in seconds the Setup block waits after this message has been sent and before the next message defined in the struct array is parsed and sent. Valid values are between 0 and 0.05 seconds. Some CAN nodes need some time to settle before they can accept the next message, especially when the message just received puts the node in a new operational mode. Use this field to define those necessary idle times.

### Example

Consider an A/D converter module with a CANOpen interface. After the node is powered up, the module is in preoperational mode, which is common for CANOpen nodes. At least two initialization messages must be sent to the node to make the module fully operational.

The first message puts the node from preoperational into operational mode. The second message programs the module so that each time the converted A/D value differs by more than 10 mV from the former conversion, a CAN message is automatically sent, with the converted value as the data frame.

After the target application starts and the node is properly initialized, the node automatically sends a CAN message, which the xPC target application receives and then processes.

Before the target application execution is actually stopped, the module (node) must be returned to preoperational mode. You do this by sending out one corresponding termination message.

The initialization and termination message struct for this example could look as follows:

```
% put node into operational mode
init(1).port=1;
init(1).type='Standard';
init(1).identifier=1536+11;
init(1).data=[hex2dec('22'),hex2dec('23'),hex2dec('64'),hex2dec(
    '00'),hex2dec('01')];
init(1).pause=0.02;

% program node to send CAN messages with converted A/D values
automatically
init(2).port=1;
init(2).type='Standard';
init(2).identifier=0;
init(2).data=[hex2dec('01'),11];
init(2).pause=0;

% put node back into preoperational mode
term(1).port=1;
term(1).type='Standard';
```

## CAN-AC2 and CANopen Devices

xPC Target CAN-AC2 supports CAN specification 2.0a and 2.0b but this does not generally include the CANopen protocol on driver level. Nevertheless it is possible to access CANopen devices by the CAN-AC2 drivers in a general way.

CANopen knows two types of messages i.e. SDO and PDO. SDOs are used to setup or initialize a CANopen device for a certain behavior. PDOs are messages that contain real-time data (i.e. converted A/D values from a analog input device) and are CAN-type messages with no CANopen object, index, and subindex information.

xPC Target applications that have to access CANopen devices over the CAN-AC2 drivers transmit SDOs during the initialization phase and the termination phase of the driver. PDOs are sent or received during the simulation phase of the driver.

Because SDOs and PDOs are regular CAN-messages the CAN-AC2 drivers have to provide a way to transmit SDOs during the initialization and termination phase of the CAN-AC2 set up driver block to initialize the different CANopen devices in the network. This is done by providing a c-file within your project directory that describes the SDO messages to send to setup and terminate the CANopen device. During the compilation stage of the xPC Target application (build-process) this c-file, which has to have the filename `CANAC2_setup.c`, is then included into the setup driver.

This implementation has the advantage of accessing a specific CANopen device without the need to have special driver blocks for this device. It is, therefore, a general implementation but has the disadvantage that the user must be able to provide the information (messages) to properly set up and terminate the communication with a specific CANopen device. This information is provided either by the CANopen device manufacturer or by the CAN-CIA association ([www.can-cia.de](http://www.can-cia.de)).

For an explanation of how to write the `CANAC2_setup.c` file for a specific CANopen device, see the example below. In this example an analog input device from Selectron ([www.selectron.ch](http://www.selectron.ch)) with the name AIC711 is used to get the A/D-converted values over the CAN-network into the xPC Target application.

---

**Note** CANopen initialization and termination is only supported if the CAN-AC2 board is equipped with the Philips C200 controller for standard identifiers.

---

### **Example: Accessing the AIC711 CANopen Device from Selectron**

The AIC711 contains four analog input channels with a resolution of 12bits and a minimal update-time (sample time) of 10ms.

As explained in earlier chapters, the CAN-AC2 drivers use the dynamic object model to reach low latency times. Therefore the A/D values from the AIC711 have to be received in such a way that they are compatible to the object model of the driver.

The AIC711 has to be seen as a CANopen server and the xPC Target CAN-AC2 drivers (the xPC Target application) as a CANopen client. The AIC711 offers two ways of getting the converted A/D-values over the network:

- Synchronous
- Asynchronous

In the synchronous mode, the client transmits a remote frame to the server to invoke an A/D-conversion of a specified channel. It then waits (poll) until the converted value is received by an ordinary CAN data-message which will contain the values. Synchronous mode leads to large latency times up to 20ms ( $T_{smin}=10ms$ ). During this time period, the xPC Target gets stuck and this is unacceptable.

In addition, the synchronous mode does not fit into the dynamic object model implementation of the xPC Target CAN-drivers because remote frames have to be transmitted.

In the asynchronous mode, the AIC711 sends PDOs automatically in a regular manner to the client. A change in an analog input value invokes automatically an A/D-conversion. After conversion, a PDO-message is constructed and sent automatically to the client. This mode fits well into the object model of the drivers. Therefore the CANopen devices should always be used in asynchronous mode if used with xPC Target.

Regarding the information in the AIC711 CANopen manual (provided by Selectron), the following initialization messages (SDOs) and termination messages (SDOs) must be invoked:

- **Initialization phase** — Enable global interrupts to enable asynchronous mode (object 6423). Put device from preoperational mode into operational mode (transmission of PDOs starts).
- **Simulation phase** — CAN-AC2 Receive block outputs the latest received A/D values.
- **Termination phase** — Put device from operational mode into preoperational mode (transmission of PDOs stops)

The node id of the AIC711 device is set over DIP-switches and, in this example, it is assumed that the node id is set to 11 (decimal). The device is connected to CAN-port 1 of the CAN-AC2-board.

Then the CANAC2\_setup.c file could look as follows

```

////////////////////////////////////
// Number of initialization and termination messages
////////////////////////////////////
#define CANAC2_init_number2
#define CANAC2_term_number1
//#define DEBUG_CANAC2

// do not change the following four lines
#define CANAC2_setup_present
CANAC2_type CANAC2_init[CANAC2_init_number+1];
CANAC2_type CANAC2_term[CANAC2_term_number+1];
int CANAC2_counter;
//

////////////////////////////////////
// Identifier and constant section
////////////////////////////////////

#define AIC711_node_111
#define AIC711_sdo_base1536
#define MAS_boot 0

```

```
//
// Initialization section
//

// AIC711 SDO object 6423: enable global interrupts
CANAC2_init[0].port=1;
CANAC2_init[0].identifier=AIC711_sdo_base+AIC711_node_1;
CANAC2_init[0].data[0]=0x22;
CANAC2_init[0].data[1]=0x23;
CANAC2_init[0].data[2]=0x64;
CANAC2_init[0].data[3]=0x00;
CANAC2_init[0].data[4]=0x01;
CANAC2_init[0].no_bytes=5;
CANAC2_init[0].wait_ms=20;

// put AIC711_node_1 from pre-operational into operational state
CANAC2_init[1].port=1;
CANAC2_init[1].identifier=MAS_boot;
CANAC2_init[1].data[0]=0x01;
CANAC2_init[1].data[1]=AIC711_node_1;
CANAC2_init[1].no_bytes=2;
CANAC2_init[1].wait_ms=20;

//
// Termination section
//

// put AIC711_node_1 from operational into pre-operational state
CANAC2_term[0].port=1;
CANAC2_term[0].identifier=MAS_boot;
CANAC2_term[0].data[0]=0x80;
CANAC2_term[0].data[1]=AIC711_node_1;
CANAC2_term[0].no_bytes=2;
CANAC2_term[0].wait_ms=20;
```

As soon as this file is placed into your project directory and the xPC Target application is rebuilt, the messages defined above will be sent during initialization and termination phase of the Setup block.

The Simulink model could look as follows

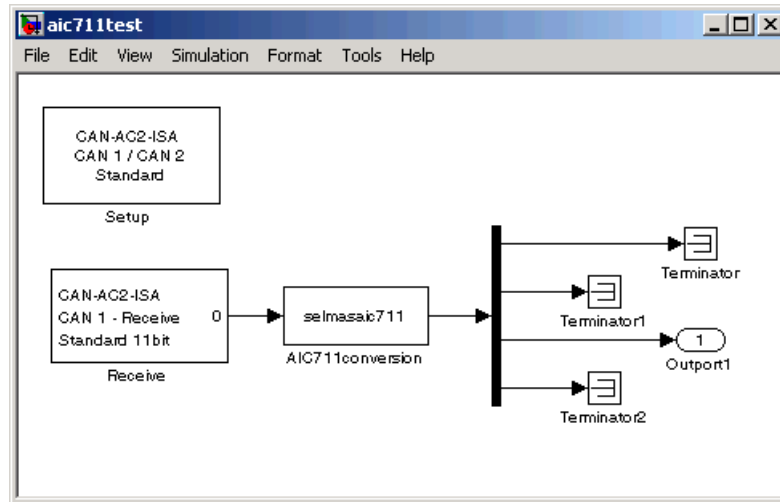

The Receive block will read continuously the object to which the AIC711 sends the PDOs (i.e. the converted A/D-values).

Because the output of this block contains the 8 bytes of the received CAN-data as a double value, a conversion block (AIC711conversion) is necessary to split the 8 bytes (double) into 4 doubles (output signals) that represent the A/D value in volts for each of the four analog input channels. The conversion is made according to the data representation of object 6401. You use the CAN bit-unpacking block from the CAN Utilities library. For example, in the CAN bit-unpacking block, set the **Data types** parameter to four vectors of int16 data types:

```
{'it16' 'int16' 'int16' 'int16'}
```

In the same block, set the **Bit patterns** parameter to

```
{[0:15] [16:31] [32:47] [48:63]}
```

You then need to multiply the output by the voltage range, which you should already know. Note that you may need to convert the output to type double first.

The third channel is then stored with an output block, which can be visualized by the xPC Target scope functionality.

Because CAN-messages with id 0 (boot) and  $1536 + \text{node\_id}$  (SDO) have to be sent and CAN-messages with id  $640 + \text{node\_id}$  (PDO) have to be received over CAN-port 1, the dialog box of the Setup block must look as follows:

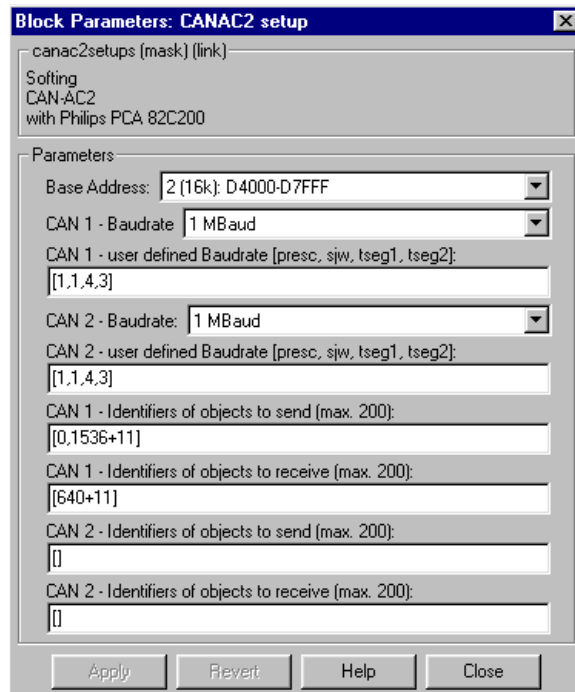

The Receive block receives the data (PDO) over CAN-message  $640 + \text{node\_id}$  and must look as follows:



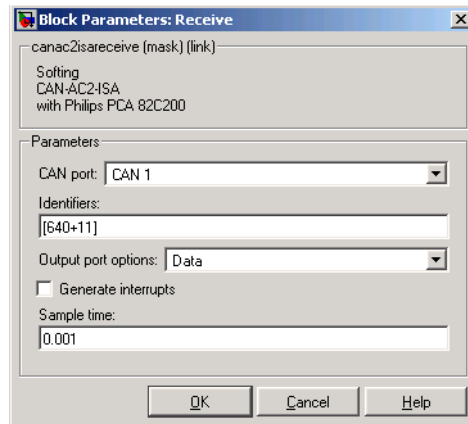

If more than one CANopen device is connected to the network, the dialog boxes of the Setup and Receive blocks and the `CANAC2_setup.c` file have to be extended accordingly. If you need for-loops in the `CANAC2_setup.c`, use the variable `CANAC2_counter`.

If an analog output device (or digital output device) is connected to the network, you must drag an additional Send block into the model to send the PDOs to the newly connected CANopen server.



# CAN I/O Support for FIFO

---

This chapter includes the following sections:

Introduction (p. 5-2)

This chapter describes the alternative First In First Out (FIFO) CAN drivers provided with xPC Target.

CAN FIFO Driver Blocks for the  
CAN-AC2-PCI with Philips SJA1000  
CAN Controller (p. 5-6)

The driver blocks described here support the  
CAN-AC2-PCI using FIFO mode.

CAN FIFO Driver Blocks for the  
CAN-AC2-104 with Philips SJA1000  
CAN Controller (p. 5-22)

The driver blocks described here support the  
CAN-AC2-104 (PC/104) using FIFO mode.

Acceptance Filters (p. 5-38)

The CAN controller's acceptance filters can be used to  
ensure that certain received messages referenced by their  
identifiers get written into the receive FIFO.

Examples (p. 5-40)

Examples involving FIFO CAN drivers.

## Introduction

This chapter describes the alternative First In First Out (FIFO) CAN drivers provided with xPC Target. The standard CAN drivers for the CAN boards from Softing GmbH (<http://www.softing.com>) program the CAN board firmware to run in Dynamic Object Buffer (DOB) mode. This mode is best suited for real-time environments where it is mandatory that the driver latency time is time deterministic. Actually, running the firmware in Dynamic Object Buffer mode is always the best choice except for the undesired side effect of high driver latency times.

- **Sending a CAN message** — When sending a CAN message, the latency time is the time interval between the time accessing the board to provide all the information for the CAN message to be sent and the time the board returns the acknowledgment that the information has been received by the firmware.
- **Receiving a CAN message** — When receiving a CAN message, the latency time is the time interval between the time accessing the board to ask for current data (object data) of a certain CAN identifier and the time the board returns the actual data and other information about the CAN message.

**Disadvantages of Dynamic Object Buffer mode** — These latency times are mainly defined by the reaction time of the board firmware. In the case of the Softing boards, the latency time is the same for sending and receiving messages, with a fixed value of about 40  $\mu$ s. If your xPC Target application has to send and receive a large number of CAN messages, the overall latency time can quickly become high and can make it impossible to run the application at the desired base sample time.

For example, assuming that a specific xPC Target application gets data from 12 CAN identifiers and transmits data by using eight CAN messages, the total number of CAN board read and write accesses adds up to 20. This results in a total CAN I/O latency time of

$$20 * 40 \mu\text{s} = 800 \mu\text{s}$$

With such an application, base sample times below 800  $\mu$ s are impossible even if the dynamics of the corresponding Simulink model are simple and would only need 20  $\mu$ s of computation time.

**Advantages of Dynamic Object Buffer mode** — However, even if the CAN I/O latency time in Dynamic Object Buffer mode is high, the benefit of this mode is that the latency time stays constant almost independent of the traffic volume on the CAN network. This means that the Dynamic Object Buffer mode is best suited for xPC Target applications that only deal with a small subset of all CAN messages going over the CAN network.

## **FIFO Mode Drivers for CAN Boards from Softing**

The CAN boards from Softing support another mode, called First In First Out (FIFO) mode. In this mode the Dynamic Object Buffer mode abstraction layer in the firmware is missing, and the firmware plays the role of a slim interface between the receive and transmit FIFOs and the drivers in the application code. Because of this slimmer interface, the I/O latency times are considerably smaller. Writing to the transmit FIFO takes 4  $\mu$ s per CAN message and reading one event (CAN message) from the receive FIFO takes 17  $\mu$ s. Both of these latency times are smaller than the 40  $\mu$ s for Dynamic Object Buffer mode. While writing to the transmit FIFO is efficient, this is not the case for reading from the receive FIFO. Because the receive FIFO is filled with all CAN messages (identifiers) going over the CAN network, there can be a lot of data (CAN messages) that have to be read out of the FIFO even if their data is not used in the target application. Because of the FIFO structure, all events (messages) have to be read until the message is returned that is propagated to the target application. The driver code for reading the receive FIFO is principally a while loop, and this can add the problem of non-deterministic latency times.

You resolve the latency time issue in the xPC Target CAN FIFO drivers by defining a receive FIFO read depth that is a constant number during application execution. For example, if you assume a FIFO read depth of 5, each time the Read Receive FIFO driver block is executed at the block sample time, the driver code reads and returns five events (messages) from the receive FIFO. This is independent of how many events the FIFO currently contains. There can be only two messages received in the FIFO and the third to fifth read attempt might just return the “No new event” code. Nevertheless, because the FIFO read latency does not exceed 17  $\mu$ s regardless of the event read out of the FIFO, the latency time becomes deterministic and is the Read FIFO Depth multiplied by 17  $\mu$ s. The driver block returns all new events and therefore all CAN messages going over the network. If only a small subset of the CAN messages received must be processed in the target application, the total latency

can easily exceed the latency encountered with the Dynamic Object Buffer mode for the same application. There is another restriction specific to the FIFO mode concept. Using more than one Read Receive FIFO block in a Simulink model is not recommended, because a new event (message) read by one block instance cannot be read again by another block instance (the event is no longer in the FIFO buffer). Therefore the entire CAN receive part has to be concentrated in one Read Receive FIFO block in your model. For the write transmit FIFO side, this restriction does not apply. Here you can use as many instances as you want.

The Setup block for the CAN FIFO mode controls the CAN acceptance filters of the CAN controller. The acceptance filter defines a range of CAN messages not to be forwarded to the receive FIFO. Filtering out unwanted CAN messages can drastically reduce the read receive FIFO latency time because the unwanted messages do not reach the receive FIFO. Unfortunately, the acceptance filter process uses binary evaluation, which does not allow filtering messages below and above a certain decimal range. Therefore the use of the acceptance filter only resolves the problem for a small subset of CAN network applications. See “Acceptance Filters” on page 5-38 for more information on this.

Look again at the example of 12 messages to be received and eight messages to be transmitted. If those 20 messages with their specific identifiers are the only messages going over the CAN network (100% usage ratio) the total latency time is

$$12 \cdot 17 \text{ } \mu\text{s} + 8 \cdot 4 \text{ } \mu\text{s} = 236 \text{ } \mu\text{s}$$

This is a considerable smaller value than the 800  $\mu\text{s}$  that results when you use Dynamic Object Buffer mode drivers.

For the next case, assume that there are 12 additional messages going regularly over the network that do not need to be processed by the target application. Additionally, assume that those messages cannot be filtered by the CAN controller acceptance filter. Then the total latency time increases to

$$12 \cdot 17 \text{ } \mu\text{s} + 20 \cdot 4 \text{ } \mu\text{s} = 284 \text{ } \mu\text{s}$$

There is no impact on the final result. That is the tradeoff. Therefore the FIFO mode drivers are best suited for either CAN network monitoring applications or low-latency CAN applications where the ratio between the number of messages to be processed and the number of total messages going over the network is high.

FIFO mode drivers are especially suited for monitoring type applications, because FIFO mode can return additional information such as the bus state or the reception of error frames. Dynamic Object Buffer mode drivers do not allow querying such information.

This documentation only covers the differences between the Dynamic Object Buffer mode drivers (standard drivers), and the FIFO mode drivers introduced here. It assumes that you are familiar with the Dynamic Object Buffer mode drivers and have successfully run one of the loop-back tests provided with xPC Target.

If you use FIFO mode drivers in your model, you must replace all Dynamic Object Buffer mode blocks (Setup, Send, Receive) with FIFO mode driver blocks. The CAN-AC2-xxx boards from Softing do not let you run the two CAN ports in different modes. Therefore the mode has to be same for both ports, but you can use more than one CAN board and run the boards in different modes just by selecting the correct I/O driver blocks.

As mentioned in the standard CAN chapter, you should not use the CAN-AC2 (ISA) for new projects. Instead use the CAN-AC2-PCI. Therefore, FIFO mode drivers are only provided for the CAN-AC2-PCI and the CAN-AC2-104 boards.

## CAN FIFO Driver Blocks for the CAN-AC2-PCI with Philips SJA1000 CAN Controller

The driver blocks described here support the CAN-AC2-PCI using FIFO mode. The Philips SJA1000 chip is used as the CAN controller in this configuration and supports both standard and extended identifier ranges in parallel. The driver block set for this board is found in the xPC Target I/O block library in the group CAN/Softing.

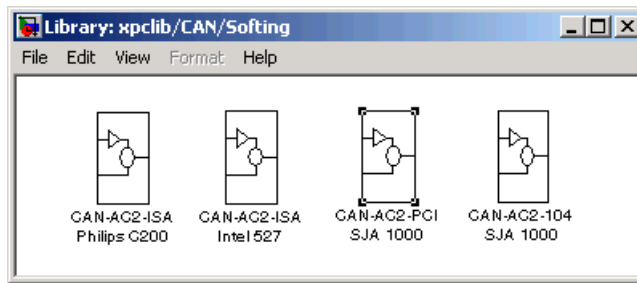

The third block group, CAN-AC2-PCI SJA 1000, contains the FIFO mode subgroup.

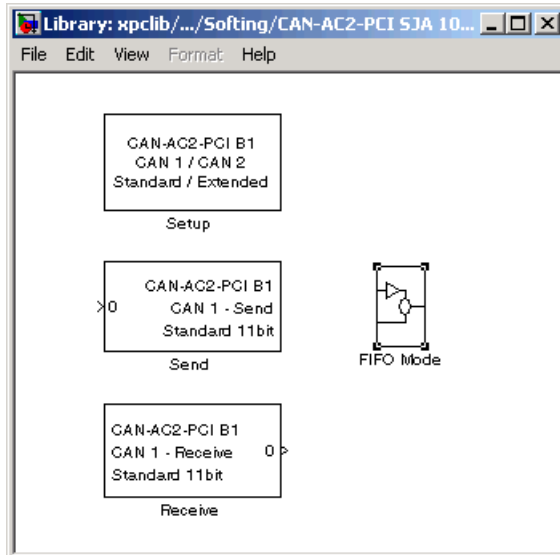



The highlighted group contains all driver blocks available for FIFO Mode CAN.

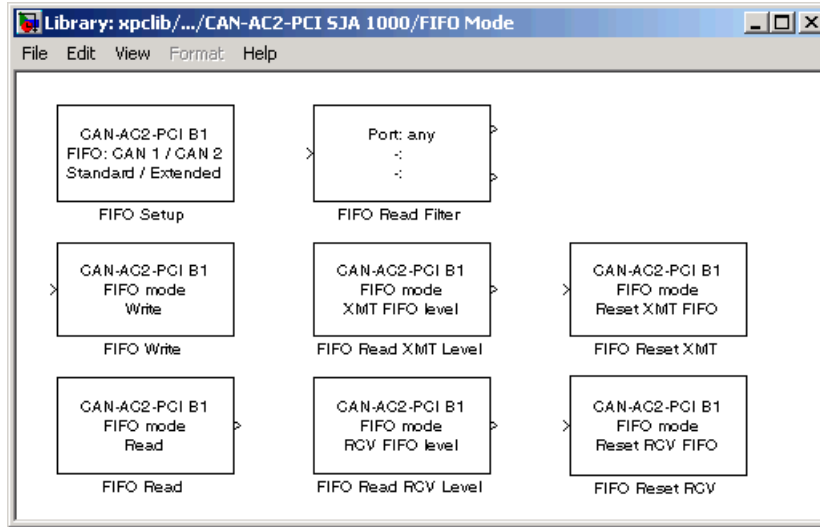

## FIFO Setup Driver Block

The Setup block defines general settings of the installed CAN board(s). The CAN driver blocks for this board support up to three boards for each target system, making up to six CAN ports available. For each board in the target system, you can use one Setup block in a model.

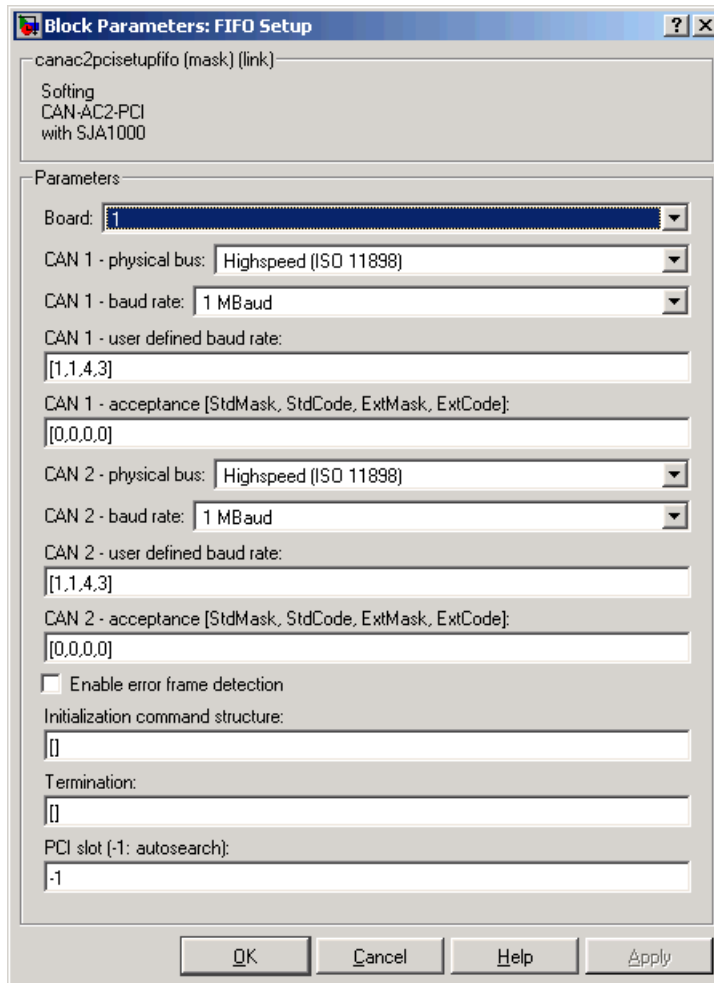

**Board** — Defines the board being accessed by this driver block instance. If multiple boards are present in the target PC, you can use the board number (1...3) to differentiate the boards. The physical board referenced by the board number depends on the **PCI Slot** parameter. If just one board is present in the target system, select board number 1.

**CAN 1 - physical bus** — Defines the physical CAN bus type of CAN port 1. In the board's standard hardware configuration, only high-speed CAN is

supported. By extending the board with low-speed CAN piggyback modules, you can also select low-speed CAN as the physical bus. Do not change this value to low-speed if no module is present for the corresponding CAN port. If the module is present (see the Softing user manual on how to install the modules), you can select between high-speed and low-speed CAN here.

**CAN 1 - baud rate** — Defines the most common baud rates for CAN port 1. If special timing is necessary (baud rate), select `User defined`.

**CAN 1 - user defined baud rate** — If you select `User defined` from the CAN 1 Baud rate list, enter the four values for the timing information. The vector elements have the following meanings:

```
[ Prescaler, Synchronization-Jump-Width, Time-Segment-1,  
  Time-Segment-2 ]
```

For more information about these values, see the Softing user manual for this board.

**CAN 1 - acceptance** — Defines the acceptance filters for the CAN 1 port. Because the receive FIFO is filled with any CAN messages going over the bus, the use of the CAN controller acceptance filters becomes important to filter out unwanted messages already at the controller level. This acceptance filter information is provided by a row vector with four elements in which the first two are used to define the acceptance mask and acceptance code for standard identifiers and the latter two for extended identifiers. The default value defined by the Setup block does not filter out any messages. For information on how to define the acceptance information to filter certain messages, see “Acceptance Filters” on page 5-38.

**CAN 2 - physical bus** — Defines the physical CAN bus type of CAN port 2. In the board’s standard hardware configuration, only high-speed CAN is supported. By extending the board with low-speed CAN piggyback modules, you can also select low-speed CAN as the physical bus. Do not set this value to low-speed if no module is present for the corresponding CAN port. If the module is present (see the Softing user manual on how to install the modules), you can select between high-speed and low-speed CAN here.

**CAN 2- baud rate** — Defines the most common baud rates for CAN port 2. If special timing is necessary (baud rate), select `User defined`.

**CAN 2 - user defined baud rate** — If you select User defined from the CAN 2 baud rate list, enter the four values for the timing information. The vector elements have the following meanings:

```
[ Prescaler, Synchronization-Jump-Width, Time-Segment-1,  
  Time-Segment-2 ]
```

For more information about these values, see the Softing user manual for this board.

**CAN 2 - acceptance** — Defines the acceptance filters for the CAN 2 port. Because the receive FIFO is filled with any CAN messages going over the bus, the use of the CAN controller acceptance filters becomes important to filter out unwanted messages already at the controller level. This acceptance filter information is provided by a row vector with four elements in which the first two are used to define the acceptance mask and acceptance code for standard identifiers and the latter two for extended identifiers. The default value defined by the Setup block does not filter out any messages. For information on how to define the acceptance information to filter certain messages, see “Acceptance Filters” on page 5-38.

**Enable error frame detection** — If the CAN controller should detect error frames and forward these to the Receive FIFO, select this box. Selecting this box makes sense for monitoring applications where you want to be informed about all events going over the bus. For low-latency time applications, selecting this box might increase the FIFO Read driver block latency time because the receive FIFO gets filled with additional events.

**Initialization (struct) and Termination (struct)** — Define the CAN messages sent during initialization and termination of the Setup block. For more information, see the standard CAN driver documentation in “Defining Initialization and Termination CAN Messages” on page 4-53.

**PCI Slot (-1: autosearch)** — Defines the PCI slot in which the referenced board (board number) resides. If only one CAN board is present in the target system, the value for this control should be -1 for autosearch. This value ensures that the xPC Target kernel automatically finds the board regardless of the PCI slot it is plugged into. If two or more boards of this type are physically present in the target PC, enter the bus number and the PCI slot number of the board associated with this driver block. Use the format [BusNumber, SlotNumber]. Use the xPC Target function `getxpcpci` to query the target system for installed

PCI boards and the PCI slots they are plugged into. For more information see `help getxpcpci`.

The board allows you to terminate each of the two CAN ports separately by means of DIP switches at the rear panel. Refer to the Softing user manual on how to set the DIP switches. Both CAN ports must be terminated properly if you use the loop-back model provided to test the board and drivers.

## FIFO Write Driver Block

The FIFO Write driver block is used to write CAN messages into the transmit FIFO. The firmware running in FIFO mode processes the information found in the transmit FIFO and finally puts the constructed CAN messages onto the bus.

The block has one input port of type double. At this port, all necessary information has to be provided to construct valid CAN messages to be written into the transmit FIFO. For each CAN message, five elements are passed:

```
Port
Identifier
Identifier type
Data frame size
Data
```

**Port** — The value can be either 1 (port 1) or 2 (port 2) and defines the port the CAN message is sent from.

**Identifier** — Identifier of the CAN message to be sent. If it is a standard CAN message the valid range is 0 to 2047. If the CAN message is extended, the range is 0 to  $2^{29}-1$ .

**Identifier type** — The value can be either 0 (standard identifier range) or 1 (extended identifier range) and defines the identifier type of the outgoing CAN message.

**Data frame size** — The value can be in the range of 0 to 8 and defines the data frame size in bytes of the outgoing CAN message.

**Data** — This is the data for the data frame itself and is defined as a double value (8 bytes). The CAN packing block is used to construct the data as a double value.

Because all this information can be dynamically changed in FIFO mode during application execution, the information is provided at the block input instead of you setting them through block parameters. To be able to transmit more than one CAN message per block instance, a matrix signal is used as a container for all information.

The dimension of the matrix signal entering the block has to be  $n \times 5$ , where  $n$  is the number of CAN messages to be sent by this block instance. Therefore each row of the matrix signal defines one CAN message and each row combines the five elements of information defined above (in this order).

For more on how to construct the correct matrix signal for the FIFO write block, see “Examples” on page 5-40.

For certain applications it might be necessary to make the writing of a CAN message into the transmit FIFO dependent on the model dynamics. For this case, the matrix signal can also be of dimension  $n \times 6$  instead of  $n \times 5$ . In this case, the sixth column defines whether the corresponding CAN message is written into the transmit FIFO (1) or not (0).

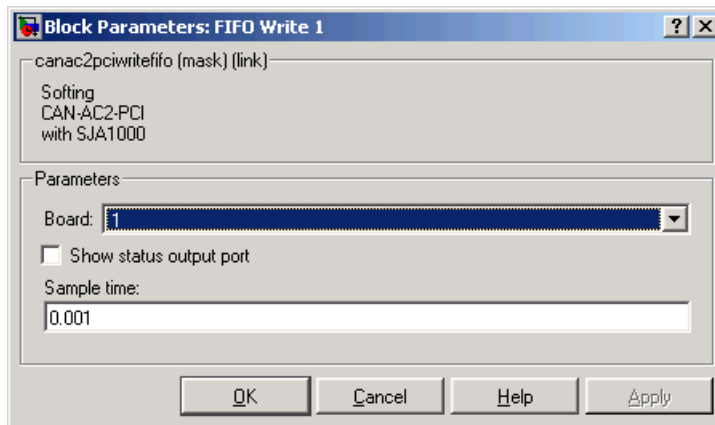

**Board** — Define the board used to send the CAN messages defined by this block instance. For more information about the meaning of the board number, see the Setup driver block described above. If just one board is present in the target system, you should select 1.

**Show status output port** — Select this box to enable the status output port. If the box is cleared, the block does not have an output port. If enabled, a port is

shown. The signal leaving the block is a vector of type double in which the number of elements depends on the signal dimension of the block input port. There is one element for each CAN message written into the transmit FIFO and the value is identical to the return argument of function `CANPC_send_data(...)`, described in the Softing user manual. Refer to that manual for more information.

**Sample time** — Defines the sample time at which the FIFO Write block is executed during a model (target application) run.

You can use as many instances of the FIFO Write block in the model as needed. For example, by using two instances of the block, you can send CAN messages at different sample times. Or you can use multiple instances to structure your model more efficiently.

## FIFO Read Driver Block

The FIFO Read driver block is used to read CAN messages from the receive FIFO. The firmware running in FIFO mode puts received events (CAN messages) into the receive FIFO from which the FIFO Read driver reads it.

The FIFO Read driver block has at least one output port of type double. The signal of this port is a matrix of size  $m \times 6$ , where  $m$  is the FIFO Read depth defined in the block dialog box (see below). For example, if the FIFO read depth is 5, then the matrix signal of port 1 has size  $5 \times 6$ . Therefore, one row for each event is read out of the receive FIFO (no new message is considered an event as well). For information on how to extract data from the matrix signal, see “Examples” on page 5-40.

Each row with its six elements contains all the information defining a CAN message:

```
Port
Identifier
Event type
Data frame size
Timestamp
Data
```

**Port** — The value can be either 1 (port 1) or 2 (port 2) and reports the port at which the CAN message was received.

**Identifier** — Identifier of the CAN message being received. If it is a standard CAN message the range is 0 to 2047. If it is an extended CAN message, the range is 0 to  $2^{29}-1$ .

**Event type** — This value defines the type of event read from the receive FIFO. The following values are defined in the Softing user manual.

- 0 No new event
- 1 Standard data frame received
- 2 Standard remote frame received
- 3 Transmission of a standard data frame is confirmed
- 4 -
- 5 Change of bus state
- 6 -
- 7 -
- 8 Transmission of a standard remote frame is confirmed
- 9 Extended data frame received
- 10 Transmission of an extended data frame is confirmed
- 11 Transmission of an extended remote frame is confirmed
- 12 Extended remote frame received
- 13 -
- 14 -
- 15 Error frame detected

**Data frame size** — If a data frame has been received, the length of the data in bytes is reported by this element. Possible values are 0 to 8.

**Timestamp** — Time at which the event was received. The resolution of the timestamp counter is 1  $\mu$ s.

**Data** — Data of the data frame itself returned as a double value (8 bytes). The CAN Unpacking block is used to extract the data from the double value.



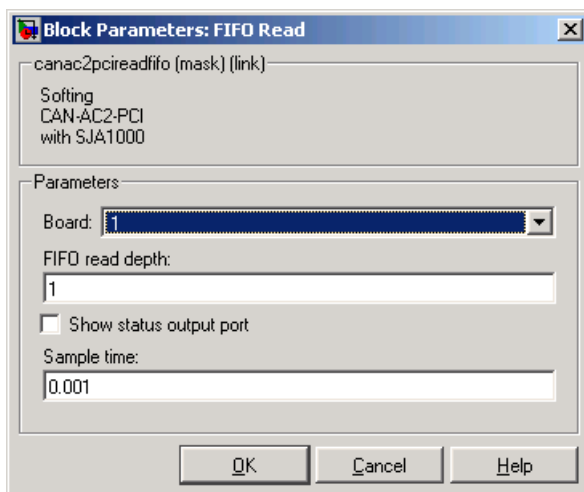

**Board** — Defines the board used to send the CAN messages defined by this block instance. For more information about the meaning of the board number, see the Setup driver block described above. If one board is present in the target system, select board number 1.

**FIFO read depth** — Defines the number of receive FIFO read attempts. Each time the block is executed it reads this fixed number of events (CAN messages), which lead to a deterministic time behavior regardless of the number of events currently stored in the receive FIFO. The Read depth ( $m$ ) also defines the size of the matrix signal ( $m*6$ ) leaving the first output port. If no event is currently stored in the receive FIFO, the FIFO is read anyway, but the event type is reported as 0 (no new event).

**Show status output port** — Select this box to enable the Status output port. If the box is cleared (disabled), the block has one output port for the events. If enabled, a second port is shown. The signal leaving that port is a vector of type double with two elements:

[Number of lost messages (events), Bus state]

The first element returns the current value of the lost messages counter. The receive FIFO can store up to 255 events. If the receive FIFO is not regularly accessed for reading events, the FIFO is filled and the lost messages counter starts to count up. This is an indicator that events (messages) will be unavoidably lost. The second element returns the current bus state. Possible values are

- 0 Error active
- 1 Error passive
- 2 Bus off

**Sample time** — Defines the sample time at which the FIFO Read block is executed during a model (target application) run.

It is strongly recommended that you use only one instance of this block per physical CAN board in your model. Otherwise you might get the unwanted behavior that one instance would read events that must be processed by blocks connected to the other, second instance.

### FIFO Read Filter Block

This is a utility block for the CAN FIFO driver block set, but does not actually access the CAN board or any other hardware device. This block is usually connected to the first output port of the FIFO Read driver block and allows filtering events out of the event matrix, the signal leaving the FIFO Read driver block.

The block code walks through the rows of the incoming event matrix signal and looks for events matching the criteria defined in the block dialog box. If it matches, the entire event information (row) is written to the block's first output port. If more than one row matches the criteria, the later event overwrites the earlier event.

The block has one input port and two output ports. The input port is of type double and accepts a matrix signal of size  $m \times 6$ . The two output ports are of type double as well. The first output is a row vector ( $1 \times 6$ ), the filtered event, and the second outputs a scalar value that reports the number of matching events the filter block has processed.

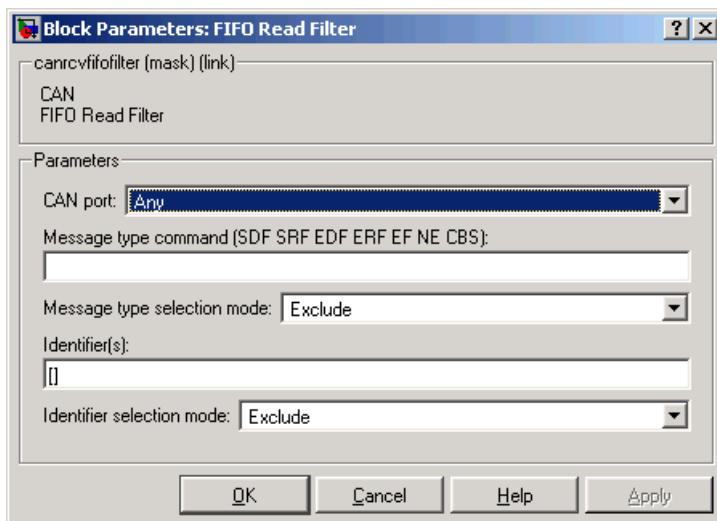

**CAN port** — Defines the filter criterion for the CAN port. From the list, select Any, 1, or 2.

**Message type command** — Defines the filter criterion for the event types. This entry can consist of a concatenation of space-delimited keywords that are

|     |                       |
|-----|-----------------------|
| SDF | Standard data frame   |
| SRF | Standard remote frame |
| EDF | Extended data frame   |
| ERF | Extended remote frame |
| EF  | Error frame           |
| NE  | No new event          |
| CBS | Change of bus state   |

**Message type selection mode** — Defines how the event type (message type), from the **Message type command** parameter, is treated. If you select Include, the event type criterion is the sum of the concatenated keywords. If you select Exclude, the event type criterion is equal to all event types minus the sum of the concatenated keywords.

**Identifier(s)** — Defines the filter criterion for the CAN message identifiers. A set of identifiers can be provided as a row vector.

**Identifier selection mode** — Defines how the identifier criterion, from the **Identifier(s)** parameter, is treated. If you select **Include**, the identifier criterion is the sum of all specified identifiers. If you select **Exclude**, the identifier criterion is equal to all identifiers minus the specified identifiers.

You can use as many instances of this block in your model as needed. Usually, you connect several instances in parallel to the output of the FIFO Read driver block to filter out particular messages or events. For more information on how to do this, see “Examples” on page 5-40.

### FIFO Read XMT Level Driver Block

The FIFO Read XMT Level driver block is used to read the current number of CAN messages stored in the transmit FIFO to be processed by the firmware. The transmit FIFO can store up to 255 messages. If it is full and a FIFO write driver block tries to add another message to the transmit FIFO, the passed messages are lost. You can use this driver block to check for this condition and take appropriate action. For example, you could stop the execution or wait for a nonfull transmit FIFO.

The block has a single output port of type double returning a scalar value containing the current transmit FIFO level (number of messages to be processed).

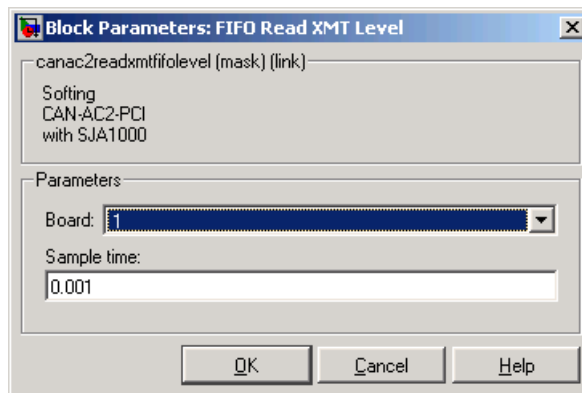

**Board** — Defines the board accessed to read the current transmit FIFO level. For more information about the meaning of the board number, see the Setup driver block described above. If just one board is present in the target system, select board number 1.

**Sample time** — Defines the sample time at which the FIFO Read XMT Level driver block is executed during a model (target application) run.

## FIFO Reset XMT Driver Block

The FIFO Reset XMT driver block is used to reset the transmit FIFOs. This deletes all messages currently stored in the transmit FIFO and reset the level counter to 0. As an example, you can use this driver block to reset the transmit FIFO after having detected a fault condition.

The block has a single input port of type double. If a scalar value of 1 is passed, the transmit FIFO is reset. If a scalar value of 0 is passed, no action takes place.

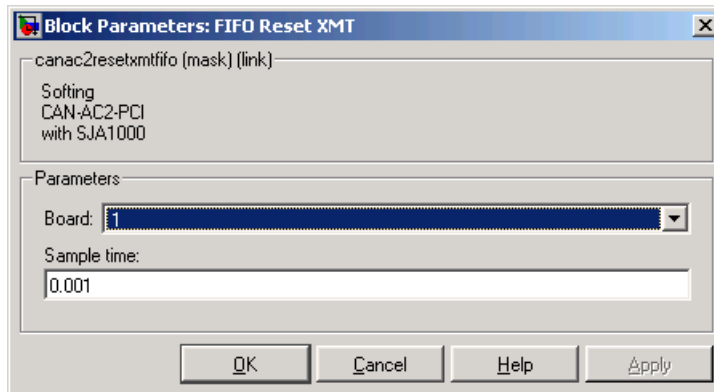

**Board** — Defines the board accessed to reset the transmit FIFO. For more information about the meaning of the board number, see the Setup driver block described above. If just one board is present in the target system, select board number 1.

**Sample time** — Defines the sample time at which the FIFO Reset XMT driver block is executed during a model (target application) run.

### FIFO Read RCV Level Driver Block

The FIFO Read RCV level driver block reads the current number of CAN messages stored in the receive FIFO. The receive FIFO can store up to 255 events (messages). If it is full and no FIFO read driver block attempts to read the stored events, new incoming events are lost, as shown by the lost message counter incrementing. You can use this driver block to check for this condition and take appropriate action, such as stopping the execution or resetting the receive FIFO.

The block has a single output port of type double returning a scalar value containing the current receive FIFO level (number of messages to be processed).

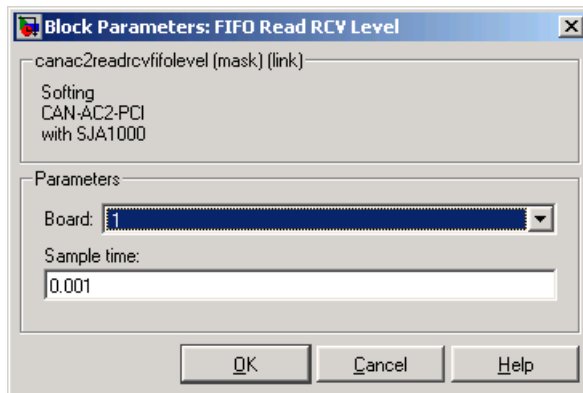

**Board** — Defines the board accessed to read the current receive FIFO level. For more information about the meaning of the board number, see the Setup driver block described above. If just one board is present in the target system, select board number 1.

**Sample time** — Defines the sample time at which the FIFO Read RCV Level driver block is executed during a model (target application) run.

## FIFO Reset RCV Driver Block

The FIFO Reset RCV driver block resets the receive FIFO. This deletes all messages currently stored in the receive FIFO and reset the level counter to 0. As an example, you can use this driver block to reset the receive FIFO after having detected a fault condition.

The block has a single input port of type double. If a scalar value of 1 is passed, the transmit FIFO is reset. If a scalar value of 0 is passed, no action takes place.

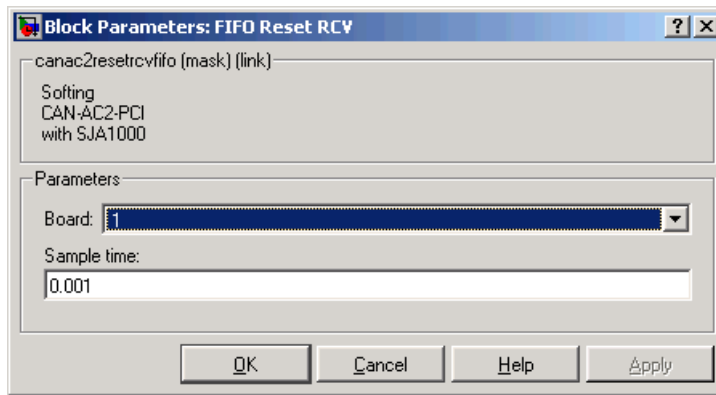

**Board** — Defines the board accessed to reset the receive FIFO. For more information about the meaning of the board number, see the Setup driver block described above. If just one board is present in the target system, select board number 1.

**Sample time** — Defines the sample time at which the FIFO Reset RCV driver block is executed during a model (target application) run.

## CAN FIFO Driver Blocks for the CAN-AC2-104 with Philips SJA1000 CAN Controller

The driver blocks described here support the CAN-AC2-104 (PC/104) using FIFO mode. The Philips SJA1000 chip is used as the CAN controller in this configuration and supports both standard and extended identifier ranges in parallel. The driver block set for this board is found in the xPC Target I/O block library in the group CAN/Softing.

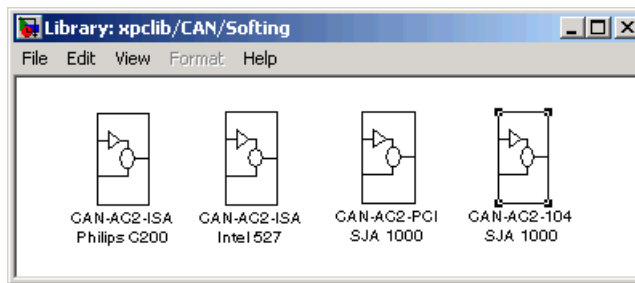

The fourth block group, CAN-AC2-104 SJA 1000, contains the FIFO Mode subgroup.

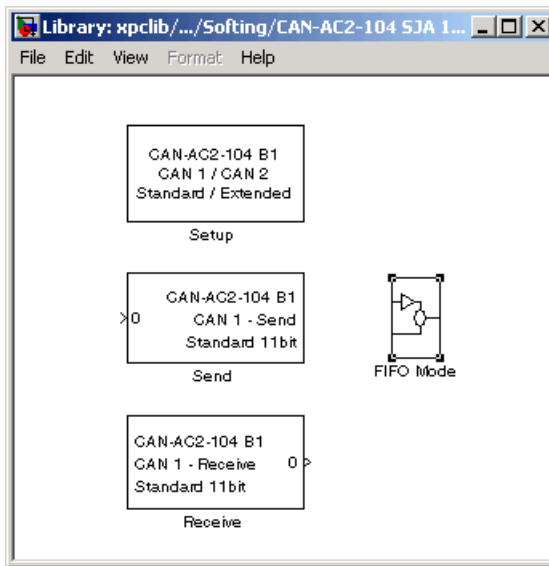



The highlighted group contains all the driver blocks available for FIFO mode CAN.

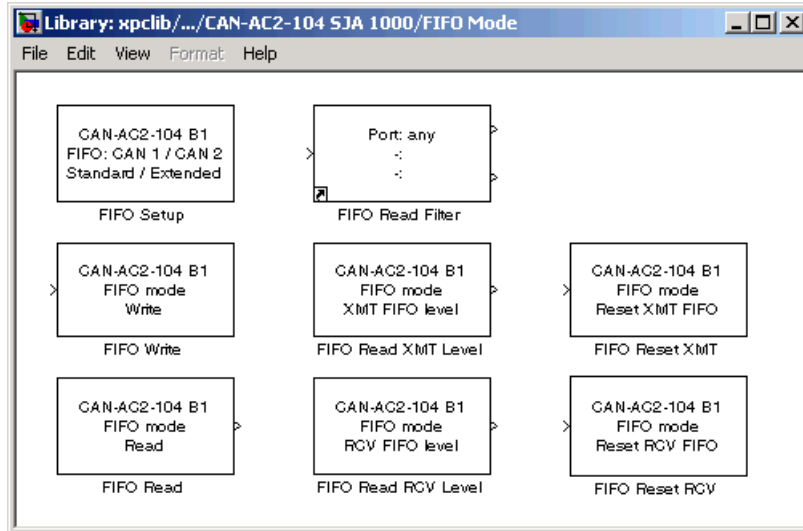

## FIFO Setup Driver Block

The FIFO Setup driver block defines general settings of the installed CAN boards. The CAN driver blocks for this board support up to three boards for each target system, making up to six CAN ports available. For each board in the target system, you must use exactly one Setup driver block.

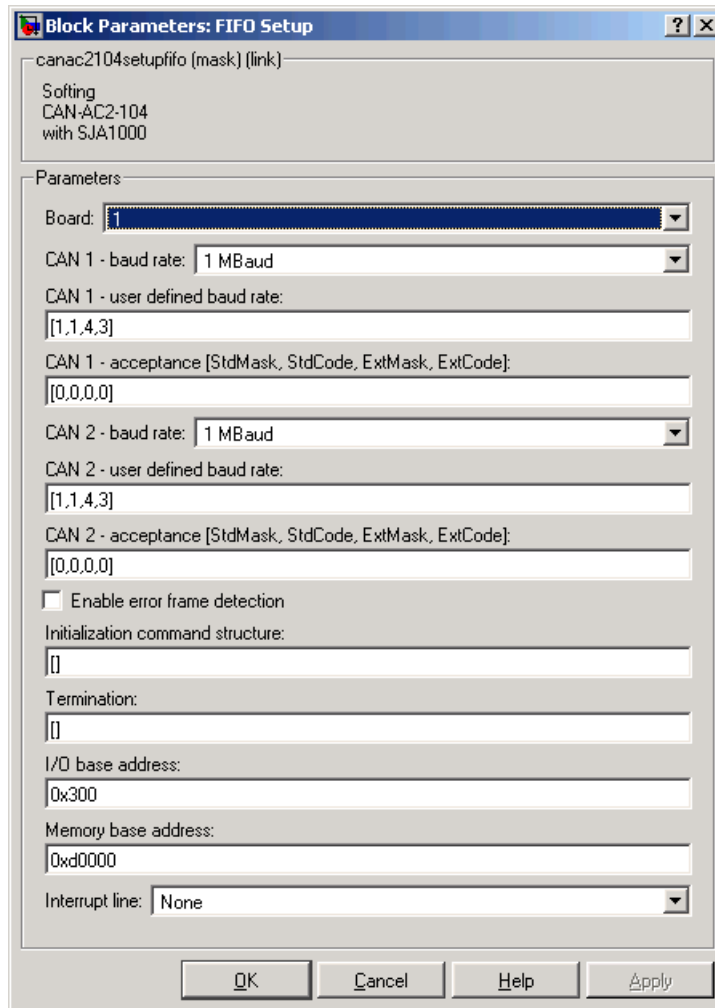

**Board** — Defines the board accessed by this driver block instance. If multiple boards are present in the target PC, you can use the board number (1...3) to differentiate the boards. The physical board referenced by the board number depends on the **PCI Slot** parameter. If just one board is present in the target system, select board number 1.

**CAN 1 - baud rate** — Defines the most common baud rates for CAN port 1. If special timing is necessary (baud rate), you can select `User defined`.

**CAN 1 - user defined baud rate** — If you selected `User defined` from the CAN 1 - baud rate list, enter four values for the timing information. The vector elements have the following meanings:

```
[ Prescaler, Synchronization-Jump-Width, Time-Segment-1,  
  Time-Segment-2 ]
```

For more information about these values, see the Softing user manual for this board.

**CAN 1 - acceptance** — Defines the acceptance filters for CAN port 1. Because the receive FIFO is filled with any CAN messages going over the bus, the use of the CAN controller acceptance filters becomes important to filter out unwanted messages already at the controller level. This acceptance filter information is provided by a row vector with four elements in which the first two are used to define the acceptance mask and acceptance code for standard identifiers and the latter two for extended identifiers. The default value defined by the Setup block does not filter out any messages. For information on how to define the acceptance information to filter certain messages, see “Acceptance Filters” on page 5-38.

**CAN 2 - baud rate** — Defines the most common baud rates for CAN port 2. If special timing is necessary (baud rate), you can select `User defined`.

**CAN 2- user defined baud rate** — If you selected `User defined` from the CAN 1 - baud rate list, enter four values for the timing information. The vector elements have the following meanings:

```
[ Prescaler, Synchronization-Jump-Width, Time-Segment-1,  
  Time-Segment-2 ]
```

For more information about these values, see the Softing user manual for this board.

**CAN 2 acceptance** — Defines the acceptance filters for CAN port 2. Because the receive FIFO is filled with any CAN messages going over the bus, the use of the CAN controller acceptance filters becomes important to filter out unwanted messages already at the controller level. This acceptance filter information is provided by a row vector with four elements in which the first two are used to define the acceptance mask and acceptance code for standard identifiers and the latter two for extended identifiers. The default value

defined by the Setup block does not filter out any messages. For information on how to define the acceptance information to filter certain messages, see “Acceptance Filters” on page 5-38.

**Enable error frame detection** — Defines whether the CAN controller should detect error frames and forward these to the receive FIFO. Selecting this box makes sense for monitoring applications where you want to be informed about all events going over the bus. For low-latency time applications, selecting this box might increase the FIFO Read driver block latency, because the receive FIFO is filled with additional events.

**Initialization command structure and Termination** — Defines CAN messages sent during initialization and termination of the Setup block. For more information, see Chapter 4, “CAN I/O Support.”

**I/O base address** — Defines the I/O base address of the board to be accessed by this block instance. The I/O base address is given by the DIP switch setting on the board itself. The I/O address range is 3 bytes and is mainly used to identify the memory base address the board should use. See the Softing user manual for this board on how you can set the I/O base address. The I/O base address entered in this control must correspond with the DIP switch setting on the board. If more than one board is present in the target system, you must enter a different I/O base address for each board. In this case, the I/O base address itself defines which board is referenced by which board number.

**Memory base address** — Defines the memory base address of the board to be accessed by this block instance. The memory base address is a software setting only (no corresponding DIP switch is found on the board). The memory address range is 4 KB. If more than one board is present in the target system, you must enter a different memory base address for each board and you must ensure that the defined address ranges do not overlap. Because the xPC Target kernel only reserves a subset of the address range between 64 KB and 1 MB for memory-mapped devices, the address ranges must lie within the following range:

C0000 - DC000

The board allows you to terminate each of the two CAN ports separately by means of DIP switches at the back panel of the board. Refer to the Softing user manual on how to set the DIP switches. Both CAN ports must be properly terminated before you can use the loop-back model provided to test the board and drivers.

**Interrupt line** — Select an interrupt line from the list.

## FIFO Write Driver Block

The FIFO Write driver block is used to write CAN messages into the transmit FIFO. The firmware running in FIFO mode then processes the information found in the transmit FIFO and finally puts the constructed CAN messages onto the bus.

The block has one input port of type double. At this port, you must provide all necessary needed to construct valid CAN messages to be written into the transmit FIFO. For each CAN message, five elements have to be passed:

Port  
Identifier  
Identifier type  
Data frame size  
Data

**Port** — The value can be either 1 (port 1) or 2 (port 2) and defines at which port the CAN message is sent from.

**Identifier** — Identifier of the CAN message to be sent. If it is a standard CAN message, the valid range is 0 to 2047. If extended, the range is 0 to  $2^{29}-1$ .

**Identifier type** — The value can be either 0 (standard identifier range) or 1 (extended identifier range) and defines the identifier type of the outgoing CAN message.

**Data frame size** — The value can be in the range of 0 to 8 and defines the data frame size in bytes of the outgoing CAN message

**Data** — Data for the data frame itself, defined as a double value (8 bytes). The CAN Packing block is used to construct the data as a double value.

Because all this information can be dynamically changed in FIFO mode during application execution, the information is provided at the block input instead of using the block parameters. To transmit more than one CAN message per block instance, use a matrix signal as a container for all information.

The dimension of the matrix signal entering the block must be  $n*5$ , where  $n$  is the number of CAN messages to be sent by this block instance. Therefore, each row of the matrix signal defines one CAN message and each row combines the five elements of information defined above (in this order).

For more information on how to construct the correct matrix signal for the FIFO write block, see “Examples” on page 5-40.

For certain applications it might be necessary to make the writing of a CAN message into the transmit FIFO dependent on the model dynamics. For this, the matrix signal can also be of dimension  $n*6$  instead of  $n*5$ . In this case, the sixth column defines whether the corresponding CAN message is written into the transmit FIFO (value 1) or not (value 0).

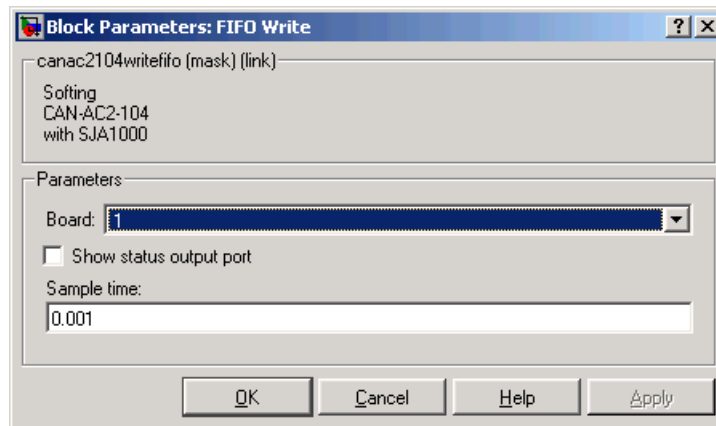

**Board** — Defines the board used to send the CAN messages defined by this block instance. For more information about the meaning of the board number, see the Setup driver block described above. If just one board is present in the target system, select board number 1.

**Show status output port** — Selecting this check box lets you enable the Status output port. If the box is cleared (disabled), the block does not have an output port. If enabled, a port is shown. The signal leaving the block is a vector of type double in which the number of elements depends on the signal dimension of the block input port. There is one element for each CAN message written into the transmit FIFO and the value is identical to the return argument of function `CANPC_send_data(...)`, described in the Softing user manual. Refer to that manual for more information.

**Sample time** — Defines the sample time at which the FIFO Write block is executed during a model (target application) run.

You can use as many instances of the FIFO Write block in the model as needed. For example, by using two instances of the block with different sample times, you can send CAN messages out at different rates. Or you can use multiple instances to structure your model more efficiently.

## FIFO Read Driver Block

The FIFO Read driver block reads CAN messages from the receive FIFO. The firmware running in FIFO mode puts received events (CAN messages) into the receive FIFO. From here, the FIFO Read driver reads the events out. The receive FIFO can store up to 255 events (messages). If it is full and no FIFO Read driver block attempts to read the stored events, new incoming events are lost. This is reflected by the incrementing of the lost message counter. You can use the FIFO Read RCV Level driver block to check for this condition and take appropriate action (for example, like stopping the execution or resetting the receive FIFO).

The FIFO Read driver block has at least one output port of type double. The signal of this port is a matrix of size  $m \times 6$ , where  $m$  is the FIFO read depth defined in the block's dialog box (see below). For example, if the FIFO read depth is 5, the matrix signal of port 1 has size  $5 \times 6$ . Therefore, there is one row for each event read from the receive FIFO (no new message is considered as an event as well). For information on how to extract data from the matrix signal, see “Examples” on page 5-40.

Each row with its six elements contains all the information defining a CAN message:

```
Port
Identifier
Event type
Data frame size
Timestamp
Data
```

**Port** — The value is either 1 (port 1) or 2 (port 2) and reports the port at which the CAN message was received.

**Identifier** — Identifier of the CAN message being received. If it is a standard CAN message, the range is 0 to 2047. If the CAN message is extended, the range is 0 to  $2^{29}-1$ .

**Event type** — Defines the type of event read from the receive FIFO. The following values are defined from the Softing user manual:

- 16 No new event
- 17 Standard data frame received
- 18 Standard remote frame received
- 19 Transmission of a standard data frame is confirmed
- 20 -
- 21 Change of bus state
- 22 -
- 23 -
- 24 Transmission of a standard remote frame is confirmed
- 25 Extended data frame received
- 26 Transmission of an extended data frame is confirmed
- 27 Transmission of an extended remote frame is confirmed
- 28 Extended remote frame received
- 29 -
- 30 -
- 31 Error frame detected

**Data frame size** — If a data frame has been received, the length of the data in bytes is reported by this element. Possible values are 0 to 8.

**Timestamp** — Reports the time at which the event was received. The resolution of the timestamp counter is 1  $\mu$ s.

**Data** — Data of the data frame itself. It is returned as a double value (8 bytes). The CAN Unpacking block is used to extract the data from the double value.



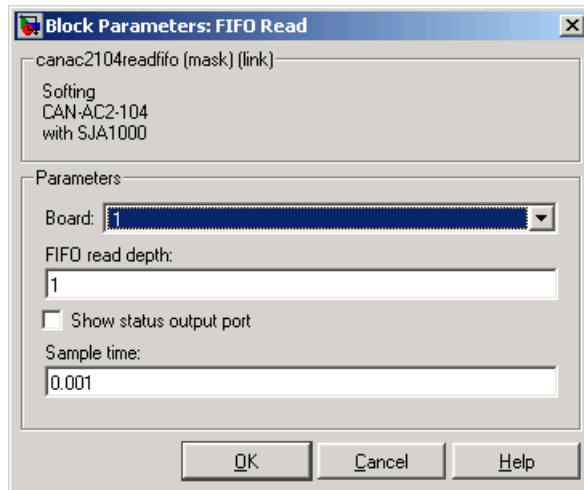

**Board** — Defines the board to use to send the CAN messages defined by this block instance. For more information about the meaning of the board number, see the Setup driver block described above. If just one board is present in the target system, select board number 1.

**FIFO read depth** — Defines the number of receive FIFO read attempts. Each time the block is executed, it reads this fixed number of events (CAN messages), which leads to a deterministic time behavior independent of the number of events currently stored in the receive FIFO. The read depth ( $m$ ) also defines the size of the matrix signal ( $m \times 6$ ) leaving the first output port. If no event is currently stored in the receive FIFO, the FIFO is read anyway but the event type is reported as 0 (no new event).

**Show status output port** — Lets you enable the status output port. If the box is cleared (disabled), the block has one output port for events. If enabled, a second port is shown. The signal leaving that port is a vector of type double with two elements:

[Number of lost messages (events), Bus state]

The first element returns the current value of the lost messages counter. The receive FIFO can store up to 255 events. If the receive FIFO is not regularly accessed for reading events, the FIFO is filled and the lost messages counter starts to increment. This is an indicator that events (messages) will be

unavoidably lost. The second element returns the current bus state. Possible values are

- 3 Error active
- 4 Error passive
- 5 Bus off

**Sample time** — Defines the sample time at which the FIFO Read block is executed during a model (target application) run.

Only use one instance of this block per physical CAN board in your model. Otherwise you may get unwanted behavior when one instance reads events while the events are being processed by blocks connected to the other, second instance.

### FIFO Read Filter Block

This is a utility block for the CAN FIFO driver block set, but does not actually access the CAN board or any other hardware device. This block is usually connected to the first output port of the FIFO Read driver block. It allows filtering events from the event matrix, which is the signal leaving the FIFO Read driver block.

The block code walks through the rows of the incoming event matrix signal and looks for matching events according to the criteria defined in the block's dialog box. If match is found, the entire event information (row) is written to the block's first output port. If more than one row matches the criteria, the later event overwrites the earlier event.

The block has one input port and two output ports. The input port is of type double and accepts a matrix signal of size  $m \times 6$ . The two output ports are of type double as well. The first output is a row vector ( $1 \times 6$ ), the filtered event. The second output is a scalar value that reports the number of matching events the filter block has processed.

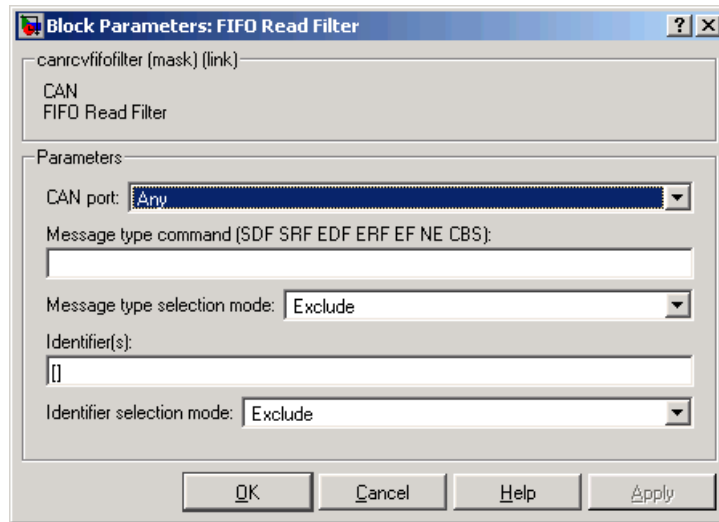

The dialog box of the FIFO Read Filter block lets you define the following settings:

**CAN port** — Defines the filter criterion for the CAN port. Possible choices are Any, 1, or 2.

**Message type command** — Defines the filter criterion for the event types. This entry can consist of a concatenation of space-delimited keywords:

- SDF Standard data frame
- SRF Standard remote frame
- EDF Extended data frame
- ERF Extended remote frame
- EF Error frame
- NE No new event
- CBS Change of bus state

**Message type selection mode** — Defines how the event type (message type) listed in **Message type command** is treated. If you select Include, the event type criterion is the sum of the concatenated keywords. If you select Exclude, the event type criterion is equal to all event types minus the sum of the concatenated keywords.

**Identifier(s)** — Defines the filter criterion for the CAN message identifiers. A set of identifiers can be provided as a row vector.

**Identifier selection mode** — Defines how the identifier criterion entered in the **Identifier(s)** parameter is treated. If you select **Include**, the identifier criterion is the sum of all specified identifiers. If you select **Exclude**, the identifier criterion is equal to all identifiers minus the specified identifiers.

You can use as many instances of this block in your model as needed. Usually, you connect several instances in parallel to the output of the FIFO Read driver block to filter out particular messages or events. For more information on how to do this, see “Examples” on page 5-40.

## FIFO Read XMT Level Driver Block

The FIFO Read XMT Level driver block is used to read the current number of CAN messages stored in the transmit FIFO to be processed by the firmware. The transmit FIFO can store up to 255 messages. If it is full and a FIFO write driver block tries to add another message to the transmit FIFO, the passed messages are lost. You can use this driver block to check for this condition and take appropriate action. For example, you can stop the execution or wait for the transmit FIFO to empty.

The block has a single output port of type double returning a scalar value containing the current transmit FIFO level (number of messages to be processed).

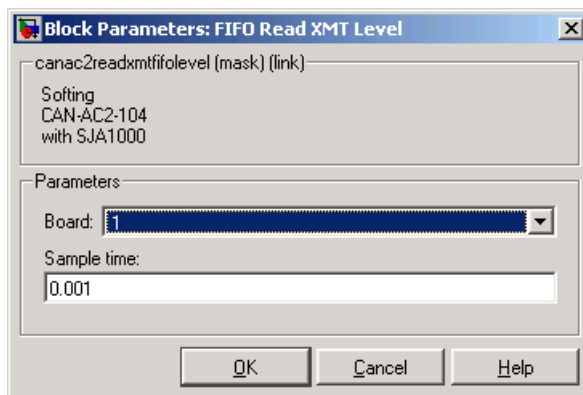

**Board** — Defines the board to access to read the current transmit FIFO level. For more information about the meaning of the board number, see the Setup driver block described above. If just one board is present in the target system, select board number 1.

**Sample time** — Defines the sample time at which the FIFO Read XMT Level driver block is executed during a model (target application) run.

## FIFO Reset XMT Driver Block

The FIFO Reset XMT driver block resets the transmit FIFO. This deletes all messages currently stored in the transmit FIFO and resets the level counter to 0. For example, you can use this driver block to reset the transmit FIFO after detecting a fault condition.

The block has a single input port of type double. If a scalar value of 1 is passed, the transmit FIFO is reset; if 0 is passed, no action takes place.

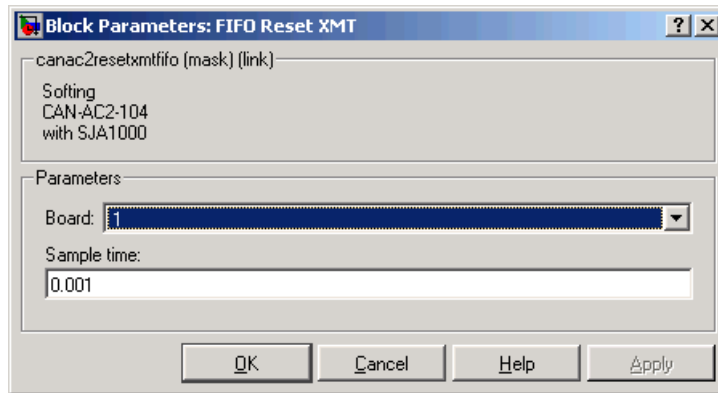

**Board** — Defines the board to access to reset the transmit FIFO. For more information about the meaning of the board number, see the Setup driver block described above. If just one board is present in the target system, select board number 1.

**Sample time** — Defines the sample time at which the FIFO Reset XMT driver block is executed during a model (target application) run.

## FIFO Read RCV Level Driver Block

The FIFO Read RCV Level driver block reads the current number of CAN messages stored in the receive FIFO. The receive FIFO can store up to 255 events (messages). If it is full and no FIFO Read driver block attempts to read the stored events, new incoming events are lost. This is reflected by the incrementing of the lost message counter. You can use this driver block to check for this condition and take appropriate action (for example, like stopping the execution or resetting the receive FIFO).

The block has a single output port of type double returning a scalar value containing the current receive FIFO level (number of messages to be processed).

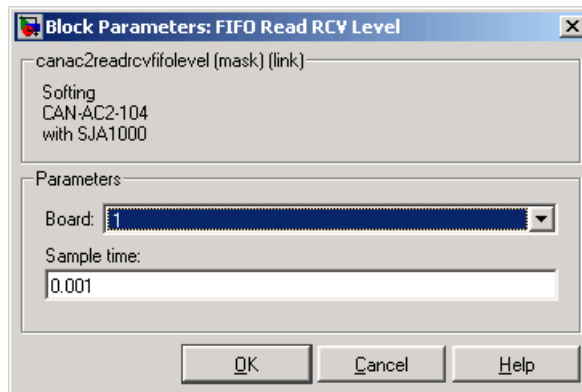

**Board** — Defines the board to access to read the current receive FIFO level. For more information about the meaning of the board number, see the Setup driver block described above. If just one board is present in the target system, select board number 1.

**Sample time** — Defines the sample time at which the FIFO Read RCV Level driver block is executed during a model (target application) run.

## FIFO Reset RCV Driver Block

The FIFO Reset RCV driver block resets the receive FIFO. This deletes all messages currently stored in the receive FIFO and resets the level counter to 0. For example, you can use this driver block to reset the receive FIFO after detecting a fault condition.

The block has a single input port of type double. If a scalar value of 1 is passed, the transmit FIFO is reset; if 0 is passed no action takes place.

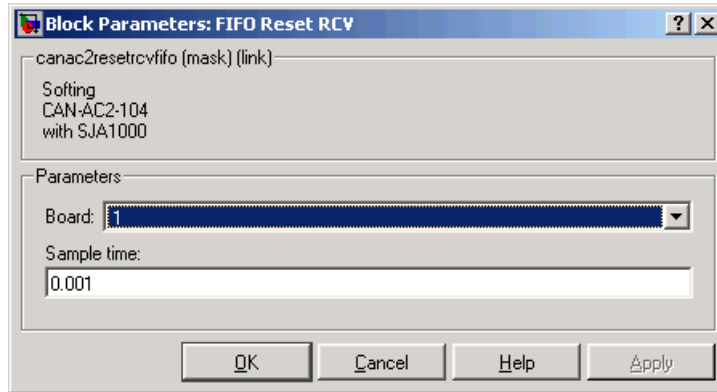

**Board** — Defines the board to access to reset the receive FIFO. For more information about the meaning of the board number, see the Setup driver block described above. If just one board is present in the target system, select board number 1.

**Sample time** — Defines the sample time at which the FIFO Reset RCV driver block is executed during a model (target application) run.

## Acceptance Filters

As mentioned earlier, you can use the CAN controller's acceptance filters to ensure that certain received messages referenced by their identifiers are written into the receive FIFO. Therefore, fewer read attempts are necessary to get at the messages that are of importance for the target application.

The behavior of the acceptance filter is described for standard and extended identifier ranges individually (one for standard identifiers and one for extended identifiers). Each acceptance filter is defined by a mask parameter and a code parameter.

The mask parameter defines, for each bit of the identifier, whether the filtering process cares about this bit or not. A 0 means "don't care" and a 1 means "do care."

The code parameter then defines, for each bit of the identifier, that the filtering process cares about (defined by the mask parameter), what the bit value has to be (0 or 1).

For standard identifiers the mask parameter and code parameter must be both, in the range 0 to 2047. For extended identifiers the mask parameter and code parameter must be both, in the range 0 to  $2^{29}-1$ .

The filtering process evaluates the following binary expression:

$$\text{and}(\text{xor}(\text{mask}, \text{identifier}), \text{code})$$

If all bits of the resulting value are 0, the message with this identifier is accepted. If any bit is 1, the message is voided.

According to this description, acceptance filters work using binary evaluation, while most applications differentiate messages (identifiers) in a decimal or hexadecimal manner. As a consequence, it is possible to filter messages, whose identifiers are above a certain decimal number. The opposite (identifiers below a certain decimal number) cannot be achieved in a general way.



## Examples

The default values for the mask parameter and the code parameter in the FIFO setup driver block are both 0. These parameter values ensure (the above expression always evaluates to 0) that all incoming messages will reach the receive FIFO (no filtering takes place). All parameter values are defined using decimal numbers. You can use the MATLAB function `hex2dec` to define hexadecimal numbers in the dialog box entry.

Assume a CAN application where messages with the following identifiers (standard) are crossing the CAN network:

2-30, 48-122 (decimal)

Additionally, only incoming messages 4-29 must be processed by the target application. Ideally, all messages not having identifiers 4-29 would be filtered out, but the mask and code parameters do not allow this exact scheme. The closest you can achieve is filtering out all messages with identifiers above 31 by using value  $2047-31=2016$  for the mask parameter and value 0 for the code parameter. The messages with identifier 0, 1, 2, and 3 cannot be filtered out and are returned by the FIFO read driver block, even if they do not need to be processed by the target application.

# Examples

This section includes the following topics:

- “Example 1” on page 5-40 — Loop-back test from CAN port 1 to CAN port 2
- “Example 2” on page 5-42 — Filtering out events
- “Example 3” on page 5-43 — Constructing CAN messages dynamically at run-time
- “Example 4” on page 5-44 — Stopping the execution when a FIFO overflow occurs
- “Example 5” on page 5-44 — Stopping the execution when a FIFO overflow occurs
- “Example 6” on page 5-45 — Using CAN acceptance filters

## Example 1

Start with a simple model using the FIFO Setup block, FIFO Write block, FIFO Read block, and FIFO Read Filter block. The entire CAN network consists of a single physical connection between CAN port 1 and port 2 (loop-back configuration). Both CAN ports must be terminated properly.

The objective of the application is the following:

- Send a message with extended identifier 5100 and change data every millisecond on port 1.
- Send a message with standard identifier 112 and change data every even millisecond on port 1.
- Send a message with standard identifier 114 and change data every odd millisecond on port 1.
- Read three events every millisecond from the receive FIFO on port 2.
- Display the incoming data of the three messages separately.
- Do not use acceptance filtering (all messages are accepted).

The data transmitted with the CAN messages are double values in all the following examples. This has been chosen for simplicity. You should refer to the bit-packing and bit-unpacking chapter of the standard CAN driver documentation on how to construct the data.

The first implementation uses the following scheme.

The matrix signal entering the FIFO Write block consists of all three messages including the Control element (sixth element); therefore the matrix size is [3,6]. The sample time of the FIFO Write block is defined as 1 millisecond. For the standard identifiers that must be sent out every other millisecond, the Control element is alternated accordingly. You do this by using a Unit delay block with corresponding feedback as the Control element value.

The FIFO Read block has a read depth of 3 and also a base sample of 1 millisecond. Three FIFO filter blocks are connected to the output of the FIFO read block (in parallel) to extract the information of the incoming CAN messages. You can display the model by typing, in the MATLAB Command Window, either `xpccanpcififo1` or `xpccan104fiffo1`.

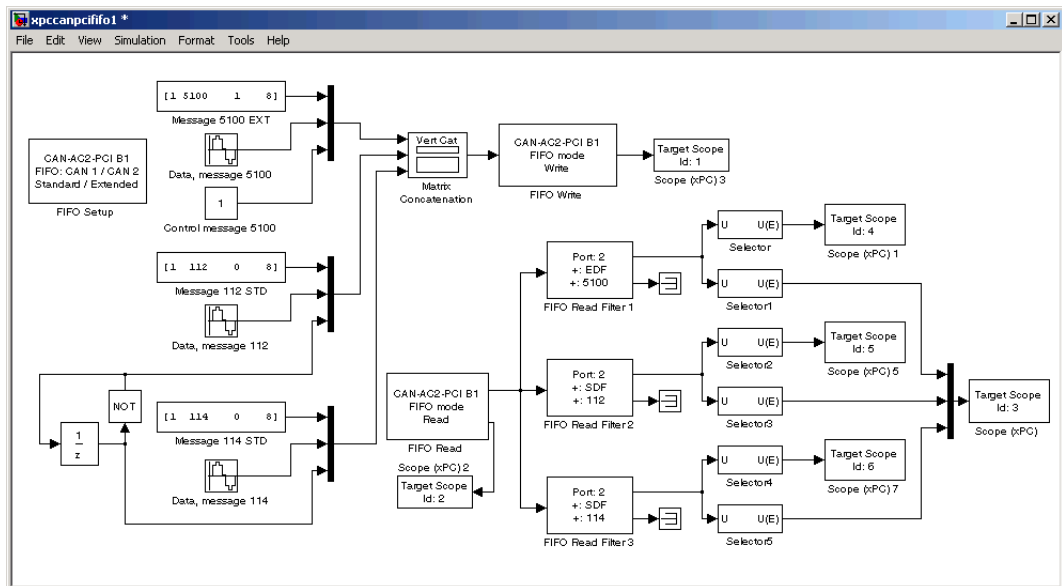

The model uses several xPC Target scope blocks to display different types of data on the target screen:

- Scope 1 (numerical) displays the status vector leaving the FIFO Write block.
- Scope 2 (numerical) displays the status vector [lost-message-counter, bus state] leaving the FIFO Read block.
- Scope 3 (graphical) plots the data of all three CAN messages being received.

- Scopes 4-6 (numerical) displays the other relevant message data of the three incoming CAN messages individually (port, identifier, type, data length, timestamp).

## Example 2

When looking at the time behavior of the model, you can observe that at each millisecond two CAN messages are sent out via the FIFO Write block, while the FIFO Read block reads three events each millisecond from the receive FIFO. This implies that one of the three events leaving the FIFO Read block is of type No new event. You can show this by attaching another FIFO Filter block in parallel that filters “No new events”, and then displaying the second output port, which reports the number of matching events. You can display the model by typing, in the MATLAB Command Window, either `xpccanpcififo2` or `xpccan104fifo2`.

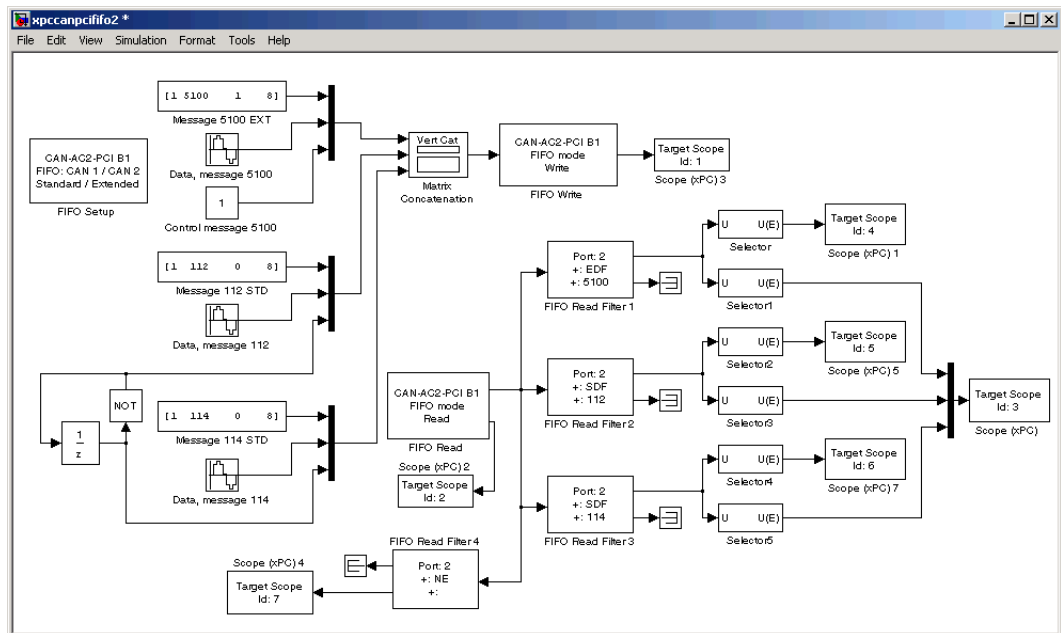

Having observed this, you can reduce the read depth of the FIFO Read block from 3 to 2. This would not change the overall behavior of the model. As a

positive side effect, the latency time of the FIFO Read block becomes smaller and therefore the model's cycle time as well.

### Example 3

Now look at a second implementation on the FIFO Write side. Instead of providing three messages in parallel, you can just write two messages and then alternate the identifier and data of the second CAN message to be sent. Because the messages are now sent every millisecond in any case, you need not provide the Control element, thereby reducing the matrix entering the FIFO Write block to a size of [2,5]. You can display the model by typing, in the MATLAB Command Window, either `xpccanpcfifo3` or `xpccan104fiffo3`.

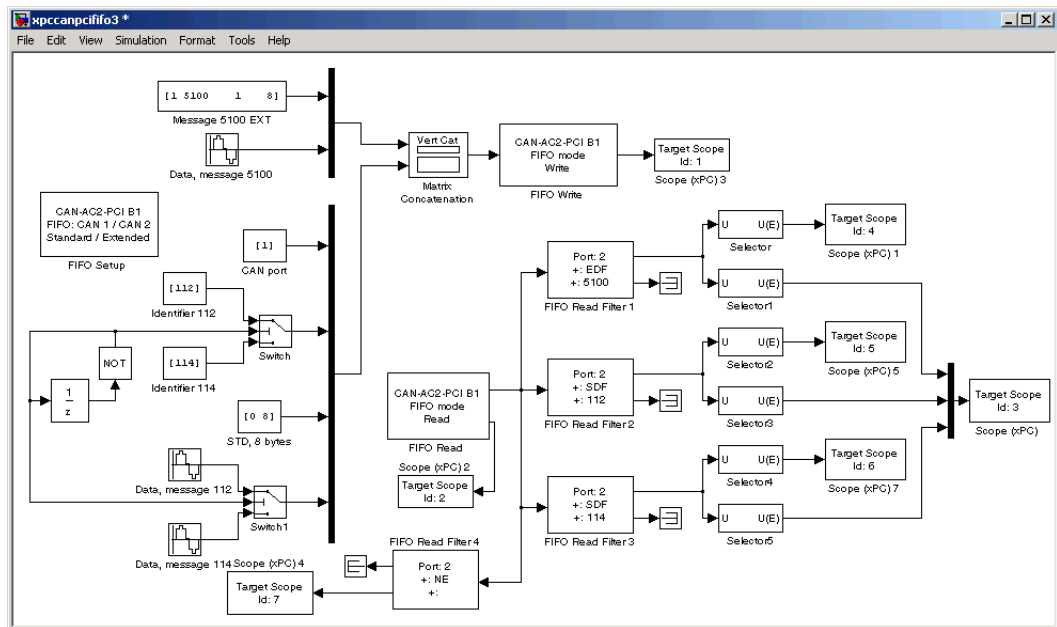

This implementation behaves exactly like the first implementation, but shows how CAN messages to be sent can be constructed dynamically at run-time.

## Example 4

Look at the situation where the read depth parameter of the FIFO Read block in the model above is set to 1 instead of 2 or 3. This leads to a receive FIFO overflow when the execution time reaches 256 milliseconds. Here, for example, the execution should be stopped if the overflow occurs. This can be done easily by evaluating the lost message counter value leaving the status output port of the FIFO Read block. You can display the model by typing, in the MATLAB Command Window, either `xpccanpcfifo4` or `xpccan104fif04`.

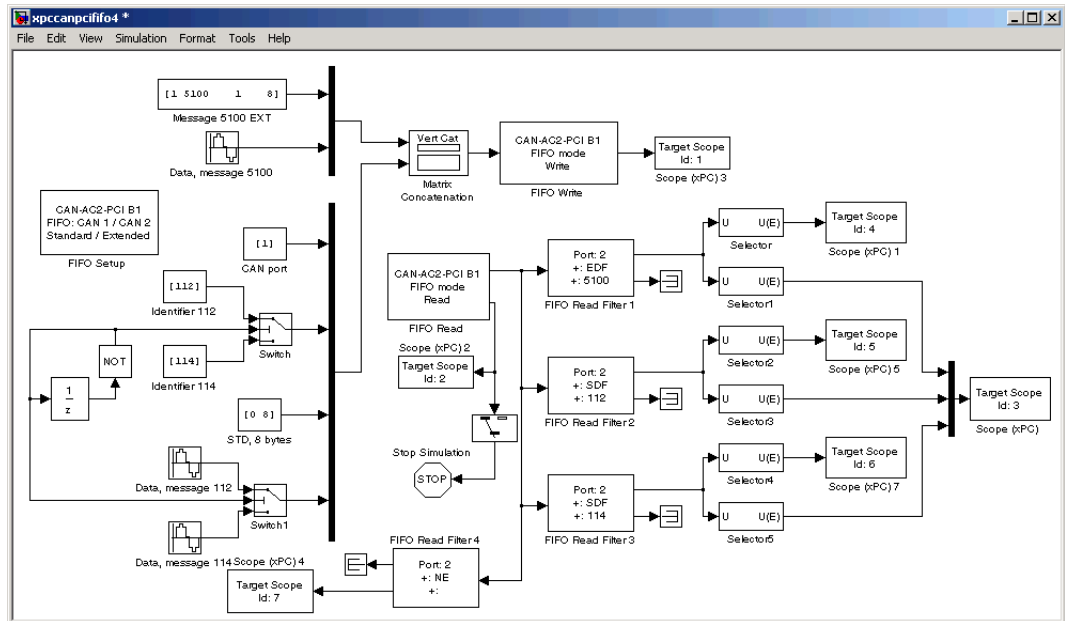

## Example 5

Consider a different handling of the receive FIFO overflow: If the receive FIFO level reaches the value of 200, the receive FIFO should be reset to delete all currently stored events. The application execution has to continue normally. For this, you need to add two new driver blocks to the model, which are used to read the receive FIFO level and then reset it. You can display the model by typing, in the MATLAB Command Window, either `xpccanpcfifo5` or `xpccan104fif05`.

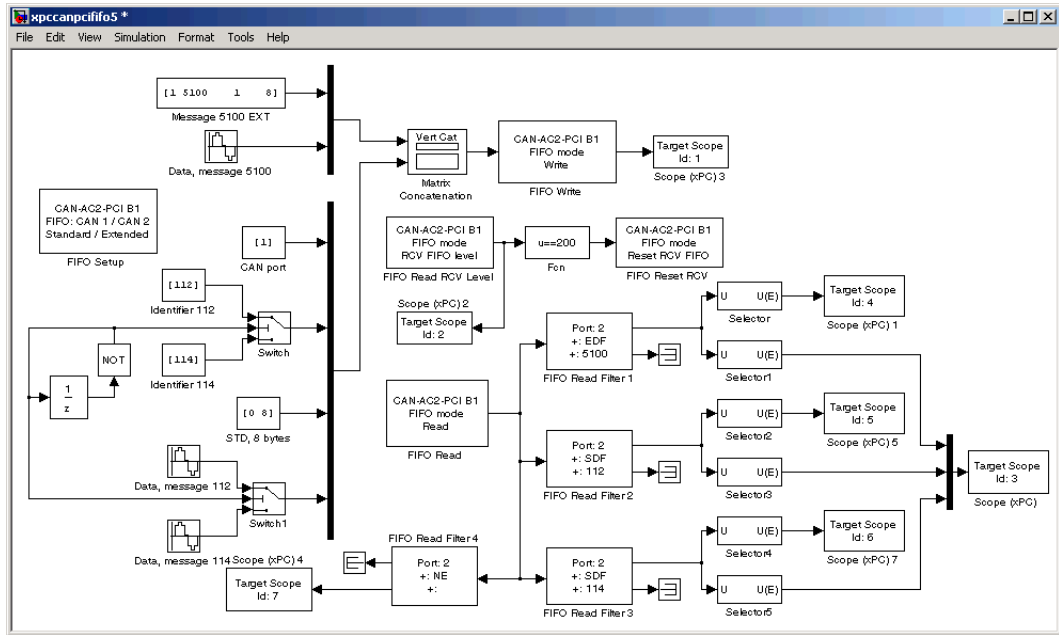

## Example 6

The next example shows the use of the CAN acceptance filters. First the Read depth parameter of the FIFO Read block is set to a value of 2. Then the identifier of the second standard message is changed from 114 to 188. The goal is to filter any CAN messages with an identifier larger than 127. This means that the receive FIFO never contain the CAN message with identifier 188. Also, the FIFO Filter block, filtering CAN message with identifier 114, is changed to filter the message with identifier 188. To achieve this, the **Acceptance Filters** parameter of CAN port 2 in the FIFO Setup block must be set accordingly:

```
[2047-127, 0, 0, 0]
```

If you rebuild and reexecute the target application, you can see the following:

- Scope with ID 6 shows 0 for all elements of the vector leaving the corresponding FIFO Filter block. The message with identifier 188 is never received.

- Scope with ID 3 shows one of the data traces always being zero.
- Scope with ID 7 shows a value of 1, which reflects that the read depth could be reduced to 1, because only one message per millisecond reaches the receive FIFO now.

You can display the model by typing, in the MATLAB Command Window, either `xpccanpcififo6` or `xpccan104fifo6`.

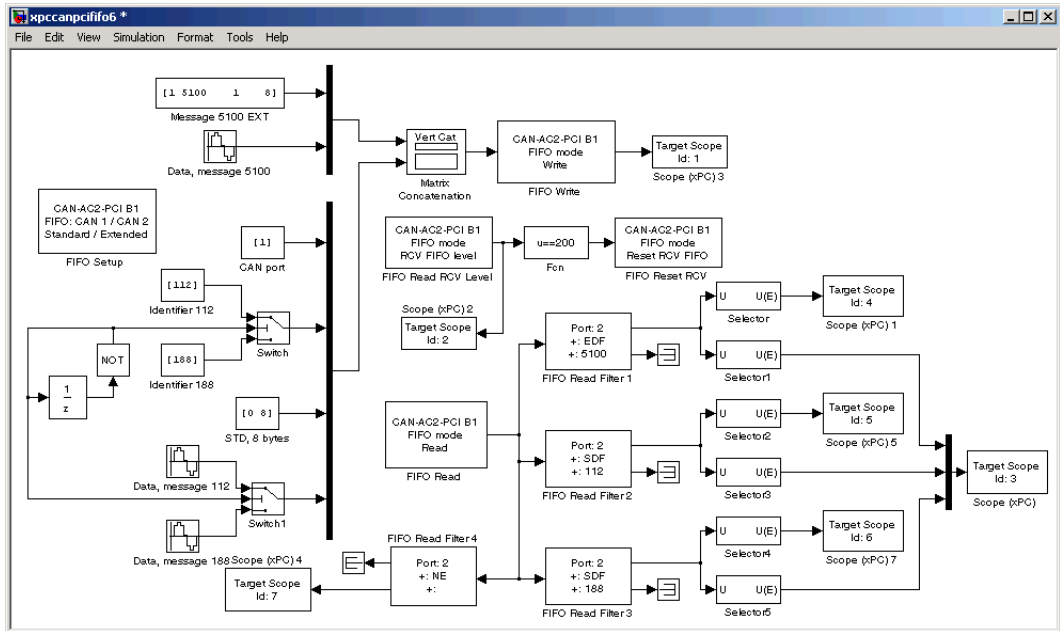



# UDP I/O Support

---

xPC Target provides support for the UDP/IP communication protocol. This chapter includes the following sections:

- |                                       |                                                                                                                                               |
|---------------------------------------|-----------------------------------------------------------------------------------------------------------------------------------------------|
| User Datagram Protocol (UDP) (p. 6-2) | Send and receive messages from a target application using UDP packets.                                                                        |
| xPC Target UDP Blocks (p. 6-5)        | Description of the block parameter fields for the xPC Target blocks that support UDP communication.                                           |
| xPC Target UDP Examples (p. 6-13)     | Communicate between two xPC Target applications, between a target application and Simulink models or systems, or between two Simulink models. |

## User Datagram Protocol (UDP)

xPC Target supports communication from the target PC to other systems or devices using User Datagram Protocol (UDP) packets. UDP is a transport protocol similar to TCP. However, unlike TCP, UDP provides a direct method to send and receive packets over an IP network. UDP uses this direct method at the expense of reliability by limiting error checking and recovery. This section includes the following topics:

- “What Is UDP?” on page 6-2
- “Why UDP?” on page 6-4

### What Is UDP?

The User Datagram Protocol (UDP) is a transport protocol layered on top of the Internet Protocol (IP) and is commonly known as UDP/IP. It is analogous to TCP/IP. A convenient way to present the details of UDP/IP is by comparison to TCP/IP as presented below:

- **Connection Versus Connectionless** — TCP is a *connection based* protocol, while UDP is a *connectionless* protocol. In TCP, the two ends of the communication link must be connected at all times during the communication. An application using UDP prepares a packet and sends it to the receiver’s address without first checking to see if the receiver is ready to receive a packet. If the receiving end is not ready to receive a packet, the packet is lost
- **Stream Versus Packet** — TCP is a *stream-oriented* protocol, while UDP is a *packet-oriented* protocol. This means that TCP is considered to be a long stream of data that is transmitted from one end to the other with another long stream of data flowing in the other direction. The TCP/IP stack is responsible for breaking the stream of data into packets and sending those packets while the stack at the other end is responsible for reassembling the packets into a data stream using information in the packet headers. UDP, on the other hand, is a packet-oriented protocol where the application itself divides the data into packets and sends them to the other end. The other end does not have to reassemble the data into a stream. Note, some applications might indeed present the data as a stream when the underlying protocol is UDP. However, this is the layering of an additional

protocol on top of UDP, and it is not something inherent in the UDP protocol itself.

- **TCP Is a Reliable Protocol, While UDP Is Unreliable** — The packets that are sent by TCP contain a unique sequence number. The starting sequence number is communicated to the other side at the beginning of communication. Also, the receiver acknowledges each packet, and the acknowledgment contains the sequence number so that the sender knows which packet was acknowledged. This implies that any packets lost on the way can be retransmitted (the sender would know that they did not reach their destination because it had not received an acknowledgment). Also, packets that arrive out of sequence can be reassembled in the proper order by the receiver.

Further, time-outs can be established, because the sender will know (from the first few packets) how long it takes on average for a packet to be sent and its acknowledgment received. UDP, on the other hand, simply sends the packets and does not keep track of them. Thus, if packets arrive out of sequence, or are lost in transmission, the receiving end (or the sending end) has no way of knowing.

TCP communication can be compared to a telephone conversation where a connection is required at all times and two-way streaming data (the words spoken by each party to the conversation) are exchanged. UDP, on the other hand, can be compared to sending letters by mail (without a return address). If the other party is not found, or the letter is lost in transit, it is simply discarded. The analogy fails, however, when considering the speed of communication. Both TCP and UDP communication roughly happen at the same speed, because both use the underlying Internet Protocol (IP) layer.

---

**Note** *Unreliable* is used in the sense of “not guaranteed to succeed” as opposed to “fails a lot of the time.” In practice, UDP is quite reliable as long as the receiving socket is active and is processing data as quickly as it arrives.

---

## **Why UDP?**

UDP was chosen as the transport layer for xPC Target precisely because of its lightweight nature. Since the primary objective of an application running in the xPC Target framework is real-time, the lightweight nature of UDP ensures that the real-time application will have a maximum chance of succeeding in real-time execution. Also, the datagram nature of UDP is ideal for sending samples of data from the Real-Time Workshop-generated application. Because TCP is stream oriented, separators between sets of data must be used for the data to be processed in samples. It is easier to build an application to deal with unreliable data than it is to decode all of this information in realtime. If the application is unable to process the data as quickly as it arrives, the following packets can just be ignored and only the most recent packet can be used.

Communication can involve a packet made up of any Simulink data type (double, int8, int32, uint8, etc.), or a combination of these. xPC Target provides blocks for combining various signals into one packet (packing), and then transmitting it. xPC Target also provides blocks for splitting a packet (unpacking) into its component signals that can then be used in a Simulink model. The maximum size of a packet is limited to about 500 bytes.

## **Note on UDP Communication**

The UDP blocks work in the background when the real-time application is not running. The UDP communication has been set up to have a maximum of two UDP packets waiting to be read. All subsequent packets are rejected. This prevents excessive memory usage and minimizes the load on the TCP/IP stack. Consequently, when any large background task is performed, such as uploading a screen shot or communicating large pages through the WWW interface, packet loss might occur. Design applications so that this is not critical. In other words, the receipt of further packets after the ones that were lost ensures seamless continuation.

## xPC Target UDP Blocks

This section includes the following topics:

- “UDP Communication Setup” on page 6-5
- “UDP Receive Block” on page 6-6
- “UDP Send Block” on page 6-8
- “UDP Pack Block” on page 6-9
- “UDP Unpack Block” on page 6-10
- “Byte Reversal/Change Endianness Block” on page 6-11

### UDP Communication Setup

The infrastructure provided in the xPC Target Library for UDP communication consists mainly of two blocks — a Send block and a Receive block. These blocks are in the xPC Target Library, available from the Simulink Library under **xPC Target**. You can also access them from the MATLAB command line by typing

```
xpplib
```

The blocks are located under the UDP heading in the library. The Send block takes as input a vector of type `uint8`, which it sends. This is limited to a length of about 500 bytes (i.e., a 1 by 500 vector). Similarly, the Receive block outputs a vector of `uint8`. To convert arbitrary Simulink data types into this vector of `uint8`, a Pack block is provided, while an Unpack block is provided to convert a vector of `uint8s` back into arbitrary Simulink data types.

You can have up to 32 UDP blocks in any given model (Send and Receive blocks combined in any order).

xPC Target includes a Byte Reversal block for communication with *big-endian* architecture systems. You do not need this block if you are communicating between 80x86-based PC systems running either xPC Target or Microsoft Windows.

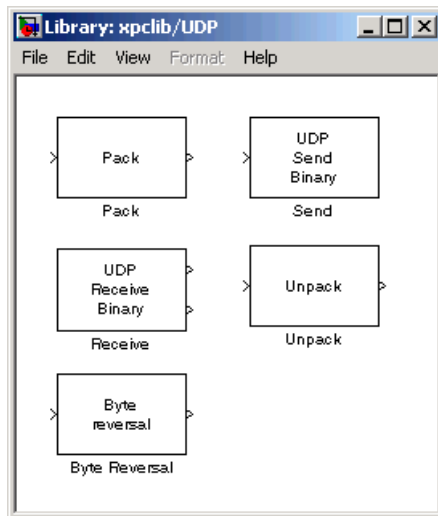

All the blocks are set up to work both from within Simulink and from an application running under xPC Target. However, you must be careful when using a Simulink simulation and an xPC Target application to communicate, or when using two Simulink models. This is because a Simulink model executes in nonreal time and can be several times faster or slower than real time. The sample time of the send and receive blocks and the sample time of the Simulink model must be set so that the communication can proceed properly.

## UDP Receive Block

The Receive block has two output ports. The first port is the output of the received data as a vector of uint8 while the second one is a flag indicating whether any new data has been received. This port outputs a value of 1 for the sample when there is new data and a 0 otherwise. The default behavior of the Receive block is to keep the previous output when there is no new data. You can modify this behavior by using the second port to flag when there is new data.

The block parameters for the Review block are shown below.

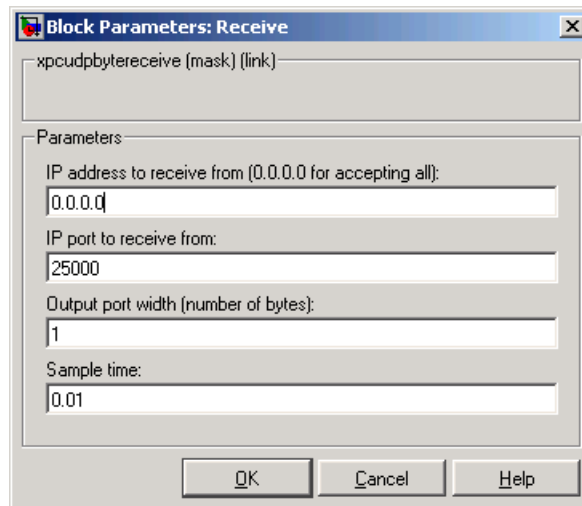

The **IP address to receive from** parameter can be left with the default value of 0.0.0.0. This accepts all UDP packets from any other computer. If set to a specific IP address, only packets arriving from that IP address are received. The **IP port to receive from** parameter is the port that the block accepts data from. The other end of the communication sends data to the port specified here. The output port width is the width of the acceptable packets. You can obtain this when designing the other side (send side) of the communication. The sample time can be set to -1 for inheritable sample time, but it is recommended that this be set to some specific (large) value to eliminate chances of dropped packets. This is especially true when you are using a small base sample time.

## UDP Send Block

The Send block has only one input port, which receives the uint8 vector that is sent as a UDP packet.

The block parameters for the Send block are shown below.

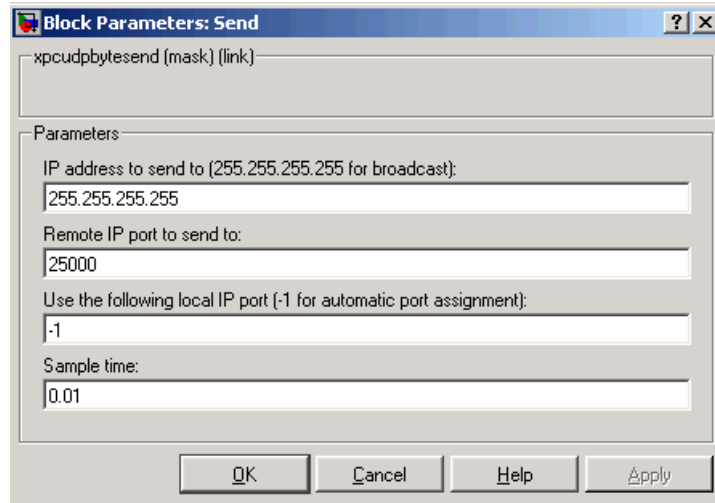

Specify the **IP address to send to** and **IP port to send to** parameters in the appropriate locations.

Set the **Use the following local IP port** parameter to -1 (default) to allow the networking stack to automatically determine the local IP port that is used for sending. Otherwise, specify a particular port to send a packet from that port.

Set the **Sample time** parameter to an appropriate value, with the same considerations as in the Receive block.



## UDP Pack Block

The Pack block is used to convert one or more Simulink signals of varying data types to a single vector of `uint8` as required by the Send block. The data types for the different signals must be specified as part of the block parameters, while the sizes of the signals are determined automatically.

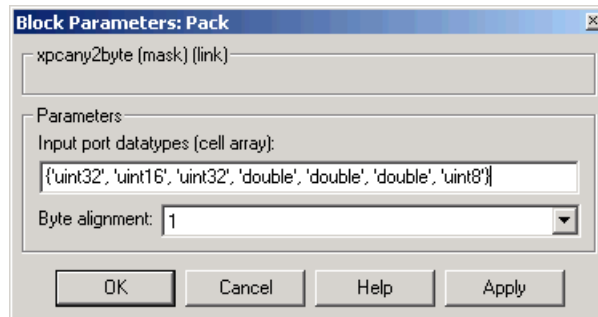

As seen in the figure above, the data types of each of the signals must be specified as a cell array of strings in the correct order. Once this is done, the block automatically converts itself to one with the correct number of input ports. There is always one output port. The supported data types are `double`, `single`, `int8`, `uint8`, `int16`, `uint16`, `int32`, `uint32`, and `boolean`. The byte alignment field specifies how the data types are aligned. The possible values are: 1, 2, 4, and 8. The byte alignment scheme is simple, and ensures that each element in the list of signals starts on a boundary specified by the alignment relative to the start of the vector. For example, say the Input port data types are specified as

```
{'uint8', 'uint32', 'single', 'int16', 'double'}
```

and an alignment of 4 is used. Assume also that all the signals are scalars. The first signal then starts at byte 0 (this is always true), the second at byte 4, the third at byte 8, the fourth at byte 12, and the fifth at byte 16. Note that the sizes of the data types used in this example are 1, 4, 4, 2, and 8 bytes respectively. This implies that there are “holes” of 3 bytes between the first and second signal and 2 bytes between the fourth and fifth signal.

A byte alignment of 1 means the tightest possible packing. That is, there are no holes for any combination of signals and data types.

---

**Note** Individual elements of vector/matrix signals are not byte aligned: only the entire vector/matrix is byte aligned. The individual elements are tightly packed with respect to the first element.

---

## UDP Unpack Block

This block is the exact analog of the Pack block. It receives a vector of uint8 and outputs various Simulink data types in different sizes.

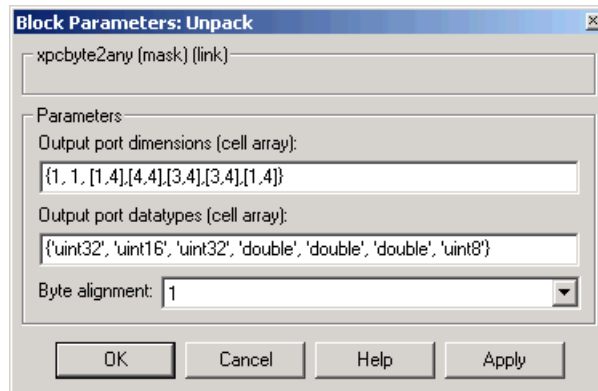

As shown in the figure above, the **Output port datatypes** field is the same as the **Input port data types** field of the matching Pack block. The Pack block is on the sending side and the Unpack block is on the receiving side in different models. The **Output port dimensions** field contains a cell array, with each element the dimension returned by the size function in MATLAB of the corresponding signal. This should normally be the same as the dimensions of the signals feeding into the corresponding Pack block.

## Note on Byte Alignment

The byte-alignment feature provided in the Pack and Unpack blocks is primarily intended for interfacing a system running xPC Target to another system that is running neither Simulink nor xPC Target. For example, the data on the other end might be in the form of a C struct, which is subject to the byte-alignment convention of the compiler used. We recommend using a byte-alignment value of 1 (tightly packed) whenever possible. Of course, this is easily accomplished when UDP I/O is used to exchange data between two xPC Target systems or between xPC Target and Simulink.

Even when communication is between xPC Target and a system using a C struct, the use of compiler pragmas might help to pack the structure tightly. For example, `#pragma pack(1)` is common to several compilers. The byte-alignment blocks are provided for the case when this is not possible.

## Byte Reversal/Change Endianness Block

You use the Byte Reversal/Change Endianness block for communication between an xPC Target system and a system running with a processor that is *big-endian*. Processors compatible with the Intel 80x86 family are always *little-endian*. For this situation, you should insert a Byte Reversal/Change Endianness block before the Pack block and just after the Unpack block to ensure that the values are transmitted properly. The following is the Change Endianness block.

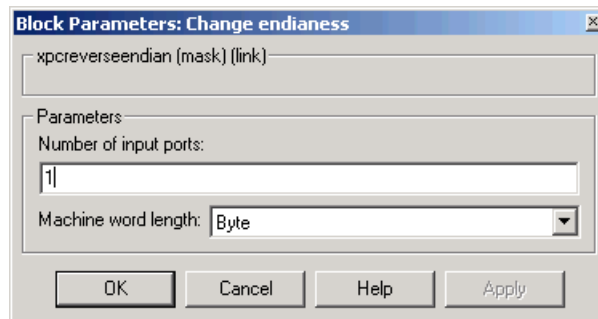

This block has the following parameters:

**Number of input ports** — The number of input ports adjusts automatically to follow this parameter, and the number of outputs is equal to the number of inputs.

**Machine word length** — Select one of the following machine word lengths to which to convert the data:

- Byte
- Word
- Double Word

The following is the Byte Reversal block.

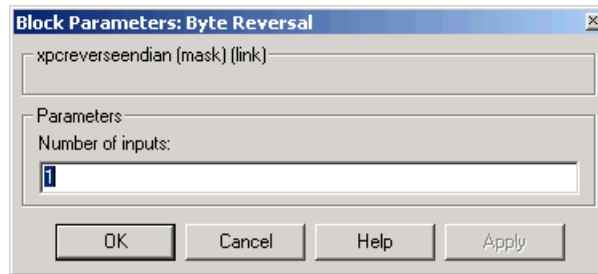

This block has the following parameter:

**Number of inputs** — The number of input ports adjusts automatically to follow this parameter, and the number of outputs is equal to the number of inputs.

---

## xPC Target UDP Examples

This section includes the following topic:

- “UDP Example” on page 6-13

### UDP Example

This section provides an example of how to set up two-way data exchange between two xPC Target systems, between xPC Target and Simulink, or between two Simulink models. When one or both of the systems is running Simulink in nonrealtime, be sure to set the sample time properly.

---

**Note** To use UDP for your xPC Target system, be sure to create a TCP/IP boot disk and boot the target PC with that boot disk.

---

The hypothetical models are called `udpsendreceiveA` and `udpsendreceiveB`. Two different sets of data are transferred between these two models, one set from `udpsendreceiveA` to `udpsendreceiveB` and another set in the opposite direction.

The data to transfer is in the following order:

`udpsendreceiveA` to `udpsendreceiveB`

- `uint8 (3x3)`
- `uint16 (1x1)`
- `double (2x4)`

`udpsendreceiveB` to `udpsendreceiveA`

- `single (4x1)`
- `double (2x2)`
- `uint32 (2x2)`
- `int8 (5x3)`

For the purposes of this example, all the inputs are generated using Simulink Constant blocks that use the MATLAB random number function (`rand`). The random numbers are generated by Real-Time Workshop using this function

at the time of code generation. To generate the vector of uint8 (3x3), use the MATLAB function

```
uint8(255 * rand(3,3))
```

since 255 is the maximum value for an unsigned 8-bit integer. The other values are generated similarly.

With this setup, construct the send side of udpsendreceiveA.

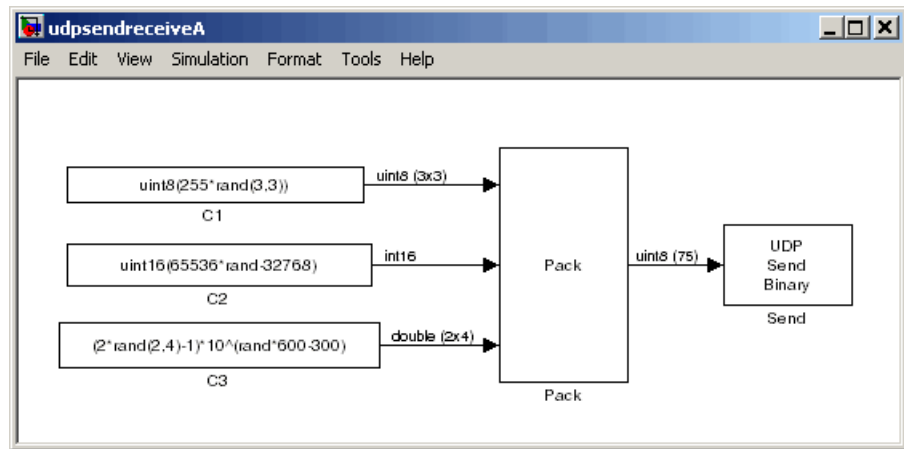

Note that the width of the UDP packet to be sent is 75 bytes. The parameters used in the Pack block are **Input port datatypes** `{'uint8', 'uint16', 'double'}` and **Byte Alignment** 1.

For the Send block, set the **IP Address to send to** to 192.168.0.2. This is the hypothetical address of the system that will run udpsendreceiveA. Set the **IP Port to send to** to 25000 (picked arbitrarily). The sample time is set to 0.01.

Use this information to construct the receive end of udpsendreceiveB.

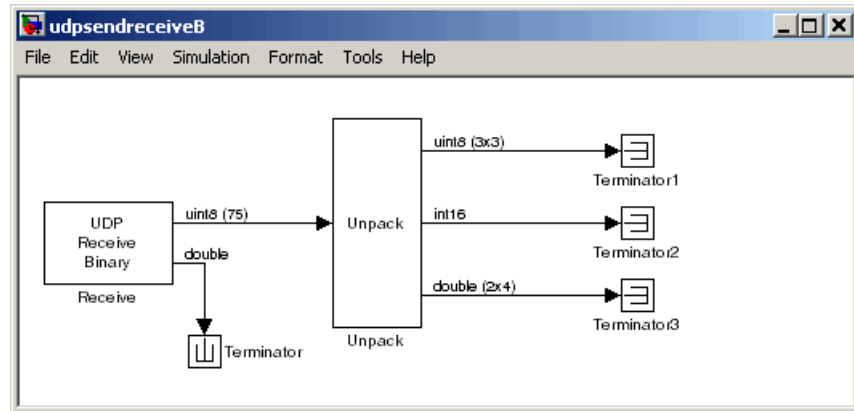

For setting up the Receive block, set **IP address to receive from** to 192.168.0.2 (the hypothetical address of the system that will run udpsendreceiveB). The **IP port to receive from** is set to 25000 (the same value as set in the Send block in udpsendreceiveA). The **Output port width** is set to 75, which is obtained from the output port width of the Pack block in udpsendreceiveA.

For the Unpack block, **Byte Alignment** is set to 1 and the **Output port datatypes** is set to {'uint8', 'int16', 'double'} from the Pack block in udpsendreceiveA. The **Output port dimensions** is set to {[3 3], 1, [2 4]} from the dimensions of the inputs to the Pack block in udpsendreceiveA.

Note that in udpsendreceiveB, the second output port of the Receive block is sent into a terminator. You can use this to determine when a packet has arrived. The same is true for the outputs of the Unpack block, which in a real model would be used in the model.

For constructing the udpsendreceiveB to udpsendreceiveA side of the communication, follow an analogous procedure. The final udpsendreceiveA is shown below.

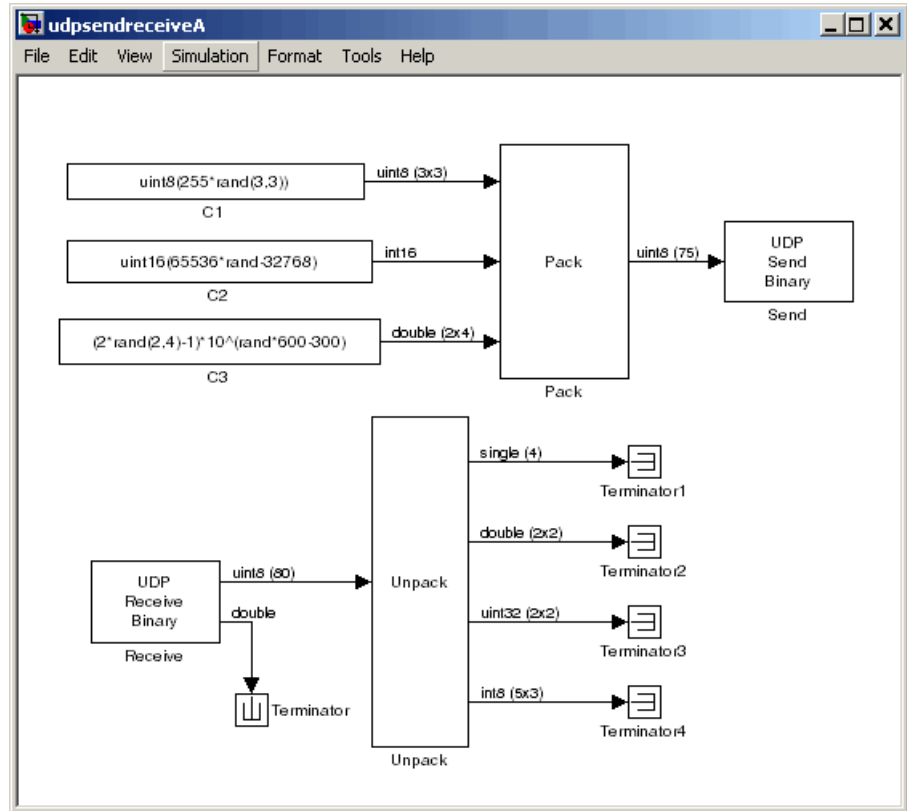



The following table lists the parameters in `udpreceiveA`.

| <b>Block</b> | <b>Parameter</b>       | <b>Value</b>                            |
|--------------|------------------------|-----------------------------------------|
| Receive      | IP address             | 192.168.0.1                             |
|              | IP port                | 25000                                   |
|              | Output port width      | 80                                      |
|              | Sample time            | 0.01                                    |
| Unpack       | Output port dimensions | {4,[2 2],[2 2],[5 3]}                   |
|              | Output port data types | {'single','double',<br>'uint32','int8'} |
|              | Byte alignment         | 2                                       |

The final `udpreceiveB` model is shown below.

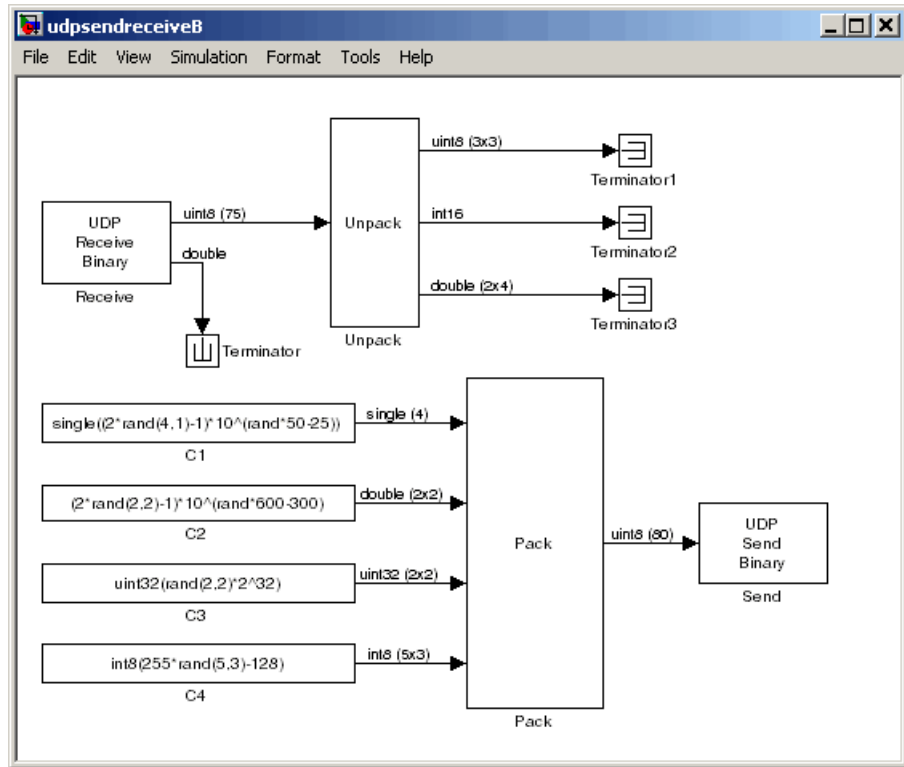

The following table lists the parameters in udpsendreceiveB.

| Block | Parameter             | Value                                  |
|-------|-----------------------|----------------------------------------|
| Pack  | Input port data types | {'single', 'double', 'uint32', 'int8'} |
|       | Byte alignment        | 2                                      |
| Send  | IP address            | 192.168.0.1                            |
|       | IP port               | 25000                                  |
|       | Sample time           | 0.01                                   |

# Aerospace I/O Support

---

xPC Target interfaces the target PC to an ARINC 429 bus using the ARINC 429 blocks provided by the xPC Target I/O block library. The xPC Target ARINC 429 blocks work with the Condor Engineering CEI-X20 series boards (<http://www.condoreng.com>). This chapter includes the following sections

Condor (p. 7-2)

PCI board series that interfaces target PCs to ARINC 429 data buses

## Condor

The commercial and aircraft transport industry uses the ARINC 429 protocol. The Aerospace ARINC-429 driver library allows xPC Target applications to connect to an ARINC bus network to send and receive 32-bit words. This chapter assumes that you are familiar with the ARINC 429 standard.

xPC Target supports the ARINC 429 protocol with the following Condor boards. These board interface a target PC to an ARINC 429 data bus. These boards support the PCI bus.

- CEI-520
- CEI-520A

xPC Target provides the following driver blocks to support these boards:

- “Condor CEI-x20 Initialize” on page 7-3
- “Condor CEI-x20 Send” on page 7-4
- “Condor CEI-x20 Receive” on page 7-5

Use the following utility blocks to format the data sent to and received from the CEI-x20 Send and Receive blocks:

- “Encode ARINC 429 Words for Send” on page 7-6
- “Decode ARINC 429 Words from Receive” on page 7-9

## Board Characteristics

|                                 |                   |
|---------------------------------|-------------------|
| Board name                      | CEI-520, CEI-520A |
| Manufacturer                    | Condor            |
| Bus type                        | PCI               |
| Access method                   | Memory mapped     |
| Multiple block instance support | No                |
| Multiple board support          | Yes               |

## Condor CEI-x20 Initialize

Your model must include a CEI-x20 Initialize block for every physical board in the model. configure your Send and Receive blocks with the appropriate board ID value from this block to identify the physical board to which they refer. This block supports up to 16 CEI-x20 boards.

### Driver Block Parameters

**Board ID** — From the list, select from 1 to 16 a unique ID for the CEI board. Use this ID to identify the board in the associated Send and Receive blocks in your model.

**Wrap each send channel to the corresponding receive channel** — Select this check box to enable the hardware loopback feature. If this block is selected, each word sent over the output channel *n* will be received on the input channel *n*.

**Timer tick length** — Specify the length of a timer tick in .25 microsecond units. The default value is 4000, which results in a tick length of one millisecond. Time tags (if selected from a Decode ARINC 429 Words from Receive block) are provided in units of timer ticks. A timer tick specifies the units in which the time the time tags is expressed. This concept is provided as a convenience to users.

**Sample time** — Base sample time or a multiple of the base sample time.

**PCI Slot (-1:autosearch)** — If only one board of this type is physically present in the target PC, enter

to automatically locate the board.

If two or more boards of this type are physically present in the target PC, enter the bus number and the PCI slot number of the board associated with this driver block. Use the format [BusNumber, SlotNumber]. To determine the bus number and the PCI slot number, type

```
getxpcpci
```

## Condor CEI-x20 Send

Use this block to set up one channel of a board to send 32-bit words. The number of channels varies depending on the board you have.

### Driver Block Parameters

**Board ID** — From the list, select a unique ID from 1 to 16 for the CEI board. Use the ID previously assigned by the associated Initialize block in the model. If you are using a corresponding Receive block for this Send block, select the same board ID as you enter here.

**Channel** — From the list, select a channel ID. This number varies with the particular board you are using. Check your board manufacturer documentation for the number of channels in the board. If you try to select a non-existent channel, the block returns an error.

**Baud rate** — From the list, select

- 12.5 Kbits/sec
- 100 Kbits/sec

If you are using a corresponding Receive block, be sure to select the same baud rate setting for this channel.

**Parity** — From the list, select

- odd
- none

---

**Note** If you are using a corresponding Receive block, be sure to select the same parity setting for this channel.

---

**Sample time** — Base sample time or a multiple of the base sample time.

## Condor CEI-x20 Receive

Use this block to set up one channel of a board to receive 32-bit words. The number of channels varies depending on the board you have.

---

**Note** The output port of a Receive block is a signal of type double, but the data on this port is encoded in a nonstandard way. Normally, you should feed this output port into an ARINC Decode block (which converts the data into standard double output). You can also feed it into blocks such as MUX blocks which do not interpret the data. However, before feeding this port into a block such as an xPC Target Scope block which does interpret the data, you must first pass it through an ARINC Decode block.

---

### Driver Block Parameters

**Board ID** — From the list, select a unique ID from 1 to 16 for the CEI board. Use the ID previously assigned by the associated Initialize block in the model. If you are using a corresponding Send block, be sure to enter the same board ID.

**Channel** — From the list, select a channel number. The number of channels supported varies with the particular board you are using. Check your board manufacturer documentation for the number of channels in the board.

**Max number of words to return** — Enter the maximum number of words to extract from the hardware receive buffer. This is the maximum number of words for the selected channel at each sample time.

If you select  $n$ , the output port of the block will have a signal width of  $n+1$  and the first signal element will contain the count of words actually extracted from the buffer during the current sample time.

**Min number of words to return** — Enter the minimum number of words to extract from the hardware receive buffer. This is the minimum number of words for the selected channel at each sample time.

If the hardware receive buffer does not contain this minimum number of words for the selected channel during the current sample time, the block extracts no

words from the hardware receive buffer. The word count associated with the output port would then be 0.

**Baud rate** — From the list, select

- 12.5 Kbits/sec
- 100 Kbits/sec

If you are using a corresponding Send block, be sure to select the same baud rate setting for this channel.

**Parity** — From the list, select

- odd
- none

If you are using a corresponding Send block, be sure to select the same parity setting for this channel.

**Sample time** — Base sample time or a multiple of the base sample time.

## **Encode ARINC 429 Words for Send**

The output port of an Encode block is a signal of type double. Because the Encode block encodes the data on this port in a nonstandard way, you must send this data to one of the following:

- Condor CEI-520A Send block — The ARINC Send block converts the data into standard double output. This is the block to which you will most likely send data from the ARINC Encode block.
- MUX block — The MUX block does not interpret the data. After the MUX block, you can send it to an ARINC Send block.



## Driver Block Parameters

**Label** — Enter a three digit octal number as the label. The label field of each ARINC word sent over the output port will contain this value.

**Data type vector** — Enter a vector consisting of values between 0 and 3. These values specify the data type. The length of this vector determines the widths of both the input and output ports. The data type determines how the input double value is converted to a corresponding ARINC value, as follows

| Type | Interpretation                                                                                                                                                                                                                                                                                |
|------|-----------------------------------------------------------------------------------------------------------------------------------------------------------------------------------------------------------------------------------------------------------------------------------------------|
| 0    | Raw — Cast the input to an unsigned 32-bit integer and output it as an ARINC word with no further processing.                                                                                                                                                                                 |
| 1    | BNR (two's complement binary notation) — Cast the input as a signed integer, clamp it to lie in the range representable by a signed 19-bit binary integer, and pack it into an ARINC word with the appropriate Sign/Status Matrix (SSM), Source/Destination Identifier (SDI), and Label data. |
| 2    | BCD (binary coded decimal) — Cast the input as a signed integer, clamp it to lie in the range representable by an ARINC five character BCD value, and pack it into an ARINC word with the appropriate SSM, SDI, and Label data.                                                               |
| 3    | Discretes — Cast the input as an unsigned 32-bit integer and pack the low order 19 bits of the result into an ARINC word with the appropriate SSM, SDI, and Label data.                                                                                                                       |

**Resolution vector** — Enter a vector or scalar value as the resolution vector. This must be a vector of the same length as the **data type vector**. Otherwise,

the scalar value is applied to the length of the **data type vector**. The block works with the data types as follows

| Type      | Effect                                                                                                                                                                                                                                                                                                                                                                                                                                                                                                                                                 |
|-----------|--------------------------------------------------------------------------------------------------------------------------------------------------------------------------------------------------------------------------------------------------------------------------------------------------------------------------------------------------------------------------------------------------------------------------------------------------------------------------------------------------------------------------------------------------------|
| Raw       | The block ignores any resolution value. However, you must still include an associated value in the resolution vector.                                                                                                                                                                                                                                                                                                                                                                                                                                  |
| BNR       | <p>The resolution value specifies, in the same units as the input signal, the value of the least significant bit of the binary data field. For example, if the associated resolution value is 10 and the input signal contains the value 1000, the output ARINC word will contain the binary number 100 in its data field.</p> <p>A 19-bit signed ARINC binary can represent a range from -262,144 to 262,143. If the combination of input signal and resolution produces a value outside this range, the block clamps it to lie within the range.</p> |
| BCD       | <p>The resolution value specifies, in the same units as the input signal, the value of the least significant digit of the BCD data field. For example, if the associated resolution is 10 and the input signal contains the value 1000, the output ARINC word will contain the number 100 in its data field, encoded in BCD.</p> <p>The range representable as an ARINC BCD value is -79,999 to 79,999. If the combination of input signal and resolution produces a value outside this range, the block clamps it to lie within the range.</p>        |
| Discretes | The block ignores any resolution value. However, you must still include an associated value in the resolution vector.                                                                                                                                                                                                                                                                                                                                                                                                                                  |

**SDI vector** — Enter a vector or scalar value as the SDI vector. This must be a vector of the same length as the **data type vector**. Otherwise, the scalar value is applied to the length of the **data type vector**.

This block interprets the **SDI vector** values as follows:

| Type                | Effect                                                                                                                                                                                                                              |
|---------------------|-------------------------------------------------------------------------------------------------------------------------------------------------------------------------------------------------------------------------------------|
| Raw                 | The block ignores any resolution value. However, you must still include an associated value in the resolution vector.                                                                                                               |
| BNR, BCD, Discretes | If the SDI element is in the range 0 to 3, the block sets the SDI field of the corresponding output word to that value. If an SDI element has a value of -1, the block performs no SDI processing on the corresponding output word. |

**SSM vector** — Enter a vector or scalar value as the SDI vector. This must be a vector of the same length as the **data type vector**. Otherwise, the scalar value is applied to the length of the **data type vector**.

If the SSM element is in the range 0 to 3, the block sets the SSM field of the corresponding output word to that value. If an SSM element has a value of -1, the block performs no SSM processing on the corresponding output word. Note that the meaning of a given SSM value differs depending on the data type of the ARINC word.

## Decode ARINC 429 Words from Receive

The input port of a Decode block is a signal of type double. Because the Decode block interprets the data on this port in a nonstandard way, you can send the data to this port from one of the following:

- Condor CEI-520A Receive block — The Condor CEI-520A Receive block outputs its data into standard double output. This is the block from which you will most likely send data to the ARINC Decode block.
- ARINC Encode block — The output port of an Encode block is a signal of type double.

The output port of a Decode block is in standard double format.

The input to this block should be a CEI-x20 Receive block. The Decode block input port width will automatically adapt to that of the source block. connected width of the input port of the block adjusts to the block it is connected to.

### Driver Block Parameters

**Label** — Enter a three digit octal number. If the label of an input word does not match this label, the block completely ignores the word and does not apply the **Sync mask** and **Sync value** parameters.

**Data type vector** — Enter a vector consisting of values between 0 and 3. These values specify the data type. The length of this vector determines how many ARINC words the block will attempt to decode and output each sample time. The elements of the vector determine how the input double value is converted to a corresponding double output value, as follows

| Type | Interpretation                                                                                     |
|------|----------------------------------------------------------------------------------------------------|
| 0    | Raw — Convert the entire (unsigned) 32 bit input word to double.                                   |
| 1    | BNR — For each word, convert bits 10-28 from signed binary format to double.                       |
| 2    | BCD — For each word, convert bits 10-28 from BCD format to double, using the sign data in the SSM. |
| 3    | Discretes — For each word, extract bits 10-28 and return them as a double.                         |

The elements of the data type vector determine how the input ARINC value is converted to a corresponding double output. The following describes how this block performs the conversion. For the purposes of this description,  $n$  denotes the length of the data type vector.

- The output width is one of the following, depending on your time tag selection
  - $2n + 1$  — This is the output width if you select the **Provide time tags** check box. The width consists of a count element, followed by  $n$  data elements, followed by  $n$  time tag elements.
  - $n + 1$  — This is the output width if you do not select the **Provide time tags** check box. The width consists of a count element followed by  $n$  data elements.

The count element indicates how many valid messages the block has decoded during the current sample time. The count element has a nonzero value if a

at least one message on the data element is currently valid, and zero otherwise. If the count element has a value greater than one, the block asserts only the most recent valid message on the output port.

- The Decode block buffers its input internally. It updates its output port only during sample times when it has successfully assembled at least one complete message of length  $n$ .

Note that more than one complete message might be assembled during one sample time. The Decode block successively overwrites these messages such that only the most recent message is on the output port.

**Resolution vector** — Enter a vector or scalar value as the resolution vector. This must be a vector of the same length as the **data type vector**. Otherwise, the scalar value is applied to the length of the **data type vector**. The block works with the data types as follows

| Type      | Effect                                                                                                                                                                                                                                          |
|-----------|-------------------------------------------------------------------------------------------------------------------------------------------------------------------------------------------------------------------------------------------------|
| Raw       | The block ignores any resolution value. However, you must still include an associated value in the resolution vector.                                                                                                                           |
| BNR, BCD  | The resolution value specifies, in output port units, the value of the least significant bit of the data field. For example, if the resolution is 10 and the input data contains the value 100, the output signal will contain the number 1000. |
| Discretes | The block ignores any resolution value. However, you must still include an associated value in the resolution vector.                                                                                                                           |

**Sync mask** — Enter a value, in hexadecimal, to specify which bits (if any) of the input words are the sync bits. (A sync bit lets you specify, using other parameters, when a message should begin.) The Decode block will examine these bits to look for the start of the next message. A message might be a string of one or more words. For example, a sync mask value of 0x300 equals 110000000 in binary. This value selects the SDI bits (bits 9 and 10) as the sync bits. This functionality works in conjunction with the **Sync value** parameter.

If the sync mask is 0x0, no sync logic is used. In this case, the next word always begins a new message.

**Sync value(s)** — This parameter specifies the sync logic for the block. Enter one hex value to specify oneSync, two hex values separated by a space for twoSync logic. For example, the sync value

0x100

selects oneSync logic. The sync value

0x100 0x200

selects twoSync logic. You can enter an 32-bit value.

The sync value takes into account the value of the sync mask, as follows:

- Assume the following

sync mask = 0x300

sync value = 0x100

When looking for the beginning of a new message, the block ANDs each input word with the sync mask 0x300 and compares the result with 0x100 and 0x300. When it finds a match, the block stops this search and begins a new search, looking for the next message. The block decodes the next  $n$  words starting at this point.

- Assume the following

sync mask = 0x300

sync value = 0x100 0x200

When looking for the beginning of a new message, the block ANDs each input word with 0x300 and compares the result to 0x100 and 0x300. When the block finds a match, and when the next input word, when ANDed with 0x300, equals 0x200 and 0x300, this second word begins a new message.

Once the block locates the beginning of a message, it uses the next  $n$  input words with the appropriate label to assemble the next output message. The block does not use sync logic until it is time to begin the assembly of a new message.

**Provide time tags** — Select this check box to enable an output port of width  $2n + 1$ , with time tag data in the last  $n$  elements.

# Access IO

---

This chapter describes I/O boards supported by xPC Target (<http://www.accessio.com>).

WDG-CSM (p. 8-2)

The WDG-CSM is a watchdog timer used to detect computer failure.

## WDG-CSM

The WDG-CSM is a watchdog timer used to detect computer failure. You can program this watchdog to reboot the system when a programmable timeout occurs. The timeout interval can range from 20 microseconds to 400 seconds.

xPC Target supports this board with one driver block:

- “WDG-CSM Watchdog Timer” on page 8-2

### Board Characteristics

|                                 |            |
|---------------------------------|------------|
| Board name                      | WDG-CSM    |
| Manufacturer                    | Access IO  |
| Bus type                        | ISA        |
| Access method                   | I/O mapped |
| Multiple block instance support | No         |
| Multiple board support          | Yes        |

## WDG-CSM Watchdog Timer

### Driver Block Parameters

**Watchdog Time [s] (20us-4800s)** — Enter a timeout value in seconds.

**Show reset port** — Select this check box to enable an input port on the driver block. A signal connected to this port resets the watchdog.

**Sample time** — Base sample time or a multiple of the base sample time.

**Base address** — Enter the base address of the board. It is important that this entry corresponds to the DIP switch settings on the board. For example, if the base address is 300 (hexadecimal), enter

0x300



# ADDI-DATA

---

This chapter describes I/O boards supported by xPC Target (<http://www.addi-data.de>).

APCI-1710 (p. 9-2)

The APCI-1710 is a general-purpose counting board with four function modules.

PA-1700 (p. 9-5)

The PA1700 is a counter board with three 24-bit counters for connecting three incremental encoders.

## APCI-1710

The APCI-1710 is a general-purpose counting board with four function modules.

xPC Target supports this board with this driver block:

- “APCI-1710 Incremental Encoder” on page 9-2

Note, xPC Target only supports the 32-bit mode for this board. As a result, each port only supports a single encoder.

### Board Characteristics

|                                 |            |
|---------------------------------|------------|
| Board name                      | APCI-1710  |
| Manufacturer                    | ADDI-DATA  |
| Bus type                        | PCI        |
| Access method                   | I/O mapped |
| Multiple block instance support | Yes        |
| Multiple board support          | Yes        |

### APCI-1710 Incremental Encoder

A function module is individually programmable with different firmware. You do this by using the ADDI-DATA utility SET1710. This driver supports the APCI-1710 if the specified function module is programmed with the incremental encoder firmware.

If the board and its specific module are not programmed with the incremental encoder firmware, you must invoke SET1710 before the driver can be used within an xPC Target application. In this case, plug the board into a PC running Microsoft Windows and install the board as indicated in the ADDI-DATA user manual. Use SET1710 to download the incremental encoder firmware onto the appropriate function module. After this step, you can remove the board and plug it into the target PC.

This driver block has two block outputs. The values output depend on the value of the **Type of Evaluation** parameter. See below for further information. Refer

to the APCI-1710-manual for information on how to connect the encoders to the board.

### Driver Block Parameters

**Function module** — From the list select 1, 2, 3, or 4. This field specifies the function module (counter) to be used for this block. It must be programmed with the incremental encoder firmware. Two blocks for the same board cannot have the same module (channel) specified.

**Type of evaluation** — From the list select the type of counter evaluation as either

- **Virtual Absolute** — Gets the counter value as an absolute value after the reference point of the encoder has been reached for the first time. The first output of the block outputs the absolute angle of the connected encoder in radians. As long as the reference point has not been reached for the first time, the second block output is zero. If the reference point is reached for the first time, and only for the first time, the corresponding counter is reset to zero and the second output goes to 1. From then on the output 1 outputs an absolute angle even if the encoder is turned multiple times. The second output can be used for controlling or switching different Simulink submodels.
- **Reset and Index Output Up-Dating** — Gets the counter value in the range of  $0..2*\pi$  or  $-\pi..+\pi$  where the counter is reset every time the reference point is reached. The first output of the block outputs the angle of the connected encoder in radian. As long as the reference point has not been reached for the first time, the second block output is zero. Every time the reference point is reached, the counter is reset to zero and, depending on the direction of the encoder at this event, the output value is either incremented or decremented by the value 1. In other words the second output outputs the actual number of turns  $n$  because the reference point has been reached for the first time. If the second output is multiplied by  $2*\pi$  and added to the value of the first output, you get an absolute multiturn angle, even if the counter is reset periodically.

**Mode** — From the list, choose single, double, or quadruple. This parameter specifies the phase detection mode, that is, how many phase changes of the specified module are detected (see the APCI-1710 manual).

**Hysteresis** — From the list choose either off or on. The **Hysteresis** parameter specifies whether a counter should skip a tick if the direction changes (see the APC1-1700 manual).

**Resolution** — Specifies the resolution of the connected incremental encoder for one revolution.

**Sample time** — Model base sample time or a multiple of the base sample time.

**PCI Slot (-1:autosearch)** — If only one board of this type is physically present in the target PC, enter

-1

to automatically locate the board.

If two or more boards of this type are physically present in the target PC, enter the bus number and the PCI slot number of the board associated with this driver block. Use the format [BusNumber, SlotNumber]. To determine the bus number and the PCI slot number, type

```
getxpcpci
```

## PA-1700

The PA1700 is a counter board with three 24-bit counters for connecting three incremental encoders.

xPC Target supports this board with this driver block:

- “PA-1700 Incremental Encoder” on page 9-5

### Board Characteristics

|                                 |            |
|---------------------------------|------------|
| Board name                      | PA1700     |
| Manufacturer                    | ADDI-DATA  |
| Bus type                        | ISA        |
| Access method                   | I/O mapped |
| Multiple block instance support | Yes        |
| Multiple board support          | Yes        |

### PA-1700 Incremental Encoder

The driver block has two block outputs. The first outputs the absolute angle in radians. The second output is zero as long as the index or the reference point was not reached by rotating the encoder. If it is reached for the first time, and only for the first time, the corresponding counter is reset to zero and this output goes to 1. From then on the output 1 outputs an absolute angle even if the encoder is turned multiple times. The second output can be used for controlling or switching different Simulink submodels.

#### Driver Block Parameters

**Counter** — From the list select 1, 2, or 3. This parameter specifies the counter used for this block. Two blocks for the same board (same base address) cannot have the same counter (channel) specified.

**Mode** — From the list select `single`, `double`, or `quadruple`. This parameter specifies the phase detection mode, that is, how many phase changes of the specified counter are detected (see the PA1700 manual).

**Hysteresis** — From the list choose either off or on. The Hysteresis parameter specifies whether a counter should skip a tick if the direction changes (see the PA1700 manual).

**Resolution** — Specifies the resolution of the connected incremental encoder for one revolution.

**Sample time** — Model base sample time or a multiple of the base sample time.

**Base Address** — Enter the base address of the board. It is important that this entry corresponds to the DIP switch settings on the board. For example, if the base address is 300 (hexadecimal), enter

0x300

The following jumpers must be set according to the parameters entered above:

- Jumper J16, 17, and 18 must be set to position 1-2.
- Jumper J13, 14, and 15 must be set to position 1-2.
- Jumper J1, 5, and 9 must be set according to the connected encoders.
- Jumper J2, 6, and 10 must be set according to the connected encoders.
- Jumper J3, 7, and 11 must be set according to the connected encoders.
- Jumper J4, 8, and 12 must be set according to the connected encoders.

For information on how to connect the encoders to the board, see the PA1700 manual.

If you want to use the 5 V power supply from the board (PIN20), you must insert Fuse 1 on the board. Refer to the PA1700 manual.

# Adlink

---

This chapter describes the Adlink boards supported by xPC Target (<http://www.adlinktech.com>).

Adlink PCI-8133 (p. 10-2)

Three-phase encoder counter and PWM output board

Adlink PCI-6208A (p. 10-5)

Digital to analog converter board with four bits of digital input and four bits of digital output lines.

## Adlink PCI-8133

The Adlink PCI-8133 is a three-phase encoder counter and PWM output board. This board has three 16-bit quadruple AB phase encoder counters, 12-bit PWM resolution, and eight general-purpose digital input and output lines.

xPC Target supports the three-phase PWM generation section of the board with this driver block:

- “PCI-8133 3-Phase PWM” on page 10-2

### Board Characteristics

|                                 |            |
|---------------------------------|------------|
| Board name                      | PCI-8133   |
| Manufacturer                    | Adlink     |
| Bus type                        | PCI        |
| Access method                   | I/O mapped |
| Multiple block instance support | No         |
| Multiple board support          | No         |

### PCI-8133 3-Phase PWM

#### Scaling Output to Input

| Hardware Output | Block Input Data Type | Scaling |
|-----------------|-----------------------|---------|
| TTL             | Duty cycle: double    | 0 to 1  |

#### Of Note

- There is one input port for each phase (channel). You can select and order each phase (channel) individually.
- Hardware outputs are open collector lines that can draw a maximum current of 20 mA.
- To enable PWM generation, ensure that the OENA pin (pin 34 of connector CN1) is connected to pin VCC (pin 19 of connector CN1).



- Although the duty cycle inputs are of type double, the duty cycle resolution is finite. The value of the **Factor n determining square wave period** parameter defines the duty cycle resolution. For example, if the value of **Factor n determining square wave period** is 1000 for an output period of 200 microseconds, the duty cycle can be adapted with a resolution of 1000 steps (from 0...1), in relation to the value of **Factor n determining square wave period**. The duty cycle resolution lowers by a smaller output period (or higher output frequency).

### Driver Block Parameters

**Factor n determining square wave period** — Defines the period (duration) of the square wave, where the square wave is the sum of the on and off part. This parameter is also called the n factor. The n factor must be in the range from 1 to 65535. The resulting period is calculated as

$$T=n*200 \text{ nanoseconds}$$

**Factor m determining dead time duration** — Defines the duration of the dead time that is needed if the output lines drive transistor bridges. This parameter is also called the m factor. The m factor must be in the range from 1 to 255. The resulting duration is calculated as

$$Tdt= 750 \text{ nanoseconds}*(m+1)$$

**Channel vector** — Defines the channel (phase) that is active. Enter a vector of numbers between 1 and 3 to This parameter also specifies the input port of the block is connected to the channel. Channel value 1 represents phase U, value 2 represents phase V, and value 3 represents phase W. The maximum length of the vector is 3.

**Reset vector** — Enter a scalar or a vector that is the same length and channel order as the **Channel vector** value. Enter 1 or 0. A value of 1 resets the output. A value of 0 retains the last value of the duty cycle when the target application stops. You can specify a different reset vector value for each channel.

**Initial duty cycle vector** — Enter a scalar or a vector that is the same length and channel order as the **Channel vector** value. Enter 1 or 0. A value of 1 sets the reset duty cycle for the corresponding channel if the **Reset vector** for that channel is also 1.

**Sample time** — Base sample time or a multiple of the base sample time.

**PCI slot** — If only one board of this type is physically present in the target PC, enter

-1

to automatically locate the board.

If two or more boards of this type are physically present in the target PC, enter the bus number and the PCI slot number of the board associated with this driver block. Use the format [BusNumber, SlotNumber]. To determine the bus number and the PCI slot number, type

`getxpcpci`

## Adlink PCI-6208A

The Adlink PCI-6208A is a digital to analog converter board. This board has four bits of digital input and four bits of digital output lines.

xPC Target supports this board with the following driver blocks:

- “PCI-6208A Analog Output” on page 10-5
- “PCI-6208A Digital Input” on page 10-7
- “PCI-6208A Digital Output” on page 10-8

### Board Characteristics

|                                 |            |
|---------------------------------|------------|
| Board name                      | PCI-6208A  |
| Manufacturer                    | Adlink     |
| Bus type                        | PCI        |
| Access method                   | I/O mapped |
| Multiple block instance support | No         |
| Multiple board support          | Yes        |

## PCI-6208A Analog Output

### Scaling Output to Input

| Hardware Output | Block Input Data Type | Scaling |
|-----------------|-----------------------|---------|
| ma              | Double                | 1       |

**Channel vector** — Enter a vector of numbers to specify the output channels.

For example, to use the first and second analog output (D/A) channels enter

[1, 2]

The channel numbers can occur in any order. Number the channels beginning with 1 even though the board manufacturer numbers them beginning with 0. The maximum allowable channel number is 4.

**Range** — From the list, choose

- 0 to 20 ma
- 5 to 25 ma
- 4 to 20 ma

Signal input to the block is in milliamps (ma). The output voltage maximum is 10 volts. If the resistance is too large to get the chosen current, the voltage measured across the output load will saturate.

For example, assume an input sine wave with:

$$\text{Input} = 10 * \sin(\omega * t) + 10$$

If you set the range to 0 to 20 ma, the current should oscillate from 0 to 20 ma at  $\omega$  radians per second. The current will only reach 20 ma if the load resistance is less than or equal to 500 ohms. If the load resistance is 1000 ohms, the maximum current that 10 volts can drive is only 10 ma. The top half of the sine wave will be clipped off.

Note the following:

- The scaling in this block is correct for the current output ports, not the voltage ones.
- This block limits output to positive values only. This is in response to the board hardware manual caution that states driving a negative voltage from the D/A converter to the voltage to current output board might cause damage to the current output.

**Reset vector** — The reset vector controls the behavior of the channel at model termination. Enter a scalar or a vector that is the same length as the channel vector. If you specify a scalar value, that setting is used for all channels. If you specify a value of 1, the corresponding channel is reset to the value specified in the initial value vector. If you specify a value of 0, the channel remains at the last value attained while the model was running. For example, if **Channel vector** is [1 2] and the **Reset vector** is [1], the action taken will be the same as if Reset vector was set to [1 1]. Both channels will be reset to their initial values when model execution is stopped.

**Initial value vector** — The initial value vector contains the initial voltage values for the output channels. Enter a scalar or a vector that is the same length as the channel vector. If you specify a scalar value, that value is the initial value for all channels. The channels are set to the initial values between

the time the model is downloaded and the time it is started. When model execution is stopped, the corresponding position in **Reset vector** is checked. Depending on that value, the channel is either reset to the initial value or remains at the last value attained while the model was running. For example, assume that **Channel vector** is [ 1 2 ], **Reset vector** is [ 1 0 ], and **Initial value vector** is [ 2.3 5.6 ]. On initial download, channel 1 is set to 2.3 ma and channel 2 to 5.6 ma. When the model is stopped, channel 1 resets to 2.3 ma and channel 2 remains at the last value attained.

**Sample time** — Base sample time or a multiple of the base sample time.

**PCI slot** — If only one board of this type is physically present in the target PC, enter

-1

to automatically locate the board.

If two or more boards of this type are physically present in the target PC, enter the bus number and the PCI slot number of the board associated with this driver block. Use the format [ BusNumber , SlotNumber ]. To determine the bus number and the PCI slot number, type

getxpcpci

## PCI-6208A Digital Input

### Scaling Input to Output

| Hardware Input | Block Output Data Type | Scaling                     |
|----------------|------------------------|-----------------------------|
| TTL            | Double                 | TTL low = 0<br>TTL high = 1 |

**Channel vector** — Enter a vector of numbers to specify the digital input port ports.

For example, to use the first and second digital input channels enter

[ 1, 2 ]

The channel numbers can occur in any order. Number the channels beginning with 1 even though the board manufacturer numbers them beginning with 0. The maximum allowable channel number is 4. Each input can be listed at most once in this vector.

**Sample time** — Base sample time or a multiple of the base sample time.

**PCI slot** — If only one board of this type is physically present in the target PC, enter

-1

to automatically locate the board.

If two or more boards of this type are physically present in the target PC, enter the bus number and the PCI slot number of the board associated with this driver block. Use the format [BusNumber, SlotNumber]. To determine the bus number and the PCI slot number, type

```
getxpcpci
```

## PCI-6208A Digital Output

### Scaling Input to Output

| Hardware Output | Block Input Data Type | Scaling                                    |
|-----------------|-----------------------|--------------------------------------------|
| TTL             | Double                | $\leq 0.5$ = TTL low<br>$> 0.5$ = TTL high |

**Channel vector** — Enter a vector of numbers to specify the digital output channels.

For example, to use the first and second analog digital output channels enter

```
[1, 2]
```

The channel numbers can occur in any order. Number the channels beginning with 1 even if the board manufacturer numbers them beginning with 0. The maximum allowable channel number is 8.

**Reset vector** — The reset vector controls the behavior of the channel at model termination. Enter a scalar or a vector that is the same length as the channel vector. If you specify a scalar value, that setting is used for all channels. If you specify a value of 1, the corresponding channel is reset to the value specified in the initial value vector. If you specify a value of 0, the channel remains at the last value attained while the model was running. For example, if **Channel vector** is [ 1 2 ] and the **Reset vector** is [ 1 ], the action taken will be the same as if Reset vector was set to [ 1 1 ]. Both channels will be reset to their initial values when model execution is stopped.

**Initial value vector** — The initial value vector contains the initial voltage values for the digital output channels. Enter a scalar or a vector that is the same length as the channel vector. If you specify a scalar value, that value is the initial value for all channels. The channels are set to the initial values between the time the model is downloaded and the time it is started. When model execution is stopped, the corresponding position in **Reset vector** is checked. Depending on that value, the channel is either reset to the initial value or remains at the last value attained while the model was running. For example, assume that **Channel vector** is [ 1 2 ], **Reset vector** is [ 1 0 ], and **Initial value vector** is [ 0 1 ]. On initial download, channel 1 is set to off and channel 2 to on. When the model is stopped, channel 1 resets to off and channel 2 remains at the last value attained.

If the **Initial value vector** value is greater than 0.5, the corresponding digital output port is turned on, otherwise it is turned off.

**Sample time** — Base sample time or a multiple of the base sample time.

**PCI slot** — If only one board of this type is physically present in the target PC, enter

-1

to automatically locate the board.

If two or more boards of this type are physically present in the target PC, enter the bus number and the PCI slot number of the board associated with this driver block. Use the format [ BusNumber , SlotNumber ]. To determine the bus number and the PCI slot number, type

```
getxpcpci
```





# Advantech

---

This chapter describes I/O boards supported by xPC Target (<http://www.advantech.com>)

|                      |                                                                                                                                         |
|----------------------|-----------------------------------------------------------------------------------------------------------------------------------------|
| PCL-1800 (p. 11-3)   | 16 single or eight differential analog channels, two analog output D/A channels, and 16 digital input lines and 16 digital output lines |
| PCL-711B (p. 11-8)   | Eight single-ended analog input channels, one analog output channel, and 16 digital input lines and 16 digital output lines             |
| PCL-726 (p. 11-12)   | Six independent analog output D/A channels, and 16 digital input lines and 16 digital output lines                                      |
| PCL-727 (p. 11-16)   | 12 independent analog output D/A channels, 16 digital input lines and 16 digital output lines                                           |
| PCL-728 (p. 11-20)   | Two independent analog output D/A channels                                                                                              |
| PCL-812 (p. 11-22)   | 16 single ended analog input channels, two analog output D/A channels, and 16 digital input lines and 16 digital output lines           |
| PCL-812PG (p. 11-27) | 16 single or eight differential analog channels, two analog output D/A channels, and 16 digital input lines and 16 digital output lines |
| PCL-818 (p. 11-32)   | 16 single or eight differential analog channels, two analog output D/A channels, and 16 digital input lines and 16 digital output lines |
| PCL-818H (p. 11-38)  | 16 single or eight differential analog channels, one analog output D/A channel, and 16 digital input lines and 16 digital output lines  |

PCL-818HD (p. 11-43)

16 single or eight differential analog channels, one analog output D/A channel, and 16 digital input lines and 16 digital output lines

PCL-818HG (p. 11-48)

16 single or eight differential analog input (A/D) channels, one analog output (D/A) channel, and 16 digital input lines and 16 digital output lines

PCL-818L (p. 11-53)

16 single or eight differential analog input (A/D) channels, one analog output (D/A) channel, and 16 digital input lines and 16 digital output lines

## PCL-1800

The PCL-1800 is an I/O board with 16 single or eight differential analog channels (12-bit) with a maximum sample rate of 330 KHz, two analog output D/A channels (12-bit), and 16 digital input lines and 16 digital output lines.

xPC Target supports this board with these driver blocks:

- “PCL-1800 Analog Input (A/D)” on page 11-3
- “PCL-1800 Analog Output (D/A)” on page 11-5
- “PCL-1800 Digital Input” on page 11-6
- “PCL-1800 Digital Output” on page 11-7

### Board Characteristics

|                                 |            |
|---------------------------------|------------|
| Board Name                      | PCL-1800   |
| Manufacturer                    | Advantech  |
| Bus Type                        | ISA        |
| Access Method                   | I/O mapped |
| Multiple block instance support | Yes        |
| Multiple board support          | Yes        |

### PCL-1800 Analog Input (A/D)

#### Scaling of Input to Output

| Hardware Input | Block Output Data Type | Scaling |
|----------------|------------------------|---------|
| volts          | Double                 | 1       |

## Driver Block Parameters

**Channel vector** — If you select 16 channels (**Input coupling** parameter set to Single-ended), enter numbers between 1 and 16. If you select differential (**Input coupling** parameter set to differential), enter numbers between 1 and 8. For example, to use the first and second analog output (A/D) channels, enter

[1,2]

Number the channels beginning with 1 even if the board manufacturer starts the numbering of the channels with 0.

**Range vector** — Enter a range code for each of the channels in the channel vector. The range vector must be the same length as the channel vector. This board allows the range of each channel to be different.

The following table is a list of the ranges for this driver and the corresponding range codes.

| Input Range (V) | Range Code | Input Range (V) | Range Code |
|-----------------|------------|-----------------|------------|
| -10 to +10      | -10        | 0 to 10         | 10         |
| -5 to +5        | -5         | 0 to +5         | 5          |
| -2.5 to +2.5    | -2.5       | 0 to +2.5       | 2.5        |
| -1.25 to +1.25  | -1.25      | 0 to +1.25      | 1.25       |
| -.625 to +.625  | -0.625     |                 |            |

For example, if the first channel is -10 to +10 volts and the second channel is 0 to 5 volts, enter

[-10,5]

The range settings must correspond to the DIP switch settings on the board.

**Input coupling** — From the list, select one from the following list of input modes:

- Single-ended channels (16 channels)
- differential channels (8 channels)

Your choice must correspond to the MUX switch setting on the board.

**Sample time** — Base sample time or a multiple of the base sample time.

**Base address** — Enter the base address of the board. This entry must correspond to the DIP switch settings on the board. For example, if the base address is 300 (hexadecimal), enter

0x300

## PCL-1800 Analog Output (D/A)

### Scaling of Input to Output

| Hardware Output | Block Input Data Type | Scaling |
|-----------------|-----------------------|---------|
| volts           | Double                | 1       |

### Driver Block Parameter

**Channel vector** — Enter numbers between 1 and 2. This driver allows the selection of individual D/A channels in any order. The number of elements defines the number of D/A channels you use. For example, to use the first and second analog output (D/A) channels, enter

[1, 2]

Number the channels beginning with 1 even if the board manufacturer starts numbering the channels with 0.

**Range vector** — Enter a range code for each of the channels in the channel vector. The range vector must be the same length as the channel vector. This board allows the range of each channel to be different.

The following table is a list of the ranges for this driver and the corresponding range codes.

| Input Range (V) | Range Code | Input Range (V) | Range Code |
|-----------------|------------|-----------------|------------|
| 0 to +10        | 10         | 0 to +5         | 5          |

For example, if the first channel is -10 to +10 volts and the second channel is 0 to 5 volts, enter

```
[-10,5]
```

The range settings must correspond to the DIP switch settings on the board.

**Sample time** — Base sample time or a multiple of the base sample time.

**Base address** — Enter the base address of the board. It is important that this entry corresponds to the DIP switch settings on the board. For example, if the base address is 300 (hexadecimal), enter

```
0x300
```

## PCL-1800 Digital Input

### Scaling of Input to Output

| Hardware Input | Block Output Data Type | Scaling                         |
|----------------|------------------------|---------------------------------|
| TTL            | Double                 | TTL low = 0.0<br>TTL high = 1.0 |

### Driver Block Parameters

**Channel vector** — Enter numbers between 1 and 16. This driver allows the selection of individual digital input lines in any order. The number of elements defines the number of digital lines you use.

For example, to use the first eight digital inputs, enter

```
[1,2,3,4,5,6,7,8]
```

Number the lines beginning with 1 even if the board manufacturer starts numbering the lines with 0.

**Sample time** — Enter a base sample time or a multiple of the base sample time.

**Base address** — Enter the base address of the board. This entry must correspond to the DIP switch settings on the board. For example, if the base address is 300 (hexadecimal), enter

0x300

## PCL-1800 Digital Output

### Scaling of Input to Output

| Hardware Output | Block Input Data Type | Scaling                           |
|-----------------|-----------------------|-----------------------------------|
| TTL             | Double                | <0.5 = TTL low<br>≥0.5 = TTL high |

### Driver Block Parameters

**Channel vector** — Enter numbers between 1 and 16. This driver allows the selection of individual digital output lines in any order. The number of elements defines the number of digital lines you use.

For example, to use the first eight digital outputs, enter

[1,2,3,4,5,6,7,8]

Number the lines beginning with 1 even if the board manufacturer starts numbering the lines with 0.

**Sample time** — Enter a base sample time or a multiple of the base sample time.

**Base address** — Enter the base address of the board. This entry must correspond to the DIP switch settings on the board. For example, if the base address is 300 (hexadecimal), enter

0x300

## PCL-711B

The PCL-711B is an I/O board with eight single-ended analog input channels (12-bit) with a maximum sample rate of 25 kHz, one analog output channel (12-bit), and 16 digital input lines and 16 digital output lines.

xPC Target supports this board with four driver blocks:

- “PCL-711B Analog Input (A/D)” on page 11-8
- “PCL-711B Analog Output (D/A)” on page 11-10
- “PCL-711B Digital Input” on page 11-10
- “PCL-711B Digital Output” on page 11-11

### Board Characteristics

|                                 |            |
|---------------------------------|------------|
| Board name                      | PCL-711B   |
| Manufacturer                    | Advantech  |
| Bus type                        | ISA        |
| Access method                   | I/O mapped |
| Multiple block instance support | Yes        |
| Multiple board support          | Yes        |

### PCL-711B Analog Input (A/D)

#### Scaling of Input to Output

| Hardware Input | Block Output Data Type | Scaling |
|----------------|------------------------|---------|
| volts          | Double                 | 1       |

#### Driver Block Parameters

**Channel vector** — Enter numbers between 1 and 8. For example, to use the first and second analog output (A/D) channels, enter

[1,2]



Number the channels beginning with 1 even if the board manufacturer starts numbering the channels with 0.

**Range vector** — Enter a range code for each of the channels in the channel vector. The range vector must be the same length as the channel vector. This board allows the range of each channel to be different.

The following table is a list of the ranges for this driver and the corresponding range codes.

| <b>Input Range (V)</b> | <b>Range Code</b> |
|------------------------|-------------------|
| -10 to +10             | -10               |
| -5 to +5               | -5                |
| -2.5 to +2.5           | -2.5              |
| -1.25 to +1.25         | -1.25             |
| -.625 to +.625         | -0.625            |

For example, if the first channel is -10 to +10 volts, and the second channel is -2.5 to 2.5 volts, enter

[ -10, -2.5 ]

The range settings must correspond to the DIP switch settings on the board.

**Sample time** — Base sample time or a multiple of the base sample time.

**Base address** — Enter the base address of the board. This entry must correspond to the DIP switch settings on the board. For example, if the base address is 300 (hexadecimal), enter

0x300

## PCL-711B Analog Output (D/A)

### Scaling of Input to Output

| Hardware Output | Block Input Data Type | Scaling |
|-----------------|-----------------------|---------|
| volts           | Double                | 1       |

### Driver Block Parameter

**Range** — From the list, choose either 0-10V or 0-5V.

The range settings must correspond to the DIP switch settings on the board.

**Sample time** — Base sample time or a multiple of the base sample time.

**Base address** — Enter the base address of the board. This entry must correspond to the DIP switch settings on the board. For example, if the base address is 300 (hexadecimal), enter

0x300

## PCL-711B Digital Input

### Scaling of Input to Output

| Hardware Input | Block Output Data Type | Scaling                         |
|----------------|------------------------|---------------------------------|
| TTL            | Double                 | TTL low = 0.0<br>TTL high = 1.0 |

### Driver Block Parameters

**Channel vector** — Enter numbers between 1 and 16. This driver allows the selection of individual digital input lines in any order. The number of elements defines the number of digital lines used.

For example, to use the first eight digital inputs, enter

[1,2,3,4,5,6,7,8]

Number the lines beginning with 1 even if the board manufacturer starts numbering the lines with 0.

**Sample time** — Enter a base sample time or a multiple of the base sample time.

**Base address** — Enter the base address of the board. This entry must correspond to the DIP switch settings on the board. For example, if the base address is 300 (hexadecimal), enter

0x300

## PCL-711B Digital Output

### Scaling of Input to Output

| Hardware Output | Block Input Data Type | Scaling                           |
|-----------------|-----------------------|-----------------------------------|
| TTL             | Double                | <0.5 = TTL low<br>≥0.5 = TTL high |

### Driver Block Parameters

**Channel vector** — Enter numbers between 1 and 16. This driver allows the selection of individual digital output lines in any order. The number of elements defines the number of digital lines used.

For example, to use the first eight digital outputs, enter

[1,2,3,4,5,6,7,8]

Number the lines beginning with 1 even if the board manufacturer starts numbering the lines with 0.

**Sample time** — Enter a base sample time or a multiple of the base sample time.

**Base address** — Enter the base address of the board. This entry must correspond to the DIP switch settings on the board. For example, if the base address is 300 (hexadecimal), enter

0x300

## PCL-726

The PCL-726 is an I/O board with, six independent analog output D/A channels (12-bit), 16 digital input lines and 16 digital output lines.

xPC Target supports this board with these driver blocks:

- “PCL-726 Analog Output (D/A)” on page 11-12
- “PCL-726 Digital Input” on page 11-14
- “PCL-726 Digital Output” on page 11-15

### Board Characteristics

|                                 |            |
|---------------------------------|------------|
| Board name                      | PCL-726    |
| Manufacturer                    | Advantech  |
| Bus type                        | ISA        |
| Access method                   | I/O mapped |
| Multiple block instance support | Yes        |
| Multiple board support          | Yes        |

### PCL-726 Analog Output (D/A)

#### Scaling of Input to Output

| Hardware Output | Block Input Data Type | Scaling |
|-----------------|-----------------------|---------|
| volts           | Double                | 1       |

### Driver Block Parameter

**Channel vector** — Enter numbers between 1 and 6. This driver allows the selection of individual D/A channels in any order. The number of elements defines the number of D/A channels you use. For example, to use the first and second analog output (D/A) channels, enter

[ 1, 2 ]

Number the channels beginning with 1 even if the board manufacturer starts numbering the channels with 0.

**Range vector** — Enter a range code for each of the channels in the channel vector. The range vector must be the same length as the channel vector. This board allows the range of each channel to be different.

The following table is a list of the ranges for this driver and the corresponding range codes.

| Input Range (V) | Range Code |
|-----------------|------------|
| 0 to +10        | 10         |
| 0 to +5         | 5          |

For example, if the first channel is -10 to +10 volts, and the second channel is 0 to 5 volts, enter

[ -10, 5 ]

The range settings must correspond to the DIP switch settings on the board.

**Sample time** — Base sample time or a multiple of the base sample time.

**Base address** — Enter the base address of the board. This entry must correspond to the DIP switch settings on the board. For example, if the base address is 300 (hexadecimal), enter

0x300

## PCL-726 Digital Input

### Scaling of Input to Output

| Hardware Input | Block Output Data Type | Scaling                         |
|----------------|------------------------|---------------------------------|
| TTL            | Double                 | TTL low = 0.0<br>TTL high = 1.0 |

### Driver Block Parameters

**Channel vector** — Enter numbers between 1 and 16. This driver allows the selection of individual digital input lines in any order. The number of elements defines the number of digital lines you use.

For example, to use the first eight digital inputs, enter

[1,2,3,4,5,6,7,8]

Number the lines beginning with 1 even if the board manufacturer starts numbering the lines with 0.

**Sample time** — Enter a base sample time or a multiple of the base sample time.

**Base address** — Enter the base address of the board. This entry must correspond to the DIP switch settings on the board. For example, if the base address is 300 (hexadecimal), enter

0x300

## PCL-726 Digital Output

### Scaling of Input to Output

| Hardware Output | Block Input Data Type | Scaling                           |
|-----------------|-----------------------|-----------------------------------|
| TTL             | Double                | <0.5 = TTL low<br>≥0.5 = TTL high |

### Driver Block Parameters

**Channel vector** — Enter numbers between 1 and 16. This driver allows the selection of individual digital output lines in any order. The number of elements defines the number of digital lines you use.

For example, to use the first eight digital outputs, enter

```
[1,2,3,4,5,6,7,8]
```

Number the lines beginning with 1 even if the board manufacturer starts numbering the lines with 0.

**Sample time** — Enter a base sample time or a multiple of the base sample time.

**Base address** — Enter the base address of the board. This entry must correspond to the DIP switch settings on the board. For example, if the base address is 300 (hexadecimal), enter

```
0x300
```

## PCL-727

The PCL-727 is an I/O board with 12 independent analog output D/A channels (12-bit), 16 digital input lines and 16 digital output lines.

xPC Target supports this board with these driver blocks:

- “PCL-727 Analog Output (D/A)” on page 11-16
- “PCL-727 Digital Input” on page 11-18
- “PCL-727 Digital Output” on page 11-19

### Board Characteristics

|                                 |            |
|---------------------------------|------------|
| Board name                      | PCL-727    |
| Manufacturer                    | Advantech  |
| Bus type                        | ISA        |
| Access method                   | I/O mapped |
| Multiple block instance support | Yes        |
| Multiple board support          | Yes        |

## PCL-727 Analog Output (D/A)

### Scaling of Input to Output

| Hardware Output | Block Input Data Type | Scaling |
|-----------------|-----------------------|---------|
| volts           | Double                | 1       |

### Driver Block Parameter

**Channel vector** — Enter numbers between 1 and 12. This driver allows the selection of individual D/A channels in any order. The number of elements defines the number of D/A channels you use. For example, to use the first and second analog output (D/A) channels, enter

[1, 2]



Number the channels beginning with 1 even if the board manufacturer starts numbering the channels with 0.

**Range vector** — Enter a range code for each of the channels in the channel vector. The range vector must be the same length as the channel vector. This board allows the range of each channel to be different.

The following table is a list of the ranges for this driver and the corresponding range codes.

| <b>Input Range (V)</b> | <b>Range Code</b> |
|------------------------|-------------------|
| -5 to +5               | -5                |
| 0 to +5                | 5                 |
| 0 to 10                | 10                |

For example, if the first channel is -10 to +10 volts, and the second channel is 0 to 5 volts, enter

[ -10,5]

The range settings must correspond to the DIP switch settings on the board.

**Sample time** — Base sample time or a multiple of the base sample time.

**Base address** — Enter the base address of the board. This entry must correspond to the DIP switch settings on the board. For example, if the base address is 300 (hexadecimal), enter

0x300

## PCL-727 Digital Input

### Scaling of Input to Output

| Hardware Input | Block Output Data Type | Scaling                         |
|----------------|------------------------|---------------------------------|
| TTL            | Double                 | TTL low = 0.0<br>TTL high = 1.0 |

### Driver Block Parameters

**Channel vector** — Enter numbers between 1 and 16. This driver allows the selection of individual digital input lines in any order. The number of elements defines the number of digital lines you use.

For example, to use the first eight digital inputs, enter

[1,2,3,4,5,6,7,8]

Number the lines beginning with 1 even if the board manufacturer starts numbering the lines with 0.

**Sample time** — Enter a base sample time or a multiple of the base sample time.

**Base address** — Enter the base address of the board. This entry must correspond to the DIP switch settings on the board. For example, if the base address is 300 (hexadecimal), enter

0x300

## PCL-727 Digital Output

### Scaling of Input to Output

| Hardware Output | Block Input Data Type | Scaling                           |
|-----------------|-----------------------|-----------------------------------|
| TTL             | Double                | <0.5 = TTL low<br>≥0.5 = TTL high |

### Driver Block Parameters

**Channel vector** — Enter numbers between 1 and 16. This driver allows the selection of individual digital output lines in any order. The number of elements defines the number of digital lines you use.

For example, to use the first eight digital outputs, enter

```
[1,2,3,4,5,6,7,8]
```

Number the lines beginning with 1 even if the board manufacturer starts numbering the lines with 0.

**Sample time** — Enter a base sample time or a multiple of the base sample time.

**Base address** — Enter the base address of the board. This entry must correspond to the DIP switch settings on the board. For example, if the base address is 300 (hexadecimal), enter

```
0x300
```

## PCL-728

The PCL-728 is an I/O board with two independent analog output D/A channels (12-bit).

xPC Target supports this board with this driver block:

- “PCL-728 Analog Output (D/A)” on page 11-20

### Board Characteristics

|                                 |            |
|---------------------------------|------------|
| Board name                      | PCL-728    |
| Manufacturer                    | Advantech  |
| Bus Type                        | ISA        |
| Access method                   | I/O mapped |
| Multiple block instance support | Yes        |
| Multiple board support          | Yes        |

## PCL-728 Analog Output (D/A)

### Scaling of Input to Output

| Hardware Output | Block Input Data Type | Scaling |
|-----------------|-----------------------|---------|
| volts           | Double                | 1       |

### Driver Block Parameter

**Channel vector** — Enter numbers between 1 and 2. This driver allows the selection of individual D/A channels in any order. The number of elements defines the number of D/A channels you use. For example, to use the first and second analog output (D/A) channels, enter

[1, 2]

Channel numbers begin with 1 even if the board manufacturer starts numbering channels with 0.

**Range vector** — Enter a range code for each of the channels in the channel vector. The range vector must be the same length as the channel vector. This board allows the range of each channel to be different.

The following table is a list of the ranges for this driver and the corresponding range codes.

| Input Range (V) | Range Code |
|-----------------|------------|
| -10 to +10      | -10        |
| -5 to +5        | -5         |
| 0 to 10         | 10         |
| 0 to +5         | 5          |

For example, if the first channel is -10 to +10 volts, and the second channel is 0 to 5 volts, enter

[ -10,5]

The range settings must correspond to the DIP switch settings on the board.

**Sample time** — Base sample time or a multiple of the base sample time.

**Base address** — Enter the base address of the board. This entry must correspond to the DIP switch settings on the board. For example, if the base address is 300 (hexadecimal), enter

0x300

## PCL-812

The PCL-812 is an I/O board with 16 single-ended analog input channels (12-bit) with a maximum sample rate of 30 KHz, two analog output D/A channels (12-bit), and 16 digital input lines and 16 digital output lines.

xPC Target supports this board with these driver blocks:

- “PCL-812 Analog Input (A/D)” on page 11-22
- “PCL-812 Analog Output (D/A)” on page 11-24
- “PCL-812 Digital Input” on page 11-25
- “PCL-812 Digital Output” on page 11-26

### Board Characteristics

|                                 |            |
|---------------------------------|------------|
| Board name                      | PCL-812    |
| Manufacturer                    | Advantech  |
| Bus type                        | ISA        |
| Access method                   | I/O mapped |
| Multiple block instance support | Yes        |
| Multiple board support          | Yes        |

## PCL-812 Analog Input (A/D)

### Scaling of Input to Output

| Hardware Input | Block Output Data Type | Scaling |
|----------------|------------------------|---------|
| volts          | Double                 | 1       |

### Driver Block Parameters

**Channel vector** — Enter numbers between 1 and 16. For example, to use the first and second analog input (A/D) channels, enter

[1,2]

Number the channels beginning with 1 even if the board manufacturer starts numbering the channels with 0.

**Range vector** — Enter a range code for each of the channels in the channel vector. The range vector must be the same length as the channel vector. This board allows the range of each channel to be different.

The following table is a list of the ranges for this driver and the corresponding range codes.

| <b>Input Range (V)</b> | <b>Range Code</b> |
|------------------------|-------------------|
| -10 to +10             | -10               |
| -5 to +5               | -5                |
| -2.0 to +2.0           | -2.0              |
| -1.0 to +1.0           | -1.25             |

For example, if the first channel is -10 to +10 volts, and the second channel is -5 to 5 volts, enter

[ -10, -5]

The range settings must correspond to the DIP switch settings on the board.

**Sample time** — Base sample time or a multiple of the base sample time.

**Base address** — Enter the base address of the board. This entry must correspond to the DIP switch settings on the board. For example, if the base address is 300 (hexadecimal), enter

0x300

## PCL-812 Analog Output (D/A)

### Scaling of Input to Output

| Hardware Output | Block Input Data Type | Scaling |
|-----------------|-----------------------|---------|
| volts           | Double                | 1       |

### Driver Block Parameter

**Channel vector** — Enter numbers between 1 and 2. This driver allows the selection of individual D/A channels in any order. The number of elements defines the number of D/A channels you use. For example, to use the first and second analog output (D/A) channels, enter

[1, 2]

Number the channels beginning with 1 even if the board manufacturer starts numbering the channels with 0.

**Range vector** — Enter a range code for each of the channels in the channel vector. The range vector must be the same length as the channel vector. This board allows the range of each channel to be different.

The following table is a list of the ranges for this driver and the corresponding range codes.

| Input range | Range code |
|-------------|------------|
| 0 to +5V    | 5          |

For example, if both channels are 0 to +5 volts, enter

[5,5]

The range settings must correspond to the DIP switch settings on the board.

**Sample time** — Base sample time or a multiple of the base sample time.



**Base address** — Enter the base address of the board. This entry must correspond to the DIP switch settings on the board. For example, if the base address is 300 (hexadecimal), enter

0x300

## PCL-812 Digital Input

### Scaling of Input to Output

| Hardware Input | Block Output Data Type | Scaling                         |
|----------------|------------------------|---------------------------------|
| TTL            | Double                 | TTL low = 0.0<br>TTL high = 1.0 |

### Driver Block Parameters

**Channel vector** — Enter numbers between 1 and 16. This driver allows the selection of individual digital input lines in any order. The number of elements defines the number of digital lines used.

For example, to use the first eight digital inputs, enter

[1,2,3,4,5,6,7,8]

Number the lines beginning with 1 even if the board manufacturer starts numbering the lines with 0.

**Sample time** — Enter a base sample time or a multiple of the base sample time.

**Base address** — Enter the base address of the board. This entry must correspond to the DIP switch settings on the board. For example, if the base address is 300 (hexadecimal), enter

0x300

## PCL-812 Digital Output

### Scaling of Input to Output

| Hardware Output | Block Input Data Type | Scaling                           |
|-----------------|-----------------------|-----------------------------------|
| TTL             | Double                | <0.5 = TTL low<br>≥0.5 = TTL high |

### Driver Block Parameters

**Channel vector** — Enter numbers between 1 and 16. This driver allows the selection of individual digital output lines in any order. The number of elements defines the number of digital lines used.

For example, to use the first eight digital outputs, enter

```
[1,2,3,4,5,6,7,8]
```

Number the lines beginning with 1 even if the board manufacturer starts numbering the lines with 0.

**Sample time** — Enter a base sample time or a multiple of the base sample time.

**Base address** — Enter the base address of the board. This entry must correspond to the DIP switch settings on the board. For example, if the base address is 300 (hexadecimal), enter

```
0x300
```

## PCL-812PG

The PCL-812PG is an I/O board with 16 single or eight differential analog channels (12-bit) with a maximum sample rate of 30 KHz, two analog output D/A channels (12-bit), and 16 digital input lines and 16 digital output lines.

xPC Target supports this board with these driver blocks:

- “PCL-812PG Analog Input (A/D)” on page 11-27
- “PCL-812PG Analog Output (D/A)” on page 11-29
- “PCL-812PG Digital Input” on page 11-30
- “PCL-812PG Digital Output” on page 11-31

### Board Characteristics

|                                 |            |
|---------------------------------|------------|
| Board name                      | PCL-812PG  |
| Manufacturer                    | Advantech  |
| Bus type                        | ISA        |
| Access method                   | I/O mapped |
| Multiple block instance support | Yes        |
| Multiple board support          | Yes        |

### PCL-812PG Analog Input (A/D)

#### Scaling of Input to Output

| Hardware Input | Block Output Data Type | Scaling |
|----------------|------------------------|---------|
| volts          | Double                 | 1       |

#### Driver Block Parameters

**Channel vector** — Enter numbers between 1 and 16. For example, to use the first and second analog input (A/D) channels, enter

[1,2]

Number the channels beginning with 1 even if the board manufacturer starts numbering the channels with 0.

**Range vector** — Enter a range code for each of the channels in the channel vector. The range vector must be the same length as the channel vector. This board allows the range of each channel to be different.

The following table is a list of the ranges for this driver and the corresponding range codes.

| <b>Input Range (V)</b> | <b>Range Code</b> |
|------------------------|-------------------|
| -10 to +10             | -10               |
| -5 to +5               | -5                |
| -2.5 to +2.5           | -2.5              |
| -1.25 to +1.25         | -1.25             |
| -.625 to +.625         | -0.625            |
| 0 to 10                | 10                |
| 0 to +5                | 5                 |
| 0 to +2.5              | 2.5               |
| 0 to +1.25             | 1.25              |

For example, if the first channel is -10 to +10 volts, and the second channel is 0 to 5 volts, enter

[ -10,5]

The range settings must correspond to the DIP switch settings on the board.

**Sample time** — Base sample time or a multiple of the base sample time.

**Base address** — Enter the base address of the board. This entry must correspond to the DIP switch settings on the board. For example, if the base address is 300 (hexadecimal), enter

0x300

## PCL-812PG Analog Output (D/A)

### Scaling of Input to Output

| Hardware Output | Block Input Data Type | Scaling |
|-----------------|-----------------------|---------|
| volts           | Double                | 1       |

### Driver Block Parameter

**Channel vector** — Enter numbers between 1 and 2. This driver allows the selection of individual D/A channels in any order. The number of elements defines the number of D/A channels you use. For example, to use the first and second analog output (D/A) channels, enter

[ 1, 2]

Number the channels beginning with 1 even if the board manufacturer starts numbering the channels with 0.

**Range vector** — Enter a range code for each of the channels in the channel vector. The range vector must be the same length as the channel vector. This board allows the range of each channel to be different.

The following table is a list of the ranges for this driver and the corresponding range codes.

| Input Range  | Range Code |
|--------------|------------|
| -10 to +10 V | -10        |
| -5 to +5 V   | -5         |
| 0 to 10 V    | 10         |
| 0 to +5 V    | 5          |

For example, if the first channel is -10 to +10 volts, and the second channel is 0 to 5 volts, enter

[- 10,5]

The range settings must correspond to the DIP switch settings on the board.

**Sample time** — Base sample time or a multiple of the base sample time.

**Base address** — Enter the base address of the board. This entry must correspond to the DIP switch settings on the board. For example, if the base address is 300 (hexadecimal), enter

0x300

## PCL-812PG Digital Input

### Scaling of Input to Output

| Hardware Input | Block Output Data Type | Scaling                         |
|----------------|------------------------|---------------------------------|
| TTL            | Double                 | TTL low = 0.0<br>TTL high = 1.0 |

### Driver Block Parameters

**Channel vector** — Enter numbers between 1 and 16. This driver allows the selection of individual digital input lines in any order. The number of elements defines the number of digital lines used.

For example, to use the first eight digital inputs, enter

[1,2,3,4,5,6,7,8]

Number the lines beginning with 1 even if the board manufacturer starts numbering the lines with 0.

**Sample time** — Enter a base sample time or a multiple of the base sample time.

**Base address** — Enter the base address of the board. This entry must correspond to the DIP switch settings on the board. For example, if the base address is 300 (hexadecimal), enter

0x300

## PCL-812PG Digital Output

### Scaling of Input to Output

| Hardware Output | Block Input Data Type | Scaling                           |
|-----------------|-----------------------|-----------------------------------|
| TTL             | Double                | <0.5 = TTL low<br>≥0.5 = TTL high |

### Driver Block Parameters

**Channel vector** — Enter numbers between 1 and 16. This driver allows the selection of individual digital output lines in any order. The number of elements defines the number of digital lines used.

For example, to use the first eight digital outputs, enter

[1,2,3,4,5,6,7,8]

Number the lines beginning with 1 even if the board manufacturer starts numbering the lines with 0.

**Sample time** — Enter a base sample time or a multiple of the base sample time.

**Base address** — Enter the base address of the board. This entry must correspond to the DIP switch settings on the board. For example, if the base address is 300 (hexadecimal), enter

0x300

## PCL-818

The PCL-818 is an I/O board with 16 single or eight differential analog channels (12-bit) with a maximum sample rate of 100 KHz, two analog output D/A channels (12-bit), and 16 digital input lines and 16 digital output lines.

xPC Target supports this board with these driver blocks:

- “PCL-818 Analog Input (A/D)” on page 11-32
- “PCL-818 Analog Output (D/A)” on page 11-34
- “PCL-818 Digital Input” on page 11-35
- “PCL-818 Digital Output” on page 11-36

### Board Characteristics

|                                 |            |
|---------------------------------|------------|
| Board name                      | PCL-818    |
| Manufacturer                    | Advantech  |
| Bus type                        | ISA        |
| Access method                   | I/O mapped |
| Multiple block instance support | Yes        |
| Multiple board support          | Yes        |

## PCL-818 Analog Input (A/D)

### Scaling of Input to Output

| Hardware Input | Block Output Data Type | Scaling |
|----------------|------------------------|---------|
| volts          | Double                 | 1       |

### Driver Block Parameters

**Channel vector** — If you select 16 channels (**Input coupling** parameter set to Single-ended), enter numbers between 1 and 16. If you select differential (**Input coupling** parameter set to differential), enter numbers between 1



and 8. For example, to use the first and second analog output (A/D) channels, enter

[1,2]

Number the channels beginning with 1 even if the board manufacturer starts to number the channels with 0.

**Range vector** — Enter a range code for each of the channels in the channel vector. The range vector must be the same length as the channel vector. This board allows the range of each channel to be different.

The following table is a list of the ranges for this driver and the corresponding range codes.

| Input Range (V) | Range Code |
|-----------------|------------|
| -10 to +10      | -10        |
| -5 to +5        | -5         |
| -2.5 to +2.5    | -2.5       |
| -1.25 to +1.25  | -1.25      |
| -.625 to +.625  | -0.625     |
| 0 to 10         | 10         |
| 0 to +5         | 5          |
| 0 to +2.5       | 2.5        |
| 0 to +1.25      | 1.25       |

For example, if the first channel is -10 to +10 volts, and the second channel is 0 to 5 volts, enter

[-10,5]

The range settings must correspond to the DIP switch settings on the board.

**Input coupling** — From the list, select one from the following list of input modes:

- Single-ended channels (16 channels)
- differential channels (8 channels)

Your choice must correspond to the MUX switch setting on the board.

**Sample time** — Base sample time or a multiple of the base sample time.

**Base address** — Enter the base address of the board. This entry must correspond to the DIP switch settings on the board. For example, if the base address is 300 (hexadecimal), enter

0x300

## PCL-818 Analog Output (D/A)

### Scaling of Input to Output

| Hardware Output | Block Input Data Type | Scaling |
|-----------------|-----------------------|---------|
| volts           | Double                | 1       |

### Driver Block Parameter

**Channel vector** — Enter numbers between 1 and 2. This driver allows the selection of individual D/A channels in any order. The number of elements defines the number of D/A channels you use. For example, to use the first and second analog output (D/A) channels, enter

[1, 2]

Number the channels beginning with 1 even if the board manufacturer starts numbering the channels with 0.

**Range vector** — Enter a range code for each of the channels in the channel vector. The range vector must be the same length as the channel vector. This board allows the range of each channel to be different.

The following table is a list of the ranges for this driver and the corresponding range codes.

| <b>Input Range</b> | <b>Range Code</b> |
|--------------------|-------------------|
| -10 to +10V        | -10               |
| -5 to +5 V         | -5                |
| 0 to 10 V          | 10                |
| 0 to +5 V          | 5                 |

For example, if the first channel is -10 to +10 volts, and the second channel is 0 to 5 volts, enter

[ -10,5]

The range settings must correspond to the DIP switch settings on the board.

**Sample time** — Base sample time or a multiple of the base sample time.

**Base address** — Enter the base address of the board. This entry must correspond to the DIP switch settings on the board. For example, if the base address is 300 (hexadecimal), enter

0x300

## PCL-818 Digital Input

### Scaling of Input to Output

| <b>Hardware Input</b> | <b>Block Output Data Type</b> | <b>Scaling</b>                  |
|-----------------------|-------------------------------|---------------------------------|
| TTL                   | Double                        | TTL low = 0.0<br>TTL high = 1.0 |

### Driver Block Parameters

**Channel vector** — Enter numbers between 1 and 16. This driver allows the selection of individual digital input lines in any order. The number of elements defines the number of digital lines used.

For example, to use the first eight digital inputs, enter

[1,2,3,4,5,6,7,8]

Number the lines beginning with 1 even if the board manufacturer starts numbering the lines with 0.

**Sample time** — Enter a base sample time or a multiple of the base sample time.

**Base address** — Enter the base address of the board. This entry must correspond to the DIP switch settings on the board. For example, if the base address is 300 (hexadecimal), enter

0x300

## PCL-818 Digital Output

### Scaling of Input to Output

| Hardware Output | Block Input Data Type | Scaling                           |
|-----------------|-----------------------|-----------------------------------|
| TTL             | Double                | <0.5 = TTL low<br>≥0.5 = TTL high |

### Driver Block Parameters

**Channel vector** — Enter numbers between 1 and 16. This driver allows the selection of individual digital output lines in any order. The number of elements defines the number of digital lines used.

For example, to use the first eight digital outputs, enter

[1,2,3,4,5,6,7,8]

Number the lines beginning with 1 even if the board manufacturer starts numbering the lines with 0.

**Sample time** — Enter a base sample time or a multiple of the base sample time.

**Base address** — Enter the base address of the board. This entry must correspond to the DIP switch settings on the board. For example, if the base address is 300 (hexadecimal), enter

0x300

## PCL-818H

The PCL-818H is an I/O board with 16 single or eight differential analog channels (12-bit) with a maximum sample rate of 100 KHz, one analog output D/A channel (12-bit), and 16 digital input lines and 16 digital output lines.

xPC Target supports this board with these driver blocks:

- “PCL-818H Analog Input (A/D)” on page 11-38
- “PCL-818H Analog Output (D/A)” on page 11-40
- “PCL-818H Digital Input” on page 11-41
- “PCL-818H Digital Output” on page 11-42

### Board Characteristics

|                                 |            |
|---------------------------------|------------|
| Board name                      | PCL-818H   |
| Manufacturer                    | Advantech  |
| Bus type                        | ISA        |
| Access method                   | I/O mapped |
| Multiple block instance support | Yes        |
| Multiple board support          | Yes        |

### PCL-818H Analog Input (A/D)

#### Scaling of Input to Output

| Hardware Input | Block Output Data Type | Scaling |
|----------------|------------------------|---------|
| volts          | Double                 | 1       |

#### Driver Block Parameters

**Channel vector** — If you select 16 channels (**Input coupling** parameter set to Single-ended), enter numbers between 1 and 16. If you select differential (**Input coupling** parameter set to differential), enter numbers between 1

and 8. For example, to use the first and second analog output (A/D) channels, enter

[1,2]

Number the channels beginning with 1 even if the board manufacturer starts to number the channels with 0.

**Range vector** — Enter a range code for each of the channels in the channel vector. The range vector must be the same length as the channel vector. This board allows the range of each channel to be different.

The following table is a list of the ranges for this driver and the corresponding range codes.

| Input Range (V) | Range Code |
|-----------------|------------|
| -10 to +10      | -10        |
| -5 to +5        | -5         |
| -2.5 to +2.5    | -2.5       |
| -1.25 to +1.25  | -1.25      |
| -.625 to +.625  | -0.625     |
| 0 to 10         | 10         |
| 0 to +5         | 5          |
| 0 to +2.5       | 2.5        |
| 0 to +1.25      | 1.25       |

For example, if the first channel is -10 to +10 volts, and the second channel is 0 to 5 volts, enter

[-10,5]

The range settings must correspond to the DIP switch settings on the board.

**Input coupling** — From the list, select one from the following list of input modes:

- Single-ended channels (16 channels)
- differential channels (8 channels)

This choice must correspond to the MUX switch setting on the board.

**Sample time** — Base sample time or a multiple of the base sample time.

**Base address** — Enter the base address of the board. This entry must correspond to the DIP switch settings on the board. For example, if the base address is 300 (hexadecimal), enter

0x300

## PCL-818H Analog Output (D/A)

### Scaling of Input to Output

| Hardware Output | Block Input Data Type | Scaling |
|-----------------|-----------------------|---------|
| volts           | Double                | 1       |

### Driver Block Parameter

**Range** — From the list, choose either 0-10V or 0-5V.

The range settings must correspond to the DIP switch settings on the board.

**Sample time** — Base sample time or a multiple of the base sample time.

**Base address** — Enter the base address of the board. This entry must correspond to the DIP switch settings on the board. For example, if the base address is 300 (hexadecimal), enter

0x300



## PCL-818H Digital Input

### Scaling of Input to Output

| Hardware Input | Block Output Data Type | Scaling                         |
|----------------|------------------------|---------------------------------|
| TTL            | Double                 | TTL low = 0.0<br>TTL high = 1.0 |

### Driver Block Parameters

**Channel vector** — Enter numbers between 1 and 16. This driver allows the selection of individual digital input lines in any order. The number of elements defines the number of digital lines you use.

For example, to use the first eight digital inputs, enter

[1,2,3,4,5,6,7,8]

Number the lines beginning with 1 even if the board manufacturer starts numbering the lines with 0.

**Sample time** — Enter a base sample time or a multiple of the base sample time.

**Base address** — Enter the base address of the board. This entry must correspond to the DIP switch settings on the board. For example, if the base address is 300 (hexadecimal), enter

0x300

## PCL-818H Digital Output

### Scaling of Input to Output

| Hardware Output | Block Input Data Type | Scaling                           |
|-----------------|-----------------------|-----------------------------------|
| TTL             | Double                | <0.5 = TTL low<br>≥0.5 = TTL high |

### Driver Block Parameters

**Channel vector** — Enter numbers between 1 and 16. This driver allows the selection of individual digital output lines in any order. The number of elements defines the number of digital lines you use.

For example, to use the first eight digital outputs, enter

[1,2,3,4,5,6,7,8]

Number the lines beginning with 1 even if the board manufacturer starts numbering the lines with 0.

**Sample time** — Enter a base sample time or a multiple of the base sample time.

**Base address** — Enter the base address of the board. This entry must correspond to the DIP switch settings on the board. For example, if the base address is 300 (hexadecimal), enter

0x300

## PCL-818HD

The PCL-818HD is an I/O board with 16 single or eight differential analog channels (12-bit) with a maximum sample rate of 100 KHz, one analog output D/A channels (12-bit), and 16 digital input lines and 16 digital output lines.

xPC Target supports this board with these driver blocks:

- “PCL-818HD Analog Input (A/D)” on page 11-43
- “PCL-818HD Analog Output (D/A)” on page 11-45
- “PCL-818HD Digital Input” on page 11-46
- “PCL-818HD Digital Output” on page 11-47

### Board Characteristics

|                                 |            |
|---------------------------------|------------|
| Board name                      | PCL-818HD  |
| Manufacturer                    | Advantech  |
| Bus type                        | ISA        |
| Access method                   | I/O mapped |
| Multiple block instance support | Yes        |
| Multiple board support          | Yes        |

### PCL-818HD Analog Input (A/D)

#### Scaling of Input to Output

| Hardware Input | Block Output Data Type | Scaling |
|----------------|------------------------|---------|
| volts          | Double                 | 1       |

#### Driver Block Parameters

**Channel vector** — If you select 16 channels (**Input coupling** parameter set to Single-ended), enter numbers between 1 and 16. If you select differential (**Input coupling** parameter set to differential), enter numbers between 1

and 8. For example, to use the first and second analog output (A/D) channels, enter

[1,2]

Number the channels beginning with 1 even if the board manufacturer starts to number the channels with 0.

**Range vector** — Enter a range code for each of the channels in the channel vector. The range vector must be the same length as the channel vector. This board allows the range of each channel to be different.

The following table is a list of the ranges for this driver and the corresponding range codes.

| Input Range (V) | Range Code |
|-----------------|------------|
| -10 to +10      | -10        |
| -5 to +5        | -5         |
| -2.5 to +2.5    | -2.5       |
| -1.25 to +1.25  | -1.25      |
| -.625 to +.625  | -0.625     |
| 0 to 10         | 10         |
| 0 to +5         | 5          |
| 0 to +2.5       | 2.5        |
| 0 to +1.25      | 1.25       |

For example, if the first channel is -10 to +10 volts, and the second channel is 0 to 5 volts, enter

[-10,5]

The range settings must correspond to the DIP switch settings on the board.

**Input coupling** — From the list, select one from the following list of input modes:

- Single-ended channels (16 channels)
- differential channels (8 channels)

Your choice must correspond to the MUX switch setting on the board.

**Sample time** — Base sample time or a multiple of the base sample time.

**Base address** — Enter the base address of the board. This entry must correspond to the DIP switch settings on the board. For example, if the base address is 300 (hexadecimal), enter

0x300

## PCL-818HD Analog Output (D/A)

### Scaling of Input to Output

| Hardware Output | Block Input Data Type | Scaling |
|-----------------|-----------------------|---------|
| volts           | Double                | 1       |

### Driver Block Parameter

**Range** — From the list, choose either 0-10V or 0-5V.

The range settings must correspond to the DIP switch settings on the board.

**Sample time** — Base sample time or a multiple of the base sample time.

**Base address** — Enter the base address of the board. This entry must correspond to the DIP switch settings on the board. For example, if the base address is 300 (hexadecimal), enter

0x300

## PCL-818HD Digital Input

### Scaling of Input to Output

| Hardware Input | Block Output Data Type | Scaling                         |
|----------------|------------------------|---------------------------------|
| TTL            | Double                 | TTL low = 0.0<br>TTL high = 1.0 |

### Driver Block Parameters

**Channel vector** — Enter numbers between 1 and 16. This driver allows the selection of individual digital input lines in any order. The number of elements defines the number of digital lines you use.

For example, to use the first eight digital inputs, enter

[1,2,3,4,5,6,7,8]

Number the lines beginning with 1 even if the board manufacturer starts numbering the lines with 0.

**Sample time** — Enter a base sample time or a multiple of the base sample time.

**Base address** — Enter the base address of the board. This entry must correspond to the DIP switch settings on the board. For example, if the base address is 300 (hexadecimal), enter

0x300

## PCL-818HD Digital Output

### Scaling of Input to Output

| Hardware Output | Block Input Data Type | Scaling                           |
|-----------------|-----------------------|-----------------------------------|
| TTL             | Double                | <0.5 = TTL low<br>≥0.5 = TTL high |

### Driver Block Parameters

**Channel vector** — Enter numbers between 1 and 16. This driver allows the selection of individual digital output lines in any order. The number of elements defines the number of digital lines you use.

For example, to use the first eight digital outputs, enter

```
[1,2,3,4,5,6,7,8]
```

Number the lines beginning with 1 even if the board manufacturer starts numbering the lines with 0.

**Sample time** — Enter a base sample time or a multiple of the base sample time.

**Base address** — Enter the base address of the board. This entry must correspond to the DIP switch settings on the board. For example, if the base address is 300 (hexadecimal), enter

```
0x300
```

## PCL-818HG

The PCL-818 is an I/O board with 16 single or eight differential analog input (A/D) channels (12-bit) with a maximum sample rate of 100 KHz, one analog output (D/A) channel (12-bit), and 16 digital input lines and 16 digital output lines.

xPC Target supports this board with these driver blocks:

- “PCL-818HG Analog Input (A/D)” on page 11-48
- “PCL-818HG Analog Output (D/A)” on page 11-50
- “PCL-818HG Digital Input” on page 11-51
- “PCL-818HG Digital Output” on page 11-52

### Board Characteristics

|                                 |            |
|---------------------------------|------------|
| Board name                      | PCL-818HG  |
| Manufacturer                    | Advantech  |
| Bus type                        | ISA        |
| Access method                   | I/O mapped |
| Multiple block instance support | Yes        |
| Multiple board support          | Yes        |

### PCL-818HG Analog Input (A/D)

#### Scaling of Input to Output

| Hardware Input | Block Output Data Type | Scaling |
|----------------|------------------------|---------|
| volts          | Double                 | 1       |



### Driver Block Parameters

**Channel vector** — If you select 16 channels (**Input coupling** parameter set to Single-ended), enter numbers between 1 and 16. If you select differential (**Input coupling** parameter set to differential), enter numbers between 1 and 8. For example, to use the first and second analog output (A/D) channels, enter

[ 1,2]

Number the channels beginning with 1 even if the board manufacturer starts to number the channels with 0.

**Range vector** — Enter a range code for each of the channels in the channel vector. The range vector must be the same length as the channel vector. This board allows the range of each channel to be different.

The following table is a list of the ranges for this driver and the corresponding range codes.

| Input Range (V) | Range Code |
|-----------------|------------|
| -10 to +10      | -10        |
| -5 to +5        | -5         |
| -2.5 to +2.5    | -2.5       |
| -1.25 to +1.25  | -1.25      |
| -.625 to +.625  | -0.625     |
| 0 to 10         | 10         |
| 0 to +1         | 1          |
| 0 to +0.1       | 0.1        |
| 0 to +0.01      | 0.01       |

For example, if the first channel is -10 to +10 volts, and the second channel is 0 to 5 volts, enter

[ -10,5]

The range settings must correspond to the DIP switch settings on the board.

**Input coupling** — From the list, select one from the following list of input modes:

- Single-ended channels (16 channels)
- differential channels (8 channels)

Your choice must correspond to the MUX switch setting on the board.

**Sample time** — Base sample time or a multiple of the base sample time.

**Base address** — Enter the base address of the board. This entry must correspond to the DIP switch settings on the board. For example, if the base address is 300 (hexadecimal), enter

0x300

## PCL-818HG Analog Output (D/A)

### Scaling of Input to Output

| Hardware Output | Block Input Data Type | Scaling |
|-----------------|-----------------------|---------|
| volts           | Double                | 1       |

### Driver Block Parameter

**Range** — From the list, choose either 0-10V or 0-5V.

The range settings must correspond to the DIP switch settings on the board.

**Sample time** — Base sample time or a multiple of the base sample time.

**Base address** — Enter the base address of the board. This entry must correspond to the DIP switch settings on the board. For example, if the base address is 300 (hexadecimal), enter

0x300

## PCL-818HG Digital Input

### Scaling of Input to Output

| Hardware Input | Block Output Data Type | Scaling                         |
|----------------|------------------------|---------------------------------|
| TTL            | Double                 | TTL low = 0.0<br>TTL high = 1.0 |

### Driver Block Parameters

**Channel vector** — Enter numbers between 1 and 16. This driver allows the selection of individual digital input lines in any order. The number of elements defines the number of digital lines you use.

For example, to use the first eight digital inputs, enter

[1,2,3,4,5,6,7,8]

Number the lines beginning with 1 even if the board manufacturer starts numbering the lines with 0.

**Sample time** — Enter a base sample time or a multiple of the base sample time.

**Base address** — Enter the base address of the board. This entry must correspond to the DIP switch settings on the board. For example, if the base address is 300 (hexadecimal), enter

0x300

## PCL-818HG Digital Output

### Scaling of Input to Output

| Hardware Output | Block Input Data Type | Scaling                           |
|-----------------|-----------------------|-----------------------------------|
| TTL             | Double                | <0.5 = TTL low<br>≥0.5 = TTL high |

### Driver Block Parameters

**Channel vector** — Enter numbers between 1 and 16. This driver allows the selection of individual digital output lines in any order. The number of elements defines the number of digital lines you use.

For example, to use the first eight digital outputs, enter

[1,2,3,4,5,6,7,8]

Number the lines beginning with 1 even if the board manufacturer starts numbering the lines with 0.

**Sample time** — Enter a base sample time or a multiple of the base sample time.

**Base address** — Enter the base address of the board. This entry must correspond to the DIP switch settings on the board. For example, if the base address is 300 (hexadecimal), enter

0x300

## PCL-818L

The PCL-818L is an I/O board with 16 single or eight differential analog input (A/D) channels (12-bit) with a maximum sample rate of 40 KHz, one analog output (D/A) channels (12-bit), 16 digital input lines, and 16 digital output lines.

xPC Target supports this board with these driver blocks:

- “PCL-818L Analog Input (A/D)” on page 11-53
- “PCL-818L Analog Output (D/A)” on page 11-55
- “PCL-818L Digital Input” on page 11-56
- “PCL-818L Digital Output” on page 11-57

### Board Characteristics

|                                 |            |
|---------------------------------|------------|
| Board name                      | PCL-818    |
| Manufacturer                    | Advantech  |
| Bus type                        | ISA        |
| Access method                   | I/O mapped |
| Multiple block instance support | Yes        |
| Multiple board support          | Yes        |

### PCL-818L Analog Input (A/D)

#### Scaling of Input to Output

| Hardware Input | Block Output Data Type | Scaling |
|----------------|------------------------|---------|
| volts          | Double                 | 1       |

## Driver Block Parameters

**Channel vector** — If you select 16 channels (**Input coupling** parameter set to Single-ended), enter numbers between 1 and 16. If you select differential (**Input coupling** parameter set to differential), enter numbers between 1 and 8. For example, to use the first and second analog output (A/D) channels, enter

[1,2]

Number the channels beginning with 1 even if the board manufacturer starts to number the channels with 0.

**Range vector** — Enter a range code for each of the channels in the channel vector. The range vector must be the same length as the channel vector. This board allows the range of each channel to be different.

The following table is a list of the ranges for this driver and the corresponding range codes.

| Input Range (V) | Range Code |
|-----------------|------------|
| -10 to +10      | -10        |
| -5 to +5        | -5         |
| -2.5 to +2.5    | -2.5       |
| -1.25 to +1.25  | -1.25      |
| -.625 to +.625  | -0.625     |

For example, if the first channel is -10 to +10 volts, and the second channel is -5 to 5 volts, enter

[-10, -5]

The range settings must correspond to the DIP switch settings on the board.

**Input coupling** — From the list, select one from the following list of input modes:

- Single-ended channels (16 channels)
- differential channels (8 channels)

Your choice must correspond to the MUX switch setting on the board.

**Sample time** — Base sample time or a multiple of the base sample time.

**Base address** — Enter the base address of the board. This entry must correspond to the DIP switch settings on the board. For example, if the base address is 300 (hexadecimal), enter

0x300

## PCI-818L Analog Output (D/A)

### Scaling of Input to Output

| Hardware Output | Block Input Data Type | Scaling |
|-----------------|-----------------------|---------|
| volts           | Double                | 1       |

### Driver Block Parameter

**Range** — From the list, choose either 0-10V or 0-5V.

The range setting must correspond to the DIP switch settings on the board.

**Sample time** — Base sample time or a multiple of the base sample time.

**Base address** — Enter the base address of the board. This entry must correspond to the DIP switch settings on the board. For example, if the base address is 300 (hexadecimal), enter

0x300

## PCL-818L Digital Input

### Scaling of Input to Output

| Hardware Input | Block Output Data Type | Scaling                         |
|----------------|------------------------|---------------------------------|
| TTL            | Double                 | TTL low = 0.0<br>TTL high = 1.0 |

### Driver Block Parameters

**Channel vector** — Enter channels between 1 and 16. This driver allows the selection of individual digital input lines in any order. The number of elements defines the number of digital lines you use.

For example, to use the first eight digital inputs, enter

[1,2,3,4,5,6,7,8]

Number the lines beginning with 1 even if the board manufacturer starts numbering the lines with 0.

**Sample time** — Enter a base sample time or a multiple of the base sample time.

**Base address** — Enter the base address of the board. This entry must correspond to the DIP switch settings on the board. For example, if the base address is 300 (hexadecimal), enter

0x300



## PCL-818L Digital Output

### Scaling of Input to Output

| Hardware Output | Block Input Data Type | Scaling                           |
|-----------------|-----------------------|-----------------------------------|
| TTL             | Double                | <0.5 = TTL low<br>≥0.5 = TTL high |

### Driver Block Parameters

**Channel vector** — Enter channels between 1 and 16. This driver allows the selection of individual digital output lines in any order. The number of elements defines the number of digital lines you use.

For example, to use the first eight digital outputs, enter

```
[1,2,3,4,5,6,7,8]
```

Number the lines beginning with 1 even if the board manufacturer starts numbering the lines with 0.

**Sample time** — Enter a base sample time or a multiple of the base sample time.

**Base address** — Enter the base address of the board. This entry must correspond to the DIP switch settings on the board. For example, if the base address is 300 (hexadecimal), enter

```
0x300
```



# Analogic

---

This chapter describes the Analogic I/O boards supported by xPC Target  
(<http://www.analogic.com>).

AIM12 (p. 12-2)

I/O board with 16 single or 8 differential analog input  
(A/D) channels (12-bit)

AIM16 (p. 12-6)

I/O board with 16 single or 8 differential analog input  
(A/D) channels (16-bit)

## AIM12

This board comes in three configurations from the factory. The configurations are the AIM12-1/104, the AIM16-1/104, and the AIM16-2/104. The AIM16-1/104 and the AIM16-2/104 differ only in the time needed to acquire each sample. The AIM12-1/104 acquires 4 fewer bits, but since the 12 bits are placed in the high 12 bits of the result word, the internal scaling factors are identical to those used with the AIM16. The output of the AIM12 changes in larger steps. Gain settings for the AIM12 are also different than for the AIM16.

When acquiring samples from multiple channels, the board is driven in its burst mode when the highest clock rate available for the board is used. The AIM12-1/104 can acquire all 16 channels in 160 microseconds.

The AIM12 hardware can acquire from 1 to 16 (single ended) channels at each sample time. These channels must be in a contiguous group, but can start with any channel number and end with any channel number that is greater than or equal to the start channel number. A single channel is acquired by setting both first channel and last channel to the same value.

The choice of unipolar or bipolar conversion range is made by placing jumpers in accordance with the hardware manual. The driver is able to read the hardware configuration and adjusts the integer to float conversion as necessary.

xPC Target supports this board with these driver blocks:

- “AIM12 Analog Input (A/D)” on page 12-3
- “AIM12 Digital Input” on page 12-4
- “AIM12 Digital Output” on page 12-5

### Board Characteristics

|                                 |            |
|---------------------------------|------------|
| Board name                      | AIM12      |
| Manufacturer                    | Analogic   |
| Bus type                        | PC/104     |
| Access method                   | I/O mapped |
| Multiple block instance support | No         |
| Multiple board support          | Yes        |

## AIM12 Analog Input (A/D)

### Scaling Input to Output

| Hardware Input | Block Input Data Type | Scaling |
|----------------|-----------------------|---------|
| volts          | Double                | 1       |

### Driver Block Parameters

**First channel** — In Single-ended (16 channels) input mode, enter a number between 1 and 16 to indicate the first channel to be acquired. In Differential (8 channels) input mode, enter a a number between 1 and 8.

**Last channel** — This is the last channel to acquire. The number must be greater than or equal to the first channel. In Single-ended (16 channels) input mode, the number must be less than or equal to 16. In Differential (8 channels) input mode, the number must be less than or equal to 8.

**Input coupling** — From the list, select one from the following list of input modes:

- Single-ended channels (16 channels)
- Differential channels (8 channels)

Check the hardware manual of the board for wiring configurations.

**Gain vector** — Enter a vector of gain values with one entry for each channel in the range first channel to last channel. Allowable gain settings for the AIM12 are 1, 10, and 100. If you enter a scalar for gain, this gain value is used for all channels.

**Sample time** — Enter a base sample time or a multiple of the base sample time.

**Base address** — Enter the base address of the board in hexadecimal (such as 0x300) as determined by the hardware jumpers on the board.

## AIM12 Digital Input

### Scaling Input to Output

| Hardware Input | Block Output Data Type | Scaling                         |
|----------------|------------------------|---------------------------------|
| TTL            | Double                 | TTL low = 0.0<br>TTL high = 1.0 |

### Driver Block Parameters

**Channel vector** — Enter numbers between 1 and 8 to select the digital input lines to be read. This driver allows the selection of individual digital input lines in any order. The number of elements defines the number of digital lines used. For example, to use all of the digital inputs enter

[1, 2, 3, 4, 5, 6, 7, 8]

Number the channels beginning with 1 even though the board manufacturer numbers them beginning with 0.

**Channel group** — Choose Lower 8 bits to connect to channels 1 through 8 or Upper 8 bits to connect to channels 9 through 16.

**Sample time** — Enter the base sample time or a multiple of the base sample time.

**Base address** — Enter the base address of the board in hexadecimal (such as 0x300) as determined by the hardware jumpers on the board.

## AIM12 Digital Output

### Scaling Input to Output

| Hardware Output | Block Input Data Type | Scaling                             |
|-----------------|-----------------------|-------------------------------------|
| TTL             | Double                | < 0.5 = TTL low<br>≥ 0.5 = TTL high |

### Driver Block Parameters

**Channel vector** — Enter numbers between 1 and 8 to select the digital input lines to be read. This driver allows the selection of individual digital input lines in any order. The number of elements defines the number of digital lines used. For example, to use all of the digital inputs enter

[1, 2, 3, 4, 5, 6, 7, 8]

Number the channels beginning with 1 even though the board manufacturer numbers them beginning with 0.

**Channel group** — Choose Lower 8 bits to connect to channels 1 through 8 or Upper 8 bits to connect to channels 9 through 16.

**Sample time** — Enter the base sample time or a multiple of the base sample time.

**Base address** — Enter the base address of the board in hexadecimal (such as 0x300) as determined by the hardware jumpers on the board.

## AIM16

This board comes in three configurations from the factory. The configurations are the AIM12-1/104, the AIM16-1/104 and the AIM16-2/104. The AIM16-1/104 and the AIM16-2/104 differ only in the time needed to acquire each sample. The AIM12-1/104 acquires 4 fewer bits, but since the 12 bits are placed in the high 12 bits of the result word, the internal scaling factors are identical to those used with the AIM16. The output of the AIM12 changes in larger steps. Gain settings for the AIM12 are also different than for the AIM16.

When acquiring samples from multiple channels, the board is driven in its burst mode when the highest clock rate available for the board is used. The AIM16-1/104 can acquire all 16 channels in 160 microseconds while the AIM16-2/104 completes the same acquisition in 80 microseconds.

The AIM16 hardware can acquire from 1 to 16 (single ended) channels at each sample time. These channels must be in a contiguous group, but can start with any channel number and end with any channel number that is greater than or equal to the start channel number. A single channel is acquired by setting both first channel and last channel to the same value.

The choice of unipolar or bipolar conversion range is made by placing jumpers in accordance with the hardware manual. The driver is able to read the hardware configuration and adjusts the integer to float conversion as necessary.

xPC Target supports this board with these driver blocks:

- “AIM16 Analog Input (A/D)” on page 12-7
- “AIM16 Digital Input” on page 12-8
- “AIM16 Digital Output” on page 12-9

### Board Characteristics

|               |            |
|---------------|------------|
| Board name    | AIM16      |
| Manufacturer  | Analogic   |
| Bus type      | PC/104     |
| Access method | I/O mapped |



|                                 |     |
|---------------------------------|-----|
| Multiple block instance support | No  |
| Multiple board support          | Yes |

## AIM16 Analog Input (A/D)

### Scaling Input to Output

| Hardware Input | Block Input Data Type | Scaling |
|----------------|-----------------------|---------|
| volts          | Double                | 1       |

### Driver Block Parameters

**First channel** — In Single-ended (16 channels) input mode, enter a number between 1 and 16 to indicate the first channel to be acquired. In Differential (8 channels) input mode, enter a a number between 1 and 8.

**Last channel** — This is the last channel to acquire. The number must be greater than or equal to the first channel. In Single-ended (16 channels) input mode, the number must be less than or equal to 16. In Differential (8 channels) input mode, the number must be less than or equal to 8.

**Input coupling** — From the list, select one from the following list of input modes:

- Single-ended channels (16 channels)
- Differential channels (8 channels)

Check the hardware manual of the board for wiring configurations.

**Gain vector** — Enter a vector of gain values with one entry for each channel in the range first channel to last channel. Allowable gain settings for the AIM16 are 1, 2, 4, and 8. If you enter a scalar for gain, this gain value is used for all channels.

**Sample time** — Enter a base sample time or a multiple of the base sample time.

**Base address** — Enter the base address of the board in hexadecimal (such as 0x300) as determined by the hardware jumpers on the board.

## AIM16 Digital Input

### Scaling Input to Output

| Hardware Input | Block Output Data Type | Scaling                         |
|----------------|------------------------|---------------------------------|
| TTL            | Double                 | TTL low = 0.0<br>TTL high = 1.0 |

### Driver Block Parameters

**Channel vector** — Enter numbers between 1 and 8 to select the digital input lines to be read. This driver allows the selection of individual digital input lines in any order. The number of elements defines the number of digital lines used. For example, to use all of the digital inputs enter

[1, 2, 3, 4, 5, 6, 7, 8]

Number the channels beginning with 1 even though the board manufacturer numbers them beginning with 0.

**Channel group** — Choose Lower 8 bits to connect to channels 1 through 8 or Upper 8 bits to connect to channels 9 through 16.

**Sample time** — Enter the base sample time or a multiple of the base sample time.

**Base address** — Enter the base address of the board in hexadecimal (such as 0x300) as determined by the hardware jumpers on the board.

## AIM16 Digital Output

### Scaling Input to Output

| Hardware Output | Block Input Data Type | Scaling                             |
|-----------------|-----------------------|-------------------------------------|
| TTL             | Double                | < 0.5 = TTL low<br>≥ 0.5 = TTL high |

### Driver Block Parameters

**Channel vector** — Enter numbers between 1 and 8 to select the digital input lines to be read. This driver allows the selection of individual digital input lines in any order. The number of elements defines the number of digital lines used. For example, to use all of the digital inputs enter

[1, 2, 3, 4, 5, 6, 7, 8]

Number the channels beginning with 1 even though the board manufacturer numbers them beginning with 0.

**Channel group** — Choose Lower 8 bits to connect to channels 1 through 8 or Upper 8 bits to connect to channels 9 through 16.

**Sample time** — Enter the base sample time or a multiple of the base sample time.

**Base address** — Enter the base address of the board in hexadecimal (such as 0x300) as determined by the hardware jumpers on the board.



# BittWare

---

This chapter describes the BittWare boards supported by xPC Target (<http://www.bittware.com>).

Audio-PMC+ (p. 13-2)

Professional audio board with 8 channels of audio input and output.

## Audio-PMC+

The Audio-PMC+ board is an audio board with 8 I/O channels.

xPC Target supports this board with these driver blocks:

- “Audio-PMC+ Analog Input” on page 13-3
- “Audio-PMC+ Analog Output” on page 13-5

Block parameters for the input and output blocks appear the same.

### Board Characteristics

|                                 |               |
|---------------------------------|---------------|
| Board name                      | Audio-PMC+    |
| Manufacturer                    | BittWare      |
| Bus type                        | PCI           |
| Access method                   | Memory mapped |
| Multiple block instance support | No            |
| Multiple board support          | No            |

### Features

- Input and output are in the form of the Signal Processing Blockset frame signal type when the frame is larger than a single sample.
- The analog input block outputs a double or 32 bit integer frame of data.
- The Audio-PMC+ board performs acquisition simultaneously for all the selected channels in a model.
- The analog output block is dynamically typed. The integer or double data type is taken from the connection instead of a block parameter.

### Hardware Installation Notes

The Audio-PMC+ daughter board might come from BittWare with jumpers installed to boot from an onboard ROM. You must remove these jumpers, as follows:

- 1 With the Audio-PMC+ off the carrier board, look for 6 pairs of pins along one edge. For proper operation with xPC Target, none of the pairs should be jumpered.
- 2 If there are any jumpers present, remove and then reinstall the jumpers with only one pin connected. Leave the other side of the jumper hanging. Leaving the jumpers like this will provide you with the jumpers if you want to use the board in ROM bootable mode at some future time.

## Audio-PMC+ Analog Input

### Driver Block Parameters

**Channel Vector** — This is a vector of channels. Specifies the input channels that the block works on. For example, to use the first, third, and fifth analog input channels, enter

```
[1,3,5]
```

**Output Format** — Specify the format that the data takes. The choices are

- A normalized double in the range from -1.0 to 1.0
- An unscaled integer

The unscaled integer format is usable with blocks that can accept fixed point data. This format contains the data in the lower 24 bits of a 32 bit integer with sign extension in the upper 8 bits.

This parameter is only settable for the analog input block. The analog output block determines the data type from the connection and sets itself appropriately.

**Frame Size, Sample Rate, and Sampletime** — These three parameters are not independent but are related by:

$$FrameSize = Sampletime \times SampleRate$$

After you specify two of the parameters, the equation determines the third parameter.

For example, if you set **Frame Size** to 32 and **Sample Rate** to 40000, specify **Sampletime** as -1. It is computed internally to 0.0008 seconds. This example model will execute every 0.0008 seconds, which is every 32 samples at 40 KHz.

Conversely, you can also specify that you want to execute every 1.0 ms with a **Frame Size** of 64 samples. Specify **Sample Rate** as -1. It is computed to be 64000 Hz.

The implementation of **Sample Rate** on the Audio-PMC+ might cause the rate on your board to be inexact. Audio-PMC+ derives the sample rate using the PWM0 output from the first 21065L SHARC DSP chip. The base clock that effects this output is the 60 MHz CPU clock for sample rates between 100 KHz and 20 KHz and a prescaled 30 MHz CPU clock (half the 60 MHz CPU clock) for sample rates between 8 KHz and 20 KHz.

The sample rate is implemented internally by specifying the total number of counts per sample interval. For example, the number of counts for a sample rate of 44.1 KHz is calculated as

$$60 \times 10^6 / 44.1 \times 10^3 = 1360.544217$$

This value is rounded down to 1360. To calculate the actual clock sample rate, divide 60 MHz by the number of counts

$$60 \times 10^6 / 1360 = 44117.647$$

The result indicates that the sample rate is off by 0.04%. This calculation assumes that the CPU clock is exactly 60 MHz.

Since you can build a model with just input or just output, the three rate parameters are included in both block parameter dialogs. You must set them to equal values if you have a model that has both. If they are not equal, you will get an error when you try to build the model.

The practical limit on **Sample Rate** is

$$8000 \leq \text{SampleRate} \leq 100000$$

Below 8 KHz, the output digital filter does not seem to work, although the converter continues to work there.

**Frame Size** values can be between 1 and 256. If the specified or computed frame size exceeds 256, the driver will return an error during initialization.



**PCI Slot (-1:autosearch)** — If only one board of this type is physically present in the target PC, enter

```
-1
```

to automatically locate the board.

If two or more boards of this type are physically present in the target PC, enter the bus number and the PCI slot number of the board associated with this driver block. Use the format [BusNumber, SlotNumber]. To determine the bus number and the PCI slot number, type

```
getxpcpci
```

---

**Note** The use of multiple boards, at the same time and in the same model, is unsupported.

---

## Audio-PMC+ Analog Output

### Driver Block Parameters

**Channel Vector** — This is a vector of channels. Specifies the output channels that the block works on. For example, to use the first, third, and fifth analog output channels, enter

```
[1,3,5]
```

**Frame Size, Sample Rate, and Sampletime** — These three parameters are not independent but are related by:

$$FrameSize = Sampletime \times SampleRate$$

After you specify two of the parameters, the equation determines the third parameter.

For example, if you set **Frame Size** to 32 and **Sample Rate** to 40000, specify **Sampletime** as -1. It is computed internally to 0.0008 seconds. This example model will execute every 0.0008 seconds, which is every 32 samples at 40 KHz.

Conversely, you can also specify that you want to execute every 1.0 ms with a **Frame Size** of 64 samples. Specify **Sample Rate** as -1. It is computed to be 64000 Hz.

The implementation of **Sample Rate** on the Audio-PMC+ might cause the rate on your board to be inexact. Audio-PMC+ derives the sample rate using the PWM0 output from the first 21065L SHARC DSP chip. The base clock that effects this output is the 60 MHz CPU clock for sample rates between 100 KHz and 20 KHz and a prescaled 30 MHz CPU clock (half the 60 MHz CPU clock) for sample rates between 8 KHz and 20 KHz.

The sample rate is implemented internally by specifying the total number of counts per sample interval. For example, the number of counts for a sample rate of 44.1 KHz is calculated as

$$60 \times 10^6 / 44.1 \times 10^3 = 1360.544217$$

This value is rounded down to 1360. To calculate the actual clock sample rate, divide 60 MHz by the number of counts

$$60 \times 10^6 / 1360 = 44117.647$$

The result indicates that the sample rate is off by 0.04%. This calculation assumes that the CPU clock is exactly 60 MHz.

Since you can build a model with just input or just output, the three rate parameters are included in both block parameter dialogs. You must set them to equal values if you have a model that has both. If they are not equal, you will get an error when you try to build the model.

The practical limit on **Sample Rate** is

$$8000 \leq \text{SampleRate} \leq 100000$$

Below 8 KHz, the output digital filter does not seem to work, although the converter continues to work there.

**Frame Size** values can be between 1 and 256. If the specified or computed frame size exceeds 256, the driver will return an error during initialization.

**PCI Slot (-1:autosearch)** — If only one board of this type is physically present in the target PC, enter

-1

to automatically locate the board.

If two or more boards of this type are physically present in the target PC, enter the bus number and the PCI slot number of the board associated with this driver block. Use the format [BusNumber, SlotNumber]. To determine the bus number and the PCI slot number, type

```
getxpcpci
```

---

**Note** The use of multiple boards, at the same time and in the same model, is unsupported.

---

### Frame Size, Sample Rate, and Sampletime Notes

Experimentally, with all 8 input and all 8 output channels in use, the Audio-PMC+ can run with sample rates below the following frequencies as a function of Frame Size:

| Frame Size | Maximum Sample Rate |
|------------|---------------------|
| 1          | 15 KHz              |
| 2          | 30 KHz              |
| 3          | 40 KHz              |
| 4          | 45 KHz              |
| 8          | 70 KHz              |
| 16         | 80 KHz              |
| 32         | 80 KHz              |
| 64         | 100KHz              |
| 128        | 100KHz              |
| 256        | 100KHz              |

If fewer than all 8 inputs and outputs are in use, then the maximum sample rate increases.

| Frame Size | 1 Channel | 2 Channels | 4 Channels | 6 Channels | 8 Channels |
|------------|-----------|------------|------------|------------|------------|
| 1          | 30 KHz    | 30 KHz     | 25 KHz     | 18 KHz     | 15 KHz     |
| 2          | 60 KHz    | 60 KHz     | 45 KHz     | 33 KHz     | 30 KHz     |

These above rates were obtained from testing at The MathWorks. As with all hardware benchmarks, results might vary, depending on a number of hardware conditions. For example, the following hardware elements, among others, might effect your throughput:

- The PCI bus interface chip set on the mother board
- Main memory speed
- General mother board architecture

### Model Notes

**Model Execution Timing** — To run the model, the xPC Target model is executed when each frame completes on the board. Set the simulation parameters to use the interrupt from the Audio-PMC+ rather than the timer interrupt when running the model. First, you need to determine the interrupt vector number to which the board is set. This is determined by the BIOS in the target machine during boot.

- 1 From the MATLAB Command Window, type  
`getxpcpci`

This command lists board information for all installed PCI devices that xPC Target knows about.

- 2 Find the IRQ specified for this board. This is the interrupt source number you need to specify in the **xPC target code generation options** field in step 6 of the following procedure.

Set the interrupt vector number:

- 1 From the MATLAB Command Window, type the name of your Simulink model.

The Simulink model appears

- 2 From the **Simulation** menu, click **Configuration Parameters**.

The Configuration Parameter dialog box is displayed for the model.

- 3 Click the **xPC Target options** node.
- 4 Ensure that the **Execution mode** field is set to Real-Time.
- 5 Click the **Real-time interrupt source** list.
- 6 Select the interrupt number to which the board is set (from step 2 in the previous procedure).
- 7 Click the **I/O board generating the interrupt** list and select AudioPMC+ from the list.
- 8 Click **OK** and save the model.

Failure to set the interrupt vector as described, which results in your using the xPC Target timer, will not stop the model from running. However, you will occasionally see corrupt data since the Audio-PMC+ clock and the xPC Target timer drift relative to each other and will sometimes overlap.

**Example Models** — Two example models are included with this version in the `xpcdemos` directory. Correct operation of either of these requires that the interrupt source be set correctly in the simulation parameters dialog.

`xpc8audiochannels.mdl` shows the use of all 8 input and 8 output channels at the same time. A block from the Signal Processing Blockset is used to convert from frame to sample based signals to drive the xPC Target scopes.

`xpcaudiospectrum.mdl` uses the xPC Target Spectrum Scope subsystem from the `xpcdsppectrum` sample model with the Audio-PMC+ as the source. This model only works correctly with Frame Size set to 1 because of the way that the spectrum scope displays the results.

**Model Execution Limitations** — Model execution is entered each time a frame completes on the Audio-PMC+ board. The frame rate is the fastest clock available. You cannot obtain a minor step execution that runs more frequently than frame completions. Any attempt to do a multirate model must use the frame completion time as the fastest rate. The audio input and audio output blocks must be executed at the fastest rate in the model.

Input and output data from these blocks is in the form of a frame of data as used by the Signal Processing Blockset. If the frame size is 1, then the blocks revert to sample based signals. The blocks in the Signal Processing Blockset expect to see signals that are frames.

# BVM

---

This chapter describes the BVM I/O boards supported by xPC Target (<http://www.bvmltd.co.uk>).

PMCDIO64 (p. 14-2)

A 64-bit digital I/O board with two ports. Each port can be configured to be either 32 independent 1-bit channels or a single 32-bit wide integer channel.

## PMCDIO64

The PMCDIO64 is a 64-bit digital I/O board. The hardware provides 64 bits, which the driver splits into two ports of 32 bits each. Each port can be configured to be either input or output. In addition, each port can be configured to be either 32 independent 1-bit channels or a single 32-bit wide integer channel.

xPC Target supports this board with these driver blocks:

- “PMCDIO64 Digital Input” on page 14-3
- “PMCDIO64 Digital Output” on page 14-4

### Board Characteristics

|                                 |               |
|---------------------------------|---------------|
| Board name                      | PMCDIO64      |
| Manufacturer                    | BVM           |
| Bus type                        | PCI           |
| Access method                   | Memory mapped |
| Multiple block instance support | Yes           |
| Multiple board support          | Yes           |



## PMCDIO64 Digital Input

### Scaling Input to Output

| Hardware Input | Block Output Data Type | Scaling                         |
|----------------|------------------------|---------------------------------|
| TTL            | double                 | TTL low = 0.0<br>TTL high = 1.0 |

### Driver Block Parameters

**Format** — From the list, select either 32 One bit channels or Single 32 bit port.

If the format is 32 One bit channels, then the channel vector specifies the configuration of the block. Each output is a double with value of 0 or 1. The value is 0 when the hardware input voltage is low.

If the format is Single 32 bit port, then the output from the block is a 32-bit integer where all 32 bits on the hardware feed into the single output. The channel vector is not used in this mode and is unavailable on the Block Parameters dialog box. The least significant bit is the lowest numbered bit in the hardware manual.

**Channel vector** — This is a vector of channels. This parameter is only used when the format is 32 One bit channels. Channels are numbered from 1 to 32 even though the hardware manual labels them 0 to 31.

**Port** — Each half of the 64 bits is a separate port. Port 1 is the lower 32 bits and Port 2 is the upper 32 bits. You can use one port for input and the other port for output.

**Sample time** — Enter the base sample time or a multiple of the base sample time.

**PCI Slot (-1:autosearch)** — If only one board of this type is physically present in the target PC, enter

-1

to automatically locate the board.

If two or more boards of this type are physically present in the target PC, enter the bus number and the PCI slot number of the board associated with this driver block. Use the format [BusNumber, SlotNumber]. To determine the bus number and the PCI slot number, type

```
getxpcpci
```

## PMCDIO64 Digital Output

### Scaling Input to Output

| Hardware Output | Block Input Data Type | Scaling                             |
|-----------------|-----------------------|-------------------------------------|
| TTL             | double                | < 0.5 = TTL low<br>≥ 0.5 = TTL high |

### Driver Block Parameters

**Format** — From the list, choose either 32 One bit channels or Single 32 bit port.

If the format is 32 One bit channels, then the channel vector specifies the configuration of the block. Each input is a double. The hardware output is set to low voltage if the input is < 0.5 and high voltage if the input is ≥ 0.5.

If the format is Single 32 bit port, then the input to the block is a 32-bit integer where all 32 bits on the hardware are controlled by the single input. The channel vector is not used in this mode and is unavailable on the Block Parameters dialog box. The least significant bit is the lowest numbered bit in the hardware manual.

**Channel vector** — This is a vector of channels and is only used when the format is 32 One bit channels. Channels are numbered from 1 to 32 even though the hardware manual labels them 0 to 31. Hardware I/O signal numbers IO32 to IO63 are acquired by choosing Port 2 and channels 1 to 32.

**Reset action vector** — If you chose 32 One bit channels, enter a vector of 1's and 0's that is the same length as the channel vector. A value of 1 indicates that the channel is reset to the value in the initial value vector when the model is stopped. A value of 0 indicates that the output remains at the last value written

when the model is stopped. If you enter a scalar value, that value is used for all channels.

If you chose `Single 32 bit port`, enter a 1 or a 0 to determine what happens when the model is stopped. If you enter 1, all 32 bits of the output are reset to the value given by the initial value vector. If you enter 0, the output remains at the last value written when the model is stopped.

**Initial value vector** — If you chose `32 One bit channels`, this vector determines both the initial value of the outputs at xPC boot time and the values when model execution is stopped. A value of 1 for a given channel sets the output for that channel to 1 while any other value sets the output to 0.

If you chose `Single 32 bit port`, enter the scalar value to write to the output port. The value can be a hexadecimal or a decimal. If it is a hexadecimal, then use C syntax. For example, `0xaaaaaaaa` in hexadecimal would be the equivalent of 2863311530 in decimal.

**Port** — Each half of the 64 bits is a separate port. Port 1 is the lower 32 bits and Port 2 is the upper 32 bits. You can use one port for input and the other port for output. In a given model, each port can only be set to one direction.

**Sample time** — Enter the base sample time or a multiple of the base sample time.

**PCI Slot (-1:autosearch)** — If only one board of this type is physically present in the target PC, enter

-1

to automatically locate the board.

If two or more boards of this type are physically present in the target PC, enter the bus number and the PCI slot number of the board associated with this driver block. Use the format `[BusNumber, SlotNumber]`. To determine the bus number and the PCI slot number, type

```
getxpcpci
```



# Contec

---

This chapter describes the Contec I/O boards supported by xPC Target (<http://www.contec.com>).

|                                  |                                                                                                                                                                                                            |
|----------------------------------|------------------------------------------------------------------------------------------------------------------------------------------------------------------------------------------------------------|
| Contec AD12-16(PCI) (p. 15-3)    | I/O board with 16 single-ended or 8 differential analog input (A/D) channels (12 bit), 4 digital input lines, and 4 digital output lines.                                                                  |
| Contec AD12-16(PCI)E (p. 15-8)   | I/O board with 16 single-ended or 8 differential analog input (A/D) channels (12 bit), one analog output channel (12 bit), 4 digital input lines, 4 digital output lines, and an i8254-compatible counter. |
| Contec AD12-16U(PCI)E (p. 15-11) | I/O board with 16 single-ended or 8 differential analog input (A/D) channels (12 bit), one analog output channel (12 bit), 4 digital input lines, 4 digital output lines, and an i8254-compatible counter. |
| Contec ADI12-16(PCI) (p. 15-14)  | I/O board with 16 single-ended or 8 differential analog input (A/D) channels (12 bit), 4 digital input lines, and 4 digital output lines.                                                                  |
| Contec AD12-64(PCI) (p. 15-16)   | I/O board with 64 single-ended or 32 differential analog input (A/D) channels (12 bit), 4 digital input lines, and 4 digital output lines.                                                                 |
| Contec AD16-16(PCI)E (p. 15-21)  | I/O board with 16 single-ended or 8 differential analog input (A/D) channels (16 bit), one analog output channel (16 bit), 4 digital input lines, 4 digital output lines, and an i8254-compatible counter. |
| Contec DA12-4(PCI) (p. 15-24)    | I/O board with 4 analog output (D/A) channels (12 bit).                                                                                                                                                    |
| Contec DA12-16(PCI) (p. 15-26)   | I/O board with 16 analog output (D/A) channels (12 bit).                                                                                                                                                   |

Contec PIO-32/32T(PCI) (p. 15-28)

I/O board with 32 digital input lines and 32 digital output lines.

Contec CNT24-4D(PCI) (p. 15-31)

24-bit differential up/down counter board with four channels.

## Contec AD12-16(PCI)

The Contec AD12-16(PCI) is an I/O board with 16 single-ended or 8 differential analog input (A/D) channels (12 bit), 4 digital input lines, and 4 digital output lines.

xPC Target supports this board with these driver blocks:

- “AD12-16(PCI) Analog Input (A/D)” on page 15-3
- “AD12-16(PCI) Digital Input” on page 15-5
- “AD12-16(PCI) Digital Output” on page 15-6

xPC Target does not support the Counter/Timer functionality of the board.

### Board Characteristics

|                                 |              |
|---------------------------------|--------------|
| Board name                      | AD12-16(PCI) |
| Manufacturer                    | Contec       |
| Bus type                        | PCI          |
| Access method                   | I/O mapped   |
| Multiple block instance support | No           |
| Multiple board support          | Yes          |

## AD12-16(PCI) Analog Input (A/D)

### Scaling Input to Output

| Hardware Input | Block Output Data Type | Scaling |
|----------------|------------------------|---------|
| volts          | Double                 | 1       |

### Driver Block Parameters

**Channel vector** — Enter a vector of numbers to specify the input channels. For example to use the first three analog input (A/D) channels, enter

[1, 2, 3]

The channel numbers can occur in any order. Number the them beginning with 1 even if the board manufacturer numbers them beginning with 0.

The maximum allowable channel number for this board is 8 (double-ended) or 16 (single-ended). If the highest channel number you specify is n, the hardware converts all the channels between 1 and n, whether or not they occur in your channel vector. It is most efficient to specify a contiguous range of channels. (Permuting the order of such a range has no impact on efficiency however.)

**Range vector** — This board allows the range of each channel to be selected independently. Enter a scalar, in which case the same range will be used for all channels, or a vector the same length as the channel vector. The range vector entries must be range codes selected from the following table:

| Input Range (V) | Range Code | Input Range (V) | Range Code |
|-----------------|------------|-----------------|------------|
| -10 to +10      | -10        | 0 to 10         | 10         |
| -5 to +5        | -5         | 0 to 5          | 5          |
| -2.5 to 2.5     | -2         | 0 to 2.5        | 2          |
| -1.25 to 1.25   | -1         | 0 to 1.25       | 1          |

**Polarity** — Choose single-ended or double-ended. This setting applies to all channels.

**Sample time** — Enter the base sample time or a multiple of the base sample time.

**PCI Slot (-1:autosearch)** — If only one board of this type is physically present in the target PC, enter

-1

to automatically locate the board.

If two or more boards of this type are physically present in the target PC, enter the bus number and the PCI slot number of the board associated with this driver block. Use the format [BusNumber, SlotNumber]. To determine the bus number and the PCI slot number, type

```
getxpcpci
```



The Device ID of this board is 8153.

## AD12-16(PCI) Digital Input

### Scaling Input to Output

| Hardware Input | Block Output Data Type | Scaling                         |
|----------------|------------------------|---------------------------------|
| TTL            | Double                 | TTL low = 0.0<br>TTL high = 1.0 |

### Driver Block Parameters

**Channel vector** — Enter a vector of numbers to specify the input channels. For example to use the first and third digital input channels enter

```
[1, 3]
```

The channel numbers can occur in any order. Number the channels beginning with 1 even if the board manufacturer numbers them beginning with 0. The maximum allowable channel number is 4.

**Sample time** — Enter the base sample time or a multiple of the base sample time.

**PCI Slot (-1:autosearch)** — If only one board of this type is physically present in the target PC, enter

```
-1
```

to automatically locate the board.

If two or more boards of this type are physically present in the target PC, enter the bus number and the PCI slot number of the board associated with this driver block. Use the format [BusNumber, SlotNumber]. To determine the bus number and the PCI slot number, type

```
getxpcpci
```

The Device ID of this board is 8153.

## AD12-16(PCI) Digital Output

### Scaling Input to Output

| Hardware Output | Block Input Data Type | Scaling                           |
|-----------------|-----------------------|-----------------------------------|
| TTL             | Double                | < 0.5 = TTL low<br>> 0.5 TTL high |

### Driver Block Parameters

**Channel vector** — Enter a vector of numbers to specify the output channels. For example, to use the first and third digital output channels enter

[1, 3]

The channel numbers can occur in any order. Number the channels beginning with 1 even if the board manufacturer numbers them beginning with 0. The maximum allowable channel number is 4.

**Reset vector** — The reset vector controls the behavior of the channel at model termination. Enter a scalar or a vector that is the same length as the channel vector. If you specify a scalar value, that setting is used for all channels. If you specify a value of 1, the corresponding channel is reset to the value specified in the initial value vector. If you specify a value of 0, the channel remains at the last value attained while the model was running.

**Initial value vector** — The initial value vector contains the initial values (0 or 1) of the output channels. Enter a scalar or a vector that is the same length as the channel vector. If you enter a scalar, that value is used for all channels. The channels are set to these initial values between the time the model is downloaded and the time it is started.

**Sample time** — Enter the base sample time or a multiple of the base sample time.

**PCI Slot (-1:autosearch)** — If only one board of this type is physically present in the target PC, enter

-1

to automatically locate the board.

If two or more boards of this type are physically present in the target PC, enter the bus number and the PCI slot number of the board associated with this driver block. Use the format [BusNumber, SlotNumber]. To determine the bus number and the PCI slot number, type

```
getxpcpci
```

The Device ID of this board is 8153.

## Contec AD12-16(PCI)E

The Contec AD12-16(PCI)E is an I/O board with 16 single-ended or 8 differential analog input (A/D) channels (12 bit), one analog output channel (12 bit), 4 digital input lines, 4 digital output lines, and an i8254-compatible counter.

xPC Target supports this board with these driver blocks:

- “AD12-16(PCI)E Analog Input (A/D)” on page 15-8
- “AD12-16(PCI)E Analog Output (D/A)” on page 15-10

xPC Target does not support the digital I/O or Counter/Timer functionality of the board.

### Board Characteristics

|                                 |               |
|---------------------------------|---------------|
| Board name                      | AD12-16(PCI)E |
| Manufacturer                    | Contec        |
| Bus type                        | PCI           |
| Access method                   | I/O mapped    |
| Multiple block instance support | No            |
| Multiple board support          | Yes           |

## AD12-16(PCI)E Analog Input (A/D)

### Scaling Input to Output

| Hardware Input | Block Output Data Type | Scaling |
|----------------|------------------------|---------|
| volts          | Double                 | 1       |

### Driver Block Parameters

**Channel vector** — Enter a vector of numbers to specify the input channels. For example, to use the first three analog input (A/D) channels, enter

[1, 2, 3]

The channel numbers can occur in any order. Number them beginning with 1 even if the board manufacturer numbers them beginning with 0. The maximum allowable channel number for this board is 8 (double-ended) or 16 (single-ended).

**Gain vector** — To specify the gain, enter 1, 2, 4, or 8 for each of the channels in the channel vector. The gain vector must be the same length as the channel vector. If you enter a scalar, the value is applied to all channels.

The gain is applied to the signal prior to sampling the voltage. After the signal voltage is sampled, the result is divided by the gain to obtain the block output signal value. To avoid clipping, make sure that the amplified gain falls within the range you selected.

**Range** — From the list, select Bipolar -10V to +10V or Unipolar 0V to +10V. This range applies to all channels.

**Sample time** — Enter the base sample time or a multiple of the base sample time.

**PCI Slot (-1:autosearch)** — If only one board of this type is physically present in the target PC, enter

-1

to automatically locate the board.

If two or more boards of this type are physically present in the target PC, enter the bus number and the PCI slot number of the board associated with this driver block. Use the format [BusNumber, SlotNumber]. To determine the bus number and the PCI slot number, type

```
getxpcpci
```

Note that the Device ID of this board is 8113.

## AD12-16(PCI)E Analog Output (D/A)

### Scaling Input to Output

| Hardware Output | Block Input Data Type | Scaling |
|-----------------|-----------------------|---------|
| volts           | Double                | 1       |

### Driver Block Parameters

**Range** — From the list, select -5V to +5V, -10V to +10V, or 0 to +10V as the output range for the analog output. This range must correspond to the output range determined by the jumpers on the board.

**Reset** — This check box controls the behavior of the output channel at model termination. If the check box is selected, the output channel is reset to the value specified as the initial value. If the check box is not selected, the output channel remains at the most recent value attained while the model was running.

**Initial value** — Enter the initial voltage value for the output channel. The output channel is set to this value between the time the model is downloaded and the time the model is started. Also, if the reset check box is selected, the output channel is reset to the initial value when the model is stopped.

**Sample time** — Enter the base sample time or a multiple of the base sample time.

**PCI Slot (-1:autosearch)** — If only one board of this type is physically present in the target PC, enter

-1

to automatically locate the board.

If two or more boards of this type are physically present in the target PC, enter the bus number and the PCI slot number of the board associated with this driver block. Use the format [BusNumber, SlotNumber]. To determine the bus number and the PCI slot number, type

```
getxpcpci
```

Note that the Device ID of this board is 8113.

## Contec AD12-16U(PCI)E

The Contec AD12-16U(PCI)E is an I/O board with 16 single-ended or 8 differential analog input (A/D) channels (12 bit), one analog output channel (12 bit), 4 digital input lines, 4 digital output lines, and an i8254-compatible counter.

xPC Target supports this board with these driver blocks:

- “AD12-16U(PCI)E Analog Input (A/D)” on page 15-11
- “AD12-16U(PCI)E Analog Output (D/A)” on page 15-12

xPC Target does not support the digital I/O or Counter/Timer functionality of the board.

### Board Characteristics

|                                 |                |
|---------------------------------|----------------|
| Board name                      | AD12-16U(PCI)E |
| Manufacturer                    | Contec         |
| Bus type                        | PCI            |
| Access method                   | I/O mapped     |
| Multiple block instance support | No             |
| Multiple board support          | Yes            |

### AD12-16U(PCI)E Analog Input (A/D)

#### Scaling Input to Output

| Hardware Input | Block Output Data Type | Scaling |
|----------------|------------------------|---------|
| volts          | Double                 | 1       |

#### Driver Block Parameters

**Channel vector** — Enter a vector of numbers to specify the input channels. For example, to use the first three analog input (A/D) channels, enter

[ 1, 2, 3 ]

The channel numbers can occur in any order. Number them beginning with 1 even if the board manufacturer numbers them beginning with 0. The maximum allowable channel number for this board is 8 (double-ended) or 16 (single-ended).

**Range** — From the list, select Bipolar -2.5V to +2.5V, Bipolar -5V to +5V, Unipolar 0V to +5V, or Unipolar 0V to +10V. This range applies to all channels.

**Sample time** — Enter the base sample time or a multiple of the base sample time.

**PCI Slot (-1:autosearch)** — If only one board of this type is physically present in the target PC, enter

-1

to automatically locate the board.

If two or more boards of this type are physically present in the target PC, enter the bus number and the PCI slot number of the board associated with this driver block. Use the format [BusNumber, SlotNumber]. To determine the bus number and the PCI slot number, type

```
getxpcpci
```

Note that the Device ID of this board is 8103.

## AD12-16U(PCI)E Analog Output (D/A)

### Scaling Input to Output

| Hardware Output | Block Input Data Type | Scaling |
|-----------------|-----------------------|---------|
| volts           | Double                | 1       |

### Driver Block Parameters

**Range** — From the list, select -5V to +5V, -10V to +10V, or 0 to +10V as the output range for the analog output. This range must correspond to the output range determined by the jumpers on the board.



**Reset** — This check box controls the behavior of the output channel at model termination. If the check box is selected, the output channel is reset to the value specified as the initial value. If the check box is not selected, the output channel remains at the most recent value attained while the model was running.

**Initial value** — Enter the initial voltage value for the output channel. The output channel is set to this value between the time the model is downloaded and the time the model is started. Also, if the reset check box is selected, the output channel is reset to the initial value when the model is stopped.

**Sample time** — Enter the base sample time or a multiple of the base sample time.

**PCI Slot (-1:autosearch)** — If only one board of this type is physically present in the target PC, enter

-1

to automatically locate the board.

If two or more boards of this type are physically present in the target PC, enter the bus number and the PCI slot number of the board associated with this driver block. Use the format [BusNumber, SlotNumber]. To determine the bus number and the PCI slot number, type

```
getxpcpci
```

Note that the Device ID of this board is 8103.

## Contec ADI12-16(PCI)

The Contec ADI12-16(PCI) is an I/O board with 16 single-ended or 8 differential analog input (A/D) channels (12 bit), 4 digital input lines, and 4 digital output lines.

### Board Characteristics

|                                 |               |
|---------------------------------|---------------|
| Board name                      | ADI12-16(PCI) |
| Manufacturer                    | Contec        |
| Bus type                        | PCI           |
| Access method                   | I/O mapped    |
| Multiple block instance support | No            |
| Multiple board support          | Yes           |

### ADI12-16(PCI) Analog Input (A/D)

#### Scaling Input to Output

| Hardware Output | Block Input Data Type | Scaling |
|-----------------|-----------------------|---------|
| volts           | Double                | 1       |

### Driver Block Parameters

**Channel vector** — Enter a vector of numbers to specify the input channels. For example, to use the first three analog input (A/D) channels, enter

[ 1, 2, 3 ]

The channel numbers can occur in any order. Number them beginning with 1 even if the board manufacturer numbers them beginning with 0. The maximum allowable channel number for this board is 8 (double-ended) or 16 (single-ended).

**Gain vector** — To specify the gain, enter 1, 2, 4, or 8 for each of the channels in the channel vector. The gain vector must be the same length as the channel vector. If you enter a scalar, the value is applied to all channels.

The gain is applied to the signal prior to sampling the voltage. After the signal voltage is sampled, the result is divided by the gain to obtain the block output signal value. To avoid clipping, make sure that the amplified gain falls within the range you selected.

**Range** — From the list, select Bipolar -10V to +10V, Unipolar 0V to +10V, or Unipolar 4mA to 20mA. Choose a range that is consistent with the jumper settings on the board. This range applies to all channels.

**Sample time** — Enter the base sample time or a multiple of the base sample time.

**PCI Slot (-1:autosearch)** — If only one board of this type is physically present in the target PC, enter

-1

to automatically locate the board.

If two or more boards of this type are physically present in the target PC, enter the bus number and the PCI slot number of the board associated with this driver block. Use the format [BusNumber, SlotNumber]. To determine the bus number and the PCI slot number, type

```
getxpcpci
```

Note that the Device ID of this board is 8133.

## Contec AD12-64(PCI)

The Contec AD12-64(PCI) is an I/O board with 64 single-ended or 32 differential analog input (A/D) channels (12 bit), 4 digital input lines, and 4 digital output lines.

xPC Target supports this board with these driver blocks:

- “AD12-64(PCI) Analog Input (A/D)” on page 15-16
- “AD12-64(PCI) Digital Input” on page 15-18
- “AD12-64(PCI) Digital Output” on page 15-19

xPC Target does not support the Counter/Timer functionality of this board.

### Board Characteristics

|                                 |              |
|---------------------------------|--------------|
| Board name                      | AD12-64(PCI) |
| Manufacturer                    | Contec       |
| Bus type                        | PCI          |
| Access method                   | I/O mapped   |
| Multiple block instance support | No           |
| Multiple board support          | Yes          |

## AD12-64(PCI) Analog Input (A/D)

### Scaling Input to Output

| Hardware Input | Block Output Data Type | Scaling |
|----------------|------------------------|---------|
| volts          | Double                 | 1       |

### Driver Block Parameters

**Channel vector** — Enter a vector of numbers to specify the input channels. For example, to use the first three analog input (A/D) channels, enter

[1, 2, 3]

The channel numbers can occur in any order. Number the them beginning with 1 even if the board manufacturer numbers them beginning with 0.

The maximum allowable channel number for this board is 32 (double-ended) or 64 (single-ended). If the highest channel number you specify is  $n$ , the hardware will convert all the channels between 1 and  $n$ , whether or not they occur in your channel vector. It is most efficient to specify a contiguous range of channels. (Permuting the order of such a range has no impact on efficiency however.)

**Range vector** — This board allows the range of each channel to be selected independently. If you enter a scalar, the same range is used for all channels. If you enter a vector, it must be the same length as the channel vector. The range vector entries must be range codes selected from the following table:

| Input Range (V) | Range Code | Input Range (V) | Range Code |
|-----------------|------------|-----------------|------------|
| -10 to +10      | -10        | 0 to 10         | 10         |
| -5 to +5        | -5         | 0 to 5          | 5          |
| -2.5 to 2.5     | -2         | 0 to 2.5        | 2          |
| -1.25 to 1.25   | -1         | 0 to 1.25       | 1          |

**Polarity** — Choose single-ended or double-ended. This setting applies to all channels.

**Sample time** — Enter the base sample time or a multiple of the base sample time.

**PCI Slot (-1:autosearch)** — If only one board of this type is physically present in the target PC, enter

-1

to automatically locate the board.

If two or more boards of this type are physically present in the target PC, enter the bus number and the PCI slot number of the board associated with this driver block. Use the format [BusNumber, SlotNumber]. To determine the bus number and the PCI slot number, type

```
getxpcpci
```

The Device ID of this board is 8143.

## AD12-64(PCI) Digital Input

### Scaling Input to Output

| Hardware Input | Block Output Data Type | Scaling                         |
|----------------|------------------------|---------------------------------|
| TTL            | Double                 | TTL low = 0.0<br>TTL high = 1.0 |

### Driver Block Parameters

**Channel vector** — Enter a vector of numbers to specify the input channels. For example, to use the first and third digital input channels enter

```
[1, 3]
```

The channel numbers can occur in any order. Number the channels beginning with 1 even if the board manufacturer numbers them beginning with 0. The maximum allowable channel number is 4.

**Sample time** — Enter the base sample time or a multiple of the base sample time.

**PCI Slot (-1:autosearch)** — If only one board of this type is physically present in the target PC, enter

```
-1
```

to automatically locate the board.

If two or more boards of this type are physically present in the target PC, enter the bus number and the PCI slot number of the board associated with this driver block. Use the format [BusNumber, SlotNumber]. To determine the bus number and the PCI slot number, type

```
getxpcpci
```

The Device ID of this board is 8143.

## AD12-64(PCI) Digital Output

### Scaling Input to Output

| Hardware Output | Block Input Data Type | Scaling                           |
|-----------------|-----------------------|-----------------------------------|
| TTL             | Double                | < 0.5 = TTL low<br>> 0.5 TTL high |

### Driver Block Parameters

**Channel vector** — Enter a vector of numbers to specify the output channels. For example, to use the first and third digital output channels enter

[1, 3]

The channel numbers can occur in any order. Number the channels beginning with 1 even if the board manufacturer numbers them beginning with 0. The maximum allowable channel number is 4.

**Reset vector** — The reset vector controls the behavior of the channel at model termination. Enter a scalar or a vector that is the same length as the channel vector. If you specify a scalar value, that setting is used for all channels. If you specify a value of 1, the corresponding channel is reset to the value specified in the initial value vector. If you specify a value of 0, the channel remains at the last value attained while the model was running.

**Initial value vector** — The initial value vector contains the initial voltage values (0 or 1) for the output channels. Enter a scalar or a vector that is the same length as the channel vector. If you specify a scalar value, that value is the initial value for all channels. The channels are set to the initial values between the time the model is downloaded and the time it is started.

**Sample time** — Enter the base sample time or a multiple of the base sample time.

**PCI Slot (-1:autosearch)** — If only one board of this type is physically present in the target PC, enter

-1

to automatically locate the board.

If two or more boards of this type are physically present in the target PC, enter the bus number and the PCI slot number of the board associated with this driver block. Use the format [BusNumber, SlotNumber]. To determine the bus number and the PCI slot number, type

```
getxpcpci
```

The Device ID of this board is 8143.



## Contec AD16-16(PCI)E

The Contec AD16-16(PCI)E is an I/O board with 16 single-ended or 8 differential analog input (A/D) channels (16 bit), one analog output channel (16 bit), 4 digital input lines, 4 digital output lines, and an i8254-compatible counter.

xPC Target supports this board with these driver blocks:

- “AD16-16(PCI)E Analog Input (A/D)” on page 15-21
- “AD16-16(PCI)E Analog Output (D/A)” on page 15-22

xPC Target does not support the digital I/O or Counter/Timer functionality of the board.

### Board Characteristics

|                                 |               |
|---------------------------------|---------------|
| Board name                      | AD16-16(PCI)E |
| Manufacturer                    | Contec        |
| Bus type                        | PCI           |
| Access method                   | I/O mapped    |
| Multiple block instance support | No            |
| Multiple board support          | Yes           |

### AD16-16(PCI)E Analog Input (A/D)

#### Scaling Input to Output

| Hardware Input | Block Output Data Type | Scaling |
|----------------|------------------------|---------|
| volts          | Double                 | 1       |

#### Driver Block Parameters

**Channel vector** — Enter a vector of numbers to specify the input channels. For example, to use the first three analog input (A/D) channels, enter

[ 1, 2, 3 ]

The channel numbers can occur in any order. Number them beginning with 1 even if the board manufacturer numbers them beginning with 0. The maximum allowable channel number for this board is 8 (double-ended) or 16 (single-ended).

**Range** — From the list, select Bipolar -10V to +10V, Bipolar -5V to +5V, Unipolar 0V to +5V, or Unipolar 0V to +10V. This range applies to all channels.

**Sample time** — Enter the base sample time or a multiple of the base sample time.

**PCI Slot (-1:autosearch)** — If only one board of this type is physically present in the target PC, enter

-1

to automatically locate the board.

If two or more boards of this type are physically present in the target PC, enter the bus number and the PCI slot number of the board associated with this driver block. Use the format [BusNumber, SlotNumber]. To determine the bus number and the PCI slot number, type

```
getxpcpci
```

Note that the Device ID of this board is 8123.

## **AD16-16(PCI)E Analog Output (D/A)**

### **Scaling Input to Output**

| <b>Hardware Output</b> | <b>Block Input Data Type</b> | <b>Scaling</b> |
|------------------------|------------------------------|----------------|
| volts                  | Double                       | 1              |

### **Driver Block Parameters**

**Range** — From the list, select -5V to +5V, -10V to +10V, or 0 to +10V as the output range for the analog output. This range must correspond to the output range determined by the jumpers on the board.

**Reset** — This check box controls the behavior of the output channel at model termination. If the check box is selected, the output channel is reset to the value specified as the initial value. If the check box is not selected, the output channel remains at the most recent value attained while the model was running.

**Initial value** — Enter the initial voltage value for the output channel. The output channel is set to this value between the time the model is downloaded and the time the model is started. Also, if the reset check box is selected, the output channel is reset to the initial value when the model is stopped.

**Sample time** — Enter the base sample time or a multiple of the base sample time.

**PCI Slot (-1:autosearch)** — If only one board of this type is physically present in the target PC, enter

-1

to automatically locate the board.

If two or more boards of this type are physically present in the target PC, enter the bus number and the PCI slot number of the board associated with this driver block. Use the format [BusNumber, SlotNumber]. To determine the bus number and the PCI slot number, type

```
getxpcpci
```

Note that the Device ID of this board is 8123.

## Contec DA12-4(PCI)

The Contec DA12-4(PCI) is an I/O board with 4 analog output (D/A) channels (12 bit).

xPC Target supports this board with this driver block:

- “DA12-4(PCI) Analog Output (D/A)” on page 15-24

xPC Target does not support the timer, external trigger, or interrupt functionality of this board.

### Board Characteristics

|                                 |             |
|---------------------------------|-------------|
| Board name                      | DA12-4(PCI) |
| Manufacturer                    | Contec      |
| Bus type                        | PCI         |
| Access method                   | I/O mapped  |
| Multiple block instance support | No          |
| Multiple board support          | Yes         |

## DA12-4(PCI) Analog Output (D/A)

### Scaling Input to Output

| Hardware Output | Block Input Data Type | Scaling |
|-----------------|-----------------------|---------|
| volts           | Double                | 1       |

### Driver Block Parameters

**Channel vector** — Enter a vector of numbers to specify the output channels. For example, to use the first and second analog output (D/A) channels enter

[1, 2]

The channel numbers can occur in any order. Number the channels beginning with 1 even if the board manufacturer numbers them beginning with 0. The maximum allowable channel number is 4.

**Reset vector** — The reset vector controls the behavior of the channel at model termination. Enter a scalar or a vector that is the same length as the channel vector. If you specify a scalar value, that setting is used for all channels. If you specify a value of 1, the corresponding channel is reset to the value specified in the initial value vector. If you specify a value of 0, the channel remains at the last value attained while the model was running.

**Initial value vector** — The initial value vector contains the initial voltage values for the output channels. Enter a scalar or a vector that is the same length as the channel vector. If you specify a scalar value, that value is the initial value for all channels. The channels are set to the initial values between the time the model is downloaded and the time it is started.

**Sample time** — Enter the base sample time or a multiple of the base sample time.

**PCI Slot (-1:autosearch)** — If only one board of this type is physically present in the target PC, enter

-1

to automatically locate the board.

If two or more boards of this type are physically present in the target PC, enter the bus number and the PCI slot number of the board associated with this driver block. Use the format [BusNumber, SlotNumber]. To determine the bus number and the PCI slot number, type

```
getxpcpci
```

The Device ID of this board is 8183.

## Contec DA12-16(PCI)

The Contec DA12-16(PCI) is an I/O board with 16 analog output (D/A) channels (12 bit).

xPC Target supports this board with this driver block:

- “DA12-16(PCI) Analog Output (D/A)” on page 15-26

xPC Target does not support the timer, external trigger, or interrupt functionality of this board.

### Board Characteristics

|                                 |              |
|---------------------------------|--------------|
| Board name                      | DA12-16(PCI) |
| Manufacturer                    | Contec       |
| Bus type                        | PCI          |
| Access method                   | I/O mapped   |
| Multiple block instance support | No           |
| Multiple board support          | Yes          |

## DA12-16(PCI) Analog Output (D/A)

### Scaling Input to Output

| Hardware Output | Block Input Data Type | Scaling |
|-----------------|-----------------------|---------|
| volts           | Double                | 1       |

### Driver Block Parameters

**Channel vector** — Enter a vector of numbers to specify the output channels. For example, to use the first and second analog output (D/A) channels enter

[1, 2]

The channel numbers can occur in any order. Number the channels beginning with 1 even if the board manufacturer numbers them beginning with 0. The maximum allowable channel number is 16.

**Reset vector** — The reset vector controls the behavior of the channel at model termination. Enter a scalar or a vector that is the same length as the channel vector. If you specify a scalar value, that setting is used for all channels. If you specify a value of 1, the corresponding channel is reset to the value specified in the initial value vector. If you specify a value of 0, the channel remains at the last value attained while the model was running.

**Initial value vector** — The initial value vector contains the initial voltage values for the output channels. Enter a scalar or a vector that is the same length as the channel vector. If you specify a scalar value, that value is the initial value for all channels. The channels are set to the initial values between the time the model is downloaded and the time it is started.

**Sample time** — Enter the base sample time or a multiple of the base sample time.

**PCI Slot (-1:autosearch)** — If only one board of this type is physically present in the target PC, enter

-1

to automatically locate the board.

If two or more boards of this type are physically present in the target PC, enter the bus number and the PCI slot number of the board associated with this driver block. Use the format [BusNumber, SlotNumber]. To determine the bus number and the PCI slot number, type

```
getxpcpci
```

The Device ID of this board is 8163.

## Contec PIO-32/32T(PCI)

The Contec PIO-32/32T(PCI) is an I/O board with 32 digital input channels and 32 output channels.

xPC Target supports this board with these driver blocks:

- “PIO-32/32T(PCI) Digital Input” on page 15-28
- “PIO-32/32T(PCI) Digital Output” on page 15-29

xPC Target does not support the timer, external trigger, or interrupt functionality of this board.

### Board Characteristics

|                                 |                 |
|---------------------------------|-----------------|
| Board name                      | PIO-32/32T(PCI) |
| Manufacturer                    | Contec          |
| Bus type                        | PCI             |
| Access method                   | I/O mapped      |
| Multiple block instance support | No              |
| Multiple board support          | Yes             |

## PIO-32/32T(PCI) Digital Input

### Scaling Input to Output

| Hardware Input | Block Output Data Type | Scaling                         |
|----------------|------------------------|---------------------------------|
| TTL            | Double                 | TTL low = 0.0<br>TTL high = 1.0 |

### Driver Block Parameters

**I/O format** — Select `serial` or `parallel`. If you select `serial`, the block is configured to accept up to 32 one-bit input channels. If you select `parallel`, the block is configured to accept a single 32-bit input channel and the channel vector parameter is unavailable.



**Channel vector** — If you selected serial I/O format, enter a vector of numbers to specify the input channels for serial I/O format. For example, to use the first and third digital input channels enter

```
[ 1, 3 ]
```

The channel numbers can occur in any order, but the numbers must lie in the range 1 to 32.

**Sample time** — Enter the base sample time or a multiple of the base sample time.

**PCI Slot (-1:autosearch)** — If only one board of this type is physically present in the target PC, enter

```
- 1
```

to automatically locate the board.

If two or more boards of this type are physically present in the target PC, enter the bus number and the PCI slot number of the board associated with this driver block. Use the format [BusNumber, SlotNumber]. To determine the bus number and the PCI slot number, type

```
getxpcpci
```

The Device ID of this board is 8152.

## PIO-32/32T(PCI) Digital Output

### Scaling Input to Output

| Hardware Output | Block Input Data Type | Scaling                           |
|-----------------|-----------------------|-----------------------------------|
| TTL             | Double                | < 0.5 = TTL low<br>> 0.5 TTL high |

### Driver Block Parameters

**I/O format** — Select serial or parallel. If you select serial, the block is configured to accept up to 32 one-bit input channels for output. If you select parallel, the block is configured to accept a single 32-bit channel and the channel vector parameter is unavailable.

**Channel vector** — For serial I/O format, enter a vector of numbers to specify the output channels. For example to use the first and third digital output channels enter

```
[1, 3]
```

The channel numbers can occur in any order, but the numbers must lie in the range 1 to 32.

**Reset vector** — The reset vector controls the behavior of the channel at model termination. Enter a scalar or a vector that is the same length as the channel vector. If you specify a scalar value, that setting is used for all channels. If you specify a value of 1, the corresponding channel is reset to the value specified in the initial value vector. If you specify a value of 0, the channel remains at the last value attained while the model was running.

**Initial value vector** — The initial value vector contains the initial voltage values (0 or 1) for the output channels. Enter a scalar or a vector that is the same length as the channel vector. If you specify a scalar value, that value is the initial value for all channels. The channels are set to the initial values between the time the model is downloaded and the time it is started. If you selected parallel I/O format, the values can be in the form [hex2dec('ffffff')].

**Sample time** — Enter the base sample time or a multiple of the base sample time.

**PCI Slot (-1:autosearch)** — If only one board of this type is physically present in the target PC, enter

```
-1
```

to automatically locate the board.

If two or more boards of this type are physically present in the target PC, enter the bus number and the PCI slot number of the board associated with this driver block. Use the format [BusNumber, SlotNumber]. To determine the bus number and the PCI slot number, type

```
getxpcpci
```

The Device ID of this board is 8152.

## Contec CNT24-4D(PCI)

The Contec CNT24-4D(PCI) is a 24-bit differential up/down counter board with four channels. This board typically connects to incremental encoders. Incremental encoders convert physical motion into electrical pulses that can be used to determine velocity, direction, and distance.

xPC Target supports this board with one driver block:

- “CNT24-4D(PCI) Incremental Encoder” on page 15-31

xPC Target does not support the timer or interrupt functionality of this board.

### Board Characteristics

|                                 |               |
|---------------------------------|---------------|
| Board name                      | CNT24-4D(PCI) |
| Manufacturer                    | Contec        |
| Bus type                        | PCI           |
| Access method                   | I/O mapped    |
| Multiple block instance support | No            |
| Multiple board support          | Yes           |

## CNT24-4D(PCI) Incremental Encoder

### Driver Block Parameters

Note that you can have only one driver block instance for each physical board. If you need to use multiple channels, select and enable more than channel on the same block.

**Channel** — From the list, select 1, 2, 3, or 4. This parameter specifies the channel to which the subsequent parameters refer. The other parameters in this block apply to this channel. The **Enable channel** check box number changes to match the selected channel.

**Enable channel** — Select this check box to enable the currently selected channel. Click **OK** after you select this check box to add an output port for the channel on the driver instance of your model. This check box also enables you to set a number of operation parameters for the block, ranging from **Input type** to **Initial count**. Whatever operation parameters are in place when you click **OK** are preserved for the channel until the next time you change them.

The following are some additional behavior notes for this check box:

- If you do not select this check box for a channel, an output port for that channel is not added to the block. You also cannot change the operation parameters for the channel.
- If you select this check box and save the operation parameters for that channel, then later deselect this check box, the block preserves the operation parameters for the channel. The output port is removed from the block.

**Input type** — From the list, choose either `Line receiver` or `TTL-level input`. This parameter specifies the input type for the current channel.

**Mode** — From the list, select the counter operation mode for the current channel. There are a number of modes, based on 1-phase or 2-phase pulse inputs. See the Contec CNT24-4D(PCI) user's guide documentation for descriptions of these modes.

Note that of this list of modes, the `Multiply by 4` modes are synonyms for quadrature encoding.

**Direction** — From the list, select either `Clockwise rotation counts down` or `Clockwise rotation counts up` as the counter direction of the current channel.

**Phase Z logic** — From the list, select either `Active high` or `Active low` for the current channel. This parameter specifies the state of the phase Z input (reference position signal). If the **phase Z mode** parameter has a value of `Disable phase Z input`, **Phase Z logic** has no effect.

**Phase Z mode** — From the list, select either `Disable phase Z input`, `Enable next phase Z input only once`, or `Enable every phase Z input`. This parameter specifies the operation mode of the phase Z input for the current channel.

**Digital filter** — From the list, select the characteristics of the digital input filter you want to apply to the current channel's input signal. There are a number of sampling cycles to choose from, ranging from 0.1 microseconds (1 MHz) to 1056.1 microseconds (94 Hz).

**Initial count** — Enter a number from 0 to 16777215 (FFFFFF hex, the largest 24-bit number). This parameter specifies the initial value of the counter for the current channel.

**Sample time** — Enter the base sample time or a multiple of the base sample time.

**PCI Slot (-1:autosearch)** — If only one board of this type is physically present in the target PC, enter

-1

to automatically locate the board.

If two or more boards of this type are physically present in the target PC, enter the bus number and the PCI slot number of the board associated with this driver block. Use the format [BusNumber, SlotNumber]. To determine the bus number and the PCI slot number, type

```
getxpcpci
```

The Device ID of this board is 8163.



# Data Translation

---

I/O boards supported by xPC Target. (<http://www.datx.com>)

DT2821 (p. 16-3)

I/O board with 16 single-ended or 8 differential analog input (A/D) channels, 2 analog output (D/A) channels, and 16 digital I/O lines that can be configured in groups of 8 for either input or output.

DT2821-F-8DI (p. 16-8)

I/O board with 8 differential analog input (A/D) channels, 2 analog output (D/A) channels, and 16 digital I/O lines that can be configured in groups of 8 for either input or output.

DT2821-G-8DI (p. 16-13)

I/O board with 8 differential analog input (A/D) channels, 2 analog output (D/A) channels, and 16 digital I/O lines that can be configured in groups of 8 for either input or output.

DT2821-F-16SE (p. 16-18)

I/O board with 16 single-ended analog input (A/D) channels, 2 analog output (D/A) channels, and 16 digital I/O lines that can be configured in groups of 8 for either input or output

DT2821-G-16SE (p. 16-23)

I/O board with 16 single-ended analog input (A/D) channels, 2 analog output (D/A) channels (12-bit), and 16 digital I/O lines that can be configured in groups of 8 for either input or output.

DT2823 (p. 16-28)

I/O board 4 differential analog input (A/D) channels, 2 analog output (D/A) channels, and 16 digital I/O lines that can be configured in groups of 8 for either input or output.

DT2824-PGH (p. 16-33)

I/O board with 16 single-ended or 8 differential analog input (A/D) channels, 2 analog output (D/A) channels, and 16 digital I/O lines that can be configured in groups of 8 for either input or output.

DT2824-PGL (p. 16-37)

I/O board with 16 single-ended or 8 differential analog input (A/D) channels, 2 analog output (D/A) channels, and 16 digital I/O lines that can be configured in groups of 8 for either input or output.

DT2825 (p. 16-41)

I/O board with 16 single-ended or 8 differential analog input (A/D) channels, 2 analog output (D/A) channels, and 16 digital I/O lines that can be configured in groups of 8 for either input or output.

DT2827 (p. 16-46)

I/O board with 4 differential analog input (A/D) channels, 2 analog output (D/A) channels, and 16 digital I/O lines that can be configured in groups of 8 for either input or output.

DT2828 (p. 16-51)

I/O board with 4 single-ended analog input (A/D) channels, 2 analog output (D/A) channels, and 16 digital I/O lines that can be configured in groups of 8 for either input or output.



## DT2821

The DT2821 is an I/O board with 16 single-ended or 8 differential analog input (A/D) channels (12-bit) with a maximum sample rate of 50 kHz, 2 analog output (D/A) channels (12-bit), and 16 digital I/O lines that can be configured in groups of 8 for either input or output.

xPC Target supports this board with these driver blocks:

- “DT2821 Analog Input (A/D)” on page 16-3
- “DT2821 Analog Output (D/A)” on page 16-5
- “DT2821 Digital Input” on page 16-6
- “DT2821 Digital Output” on page 16-7

### Board Characteristics

|                                 |                                 |
|---------------------------------|---------------------------------|
| Board Name                      | DT2821                          |
| Manufacturer                    | Data Translation                |
| Bus Type                        | ISA                             |
| Access Method                   | I/O mapped                      |
| Multiple block instance support | A/D:No, D/A:No, Digital I/O:Yes |
| Multiple board support          | Yes                             |

### DT2821 Analog Input (A/D)

#### Scaling of Input to Output

| Hardware Input | Block Output Data Type | Scaling |
|----------------|------------------------|---------|
| volts          | Double                 | 1       |

### Driver Block Parameters

**Channel vector** — If you choose Single-ended (16 channels) from the **Input coupling** list, enter numbers between 1 and 16. If you choose Differential (8 channels) from the **Input coupling** list, enter numbers between 1 and 8. For example, to use the first and third analog output (A/D) channels, enter

[1,3]

Number the channels beginning with 1 even if the board manufacturer starts to number the channels with 0.

**Gain vector** — Enter 1, 2, 4, or 8 for each of the channels in the **Channel vector** to specify the gain for that channel. The gain vector must be the same length as the **Channel vector**. (If you enter a scalar, it is automatically expanded to channel vector). This driver allows the gain of each channel to be different. The gain is applied prior to sampling the voltage.

For example, if you have an input signal from -1 to +1 volts, and a gain of 8, the signal is amplified -8 to +8 volts. Select a range equal or larger than the amplified voltage. For example, select a range of + -10V. After the signal voltage is sampled, this block divides by the gain to output the original signal value.

**Range** — From the list, choose either + -10V (-10 volts to +10 volts), or 0-10V (0 volts to +10 volts). This specifies the effective range which is the same for all channels and must correspond with the input range setting on the board.

**Input coupling** — From the list, select one from the following list of input modes:

- Single-ended channels (16 channels)
- Differential channels (8 channels)

This choice must correspond to the input mode setting on the board.

**Sample time** — Enter the base sample time or a multiple of the base sample time.

**Base address** — Enter the base address of the board. It is important that this entry corresponds to the base address setting on the board. For example, if the base address is 300 (hexadecimal), enter

0x300

## DT2821 Analog Output (D/A)

### Scaling of Input to Output

| Hardware Output | Block Input Data Type | Scaling |
|-----------------|-----------------------|---------|
| volts           | Double                | 1       |

### Driver Block Parameter

**Channel vector** — Enter numbers between 1 and 2. This driver allows the selection of individual D/A channels in any order. The number of elements defines the number of D/A channels you use. For example, to use the first and second analog output (D/A) channels, enter

[ 1, 2 ]

Number the channels beginning with 1 even if the board manufacturer starts numbering the channels with 0.

**Range vector** — Enter a range code for each of the channels in the **Channel vector**. The range vector must be the same length as the **Channel vector**. This board allows the range of each channel to be different.

The following table is a list of the ranges for this driver and the corresponding range codes.

| Input Range (V) | Range Code | Input Range (V) | Range Code |
|-----------------|------------|-----------------|------------|
| -10 to +10      | -10        | 0 to +5         | 5          |
| -5 to +5        | -5         | 0 to +10        | 10         |
| -2.5 to +2.5    | -2.5       |                 |            |

For example, if the first channel is -10 to +10 volts, and the second channel is 0 to 5 volts, enter

[ -10, 5 ]

The range settings have to correspond to the Output Range Selection settings on the board for DAC0, and DAC1 (channel 1 and 2 respectively).

**Sample time** — Base sample time of a multiple of the base sample time.

**Base address** — Enter the base address of the board. It is important that this entry corresponds to the DIP-switch settings on the board. For example, if the base address is 300 (hexadecimal), enter

0x300

## DT2821 Digital Input

DT2821 series boards have two I/O ports, each containing 8 digital I/O lines. These ports can be configured independently for either input or output. Use a separate driver block for each port. By selecting the digital input driver block for a given port, that port is configured for input.

### Scaling of Input to Output

| Hardware Input | Block Output Data Type | Scaling                         |
|----------------|------------------------|---------------------------------|
| TTL            | Double                 | TTL low = 0.0<br>TTL high = 1.0 |

### Driver Block Parameters

**Port** — From the list, choose 1 or 2.

**Channel vector** — Enter numbers between 1 and 8 to select the digital input lines you use with this port. This driver allows the selection of individual digital input lines in any order. The number of elements defines the number of digital lines you use.

For example, to use all of the digital inputs for this port, enter

[1,2,3,4,5,6,7,8]

Number the lines beginning with 1 even if the board manufacturer starts numbering the lines with 0.

**Sample time** — Enter a base sample time or a multiple of the base sample time.

**Base address** — Enter the base address of the board. This entry must correspond to the DIP-switch settings on the board. For example, if the base address is 300 (hexadecimal), enter

0x300

## DT2821 Digital Output

DT2821 series boards have two I/O ports, each containing 8 digital I/O lines. These ports can be configured independently for either input or output. Use a separate driver block for each port. By selecting the digital output driver block for a given port, that port is configured for output.

### Scaling of Input to Output

| Hardware Output | Block Input Data Type | Scaling                           |
|-----------------|-----------------------|-----------------------------------|
| TTL             | Double                | <0.5 = TTL low<br>≥0.5 = TTL high |

### Driver Block Parameters

**Port** — From the list, choose 1 or 2.

**Channel vector** — Enter numbers between 1 and 8. This driver allows the selection of individual digital output lines in any order. The number of elements defines the number of digital lines you use.

For example, to use all of the digital outputs for this port, enter

[ 1,2,3,4,5,6,7,8 ]

Number the lines beginning with 1 even if the board manufacturer starts numbering the lines with 0.

**Sample time** — Enter a base sample time or a multiple of the base sample time.

**Base address** — Enter the base address of the board. This entry must correspond to the DIP-switch settings on the board. For example, if the base address is 300 (hexadecimal), enter

0x300

## DT2821-F-8DI

The DT2821-F-8DI is an I/O board with 8 differential analog input (A/D) channels (12-bit) with a maximum sample rate of 150 kHz, 2 analog output (D/A) channels (12-bit), and 16 digital I/O lines that can be configured in groups of 8 for either input or output.

xPC Target supports this board with these driver blocks:

- “DT2821-F-8DI Analog Input (A/D)” on page 16-8
- “DT2821-F-8DI Analog Output (D/A)” on page 16-10
- “DT2821-F-8DI Digital Input” on page 16-11
- “DT2821-F-8DI Digital Output” on page 16-12

### Board Characteristics

|                                 |                                 |
|---------------------------------|---------------------------------|
| Board Name                      | DT2821-F-8DI                    |
| Manufacturer                    | Data Translation                |
| Bus Type                        | ISA                             |
| Access Method                   | I/O mapped                      |
| Multiple block instance support | A/D:No, D/A:No, Digital I/O:Yes |
| Multiple board support          | Yes                             |

### DT2821-F-8DI Analog Input (A/D)

#### Scaling of Input to Output

| Hardware Input | Block Output Data Type | Scaling |
|----------------|------------------------|---------|
| volts          | Double                 | 1       |

## Driver Block Parameters

**Channel vector** — Enter numbers between 1 and 8. For example, to use the first and third analog output (A/D) channels, enter

[1,3]

Number the channels beginning with 1 even if the board manufacturer starts to number the channels with 0.

**Gain vector** — Enter 1, 2, 4, or 8 for each of the channels in the **Channel vector** to specify the gain for that channel. The gain vector must be the same length as the **Channel vector**. (If you enter a scalar, it is automatically expanded to channel vector). This driver allows the gain of each channel to be different. The gain is applied prior to sampling the voltage.

For example, if you have an input signal from -1 to +1 volts, and a gain of 8, the signal is amplified -8 to +8 volts. Select a range equal or larger than the amplified voltage. For example, select a range of + - 10V. After the signal voltage is sampled, this block divides by the gain to output the original signal value.

**Range** — From the list, choose either + - 10V (-10 volts to +10 volts), or 0 - 10V (0 volts to +10 volts). This specifies the effective range which is the same for all channels and must correspond with the input range setting on the board.

**Sample time** — Enter the base sample time or a multiple of the base sample time.

**Base address** — Enter the base address of the board. It is important that this entry corresponds to the base address setting on the board. For example, if the base address is 300 (hexadecimal), enter

0x300

## DT2821-F-8DI Analog Output (D/A)

### Scaling of Input to Output

| Hardware Output | Block Input Data Type | Scaling |
|-----------------|-----------------------|---------|
| volts           | Double                | 1       |

### Driver Block Parameter

**Channel vector** — Enter numbers between 1 and 2. This driver allows the selection of individual D/A channels in any order. The number of elements defines the number of D/A channels you use. For example, to use the first and second analog output (D/A) channels, enter

[ 1, 2 ]

Number the channels beginning with 1 even if the board manufacturer starts numbering the channels with 0.

**Range vector** — Enter a range code for each of the channels in the **Channel vector**. The range vector must be the same length as the **Channel vector**. This board allows the range of each channel to be different.

The following table is a list of the ranges for this driver and the corresponding range codes.

| Input Range (V) | Range Code | Input Range (V) | Range Code |
|-----------------|------------|-----------------|------------|
| -10 to +10      | -10        | 0 to +5         | 5          |
| -5 to +5        | -5         | 0 to +10        | 10         |
| -2.5 to +2.5    | -2.5       |                 |            |

For example, if the first channel is -10 to +10 volts, and the second channel is 0 to 5 volts, enter

[ -10, 5 ]

The range settings have to correspond to the Output Range Selection settings on the board for DAC0, and DAC1 (channel 1 and 2 respectively).



**Sample time** — Base sample time of a multiple of the base sample time.

**Base address** — Enter the base address of the board. It is important that this entry corresponds to the DIP-switch settings on the board. For example, if the base address is 300 (hexadecimal), enter

0x300

## DT2821-F-8DI Digital Input

DT2821-F-8DI series boards have two I/O ports, each containing 8 digital I/O lines. These ports can be configured independently for either input or output. Use a separate driver block for each port. By selecting the digital input driver block for a given port, that port is configured for input.

### Scaling of Input to Output

| Hardware Input | Block Output Data Type | Scaling                         |
|----------------|------------------------|---------------------------------|
| TTL            | Double                 | TTL low = 0.0<br>TTL high = 1.0 |

### Driver Block Parameters

**Port** — From the list, choose 1 or 2.

**Channel vector** — Enter numbers between 1 and 8 to select the digital input lines you use with this port. This driver allows the selection of individual digital input lines in any order. The number of elements defines the number of digital lines you use.

For example, to use all of the digital inputs for this port, enter

[1,2,3,4,5,6,7,8]

Number the lines beginning with 1 even if the board manufacturer starts numbering the lines with 0.

**Sample time** — Enter a base sample time or a multiple of the base sample time.

**Base address** — Enter the base address of the board. This entry must correspond to the DIP-switch settings on the board. For example, if the base address is 300 (hexadecimal), enter

0x300

## DT2821-F-8DI Digital Output

DT2821-F-8DI series boards have two I/O ports, each containing 8 digital I/O lines. These ports can be configured independently for either input or output. Use a separate driver block for each port. By selecting the digital output driver block for a given port, that port is configured for output.

### Scaling of Input to Output

| Hardware Output | Block Input Data Type | Scaling                           |
|-----------------|-----------------------|-----------------------------------|
| TTL             | Double                | <0.5 = TTL low<br>≥0.5 = TTL high |

### Driver Block Parameters

**Port** — From the list, choose 1 or 2.

**Channel vector** — Enter numbers between 1 and 8. This driver allows the selection of individual digital output lines in any order. The number of elements defines the number of digital lines you use.

For example, to use all of the digital outputs for this port, enter

[1,2,3,4,5,6,7,8]

Number the lines beginning with 1 even if the board manufacturer starts numbering the lines with 0.

**Sample time** — Enter a base sample time or a multiple of the base sample time.

**Base address** — Enter the base address of the board. This entry must correspond to the DIP-switch settings on the board. For example, if the base address is 300 (hexadecimal), enter

0x300

## DT2821-G-8DI

The DT2821-G-8DI is an I/O board with 8 differential analog input (A/D) channels (12-bit) with a maximum sample rate of 250 kHz, 2 analog output (D/A) channels (12-bit), and 16 digital I/O lines that can be configured in groups of 8 for either input or output.

xPC Target supports this board with these driver blocks:

- “DT2821-G-8DI Analog Input (A/D)” on page 16-13
- “DT2821-G-8DI Analog Output (D/A)” on page 16-15
- “DT2821-G-8DI Digital Input” on page 16-16
- “DT2821-G-8DI Digital Output” on page 16-17

### Board Characteristics

|                                 |                                 |
|---------------------------------|---------------------------------|
| Board Name                      | DT2821-G-8DI                    |
| Manufacturer                    | Data Translation                |
| Bus Type                        | ISA                             |
| Access Method                   | I/O mapped                      |
| Multiple block instance support | A/D:No, D/A:No, Digital I/O:Yes |
| Multiple board support          | Yes                             |

### DT2821-G-8DI Analog Input (A/D)

#### Scaling of Input to Output

| Hardware Input | Block Output Data Type | Scaling |
|----------------|------------------------|---------|
| volts          | Double                 | 1       |

### Driver Block Parameters

**Channel vector** — Enter numbers between 1 and 8. For example, to use the first and third analog output (A/D) channels, enter

[1,3]

Number the channels beginning with 1 even if the board manufacturer starts to number the channels with 0.

**Gain vector** — Enter 1, 2, 4, or 8 for each of the channels in the **Channel vector** to specify the gain for that channel. The gain vector must be the same length as the **Channel vector**. (If you enter a scalar, it is automatically expanded to channel vector). This driver allows the gain of each channel to be different. The gain is applied prior to sampling the voltage.

For example, if you have an input signal from -1 to +1 volts, and a gain of 8, the signal is amplified -8 to +8 volts. Select a range equal or larger than the amplified voltage. For example, select a range of +- 10V. After the signal voltage is sampled, this block divides by the gain to output the original signal value.

**Range** — From the list, choose either +- 10V (-10 volts to +10 volts), +-5V (-5 volts to +5 volts), or 0-10V (0 volts to +10 volts). This specifies the effective range which is the same for all channels and must correspond with the input range setting on the board.

**Sample time** — Enter the base sample time or a multiple of the base sample time.

**Base address** — Enter the base address of the board. It is important that this entry corresponds to the base address setting on the board. For example, if the base address is 300 (hexadecimal), enter

0x300

## DT2821-G-8DI Analog Output (D/A)

### Scaling of Input to Output

| Hardware Output | Block Input Data Type | Scaling |
|-----------------|-----------------------|---------|
| volts           | Double                | 1       |

### Driver Block Parameter

**Channel vector** — Enter numbers between 1 and 2. This driver allows the selection of individual D/A channels in any order. The number of elements defines the number of D/A channels you use. For example, to use the first and second analog output (D/A) channels, enter

[ 1, 2 ]

Number the channels beginning with 1 even if the board manufacturer starts numbering the channels with 0.

**Range** — Enter a range code for each of the channels in the **Channel vector**. The range vector must be the same length as the **Channel vector**. This board allows the range of each channel to be different.

The following table is a list of the ranges for this driver and the corresponding range codes.

| Input range (V) | Range code | Input range (V) | Range code |
|-----------------|------------|-----------------|------------|
| -10 to +10      | -10        | 0 to +5         | 5          |
| -5 to +5        | -5         | 0 to +10        | 10         |
| -2.5 to +2.5    | -2.5       |                 |            |

For example, if the first channel is -10 to +10 volts, and the second channel is 0 to 5 volts, enter

[ -10, 5 ]

The range settings have to correspond to the Output Range Selection settings on the board for DAC0, and DAC1 (channel 1 and 2 respectively).

**Sample time** — Base sample time of a multiple of the base sample time.

**Base address** — Enter the base address of the board. It is important that this entry corresponds to the DIP-switch settings on the board. For example, if the base address is 300 (hexadecimal), enter

0x300

## DT2821-G-8DI Digital Input

DT2821-G-8DI series boards have two I/O ports, each containing 8 digital I/O lines. These ports can be configured independently for either input or output. Use a separate driver block for each port. By selecting the digital input driver block for a given port, that port is configured for input.

### Scaling of Input to Output

| Hardware Input | Block Output Data Type | Scaling                         |
|----------------|------------------------|---------------------------------|
| TTL            | Double                 | TTL low = 0.0<br>TTL high = 1.0 |

### Driver Block Parameters

**Port** — From the list, choose 1 or 2.

**Channel vector** — Enter numbers between 1 and 8 to select the digital input lines you use with this port. This driver allows the selection of individual digital input lines in any order. The number of elements defines the number of digital lines you use.

For example, to use all of the digital inputs for this port, enter

[1,2,3,4,5,6,7,8]

Number the lines beginning with 1 even if the board manufacturer starts numbering the lines with 0.

**Sample time** — Enter a base sample time or a multiple of the base sample time.

**Base address** — Enter the base address of the board. This entry must correspond to the DIP-switch settings on the board. For example, if the base address is 300 (hexadecimal), enter

0x300

## DT2821-G-8DI Digital Output

DT2821-G-8DI series boards have two I/O ports, each containing 8 digital I/O lines. These ports can be configured independently for either input or output. Use a separate driver block for each port. By selecting the digital output driver block for a given port, that port is configured for output.

### Scaling of Input to Output

| Hardware Output | Block Input Data Type | Scaling                           |
|-----------------|-----------------------|-----------------------------------|
| TTL             | Double                | <0.5 = TTL low<br>≥0.5 = TTL high |

### Driver Block Parameters

**Port** — From the list, choose 1 or 2.

**Channel vector** — Enter numbers between 1 and 8. This driver allows the selection of individual digital output lines in any order. The number of elements defines the number of digital lines you use.

For example, to use all of the digital outputs for this port, enter

[ 1,2,3,4,5,6,7,8 ]

Number the lines beginning with 1 even if the board manufacturer starts numbering the lines with 0.

**Sample time** — Enter a base sample time or a multiple of the base sample time.

**Base address** — Enter the base address of the board. This entry must correspond to the DIP-switch settings on the board. For example, if the base address is 300 (hexadecimal), enter

0x300

## DT2821-F-16SE

The DT2821-F-16SE is an I/O board with 16 single-ended analog input (A/D) channels (12-bit) with a maximum sample rate of 150 kHz, 2 analog output (D/A) channels (12-bit), and 16 digital I/O lines that can be configured in groups of 8 for either input or output.

xPC Target supports this board with these driver blocks:

- “DT2821-F-16SE Analog Input (A/D)” on page 16-18
- “DT2821-F-16SE Analog Output (D/A)” on page 16-20
- “DT2821-F-16SE Digital Input” on page 16-21
- “DT2821-F-16SE Digital Output” on page 16-22

### Board Characteristics

|                                 |                                 |
|---------------------------------|---------------------------------|
| Board Name                      | DT2821-F-16SE                   |
| Manufacturer                    | Data Translation                |
| Bus Type                        | ISA                             |
| Access Method                   | I/O mapped                      |
| Multiple block instance support | A/D:No, D/A:No, Digital I/O:Yes |
| Multiple board support          | Yes                             |

### DT2821-F-16SE Analog Input (A/D)

#### Scaling of Input to Output

| Hardware Input | Block Output Data Type | Scaling |
|----------------|------------------------|---------|
| volts          | Double                 | 1       |



## Driver Block Parameters

**Channel vector** — Enter numbers between 1 and 16. For example, to use the first and third analog output (A/D) channels, enter

[1,3]

Number the channels beginning with 1 even if the board manufacturer starts to number the channels with 0.

**Gain vector** — Enter 1, 2, 4, or 8 for each of the channels in the **Channel vector** to specify the gain for that channel. The gain vector must be the same length as the **Channel vector**. (If you enter a scalar, it is automatically expanded to channel vector). This driver allows the gain of each channel to be different. The gain is applied prior to sampling the voltage.

For example, if you have an input signal from -1 to +1 volts, and a gain of 8, the signal is amplified -8 to +8 volts. Select a range equal or larger than the amplified voltage. For example, select a range of + - 10V. After the signal voltage is sampled, this block divides by the gain to output the original signal value.

**Range** — From the list, choose either + - 10V (-10 volts to +10 volts), or 0 - 10V (0 volts to +10 volts). This specifies the effective range which is the same for all channels and must correspond with the input range setting on the board.

**Sample time** — Enter the base sample time or a multiple of the base sample time.

**Base address** — Enter the base address of the board. It is important that this entry corresponds to the base address setting on the board. For example, if the base address is 300 (hexadecimal), enter

0x300

## DT2821-F-16SE Analog Output (D/A)

### Scaling of Input to Output

| Hardware Output | Block Input Data Type | Scaling |
|-----------------|-----------------------|---------|
| volts           | Double                | 1       |

### Driver Block Parameter

**Channel vector** — Enter numbers between 1 and 2. This driver allows the selection of individual D/A channels in any order. The number of elements defines the number of D/A channels you use. For example, to use the first and second analog output (D/A) channels, enter

[ 1, 2]

Number the channels beginning with 1 even if the board manufacturer starts numbering the channels with 0.

**Range vector** — Enter a range code for each of the channels in the **Channel vector**. The range vector must be the same length as the **Channel vector**. This board allows the range of each channel to be different.

The following table is a list of the ranges for this driver and the corresponding range codes.

| Input Range (V) | Range Code | Input Range (V) | Range Code |
|-----------------|------------|-----------------|------------|
| -10 to +10      | -10        | 0 to +5         | 5          |
| -5 to +5        | -5         | 0 to +10        | 10         |
| -2.5 to +2.5    | -2.5       |                 |            |

For example, if the first channel is -10 to +10 volts, and the second channel is 0 to 5 volts, enter

[ -10,5]

The range settings have to correspond to the Output Range Selection settings on the board for DAC0, and DAC1 (channel 1 and 2 respectively).

**Sample time** — Base sample time of a multiple of the base sample time.

**Base address** — Enter the base address of the board. It is important that this entry corresponds to the DIP-switch settings on the board. For example, if the base address is 300 (hexadecimal), enter

0x300

## DT2821-F-16SE Digital Input

DT2821-F-16SE series boards have two I/O ports, each containing 8 digital I/O lines. These ports can be configured independently for either input or output. Use a separate driver block for each port. By selecting the digital input driver block for a given port, that port is configured for input.

### Scaling of Input to Output

| Hardware Input | Block Output Data Type | Scaling                         |
|----------------|------------------------|---------------------------------|
| TTL            | Double                 | TTL low = 0.0<br>TTL high = 1.0 |

### Driver Block Parameters

**Port** — From the list, choose 1 or 2.

**Channel vector** — Enter numbers between 1 and 8 to select the digital input lines you use with this port. This driver allows the selection of individual digital input lines in any order. The number of elements defines the number of digital lines you use.

For example, to use all of the digital inputs for this port, enter

[1,2,3,4,5,6,7,8]

Number the lines beginning with 1 even if the board manufacturer starts numbering the lines with 0.

**Sample time** — Enter a base sample time or a multiple of the base sample time.

**Base address** — Enter the base address of the board. This entry must correspond to the DIP-switch settings on the board. For example, if the base address is 300 (hexadecimal), enter

0x300

## DT2821-F-16SE Digital Output

DT2821-F-16SE series boards have two I/O ports, each containing 8 digital I/O lines. These ports can be configured independently for either input or output. Use a separate driver block for each port. By selecting the digital output driver block for a given port, that port is configured for output.

### Scaling of Input to Output

| Hardware Output | Block Input Data Type | Scaling                           |
|-----------------|-----------------------|-----------------------------------|
| TTL             | Double                | <0.5 = TTL low<br>≥0.5 = TTL high |

### Driver Block Parameters

**Port** — From the list, choose 1 or 2.

**Channel vector** — Enter numbers between 1 and 8. This driver allows the selection of individual digital output lines in any order. The number of elements defines the number of digital lines you use.

For example, to use all of the digital outputs for this port, enter

[1,2,3,4,5,6,7,8]

Number the lines beginning with 1 even if the board manufacturer starts numbering the lines with 0.

**Sample time** — Enter a base sample time or a multiple of the base sample time.

**Base address** — Enter the base address of the board. This entry must correspond to the DIP-switch settings on the board. For example, if the base address is 300 (hexadecimal), enter

0x300

## DT2821-G-16SE

The DT2821-G-16SE is an I/O board with 16 single-ended analog input (A/D) channels (12-bit) with a maximum sample rate of 250 kHz, 2 analog output (D/A) channels (12-bit), and 16 digital I/O lines that can be configured in groups of 8 for either input or output.

xPC Target supports this board with these driver blocks:

- “DT2821-G-16SE Analog Input (A/D)” on page 16-23
- “DT2821-G-16SE Analog Output (D/A)” on page 16-25
- “DT2821-G-16SE Digital Input” on page 16-26
- “DT2821-G-16SE Digital Output” on page 16-27

### Board Characteristics

|                                 |                                 |
|---------------------------------|---------------------------------|
| Board Name                      | DT2821-G-16SE                   |
| Manufacturer                    | Data Translation                |
| Bus Type                        | ISA                             |
| Access Method                   | I/O mapped                      |
| Multiple block instance support | A/D:No, D/A:No, Digital I/O:Yes |
| Multiple board support          | Yes                             |

### DT2821-G-16SE Analog Input (A/D)

#### Scaling of Input to Output

| Hardware Input | Block Output Data Type | Scaling |
|----------------|------------------------|---------|
| volts          | Double                 | 1       |

### Driver Block Parameters

**Channel vector** — Enter numbers between 1 and 16. For example, to use the first and third analog output (A/D) channels, enter

[1,3]

Number the channels beginning with 1 even if the board manufacturer starts to number the channels with 0.

**Gain vector** — Enter 1, 2, 4, or 8 for each of the channels in the **Channel vector** to specify the gain for that channel. The gain vector must be the same length as the **Channel vector**. (If you enter a scalar, it is automatically expanded to channel vector). This driver allows the gain of each channel to be different. The gain is applied prior to sampling the voltage.

For example, if you have an input signal from -1 to +1 volts, and a gain of 8, the signal is amplified -8 to +8 volts. Select a range equal or larger than the amplified voltage. For example, select a range of **+10V**. After the signal voltage is sampled, this block divides by the gain to output the original signal value.

**Range** — From the list, choose either +-10V (-10 volts to +10 volts), +-5V (-5 volts to +5 volts), or 0-10V (0 volts to +10 volts). This specifies the effective range which is the same for all channels and must correspond with the input range setting on the board.

**Sample time** — Enter the base sample time or a multiple of the base sample time.

**Base address** — Enter the base address of the board. It is important that this entry corresponds to the base address setting on the board. For example, if the base address is 300 (hexadecimal), enter

0x300

## DT2821-G-16SE Analog Output (D/A)

### Scaling of Input to Output

| Hardware Output | Block Input Data Type | Scaling |
|-----------------|-----------------------|---------|
| volts           | Double                | 1       |

### Driver Block Parameter

**Channel vector** — Enter numbers between 1 and 2. This driver allows the selection of individual D/A channels in any order. The number of elements defines the number of D/A channels you use. For example, to use the first and second analog output (D/A) channels, enter

[ 1, 2]

Number the channels beginning with 1 even if the board manufacturer starts numbering the channels with 0.

**Range vector** — Enter a range code for each of the channels in the **Channel vector**. The range vector must be the same length as the **Channel vector**. This board allows the range of each channel to be different.

The following table is a list of the ranges for this driver and the corresponding range codes.

| Input Range (V) | Range Code | Input Range (V) | Range Code |
|-----------------|------------|-----------------|------------|
| -10 to +10      | -10        | 0 to +5         | 5          |
| -5 to +5        | -5         | 0 to +10        | 10         |
| -2.5 to +2.5    | -2.5       |                 |            |

For example, if the first channel is -10 to +10 volts, and the second channel is 0 to 5 volts, enter

[ -10, 5]

The range settings have to correspond to the Output Range Selection settings on the board for DAC0, and DAC1 (channel 1 and 2 respectively).

**Sample time** — Base sample time of a multiple of the base sample time.

**Base address** — Enter the base address of the board. It is important that this entry corresponds to the DIP-switch settings on the board. For example, if the base address is 300 (hexadecimal), enter

0x300

## DT2821-G-16SE Digital Input

DT2821-G-16SE series boards have two I/O ports, each containing 8 digital I/O lines. These ports can be configured independently for either input or output. Use a separate driver block for each port. By selecting the digital input driver block for a given port, that port is configured for input.

### Scaling of Input to Output

| Hardware Input | Block Output Data Type | Scaling                         |
|----------------|------------------------|---------------------------------|
| TTL            | Double                 | TTL low = 0.0<br>TTL high = 1.0 |

### Driver Block Parameters

**Port** — From the list, choose 1 or 2.

**Channel vector** — Enter numbers between 1 and 8 to select the digital input lines you use with this port. This driver allows the selection of individual digital input lines in any order. The number of elements defines the number of digital lines you use.

For example, to use all of the digital inputs for this port, enter

[1,2,3,4,5,6,7,8]

Number the lines beginning with 1 even if the board manufacturer starts numbering the lines with 0.

**Sample time** — Enter a base sample time or a multiple of the base sample time.



**Base address** — Enter the base address of the board. This entry must correspond to the DIP-switch settings on the board. For example, if the base address is 300 (hexadecimal), enter

0x300

## DT2821-G-16SE Digital Output

DT2821-G-16SE series boards have two I/O ports, each containing 8 digital I/O lines. These ports can be configured independently for either input or output. Use a separate driver block for each port. By selecting the digital output driver block for a given port, that port is configured for output.

### Scaling of Input to Output

| Hardware Output | Block Input Data Type | Scaling                           |
|-----------------|-----------------------|-----------------------------------|
| TTL             | Double                | <0.5 = TTL low<br>≥0.5 = TTL high |

### Driver Block Parameters

**Port** — From the list, choose 1 or 2.

**Channel vector** — Enter numbers between 1 and 8. This driver allows the selection of individual digital output lines in any order. The number of elements defines the number of digital lines you use.

For example, to use all of the digital outputs for this port, enter

[ 1,2,3,4,5,6,7,8 ]

Number the lines beginning with 1 even if the board manufacturer starts numbering the lines with 0.

**Sample time** — Enter a base sample time or a multiple of the base sample time.

**Base address** — Enter the base address of the board. This entry must correspond to the DIP-switch settings on the board. For example, if the base address is 300 (hexadecimal), enter

0x300

## DT2823

The DT2823 is an I/O board 4 differential analog input (A/D) channels (16-bit) with a maximum sample rate of 100 kHz, 2 analog output (D/A) channels (16-bit), and 16 digital I/O lines that can be configured in groups of 8 for either input or output.

xPC Target supports this board with these driver blocks:

- “DT2823 Analog Input (A/D)” on page 16-28
- “DT2823 Analog Output (D/A)” on page 16-29
- “DT2823 Digital Input” on page 16-30
- “DT2823 Digital Output” on page 16-31

### Board Characteristics

|                                 |                                 |
|---------------------------------|---------------------------------|
| Board Name                      | DT2823                          |
| Manufacturer                    | Data Translation                |
| Bus Type                        | ISA                             |
| Access Method                   | I/O mapped                      |
| Multiple block instance support | A/D:No, D/A:No, Digital I/O:Yes |
| Multiple board support          | Yes                             |

### DT2823 Analog Input (A/D)

The range for the DT2823 is -10 to + 10 volts.

### Scaling of Input to Output

| Hardware Input | Block Output Data Type | Scaling |
|----------------|------------------------|---------|
| volts          | Double                 | 1       |

### Driver Block Parameters

**Channel vector** — Enter numbers between 1 and 4. For example, to use the first and third analog output (A/D) channels, enter

[ 1, 3 ]

Number the channels beginning with 1 even if the board manufacturer starts to number the channels with 0.

**Sample time** — Enter the base sample time or a multiple of the base sample time.

**Base address** — Enter the base address of the board. It is important that this entry corresponds to the base address setting on the board. For example, if the base address is 300 (hexadecimal), enter

0x300

## DT2823 Analog Output (D/A)

The range of the DT2823 is -10 to +10 volts.

### Scaling of Input to Output

| Hardware Output | Block Input Data Type | Scaling |
|-----------------|-----------------------|---------|
| volts           | Double                | 1       |

### Driver Block Parameter

**Channel vector** — Enter numbers between 1 and 2. This driver allows the selection of individual D/A channels in any order. The number of elements defines the number of D/A channels you use. For example, to use the first and second analog output (D/A) channels, enter

[ 1, 2 ]

Number the channels beginning with 1 even if the board manufacturer starts numbering the channels with 0.

**Range vector** — Enter a range code for each of the channels in the **Channel vector**. The range vector must be the same length as the **Channel vector**. This board allows the range of each channel to be different.

The following table is a list of the ranges for this driver and the corresponding range codes.

| Input Range (V) | Range Code | Input Range (V) | Range Code |
|-----------------|------------|-----------------|------------|
| -10 to +10      | -10        | 0 to +5         | 5          |
| -5 to +5        | -5         | 0 to +10        | 10         |
| -2.5 to +2.5    | -2.5       |                 |            |

For example, if the first channel is -10 to +10 volts, and the second channel is 0 to 5 volts, enter

[ -10,5]

The range settings have to correspond to the Output Range Selection settings on the board for DAC0, and DAC1 (channel 1 and 2 respectively).

**Sample time** — Base sample time of a multiple of the base sample time.

**Base address** — Enter the base address of the board. It is important that this entry corresponds to the DIP-switch settings on the board. For example, if the base address is 300 (hexadecimal), enter

0x300

## DT2823 Digital Input

DT2823 series boards have two I/O ports, each containing 8 digital I/O lines. These ports can be configured independently for either input or output. Use a separate driver block for each port. By selecting the digital input driver block for a given port, that port is configured for input.

## Scaling of Input to Output

| Hardware Input | Block Output Data Type | Scaling                         |
|----------------|------------------------|---------------------------------|
| TTL            | Double                 | TTL low = 0.0<br>TTL high = 1.0 |

### Driver Block Parameters

**Port** — From the list, choose 1 or 2.

**Channel vector** — Enter numbers between 1 and 8 to select the digital input lines you use with this port. This driver allows the selection of individual digital input lines in any order. The number of elements defines the number of digital lines you use.

For example, to use all of the digital inputs for this port, enter

[1,2,3,4,5,6,7,8]

Number the lines beginning with 1 even if the board manufacturer starts numbering the lines with 0.

**Sample time** — Enter a base sample time or a multiple of the base sample time.

**Base address** — Enter the base address of the board. This entry must correspond to the DIP-switch settings on the board. For example, if the base address is 300 (hexadecimal), enter

0x300

## DT2823 Digital Output

DT2823 series boards have two I/O ports, each containing 8 digital I/O lines. These ports can be configured independently for either input or output. Use a separate driver block for each port. By selecting the digital output driver block for a given port, that port is configured for output.

## Scaling of Input to Output

| Hardware Output | Block Input Data Type | Scaling                           |
|-----------------|-----------------------|-----------------------------------|
| TTL             | Double                | <0.5 = TTL low<br>≥0.5 = TTL high |

### Driver Block Parameters

**Port** — From the list, choose 1 or 2.

**Channel vector** — Enter numbers between 1 and 8. This driver allows the selection of individual digital output lines in any order. The number of elements defines the number of digital lines you use.

For example, to use all of the digital outputs for this port, enter

[1,2,3,4,5,6,7,8]

Number the lines beginning with 1 even if the board manufacturer starts numbering the lines with 0.

**Sample time** — Enter a base sample time or a multiple of the base sample time.

**Base address** — Enter the base address of the board. This entry must corresponds to the DIP-switch settings on the board. For example, if the base address is 300 (hexadecimal), enter

0x300

## DT2824-PGH

The DT2824-PGH is an I/O board with 16 single-ended or 8 differential analog input (A/D) channels (12-bit) with a maximum sample rate of 50 kHz, 2 analog output (D/A) channels (12-bit), and 16 digital I/O lines that can be configured in groups of 8 for either input or output.

xPC Target supports this board with these driver blocks:

- “DT2824-PGH Analog Input (A/D)” on page 16-33
- “DT2824-PGH Digital Input” on page 16-35
- “DT2824-PGL Digital Output” on page 16-40

### Board Characteristics

|                                 |                                 |
|---------------------------------|---------------------------------|
| Board Name                      | DT2824-PGH                      |
| Manufacturer                    | Data Translation                |
| Bus Type                        | ISA                             |
| Access Method                   | I/O mapped                      |
| Multiple block instance support | A/D:No, D/A:No, Digital I/O:Yes |
| Multiple board support          | Yes                             |

### DT2824-PGH Analog Input (A/D)

#### Scaling of Input to Output

| Hardware Input | Block Output Data Type | Scaling |
|----------------|------------------------|---------|
| volts          | Double                 | 1       |

### Driver Block Parameters

**Channel vector** — If you choose Single-ended (16 channels) from the **Input coupling** list, enter numbers between 1 and 16. If you choose Differential (8 channels) from the **Input coupling** list, then enter numbers between 1 and 8. For example, to use the first and third analog output (A/D) channels, enter

[1,3]

Number the channels beginning with 1 even if the board manufacturer starts to number the channels with 0.

**Gain vector** — Enter 1, 2, 4, or 8 for each of the channels in the **Channel vector** to specify the gain for that channel. The gain vector must be the same length as the **Channel vector**. (If you enter a scalar, it is automatically expanded to channel vector). This driver allows the gain of each channel to be different. The gain is applied prior to sampling the voltage.

For example, if you have an input signal from -1 to +1 volts, and a gain of 8, the signal is amplified -8 to +8 volts. Select a range equal or larger than the amplified voltage. For example, select a range of + -10V. After the signal voltage is sampled, this block divides by the gain to output the original signal value.

**Range** — From the list, choose either + -10V (-10 volts to +10 volts), or 0-10V (0 volts to +10 volts). This specifies the effective range which is the same for all channels and must correspond with the input range setting on the board.

**Input coupling** — From the list, select one from the following list of input modes:

- Single-ended channels (16 channels)
- differential channels (8 channels)

This choice must correspond to the input mode setting on the board.

**Sample time** — Enter the base sample time or a multiple of the base sample time.

**Base address** — Enter the base address of the board. It is important that this entry corresponds to the base address setting on the board. For example, if the base address is 300 (hexadecimal), enter

0x300



For example, if the first channel is -10 to +10 volts, and the second channel is 0 to 5 volts, enter

[ -10,5]

## DT2824-PGH Digital Input

DT2824-PGH series boards have two I/O ports, each containing 8 digital I/O lines. These ports can be configured independently for either input or output. Use a separate driver block for each port. By selecting the digital input driver block for a given port, that port is configured for input.

### Scaling of Input to Output

| Hardware Input | Block Output Data Type | Scaling                         |
|----------------|------------------------|---------------------------------|
| TTL            | Double                 | TTL low = 0.0<br>TTL high = 1.0 |

### Driver Block Parameters

**Port** — From the list, choose 1 or 2.

**Channel vector** — Enter numbers between 1 and 8 to select the digital input lines you use with this port. This driver allows the selection of individual digital input lines in any order. The number of elements defines the number of digital lines you use.

For example, to use all of the digital inputs for this port, enter

[ 1,2,3,4,5,6,7,8]

Number the lines beginning with 1 even if the board manufacturer starts numbering the lines with 0.

**Sample time** — Enter a base sample time or a multiple of the base sample time.

**Base address** — Enter the base address of the board. This entry must correspond to the DIP-switch settings on the board. For example, if the base address is 300 (hexadecimal), enter

0x300

## DT2824-PGH Digital Output

DT2824-PGH series boards have two I/O ports, each containing 8 digital I/O lines. These ports can be configured independently for either input or output. Use a separate driver block for each port. By selecting the digital output driver block for a given port, that port is configured for output.

### Scaling of Input to Output

| Hardware Output | Block Input Data Type | Scaling                           |
|-----------------|-----------------------|-----------------------------------|
| TTL             | Double                | <0.5 = TTL low<br>≥0.5 = TTL high |

### Driver Block Parameters

**Port** — From the list, choose 1 or 2.

**Channel vector** — Enter numbers between 1 and 8. This driver allows the selection of individual digital output lines in any order. The number of elements defines the number of digital lines you use.

For example, to use all of the digital outputs for this port, enter

```
[1,2,3,4,5,6,7,8]
```

Number the lines beginning with 1 even if the board manufacturer starts numbering the lines with 0.

**Sample time** — Enter a base sample time or a multiple of the base sample time.

**Base address** — Enter the base address of the board. This entry must correspond to the DIP-switch settings on the board. For example, if the base address is 300 (hexadecimal), enter

```
0x300
```

## DT2824-PGL

The DT2824-PGL is an I/O board with 16 single-ended or 8 differential analog input (A/D) channels (12-bit) with a maximum sample rate of 50 kHz, 2 analog output (D/A) channels (12-bit), and 16 digital I/O lines that can be configured in groups of 8 for either input or output.

xPC Target supports this board with these driver blocks:

- “DT2824-PGL Analog Input (A/D)” on page 16-37
- “DT2824-PGL Digital Input” on page 16-39
- “DT2824-PGL Digital Output” on page 16-40

### Board Characteristics

|                                 |                                 |
|---------------------------------|---------------------------------|
| Board Name                      | DT2824-PGL                      |
| Manufacturer                    | Data Translation                |
| Bus Type                        | ISA                             |
| Access Method                   | I/O mapped                      |
| Multiple block instance support | A/D:No, D/A:No, Digital I/O:Yes |
| Multiple board support          | Yes                             |

### DT2824-PGL Analog Input (A/D)

#### Scaling of Input to Output

| Hardware Input | Block Output Data Type | Scaling |
|----------------|------------------------|---------|
| volts          | Double                 | 1       |

### Driver Block Parameters

**Channel vector** — If you choose Single-ended (16 channels) from the **Input coupling** list, enter numbers between 1 and 16. If you choose Differential (8 channels) from the **Input coupling** list, then enter numbers between 1 and 8. For example, to use the first and third analog output (A/D) channels, enter

[1,3]

Number the channels beginning with 1 even if the board manufacturer starts to number the channels with 0.

**Gain vector** — Enter 1, 10, 100, or 500 for each of the channels in the **Channel vector** to specify the gain for that channel. The gain vector must be the same length as the **Channel vector**. (If you enter a scalar, it is automatically expanded to channel vector). This driver allows the gain of each channel to be different. The gain is applied prior to sampling the voltage.

For example, if you have an input signal from -1 to +1 volts, and a gain of 8, the signal is amplified -8 to +8 volts. Select a range equal or larger than the amplified voltage. For example, select a range of + -10V. After the signal voltage is sampled, this block divides by the gain to output the original signal value.

**Range** — From the list, choose either + -10V (-10 volts to +10 volts), or 0-10V (0 volts to +10 volts). This specifies the effective range which is the same for all channels and must correspond with the input range setting on the board.

**Input coupling** — From the list, select one from the following list of input modes:

- Single-ended channels (16 channels)
- differential channels (8 channels)

This choice must correspond to the input mode setting on the board.

**Sample time** — Enter the base sample time or a multiple of the base sample time.

**Base address** — Enter the base address of the board. It is important that this entry corresponds to the base address setting on the board. For example, if the base address is 300 (hexadecimal), enter

0x300

For example, if the first channel is -10 to +10 volts, and the second channel is 0 to 5 volts, enter

[ -10,5]

## DT2824-PGL Digital Input

DT2824-PGL series boards have two I/O ports, each containing 8 digital I/O lines. These ports can be configured independently for either input or output. Use a separate driver block for each port. By selecting the digital input driver block for a given port, that port is configured for input.

### Scaling of Input to Output

| Hardware Input | Block Output Data Type | Scaling                         |
|----------------|------------------------|---------------------------------|
| TTL            | Double                 | TTL low = 0.0<br>TTL high = 1.0 |

### Driver Block Parameters

**Port** — From the list, choose 1 or 2.

**Channel vector** — Enter numbers between 1 and 8 to select the digital input lines you use with this port. This driver allows the selection of individual digital input lines in any order. The number of elements defines the number of digital lines you use.

For example, to use all of the digital inputs for this port, enter

[ 1,2,3,4,5,6,7,8]

Number the lines beginning with 1 even if the board manufacturer starts numbering the lines with 0.

**Sample time** — Enter a base sample time or a multiple of the base sample time.

**Base address** — Enter the base address of the board. This entry must correspond to the DIP-switch settings on the board. For example, if the base address is 300 (hexadecimal), enter

0x300

## DT2824-PGL Digital Output

DT2824-PGL series boards have two I/O ports, each containing 8 digital I/O lines. These ports can be configured independently for either input or output. Use a separate driver block for each port. By selecting the digital output driver block for a given port, that port is configured for output.

### Scaling of Input to Output

| Hardware Output | Block Input Data Type | Scaling                           |
|-----------------|-----------------------|-----------------------------------|
| TTL             | Double                | <0.5 = TTL low<br>≥0.5 = TTL high |

### Driver Block Parameters

**Port** — From the list, choose 1 or 2.

**Channel vector** — Enter numbers between 1 and 8. This driver allows the selection of individual digital output lines in any order. The number of elements defines the number of digital lines you use.

For example, to use all of the digital outputs for this port, enter

```
[1,2,3,4,5,6,7,8]
```

Number the lines beginning with 1 even if the board manufacturer starts numbering the lines with 0.

**Sample time** — Enter a base sample time or a multiple of the base sample time.

**Base address** — Enter the base address of the board. This entry must correspond to the DIP-switch settings on the board. For example, if the base address is 300 (hexadecimal), enter

```
0x300
```

## DT2825

The DT2825 is an I/O board with 16 single-ended or 8 differential analog input (A/D) channels (12-bit) with a maximum sample rate of 45 kHz, 2 analog output (D/A) channels (12-bit), and 16 digital I/O lines that can be configured in groups of 8 for either input or output.

xPC Target supports this board with these driver blocks:

- “DT2825 Analog Input (A/D)” on page 16-41
- “DT2825 Analog Output (D/A)” on page 16-43
- “DT2825 Digital Input” on page 16-44
- “DT2825 Digital Output” on page 16-45

### Board Characteristics

|                                 |                                 |
|---------------------------------|---------------------------------|
| Board Name                      | DT2825                          |
| Manufacturer                    | Data Translation                |
| Bus Type                        | ISA                             |
| Access Method                   | I/O mapped                      |
| Multiple block instance support | A/D:No, D/A:No, Digital I/O:Yes |
| Multiple board support          | Yes                             |

### DT2825 Analog Input (A/D)

#### Scaling of Input to Output

| Hardware Input | Block Output Data Type | Scaling |
|----------------|------------------------|---------|
| volts          | Double                 | 1       |

### Driver Block Parameters

**Channel vector** — If you choose Single-ended (16 channels) from the **Input coupling** list, enter numbers between 1 and 16. If you choose Differential (8 channels) from the **Input coupling** list, then enter numbers between 1 and 8. For example, to use the first and third analog output (A/D) channels, enter

[1,3]

Number the channels beginning with 1 even if the board manufacturer starts to number the channels with 0.

**Gain vector** — Enter 1, 10, 100, or 500 for each of the channels in the **Channel vector** to specify the gain for that channel. The gain vector must be the same length as the **Channel vector**. (If you enter a scalar, it is automatically expanded to channel vector). This driver allows the gain of each channel to be different. The gain is applied prior to sampling the voltage.

For example, if you have an input signal from -1 to +1 volts, and a gain of 8, the signal is amplified -8 to +8 volts. Select a range equal or larger than the amplified voltage. For example, select a range of + - 10V. After the signal voltage is sampled, this block divides by the gain to output the original signal value.

**Range** — From the list, choose either + - 10V (-10 volts to +10 volts), or 0 - 10V (0 volts to +10 volts). This specifies the effective range which is the same for all channels and must correspond with the input range setting on the board.

**Input coupling** — From the list, choose one of the input modes:

- Single-ended channels (16 channels)
- differential channels (8 channels)

This choice must correspond to the input mode setting on the board.

**Sample time** — Enter the base sample time or a multiple of the base sample time.

**Base address** — Enter the base address of the board. It is important that this entry corresponds to the base address setting on the board. For example, if the base address is 300 (hexadecimal), enter

0x300



## DT2825 Analog Output (D/A)

### Scaling of Input to Output

| Hardware Output | Block Input Data Type | Scaling |
|-----------------|-----------------------|---------|
| volts           | Double                | 1       |

### Driver Block Parameter

**Channel vector** — Enter numbers between 1 and 2. This driver allows the selection of individual D/A channels in any order. The number of elements defines the number of D/A channels you use. For example, to use the first and second analog output (D/A) channels, enter

[ 1, 2 ]

Number the channels beginning with 1 even if the board manufacturer starts numbering the channels with 0.

**Range vector** — Enter a range code for each of the channels in the **Channel vector**. The range vector must be the same length as the **Channel vector**. This board allows the range of each channel to be different.

The following table is a list of the ranges for this driver and the corresponding range codes.

| Input Range (V) | Range Code | Input Range (V) | Range Code |
|-----------------|------------|-----------------|------------|
| -10 to +10      | -10        | 0 to +5         | 5          |
| -5 to +5        | -5         | 0 to +10        | 10         |
| -2.5 to +2.5    | -2.5       |                 |            |

For example, if the first channel is -10 to +10 volts, and the second channel is 0 to 5 volts, enter

[ -10, 5 ]

The range settings have to correspond to the Output Range Selection settings on the board for DAC0, and DAC1 (channel 1 and 2 respectively).

**Sample time** — Base sample time of a multiple of the base sample time.

**Base address** — Enter the base address of the board. It is important that this entry corresponds to the DIP-switch settings on the board. For example, if the base address is 300 (hexadecimal), enter

0x300

## DT2825 Digital Input

DT2825 series boards have two I/O ports, each containing 8 digital I/O lines. These ports can be configured independently for either input or output. Use a separate driver block for each port. By selecting the digital input driver block for a given port, that port is configured for input.

### Scaling of Input to Output

| Hardware Input | Block Output Data Type | Scaling                         |
|----------------|------------------------|---------------------------------|
| TTL            | Double                 | TTL low = 0.0<br>TTL high = 1.0 |

### Driver Block Parameters

**Port** — From the list, choose 1 or 2.

**Channel vector** — Enter numbers between 1 and 8 to select the digital input lines you use with this port. This driver allows the selection of individual digital input lines in any order. The number of elements defines the number of digital lines you use.

For example, to use all of the digital inputs for this port, enter

[1,2,3,4,5,6,7,8]

Number the lines beginning with 1 even if the board manufacturer starts numbering the lines with 0.

**Sample time** — Enter a base sample time or a multiple of the base sample time.

**Base address** — Enter the base address of the board. This entry must correspond to the DIP-switch settings on the board. For example, if the base address is 300 (hexadecimal), enter

0x300

## DT2825 Digital Output

DT2825 series boards have two I/O ports, each containing 8 digital I/O lines. These ports can be configured independently for either input or output. Use a separate driver block for each port. By selecting the digital output driver block for a given port, that port is configured for output.

### Scaling of Input to Output

| Hardware Output | Block Input Data Type | Scaling                           |
|-----------------|-----------------------|-----------------------------------|
| TTL             | Double                | <0.5 = TTL low<br>≥0.5 = TTL high |

### Driver Block Parameters

**Port** — From the list, choose 1 or 2.

**Channel vector** — Enter numbers between 1 and 8. This driver allows the selection of individual digital output lines in any order. The number of elements defines the number of digital lines you use.

For example, to use all of the digital outputs for this port, enter

[ 1,2,3,4,5,6,7,8 ]

Number the lines beginning with 1 even if the board manufacturer starts numbering the lines with 0.

**Sample time** — Enter a base sample time or a multiple of the base sample time.

**Base address** — Enter the base address of the board. This entry must correspond to the DIP-switch settings on the board. For example, if the base address is 300 (hexadecimal), enter

0x300

## DT2827

The DT2827 is an I/O board with 4 differential analog input (A/D) channels (16-bit) with a maximum sample rate of 100kHz, 2 analog output (D/A) channels (12-bit), and 16 digital I/O lines that can be configured in groups of 8 for either input or output.

xPC Target supports this board with these driver blocks:

- “DT2827 Analog Input (A/D)” on page 16-46
- “DT2827 Analog Output (D/A)” on page 16-47
- “DT2827 Digital Input” on page 16-48
- “DT2827 Digital Output” on page 16-49

### Board Characteristics

|                                 |                                 |
|---------------------------------|---------------------------------|
| Board Name                      | DT2827                          |
| Manufacturer                    | Data Translation                |
| Bus Type                        | ISA                             |
| Access Method                   | I/O mapped                      |
| Multiple block instance support | A/D:No, D/A:No, Digital I/O:Yes |
| Multiple board support          | Yes                             |

### DT2827 Analog Input (A/D)

The range for this board is -10 to +10 volts.

### Scaling of Input to Output

| Hardware Input | Block Output Data Type | Scaling |
|----------------|------------------------|---------|
| volts          | Double                 | 1       |

### Driver Block Parameters

**Channel vector** — Enter numbers between 1 and 4. For example, to use the first and third analog output (A/D) channels, enter

[ 1, 3 ]

Number the channels beginning with 1 even if the board manufacturer starts to number the channels with 0.

**Sample time** — Enter the base sample time or a multiple of the base sample time.

**Base address** — Enter the base address of the board. It is important that this entry corresponds to the base address setting on the board. For example, if the base address is 300 (hexadecimal), enter

0x300

## DT2827 Analog Output (D/A)

The range for this board is -10 to + 10 volts.

### Scaling of Input to Output

| Hardware Output | Block Input Data Type | Scaling |
|-----------------|-----------------------|---------|
| volts           | Double                | 1       |

### Driver Block Parameter

**Channel vector** — Enter numbers between 1 and 2. This driver allows the selection of individual D/A channels in any order. The number of elements defines the number of D/A channels you use. For example, to use the first and second analog output (D/A) channels, enter

[ 1, 2 ]

Number the channels beginning with 1 even if the board manufacturer starts numbering the channels with 0.

**Range vector** — Enter a range code for each of the channels in the **Channel vector**. The range vector must be the same length as the **Channel vector**. This board allows the range of each channel to be different.

The following table is a list of the ranges for this driver and the corresponding range codes.

| Input Range (V) | Range Code | Input Range (V) | Range Code |
|-----------------|------------|-----------------|------------|
| -10 to +10      | -10        | 0 to +5         | 5          |
| -5 to +5        | -5         | 0 to +10        | 10         |
| -2.5 to +2.5    | -2.5       |                 |            |

For example, if the first channel is -10 to +10 volts, and the second channel is 0 to 5 volts, enter

[ -10,5]

The range settings have to correspond to the Output Range Selection settings on the board for DAC0, and DAC1 (channel 1 and 2 respectively).

**Sample time** — Base sample time of a multiple of the base sample time.

**Base address** — Enter the base address of the board. It is important that this entry corresponds to the DIP-switch settings on the board. For example, if the base address is 300 (hexadecimal), enter

0x300

## DT2827 Digital Input

DT2827 series boards have two I/O ports, each containing 8 digital I/O lines. These ports can be configured independently for either input or output. Use a separate driver block for each port. By selecting the digital input driver block for a given port, that port is configured for input.

## Scaling of Input to Output

| Hardware Input | Block Output Data Type | Scaling                         |
|----------------|------------------------|---------------------------------|
| TTL            | Double                 | TTL low = 0.0<br>TTL high = 1.0 |

### Driver Block Parameters

**Port** — From the list, choose 1 or 2.

**Channel vector** — Enter numbers between 1 and 8 to select the digital input lines you use with this port. This driver allows the selection of individual digital input lines in any order. The number of elements defines the number of digital lines you use.

For example, to use all of the digital inputs for this port, enter

[1,2,3,4,5,6,7,8]

Number the lines beginning with 1 even if the board manufacturer starts numbering the lines with 0.

**Sample time** — Enter a base sample time or a multiple of the base sample time.

**Base address** — Enter the base address of the board. This entry must correspond to the DIP-switch settings on the board. For example, if the base address is 300 (hexadecimal), enter

0x300

## DT2827 Digital Output

DT2827 series boards have two I/O ports, each containing 8 digital I/O lines. These ports can be configured independently for either input or output. Use a separate driver block for each port. By selecting the digital output driver block for a given port, that port is configured for output.

## Scaling of Input to Output

| Hardware Output | Block Input Data Type | Scaling                           |
|-----------------|-----------------------|-----------------------------------|
| TTL             | Double                | <0.5 = TTL low<br>≥0.5 = TTL high |

### Driver Block Parameters

**Port** — From the list, choose 1 or 2.

**Channel vector** — Enter numbers between 1 and 8. This driver allows the selection of individual digital output lines in any order. The number of elements defines the number of digital lines you use.

For example, to use all of the digital outputs for this port, enter

[1,2,3,4,5,6,7,8]

Number the lines beginning with 1 even if the board manufacturer starts numbering the lines with 0.

**Sample time** — Enter a base sample time or a multiple of the base sample time.

**Base address** — Enter the base address of the board. This entry must correspond to the DIP-switch settings on the board. For example, if the base address is 300 (hexadecimal), enter

0x300



## DT2828

The DT2828 is an I/O board with 4 single-ended analog input (A/D) channels (12-bit) with a maximum sample rate of 100 kHz, 2 analog output (D/A) channels (12-bit), and 16 digital I/O lines that can be configured in groups of 8 for either input or output.

xPC Target supports this board with these driver blocks:

- “DT2828 Analog Input (A/D)” on page 16-51
- “DT2828 Analog Output (D/A)” on page 16-53
- “DT2828 Digital Input” on page 16-54
- “DT2828 Digital Output” on page 16-55

### Board Characteristics

|                                 |                                 |
|---------------------------------|---------------------------------|
| Board Name                      | DT2828                          |
| Manufacturer                    | Data Translation                |
| Bus Type                        | ISA                             |
| Access Method                   | I/O mapped                      |
| Multiple block instance support | A/D:No, D/A:No, Digital I/O:Yes |
| Multiple board support          | Yes                             |

### DT2828 Analog Input (A/D)

#### Scaling of Input to Output

| Hardware Input | Block Output Data Type | Scaling |
|----------------|------------------------|---------|
| volts          | Double                 | 1       |

### Driver Block Parameters

**Channel vector** — Enter numbers between 1 and 4. For example, to use the first and third analog output (A/D) channels, enter

[1,3]

Number the channels beginning with 1 even if the board manufacturer starts to number the channels with 0.

**Gain vector** — Enter 1, 2, 4, or 8 for each of the channels in the **Channel vector** to specify the gain for that channel. The gain vector must be the same length as the **Channel vector**. (If you enter a scalar, it is automatically expanded to channel vector). This driver allows the gain of each channel to be different. The gain is applied prior to sampling the voltage.

For example, if you have an input signal from -1 to +1 volts, and a gain of 8, the signal is amplified -8 to +8 volts. Select a range equal or larger than the amplified voltage. For example, select a range of **+10V**. After the signal voltage is sampled, this block divides by the gain to output the original signal value.

**Range** — From the list, choose either **+10V** (-10 volts to +10 volts), or **0-10V** (0 volts to +10 volts). This specifies the effective range which is the same for all channels and must correspond with the input range setting on the board.

**Sample time** — Enter the base sample time or a multiple of the base sample time.

**Base address** — Enter the base address of the board. It is important that this entry corresponds to the base address setting on the board. For example, if the base address is 300 (hexadecimal), enter

0x300

## DT2828 Analog Output (D/A)

### Scaling of Input to Output

| Hardware Output | Block Input Data Type | Scaling |
|-----------------|-----------------------|---------|
| volts           | Double                | 1       |

### Driver Block Parameter

**Channel vector** — Enter numbers between 1 and 2. This driver allows the selection of individual D/A channels in any order. The number of elements defines the number of D/A channels you use. For example, to use the first and second analog output (D/A) channels, enter

[ 1, 2 ]

Number the channels beginning with 1 even if the board manufacturer starts numbering the channels with 0.

**Range vector** — Enter a range code for each of the channels in the **Channel vector**. The range vector must be the same length as the **Channel vector**. This board allows the range of each channel to be different.

The following table is a list of the ranges for this driver and the corresponding range codes.

| Input Range (V) | Range Code | Input Range (V) | Range Code |
|-----------------|------------|-----------------|------------|
| -10 to +10      | -10        | 0 to +5         | 5          |
| -5 to +5        | -5         | 0 to +10        | 10         |
| -2.5 to +2.5    | -2.5       |                 |            |

For example, if the first channel is -10 to +10 volts, and the second channel is 0 to 5 volts, enter

[ -10, 5 ]

The range settings have to correspond to the Output Range Selection settings on the board for DAC0, and DAC1 (channel 1 and 2 respectively).

**Sample time** — Base sample time of a multiple of the base sample time.

**Base address** — Enter the base address of the board. It is important that this entry corresponds to the DIP-switch settings on the board. For example, if the base address is 300 (hexadecimal), enter

0x300

## DT2828 Digital Input

DT2828 series boards have two I/O ports, each containing 8 digital I/O lines. These ports can be configured independently for either input or output. Use a separate driver block for each port. By selecting the digital input driver block for a given port, that port is configured for input.

### Scaling of Input to Output

| Hardware Input | Block Output Data Type | Scaling                         |
|----------------|------------------------|---------------------------------|
| TTL            | Double                 | TTL low = 0.0<br>TTL high = 1.0 |

### Driver Block Parameters

**Port** — From the list, choose 1 or 2.

**Channel vector** — Enter numbers between 1 and 8 to select the digital input lines you use with this port. This driver allows the selection of individual digital input lines in any order. The number of elements defines the number of digital lines you use.

For example, to use all of the digital inputs for this port, enter

[1,2,3,4,5,6,7,8]

Number the lines beginning with 1 even if the board manufacturer starts numbering the lines with 0.

**Sample time** — Enter a base sample time or a multiple of the base sample time.

**Base address** — Enter the base address of the board. This entry must correspond to the DIP-switch settings on the board. For example, if the base address is 300 (hexadecimal), enter

0x300

## DT2828 Digital Output

DT2828 series boards have two I/O ports, each containing 8 digital I/O lines. These ports can be configured independently for either input or output. Use a separate driver block for each port. By selecting the digital output driver block for a given port, that port is configured for output.

### Scaling of Input to Output

| Hardware Output | Block Input Data Type | Scaling                           |
|-----------------|-----------------------|-----------------------------------|
| TTL             | Double                | <0.5 = TTL low<br>≥0.5 = TTL high |

### Driver Block Parameters

**Port** — From the list, choose 1 or 2.

**Channel vector** — Enter numbers between 1 and 8. This driver allows the selection of individual digital output lines in any order. The number of elements defines the number of digital lines you use.

For example, to use all of the digital outputs for this port, enter

[ 1,2,3,4,5,6,7,8 ]

Number the lines beginning with 1 even if the board manufacturer starts numbering the lines with 0.

**Sample time** — Enter a base sample time or a multiple of the base sample time.

**Base address** — Enter the base address of the board. This entry must correspond to the DIP-switch settings on the board. For example, if the base address is 300 (hexadecimal), enter

0x300



# Diamond

---

I/O Boards supported by xPC Target (<http://www.diamondsystems.com>).

|                             |                                                                                                                                                                                                                                          |
|-----------------------------|------------------------------------------------------------------------------------------------------------------------------------------------------------------------------------------------------------------------------------------|
| Diamond-MM (p. 17-3)        | DAS16 compatible I/O board with 16 single or 8 differential analog input (A/D) channels, 2 analog output (D/A) channels, 8 digital input lines, and 8 digital output lines.                                                              |
| Diamond-MM-16-AT (p. 17-9)  | PC104 I/O board with 16 single-ended or 8 differential analog input (A/D) channels (16-bit), 4 optional analog output (D/A) channels (12-bit), 8 digital input and output lines.                                                         |
| Diamond-MM-32-AT (p. 17-15) | PC104 I/O board with 32 single or 16 differential analog input (A/D) channels, 4 analog output (D/A) channels, 24 digital input and output lines.                                                                                        |
| Garnet-MM (p. 17-25)        | I/O board with 24 or 48 high current digital I/O lines that can be configured in groups of eight for either digital input or digital output.                                                                                             |
| Onyx-MM (p. 17-28)          | I/O board with 48 digital I/O lines that can be configured in groups of 8 for either digital input or digital output, counters, and timers.                                                                                              |
| Onyx-MM-DIO (p. 17-31)      | I/O board with 48 digital I/O lines that can be configured in groups of eight for either digital input or digital output.                                                                                                                |
| Prometheus (p. 17-34)       | Intel 486-based embedded PC/104 CPU board with 4 serial ports, 2 USB ports, 1 parallel port, keyboard and mouse ports, floppy and IDE driver connectors, a 100BaseT Ethernet connector, and provision for solid state flashdisk modules. |
| Quartz-MM 5 (p. 17-40)      | 8 digital input lines, 8 digital output lines, and 10 counter/timers.                                                                                                                                                                    |

Quartz-MM 10 (p. 17-52)

8 digital input line, 8 digital output lines, and 10 counter/timers.

Ruby-MM (p. 17-63)

PC104 I/O board with 4 or 8 single analog output (D/A) channels, unipolar and bipolar operation, +/- 10V, +/- 5V, 0-10V, 0-5V fixed ranges, +/- 2.5V, 0-2.5V user-adjustable ranges, 24 digital input and output lines.

Ruby-MM-416 (p. 17-68)

4 16-bit analog output (D/A) channels, and 24 digital I/O lines that can be configured in groups of 8 for either input or output.

Ruby-MM-1612 (p. 17-73)

16 12-bit analog output (D/A) channels, and 24 digital I/O lines which can be configured in groups of 8 for either input or output.



## Diamond-MM

The Diamond-MM is a DAS16 compatible I/O board with 16 single or 8 differential analog input (A/D) channels (12-bit) with a maximum sample rate or 100 kHz, 2 analog output (D/A) channels (12-bit), 8 digital input lines, and 8 digital output lines.

xPC Target supports this board with these driver blocks:

- “MM Analog Input (A/D)” on page 17-3
- “MM Analog Output (D/A)” on page 17-5
- “MM Digital Input” on page 17-7
- “MM Digital Output” on page 17-7

### Board Characteristics

|                                 |                             |
|---------------------------------|-----------------------------|
| Board name                      | Diamond-MM                  |
| Manufacturer                    | Diamond Systems Corporation |
| Bus type                        | ISA (PC/104)                |
| Access method                   | I/O mapped                  |
| Multiple block instance support | No                          |
| Multiple board support          | Yes                         |

### MM Analog Input (A/D)

#### Scaling Input to Output

| Hardware Input | Block Output Data Type | Scaling |
|----------------|------------------------|---------|
| volts          | Double                 | 1       |

### Driver Block Parameters

**Number of channels** — If you select 16 channels (**Coupling** parameter set to 16 single-ended channels) enter a number between 1 and 16 to select the number of single A/D channels used. If you select eight channels (**Coupling** parameter set to 8 differential channels) enter a number between 1 and 8.

Number the lines beginning with 1 even if the board manufacturer starts numbering the lines with 0.

Note, you cannot select the starting channel for this block, you can only select the number of channels. This block works differently from the Diamond-MM-32-AT A/D block, where you can specify the starting channel.

**Range** — Enter an input range code for all A/D channels. This driver does not allow the selection of a different range for each channel. The input range is the same for all A/D channels.

The following table is a list of the ranges for this driver and the corresponding range codes.

| Input Range (V) | Range Code | Input Range (V) | Range Code |
|-----------------|------------|-----------------|------------|
| -10 to +10      | -10        | 0 to +10        | 10         |
| -5 to +5        | -5         | 0 to +5         | 5          |
| -2.5 to + 2.5   | -2.5       | 0 to +2         | 2          |
| -1 to +1        | -1         | 0 to +1         | 1          |
| -0.5 to +0.5    | -5         |                 |            |

The gain jumpers on the board have to be in the correct positions for the chosen range. The bipolar jumper on the board has to be in the bipolar position, if a bipolar range is used or in the unipolar position, when a unipolar range is used.

**Coupling** — From the list, select one from the following list of input modes:

- 16 single-ended channels
- 8 differential channels

This choice must correspond to the jumper setting in block J6 on the board.

**Show error status output (E)** — Select this check box to add a port labeled **E** to the block and to display (the contents of) that special port. This output will always have a value of 0 unless a problem is detected while attempting an A/D conversion. In the unlikely event that an error occurs, the port has a nonzero value. This nonzero value takes the form of a real number whose binary representation of 1's and 0's (true and false) indicates which channels have errors.

**Sample time** — Enter the base sample time or a multiple of the base sample time.

**Base address** — Enter the base address of the board. This entry must correspond to the DIP switch settings on the board. For example, if the base address is 300 (hexadecimal), enter

0x300

## MM Analog Output (D/A)

### Scaling Input to Output

| Hardware Output | Block Input Data Type | Scaling |
|-----------------|-----------------------|---------|
| volts           | Double                | 1       |

### Driver Block Parameters

**Channel vector** — This parameter is a combined Channel vector and Range vector. The number of elements defines the number of D/A channels used.

**Range vector** — Enter a range code for each of the D/A channels used. This driver allows a different range for each channel with a maximum of 2 channels.

The following table is a list of the ranges for this driver and the corresponding range codes. The D/A specific jumpers on the board have to be in the correct positions for the ranges entered.

| Input Range (V) | Range Code |
|-----------------|------------|
| 0 to +10        | 10         |
| 0 to +5         | 5          |

For example, if the first channel is 0 to + 10 volts and the second channel is 0 to +5 volts, enter

[10,5]

**Reset vector** — The reset vector controls the behavior of the channel at model termination. Enter a scalar or a vector that is the same length as the channel vector. If you specify a scalar value, that setting is used for all channels. If you specify a value of 1, the corresponding channel is reset to the value specified in the initial value vector. If you specify a value of 0, the channel remains at the last value attained while the model was running.

**Initial value vector** — The initial value vector contains the initial voltage values for the input channels. Enter a scalar or a vector that is the same length as the channel vector. If you specify a scalar value, that value is the initial value for all channels. The channels are set to the initial values between the time the model is downloaded and the time it is started. If you provide an out-of-range value for a channel, that value is adjusted to lie within the correct range, as defined in the parameter **Range**.

**Sample time** — Enter the base sample time or a multiple of the base sample time.

**Base address** — Enter the base address of the board. This entry must correspond to the DIP switch settings on the board. For example, if the base address is 300 (hexadecimal), enter

0x300

## MM Digital Input

### Scaling Input to Output

| Hardware Input | Block Output Data Type | Scaling                         |
|----------------|------------------------|---------------------------------|
| TTL            | Double                 | TTL low = 0.0<br>TTL high = 1.0 |

### Driver Block Parameters

**Channel vector** — Enter numbers between 1 and 8. This driver allows the selection of individual digital input channels in any order. The number of elements defines the number of digital input channels you use. For example, to use all the digital input channels, enter

[1:8]

Number the channels beginning with 1 even if the board manufacturer starts numbering the channels with 0.

**Sample time** — Enter a base sample time or a multiple of the base sample time.

**Base address** — Enter the base address of the board. This entry must correspond to the DIP switch settings on the board. For example, if the base address is 300 (hexadecimal), enter

0x300

## MM Digital Output

### Scaling Input to Output

| Hardware Output | Block Input Data Type | Scaling                             |
|-----------------|-----------------------|-------------------------------------|
| TTL             | Double                | < 0.5 = TTL low<br>≥ 0.5 = TTL high |

### Driver Block Parameters

**Channel vector** — Enter numbers between 1 and 8. This driver allows the selection of individual digital input channels in any order. The number of elements defines the number of digital input channels you use. For example, to use all the digital output channels, enter

[1:8]

Number the channels beginning with 1 even if the board manufacturer starts numbering the channels with 0.

**Reset vector** — The reset vector controls the behavior of the channel at model termination. Enter a scalar or a vector that is the same length as the channel vector. If you specify a scalar value, that setting is used for all channels. If you specify a value of 1, the corresponding channel is reset to the value specified in the initial value vector. If you specify a value of 0, the channel remains at the last value attained while the model was running.

**Initial value vector** — The initial value vector contains the initial voltage values for the input channels. Enter a scalar or a vector that is the same length as the channel vector. If you specify a scalar value, that value is the initial value for all channels. The channels are set to the initial values between the time the model is downloaded and the time it is started. If you provide an out-of-range value for a channel, that value is adjusted to lie within the correct range, as defined in the parameter **Range**.

**Sample time** — Enter a base sample time or a multiple of the base sample time.

**Base address** — Enter the base address of the board. This entry must correspond to the DIP switch settings on the board. For example, if the base address is 300 (hexadecimal), enter

0x300

## Diamond-MM-16-AT

The Diamond MM-AT is a PC104 I/O board with 16 single-ended or 8 differential analog input (A/D) channels (16-bit), 4 optional analog output (D/A) channels (12-bit), 8 digital input and output lines.

xPC Target supports this board with these driver blocks:

- “MM-16-AT Analog Input (A/D)” on page 17-10
- “MM-16-AT Analog Output (D/A)” on page 17-11
- “MM-16-AT Digital Input” on page 17-12
- “MM-16-AT Digital Output” on page 17-13

xPC Target does not support the counters/timers on this board.

### Board Characteristics

|                                 |                             |
|---------------------------------|-----------------------------|
| Board name                      | Diamond-MM-16-AT            |
| Manufacturer                    | Diamond Systems Corporation |
| Bus type                        | ISA (PC/104)                |
| Access method                   | I/O mapped                  |
| Multiple block instance support | No                          |
| Multiple board support          | Yes                         |

## MM-16-AT Analog Input (A/D)

### Scaling Input to Output

| Hardware Input | Block Output Data Type | Scaling |
|----------------|------------------------|---------|
| volts          | Double                 | 1       |

### Driver Block Parameters

**First Channel** — Enter the number of the first channel in a set of contiguous analog input channels. Depending on the channel configuration selected, the first channel number must lie within the range 1 through 8 (**Coupling** parameter set to 8 differential channels) or 1 through 16 (**Coupling** parameter set to 16 single-ended channels).

Number the lines beginning with 1 even if the board manufacturer starts numbering the lines with 0.

**Number of Channels** — Enter the number of input channels you want to use. The maximum number of channels varies between 1 and 16 and depends on the values of **Coupling** and the **First channel number**.

**Range** — From the list, choose a voltage range. The input range applies to all channels.

**Coupling** — From the list, select one from the following list of input modes:

- Single-ended (16 channels)
- Differential (8 channels)

This choice must correspond to the jumper setting in block J4 on the board.

**Show error status output (E)** — Select this check box to add a port labeled **E** to the block and to display (the contents of) that special port. This output will always have a value of 0 unless a problem is detected while attempting an A/D conversion. In the unlikely event that an error occurs, the port has a nonzero value. This nonzero value takes the form of a real number whose binary representation of 1's and 0's (true and false) indicates which channels have errors.

**Sample time** — Enter the base sample time or a multiple of the base sample time.



**Base address** — Enter the base address of the board. This entry must correspond to the base address DIP switch settings on the board. For example, if the base address is 300 (hexadecimal), enter

0x300

## MM-16-AT Analog Output (D/A)

### Scaling Input to Output

| Hardware Output | Block Output Data Type | Scaling |
|-----------------|------------------------|---------|
| volts           | Double                 | 1       |

### Driver Block Parameters

**Channel vector** — Enter numbers between 1 and 4. This driver allows the selection of individual D/A channels in any order. The number of elements defines the number of D/A channels you use. For example, to use the first and second analog output (D/A) channels, enter

[1,2]

Number the channels beginning with 1 even if the board manufacturer starts numbering the channels with 0.

**Range** — From the list, select 0 to 5V or -5V to 5V as the input voltage range of the board. The input range applies to all channels.

This choice must correspond to the jumper setting in block J5 on the board.

**Reset vector** — The reset vector controls the behavior of the channel at model termination. Enter a scalar or a vector that is the same length as the channel vector. If you specify a scalar value, that setting is used for all channels. If you specify a value of 1, the corresponding channel is reset to the value specified in the initial value vector. If you specify a value of 0, the channel remains at the last value attained while the model was running.

**Initial value vector** — The initial value vector contains the initial voltage values for the input channels. Enter a scalar or a vector that is the same length as the channel vector. If you specify a scalar value, that value is the initial value for all channels. The channels are set to the initial values between the time the model is downloaded and the time it is started. If you provide an out-of-range value for a channel, that value is adjusted to lie within the correct range, as defined in the parameter **Range**.

**Sample time** — Enter the base sample time or a multiple of the base sample time.

**Base address** — Enter the base address of the board. This entry must correspond to the base address DIP switch settings on the board. For example, if the base address is 300 (hexadecimal), enter

0x300

## MM-16-AT Digital Input

Diamond-MM-16-AT boards have an 8-bit digital input port.

### Scaling Input to Output

| Hardware Output | Block Output Data Type | Scaling                         |
|-----------------|------------------------|---------------------------------|
| TTL             | Double                 | TTL low = 0.0<br>TTL high = 1.0 |

### Driver Block Parameters

**Channel vector** — Enter numbers between 1 and 8. This driver allows the selection of individual digital input channels in any order. The number of elements defines the number of digital input channels you use. For example, to use all the digital input channels, enter

[1:8]

Number the channels beginning with 1 even if the board manufacturer starts numbering the channels with 0.

**Sample time** — Enter the base sample time or a multiple of the base sample time.

**Base address** — Enter the base address of the board. This entry must correspond to the base address DIP switch settings on the board. For example, if the base address is 300 (hexadecimal), enter

0x300

## MM-16-AT Digital Output

Diamond-MM-16-AT boards have an 8-bit digital output port.

### Scaling Input to Output

| Hardware Output | Block Output Data Type | Scaling                         |
|-----------------|------------------------|---------------------------------|
| TTL             | Double                 | TTL low = 0.0<br>TTL high = 1.0 |

### Driver Block Parameters

**Channel vector** — Enter numbers between 1 and 8. This driver allows the selection of individual digital output channels in any order. The number of elements defines the number of digital output channels you use. For example, to use all of the digital output channels, enter

[1:8]

Number the channels beginning with 1 even if the board manufacturer starts numbering the channels with 0.

**Reset vector** — The reset vector controls the behavior of the channel at model termination. Enter a scalar or a vector that is the same length as the channel vector. If you specify a scalar value, that setting is used for all channels. If you specify a value of 1, the corresponding channel is reset to the value specified in the initial value vector. If you specify a value of 0, the channel remains at the last value attained while the model was running.

**Initial value vector** — The initial value vector contains the initial voltage values for the output channels. Enter a scalar or a vector that is the same length as the channel vector. If you specify a scalar value, that value is the initial value for all channels. The channels are set to the initial values between the time the model is downloaded and the time it is started. If you provide an out-of-range value for a channel, that value is adjusted to lie within the correct range, as defined in the parameter **Range**.

**Sample time** — Enter the base sample time or a multiple of the base sample time.

**Base address** — Enter the base address of the board. This entry must correspond to the base address DIP switch settings on the board. For example, if the base address is 300 (hexadecimal), enter

0x300

## Diamond-MM-32-AT

The Diamond-MM-32-AT is a PC104 I/O board with 32 single or 16 differential analog input (A/D) channels (16-bit) with a maximum sample rate of 200 kHz, 4 analog output (D/A) channels (12-bit), 24 digital input and output lines.

xPC Target supports this board with these driver blocks:

- “MM-32-AT Analog Input (A/D)” on page 17-16
- “MM-32-AT Frame Analog Input (A/D)” on page 17-17
- “MM-32-AT Analog Output (D/A)” on page 17-20
- “MM-32-AT Digital Input” on page 17-21
- “MM-32-AT Digital Output” on page 17-22

### Board Characteristics

|                                 |                              |
|---------------------------------|------------------------------|
| Board name                      | Diamond-MM-32-AT             |
| Manufacturer                    | Diamond Systems Corporation  |
| Bus type                        | ISA (PC/104)                 |
| Access method                   | I/O mapped                   |
| Multiple block instance support | A/D:No<br>D/A:Yes<br>DIO:Yes |
| Multiple board support          | Yes                          |

## MM-32-AT Analog Input (A/D)

### Scaling Input to Output

| Hardware Input | Block Output Data Type | Scaling |
|----------------|------------------------|---------|
| Volts          | Double                 | 1       |

### Driver Block Parameters

**Channel configuration** — From the list, select the following. Refer to the Diamond-MM-32-AT documentation for a description of the configuration modes.

- 1-32 SE to select the configuration mode labeled A (32 single-ended input channels)
- 1-16 DI to select the configuration mode labeled B (16 differential input channels)
- 1-8SE 9-16 DI 17-24 SE to select the configuration mode labeled D (eight single-ended input channels labeled 1 through 8, eight differential input channels labeled 9 through 16, and an additional eight single-ended input channels labeled 17 through 24).

Note that the selected channel configuration must match the configuration set by the jumpers in block J5. This driver does not support mode C.

**First channel number** — Enter the number of the first channel in a set of contiguous channels. Depending on the value of the **Channel Configuration** parameter, the first channel number must lie within the range 1 through 32, 1 through 16, or 1 through 24.

**Number of channels** — Enter the number of input channels you want to use. The maximum number of channels varies between 1 and 32 and depends on **Channel configuration** and the **First channel number**.

**Range** — From the list, choose a voltage range. The input range applies to all channels.

**Sample time** — Enter the base sample time or a multiple of the base sample time.

**Base address** — Enter the base address of the board. This entry must correspond to the DIP switch settings on the board. For example, if the base address is 300 (hexadecimal), enter

0x300

## MM-32-AT Frame Analog Input (A/D)

The Diamond-MM-32-AT Frame Analog Input block is a frame-based one. A frame consists of a fixed number of samples (defined by the **Number of scans per frame** parameter) for each of a specified set of channels. A scan is a group of samples, one for each channel.

Normally, the system timer controls an xPC Target model at intervals specified by the block **Sample Time** parameter. In contrast, the Diamond-MM-32-AT Frame Analog Input block executes the model in which it occurs each time it converts a new frame of data. You control this rate with the parameter values **Interval between scans** and **Number of scans per frame**:

$$\text{Rate} = (\text{Interval between scans}) \times (\text{Number of scans per frame})$$

You control the frame size with the parameter values **Number of channels** and **Number of scans per frame**:

$$\text{frameSize} = (\text{Number of channels}) \times (\text{Number of scans per frame})$$

After the block assembles a frame of data, it generates an interrupt, which triggers the next iteration of the model.

Note, after you add this block to a model and are ready to configure the model, edit the xPC Target code generation options.

- 1 From the model, select **Simulation -> Configuration Parameters**.
- 2 Select the **Real-Time Workshop** node.
- 3 In the **Target selection** section, from the **RTW system target file** list, browse to and select `xpctarget.tlc`.
- 4 In the **xPC Target options** node, from the **I/O board generating the interrupt** list, select the value `Diamond-MM-32`. This specifies that the Diamond-MM-32-AT board generates the interrupt.

- 5 In the same node, from the **Real-time interrupt source** list, select the IRQ number you have jumpered on the board.
- 6 In the same node, for the **PCI slot/ISA base address** parameter, enter the same ISA address as for the Diamond-MM-32-AT Frame block **Base address** parameter.
- 7 Click **OK** and save the model.

### Scaling Input to Output

| Hardware Input | Block Output Data Type | Scaling |
|----------------|------------------------|---------|
| Volts          | Double                 | 1       |

### Driver Block Parameters

**Channel configuration** — From the list, select the following. Refer to the Diamond-MM-32-AT documentation for a description of the configuration modes.

- 1-32 **Single-Ended** to select the configuration mode labeled A (32 single-ended input channels)
- 1-16 **Differential** to select the configuration mode labeled B (16 differential input channels)
- 1-8 and 7-24 **Single-Ended**; 9-16 **Differential** to select the configuration mode labeled D (eight single-ended input channels labeled 1 through 8, eight differential input channels labeled 9 through 16, and an additional eight single-ended input channels labeled 17 through 24).

Note that the selected channel configuration must match the configuration set by the jumpers in block J5. This driver does not support mode C.

**Output Signal Type** — From the list, select either **Vector** or **Frame**:

- **Vector** — Select **Vector** if you expect the output signal from this block to be the input signal for an xPC Target scope or some other block that requires vector input.



- **Frame** — Select Frame if you expect the output signal from this block to be the input signal for a block that requires a frame. For example, a Signal Processing block.

**Range** — From the list, select a voltage range. The input range applies to all channels.

**First channel number** — Enter the number of the first channel in a set of contiguous channels. Depending on the value of the **Channel Configuration** parameter, the first channel number must lie within the range 1 through 32, 1 through 16, or 1 through 24.

Number the channels starting from 1 even if Diamond Systems numbers them starting from 0.

**Number of channels** — Enter the number of input channels you want to use. The maximum number of channels varies between 1 and 32 and depends on **Channel configuration** and the **First channel number**. Note that hardware limitations require that either the **Number of channels** or **Number of scans per frame** value be even. If your application requires that both quantities be odd, add 1 to one of them and ignore the resulting additional data.

**Number of scans per frame** — Enter the number of scans per frame. For a value of N, each output port of the block will have a signal width of N and contain N samples of the corresponding channel. Note that hardware limitations require that either the **Number of channels** or **Number of scans per frame** value be even. If your application requires that both quantities be odd, add 1 to one of them and ignore the resulting additional data.

**Interval between conversions within a scan** — From the list, select the interval, in microseconds, between conversions within a scan.

**Interval between scans** — Enter the interval, in seconds, between successive scans.

**Base address** — Enter the base address of the board. This entry must correspond to the DIP switch settings on the board. For example, if the base address is 300 (hexadecimal), enter

0x300

## MM-32-AT Analog Output (D/A)

### Scaling Input to Output

| Hardware Output | Block Input Data Type | Scaling |
|-----------------|-----------------------|---------|
| Volts           | Double                | 1       |

### Driver Block Parameters

**Channel vector** — Enter numbers between 1 and 4. This driver allows the selection of individual D/A channels in any order. The number of elements defines the number of D/A channels you use. For example, to use the first and second analog output (D/A) channels, enter

[ 1, 2 ]

Number the channels beginning with 1 even if the board manufacturer starts numbering the channels with 0.

**Range** — From the list, choose a range code. This driver does not allow a different range for each of the four channels. This selection must correspond to the range and bipolar/unipolar jumper settings on the board.

The following table is a list of the ranges for this driver and the corresponding range codes. The D/A specific jumpers on the board must be in the correct positions for the ranges entered.

| Input Range (V) | Range Code | Input Range (V) | Range Code |
|-----------------|------------|-----------------|------------|
| -10 to +10      | -10        | 0 to +10        | 10         |
| -5 to +5        | -5         | 0 to +5         | 5          |

For example, if the first and second channel range is 0 to + 10 volts, enter

[ 10, 10 ]

**Reset vector** — The reset vector controls the behavior of the channel at model termination. Enter a scalar or a vector that is the same length as the channel vector. If you specify a scalar value, that setting is used for all channels. If you specify a value of 1, the corresponding channel is reset to the value specified in the initial value vector. If you specify a value of 0, the channel remains at the last value attained while the model was running.

**Initial value vector** — The initial value vector contains the initial voltage values for the output channels. Enter a scalar or a vector that is the same length as the channel vector. If you specify a scalar value, that value is the initial value for all channels. The channels are set to the initial values between the time the model is downloaded and the time it is started.

**Sample time** — Enter the base sample time or a multiple of the base sample time.

**Base address** — Enter the base address of the board. This entry must correspond to the DIP switch settings on the board. For example, if the base address is 300 (hexadecimal), enter

0x300

## MM-32-AT Digital Input

The Diamond-MM-32-AT has one 8255 chip with three ports (A,B,C). Each port has a maximum of 8 digital I/O lines that can be configured as inputs or outputs.

Use a separate driver block for each port. By selecting the digital input driver block, you configure the port as input.

### Scaling Input to Output

| Hardware Input | Block Output Data Type | Scaling                         |
|----------------|------------------------|---------------------------------|
| TTL            | Double                 | TTL low = 0.0<br>TTL high = 1.0 |

### **Driver Block Parameters**

**Channel vector** — Enter numbers between 1 and 8 to select the digital input lines used with this port. This driver allows the selection of individual digital input lines in any order. The number of elements defines the number of digital lines used.

For example, to use all the digital inputs for one port, enter

[ 1, 2, 3, 4, 5, 6, 7, 8 ]

Number the lines beginning with 1 even if the board manufacturer starts numbering the lines with 0.

**Port** — From the list choose A, B, or C. The I/O board has an 8255 chip with three ports. The **Port** parameter defines which port of the 8255 chip is used for this driver block. Each port has a maximum of eight digital lines that you can configure as inputs or outputs depending on which driver block is chosen. In each case, one block is needed for each port.

**Sample time** — Enter a base sample time or a multiple of the base sample time.

**Base address** — Enter the base address of the board. This entry must correspond to the DIP switch settings on the board. For example, if the base address is 300 (hexadecimal), enter

0x300

### **MM-32-AT Digital Output**

The Diamond-MM-32-AT has one 8255 chip with three ports (A,B,C). Each port has a maximum of eight digital I/O lines that you can configure as inputs or outputs.

Use a separate driver block for each port. By selecting the digital output driver block, you can configure the port as output.

## Scaling Input to Output

| Hardware Output | Block Input Data Type | Scaling                                                  |
|-----------------|-----------------------|----------------------------------------------------------|
| TTL             | Double                | $< 0.5 = \text{TTL low}$<br>$\geq 0.5 = \text{TTL high}$ |

### Driver Block Parameters

**Channel vector** — Enter numbers between 1 and 8 to select the digital output lines used with this port. This driver allows the selection of individual digital output lines in any order. The number of elements defines the number of digital lines used.

For example, to use all the digital outputs for one port, enter

[1,2,3,4,5,6,7,8]

Number the lines beginning with 1 even if the board manufacturer starts numbering the lines with 0.

**Port** — From the list choose either A, B, or C. The I/O board has an 8255 chip with three ports. The **Port** parameter defines which port of the 8255 chip is used for this driver block. Each port has a maximum of eight digital lines that can be configured as inputs or outputs depending on which driver block is chosen. In each case, one block is needed for each port.

**Reset vector** — The reset vector controls the behavior of the channel at model termination. Enter a scalar or a vector that is the same length as the channel vector. If you specify a scalar value, that setting is used for all channels. If you specify a value of 1, the corresponding channel is reset to the value specified in the initial value vector. If you specify a value of 0, the channel remains at the last value attained while the model was running.

**Initial value vector** — The initial value vector contains the initial values (0 or 1) of the output channels. Enter a scalar or a vector that is the same length as the channel vector. If you enter a scalar, that value is used for all channels. The channels are set to these initial values between the time the model is downloaded and the time it is started.

**Sample time** — Enter a base sample time or a multiple of the base sample time.

**Base address** — Enter the base address of the board. This entry must correspond to the DIP switch settings on the board. For example, if the base address is 300 (hexadecimal), enter

0x300

## Garnet-MM

The Garnet-MM is an I/O board with 24 or 48 high current digital I/O lines that can be configured in groups of eight for either digital input or digital output. There are two versions of this board, 24 (GMM-24) or 48 (GMM-48) digital I/O lines. The 48 line version has two 82C55 chips. Each chip has three 8-bit I/O ports for a total of 48 lines. The 24 line version has one 82C55 chip with three 8-bit I/O ports for a total of 24 lines.

xPC Target supports this board with these driver blocks:

- “Garnet-MM Digital Input” on page 17-25
- “Garnet-MM Digital Output” on page 17-26

### Board Characteristics

|                                 |                             |
|---------------------------------|-----------------------------|
| Board name                      | Garnet-MM                   |
| Manufacturer                    | Diamond Systems Corporation |
| Bus type                        | ISA (PC/104)                |
| Access method                   | I/O mapped                  |
| Multiple block instance support | DIO: Yes                    |
| Multiple board support          | Yes                         |

### Garnet-MM Digital Input

Each chip port of the Garnet-MM board can be configured independently for either input or output. Use a separate driver block for each port. Select the digital output driver block for a given port to configure the port for output.

### Scaling Input to Output

| Hardware Input | Block Output Data Type | Scaling                         |
|----------------|------------------------|---------------------------------|
| TTL            | Double                 | TTL low = 0.0<br>TTL high = 1.0 |

### Driver Block Parameters

**Channel vector** — Enter numbers between 1 and 8 to select the digital input lines used with this port. This driver allows the selection of individual digital input lines in any order. The number of elements defines the number of digital lines used.

For example, to use all the digital inputs for the current port, enter

```
[ 1, 2, 3, 4, 5, 6, 7, 8 ]
```

Number the lines beginning with 1 even if the board manufacturer starts numbering the lines with 0.

**Port** — From the list choose A, B, or C.

**Chip** — From the list choose 1 or 2. Note, only select 1 for the 24 line version of the Garnet-MM board. Selecting 2 for the 24 line board has no effect. You can select either 1 or 2 for the 48 line version of the board.

**Sample time** — Enter a base sample time or a multiple of the base sample time.

**Base address** — Enter the base address of the board. This entry must correspond to the base address board setting. For example, if the base address is 300 (hexadecimal), enter

```
0x300
```

### Garnet-MM Digital Output

Each chip port of the Garnet-MM board can be configured independently for either input or output. Use a separate driver block for each port. Select the digital input driver block for a given port to configure the port for input.

#### Scaling Input to Output

| Hardware Input | Block Output Data Type | Scaling                         |
|----------------|------------------------|---------------------------------|
| TTL            | Double                 | TTL low = 0.0<br>TTL high = 1.0 |



## Driver Block Parameters

**Channel vector** — Enter numbers between 1 and 8 to select the digital output lines used with this port. This driver allows the selection of individual digital output lines in any order. The number of elements defines the number of digital lines used.

For example, to use all the digital outputs for the current port, enter

```
[ 1, 2, 3, 4, 5, 6, 7, 8]
```

Number the lines beginning with 1 even if the board manufacturer starts numbering the lines with 0.

**Port** — From the list choose A, B, or C.

**Reset vector** — The reset vector controls the behavior of the channel at model termination. Enter a scalar or a vector that is the same length as the channel vector. If you specify a scalar value, that setting is used for all channels. If you specify a value of 1, the corresponding channel is reset to the value specified in the initial value vector. If you specify a value of 0, the channel remains at the last value attained while the model was running.

**Initial value vector** — The initial value vector contains the initial values (0 or 1) of the output channels. Enter a scalar or a vector that is the same length as the channel vector. If you enter a scalar, that value is used for all channels. The channels are set to these initial values between the time the model is downloaded and the time it is started.

**Chip** — From the list choose 1 or 2. Note, only select 1 for the 24 line version of the Garnet-MM board. Selecting 2 for the 24 line board has no effect. You can select either 1 or 2 for the 48 line version of the board.

**Sample time** — Enter a base sample time or a multiple of the base sample time.

**Base address** — Enter the base address of the board. This entry must correspond to the base address board setting. For example, if the base address is 300 (hexadecimal), enter

```
0x300
```

## Onyx-MM

The Onyx-MM is an I/O board with 48 digital I/O lines that can be configured in groups of eight for either input or output. xPC Target does not support the Counter/Timer functionality of this board.

xPC Target supports this board with these driver blocks:

- “Onyx-MM Digital Input” on page 17-28
- “Onyx-MM Digital Output” on page 17-29

### Board Characteristics

|                                 |                             |
|---------------------------------|-----------------------------|
| Board name                      | Onyx-MM                     |
| Manufacturer                    | Diamond Systems Corporation |
| Bus type                        | ISA (PC/104)                |
| Access method                   | I/O mapped                  |
| Multiple block instance support | DIO: Yes                    |
| Multiple board support          | Yes                         |

### Onyx-MM Digital Input

Onyx-MM boards have two digital I/O chips, each with three 8-bit digital I/O ports, for a total of 48 I/O lines. Each port can be configured independently for either input or output. Use a separate driver block for each port. Select the digital input driver block for a given port to configure the port for input.

### Scaling Input to Output

| Hardware Input | Block Output Data Type | Scaling                         |
|----------------|------------------------|---------------------------------|
| TTL            | Double                 | TTL low = 0.0<br>TTL high = 1.0 |

## Driver Block Parameters

**Channel vector** — Enter numbers between 1 and 8 to select the digital input lines used with this port. This driver allows the selection of individual digital input lines in any order. The number of elements defines the number of digital lines used.

For example, to use all the digital inputs for the current port, enter

```
[ 1, 2, 3, 4, 5, 6, 7, 8]
```

Number the lines beginning with 1 even if the board manufacturer starts numbering the lines with 0.

**Port** — From the list choose A, B, or C.

**Chip** — From the list choose 1 or 2.

**Sample time** — Enter a base sample time or a multiple of the base sample time.

**Base address** — Enter the base address of the board. This entry must correspond to the base address board setting. For example, if the base address is 300 (hexadecimal), enter

```
0x300
```

## Onyx-MM Digital Output

Onyx-MM boards have two digital I/O chips, each with three 8-bit digital I/O ports, for a total of 48 I/O lines. Each port can be configured independently for either input or output. Use a separate driver block for each port. Select the digital output driver block for a given port to configure a port for output.

### Scaling Input to Output

| Hardware Input | Block Output Data Type | Scaling                         |
|----------------|------------------------|---------------------------------|
| TTL            | Double                 | TTL low = 0.0<br>TTL high = 1.0 |

### **Driver Block Parameters**

**Channel vector** — Enter numbers between 1 and 8 to select the digital output lines used with this port. This driver allows the selection of individual digital output lines in any order. The number of elements defines the number of digital lines used.

For example, to use all the digital outputs for the current port, enter

```
[ 1, 2, 3, 4, 5, 6, 7, 8 ]
```

Number the lines beginning with 1 even if the board manufacturer starts numbering the lines with 0.

**Port** — From the list choose A, B, or C.

**Reset vector** — The reset vector controls the behavior of the channel at model termination. Enter a scalar or a vector that is the same length as the channel vector. If you specify a scalar value, that setting is used for all channels. If you specify a value of 1, the corresponding channel is reset to the value specified in the initial value vector. If you specify a value of 0, the channel remains at the last value attained while the model was running.

**Initial value vector** — The initial value vector contains the initial values (0 or 1) of the output channels. Enter a scalar or a vector that is the same length as the channel vector. If you enter a scalar, that value is used for all channels. The channels are set to these initial values between the time the model is downloaded and the time it is started.

**Chip** — From the list choose 1 or 2.

**Sample time** — Enter a base sample time or a multiple of the base sample time.

**Base address** — Enter the base address of the board. This entry must correspond to the base address board setting. For example, if the base address is 300 (hexadecimal), enter

```
0x300
```

## Onyx-MM-DIO

The Onyx-MM is an I/O board with 48 digital I/O lines that can be configured in groups of eight for either digital input or digital output.

xPC Target supports this board with these driver blocks:

- “Onyx-MM-DIO Digital Input” on page 17-31
- “Onyx-MM-DIO Digital Output” on page 17-32

### Board Characteristics

|                                 |                             |
|---------------------------------|-----------------------------|
| Board name                      | Onyx-MM-DIO                 |
| Manufacturer                    | Diamond Systems Corporation |
| Bus type                        | ISA (PC/104)                |
| Access method                   | I/O mapped                  |
| Multiple block instance support | DIO: Yes                    |
| Multiple board support          | Yes                         |

### Onyx-MM-DIO Digital Input

Onyx-MM-DIO boards have two digital I/O chips, each with three 8-bit digital I/O ports, for a total of 48 I/O lines. Each port can be configured independently for either input or output. Use a separate driver block for each port. Select the digital input driver block for a given port to configure the port for input.

### Scaling Input to Output

| Hardware Input | Block Output Data Type | Scaling                         |
|----------------|------------------------|---------------------------------|
| TTL            | Double                 | TTL low = 0.0<br>TTL high = 1.0 |

### Driver Block Parameters

**Channel vector** — Enter numbers between 1 and 8 to select the digital input lines used with this port. This driver allows the selection of individual digital input lines in any order. The number of elements defines the number of digital lines used.

For example, to use all the digital inputs for the current port, enter

```
[ 1, 2, 3, 4, 5, 6, 7, 8 ]
```

Number the lines beginning with 1 even if the board manufacturer starts numbering the lines with 0.

**Port** — From the list choose A, B, or C.

**Chip** — From the list choose 1 or 2.

**Sample time** — Enter a base sample time or a multiple of the base sample time.

**Base address** — Enter the base address of the board. This entry must correspond to the base address board setting. For example, if the base address is 300 (hexadecimal), enter

```
0x300
```

### Onyx-MM-DIO Digital Output

Onyx-MM-DIO boards have two digital I/O chips, each with three 8-bit digital I/O ports, for a total of 48 I/O lines. Each port can be configured independently for either input or output. Use a separate driver block for each port. Select the digital output driver block for a given port to configure a port for output.

#### Scaling Input to Output

| Hardware Input | Block Output Data Type | Scaling                         |
|----------------|------------------------|---------------------------------|
| TTL            | Double                 | TTL low = 0.0<br>TTL high = 1.0 |

## Driver Block Parameters

**Channel vector** — Enter numbers between 1 and 8 to select the digital output lines used with this port. This driver allows the selection of individual digital output lines in any order. The number of elements defines the number of digital lines used.

For example, to use all the digital outputs for the current port, enter

```
[ 1, 2, 3, 4, 5, 6, 7, 8]
```

Number the lines beginning with 1 even if the board manufacturer starts numbering the lines with 0.

**Port** — From the list choose A, B, or C.

**Reset vector** — The reset vector controls the behavior of the channel at model termination. Enter a scalar or a vector that is the same length as the channel vector. If you specify a scalar value, that setting is used for all channels. If you specify a value of 1, the corresponding channel is reset to the value specified in the initial value vector. If you specify a value of 0, the channel remains at the last value attained while the model was running.

**Initial value vector** — The initial value vector contains the initial values (0 or 1) of the output channels. Enter a scalar or a vector that is the same length as the channel vector. If you enter a scalar, that value is used for all channels. The channels are set to these initial values between the time the model is downloaded and the time it is started.

**Chip** — From the list choose 1 or 2.

**Sample time** — Enter a base sample time or a multiple of the base sample time.

**Base address** — Enter the base address of the board. This entry must correspond to the base address board setting. For example, if the base address is 300 (hexadecimal), enter

```
0x300
```

## Prometheus

The Diamond Prometheus is an Intel 486-based embedded PC/104 CPU board with 4 serial ports, 2 USB ports, 1 parallel port, keyboard and mouse ports, floppy and IDE driver connectors, a 100BaseT Ethernet connector, and provision for solid state flashdisk modules.

xPC Target supports Model PR-Z32-EA of Prometheus. In addition to the above functionality, Model PR-Z32-EA also contains a data acquisition subsystem. This subsystem supports 16 single-ended or 8 differential 16-bit A/D, 4 12-bit analog outputs, 24 programmable digital I/O channels, and a 16-bit counter/timer.

xPC Target supports the Prometheus model PR-Z32-EA with four driver blocks:

- “Prometheus Analog Input (A/D)” on page 17-35
- “Prometheus Analog Output (D/A)” on page 17-36
- “Prometheus Digital Input” on page 17-37
- “Prometheus Digital Output” on page 17-38

xPC Target does not support the counter/timer on this board.

### Board Characteristics

|                                 |                                    |
|---------------------------------|------------------------------------|
| Board name                      | Prometheus                         |
| Manufacturer                    | Diamond Systems                    |
| Bus type                        | ISA                                |
| Access method                   | I/O mapped                         |
| Multiple block instance support | A/D: No, D/A: No, Digital I/O: Yes |
| Multiple board support          | No                                 |



## Prometheus Analog Input (A/D)

### Scaling Input to Output

| Hardware Input | Block Output Data Type | Scaling |
|----------------|------------------------|---------|
| volts          | Double                 | 1       |

### Driver Block Parameters

**First channel** — Enter the number of the first channel in a set of contiguous channels. Depending on the channel configuration selected, the first channel number must lie within the range:

- 1 through 8, if the input coupling is differential.
- 1 through 16, if the input coupling is single-ended.

Number the channels beginning with 1 even if the board manufacturer starts numbering the channels with 0.

**Number of channels** — Enter the number of input channels you want to use. The maximum number of channels varies between 1 and 16 and depends on the values of **First channel** and **Input coupling**. For example, if the value of **First channel** is 1 and **Input coupling** is Single-ended, the maximum value for **Number of channels** is 16.

**Range (J13 setting)** — From the list, choose a voltage range. The input range applies to all channels. This range must agree with jumper settings in block J13 on the board.

**Input coupling (J13 setting)** — From the list, select one from the following list of input modes:

- Single-ended (16 channels)
- Differential (8 channels)

This choice must correspond to the jumper setting in block J13 on the board.

**Show error status output port** — Select this check box to display real-time error information. This check box displays an output port labeled **E**. As long as no error is detected on any of the channels currently in use, this signal has a value of 0. Values of 1, 2, 4, 8, and so forth respectively indicate problems on channels 1, 2, 3, 4, and so forth. To use one signal to indicate errors on multiple channels, the driver combines these values. For example, the **E** value  $1 + 2 = 3$  encodes the concurrent errors on channels 1 and 2, the value  $2 + 4 = 6$  encodes the concurrent errors on channels 2 and 3, and so on.

**Sample time** — Enter the base sample time or a multiple of the base sample time.

**Base address** — Enter the base address of the board. It is important that this entry corresponds to the base address setting on the board. For example, if the base address is 280 (hexadecimal), enter

0x280

## Prometheus Analog Output (D/A)

### Scaling Input to Output

| Hardware Output | Block Input Data Type | Scaling |
|-----------------|-----------------------|---------|
| volts           | Double                | 1       |

### Driver Block Parameters

**Channel Vector** — Enter a vector of numbers between 1 and 4. This driver allows the selection of individual D/A channels in any order. The number of elements defines the number of D/A channels used. For example, to use the first and second analog output (D/A) channels, enter

[1,2]

Number the channels beginning with 1 even if the board manufacturer starts numbering the channels with 0.

**Range** — From the list, choose a voltage range. The output range applies to all channels. This range must agree with jumper settings in block J13 on the board.

**Reset vector** — The reset vector controls the behavior of the channel at model termination. Enter a scalar or a vector that is the same length as the channel vector. If you specify a scalar value, that setting is used for all channels. If you specify a value of 1, the corresponding channel is reset to the value specified in the initial value vector. If you specify a value of 0, the channel remains at the last value attained while the model was running.

**Initial value vector** — The initial value vector contains the initial voltage values for the output channels. Enter a scalar or a vector that is the same length as the channel vector. If you specify a scalar value, that value is the initial value for all channels. The channels are set to the initial values between the time the model is downloaded and the time it is started.

If you provide an out-of-range value for a channel, that value is adjusted to lie within the correct range, as defined in the parameter **Range**.

**Show error status output port** — Select this check box to display real-time error information. This check box displays an output port labeled **E**. As long as no error is detected on any of the channels currently in use, this signal has a value of 0. Values of 1, 2, 4, 8, and so forth respectively indicate problems on channels 1, 2, 3, 4, and so forth. To use one signal to indicate errors on multiple channels, the driver combines these values. For example, the **E** value  $1 + 2 = 3$  encodes the concurrent errors on channels 1 and 2, the value  $2 + 4 = 6$  encodes the concurrent errors on channels 2 and 3, and so on.

**Sample time** — Base sample time of a multiple of the base sample time.

**Base address** — Enter the base address of the board. It is important that this entry correspond to the DIP switch settings on the board. For example, if the base address is 280 (hexadecimal), enter

0x280

## Prometheus Digital Input

Prometheus boards have three I/O ports, each containing 8 digital I/O lines. You can independently configure these ports for either input or output. Use a separate driver block for each port. By selecting the digital input driver block for a given port, that port is configured for input.

## Scaling Input to Output

| Hardware Input | Block Output Data Type | Scaling                         |
|----------------|------------------------|---------------------------------|
| TTL            | Double                 | TTL low = 0.0<br>TTL high = 1.0 |

### Driver Block Parameters

**Channel Vector** — Enter a vector of numbers between 1 and 8 to select the digital input lines used from this port. This driver allows the selection of individual digital input lines in any order. The number of elements defines the number of digital lines used. For example, to use all of the digital inputs for the current port, enter

[1:8]

Number the lines starting with 1 even if the board manufacturer starts numbering them with 0.

**Port** — From the list, choose A, B, or C to choose one of the three I/O ports.

**Sample time** — Enter a base sample time or a multiple of the base sample time

**Base address** — Enter the base address of the board. It is important that this entry corresponds to the DIP switch settings on the board. For example, if the base address is 280 (hexadecimal), enter

0x280

### Prometheus Digital Output

Prometheus boards have three I/O ports, each containing 8 digital I/O lines. You can independently configure these ports for either input or output. Use a separate driver block for each port. By selecting the digital output driver block for a given port, that port is configured for output.

## Scaling Input to Output

| Hardware Input | Block Output Data Type | Scaling                     |
|----------------|------------------------|-----------------------------|
| TTL            | Double                 | TTL low = 0.0TTL high = 1.0 |

### Driver Block Parameters

**Channel Vector** — Enter a vector of numbers between 1 and 8 to select the digital output lines used from this port. This driver allows the selection of individual digital output lines in any order. The number of elements defines the number of digital lines used. For example, to use all of the digital outputs for the current port, enter

[1:8]

Number the lines starting with 1 even if the board manufacturer starts numbering them with 0.

**Port** — From the list, choose A, B, or C to choose one of the three I/O ports.

**Reset vector** — The reset vector controls the behavior of the channel at model termination. Enter a scalar or a vector that is the same length as the channel vector. If you specify a scalar value, that setting is used for all channels. If you specify a value of 1, the corresponding channel is reset to the value specified in the initial value vector. If you specify a value of 0, the channel remains at the last value attained while the model was running.

**Initial value vector** — The initial value vector contains the initial voltage values for the output channels. Enter a scalar or a vector that is the same length as the channel vector. If you specify a scalar value, that value is the initial value for all channels. The channels are set to the initial values between the time the model is downloaded and the time it is started.

**Sample time** — Enter a base sample time or a multiple of the base sample time.

**Base address** — Enter the base address of the board. It is important that this entry corresponds to the DIP switch settings on the board. For example, if the base address is 280 (hexadecimal), enter

0x280

## Quartz-MM 5

The Quartz-MM 5 has 8 digital input lines, 8 digital output lines, and 10 counter/timers.

xPC Target supports this board with these driver blocks:

- “Quartz-MM 5 Digital Input” on page 17-41
- “Quartz-MM 5 Digital Output” on page 17-42
- “Quartz-MM5 Counter PWM” on page 17-43
- “Quartz-MM5 Counter PWM & ARM” on page 17-44
- “Quartz-MM5 Counter FM” on page 17-46
- “Quartz-MM5 Counter FM & ARM” on page 17-47
- “Quartz-MM5 PWM Capture” on page 17-49
- “Quartz-MM5 FM Capture” on page 17-50
- “Quartz-MMxx” on page 17-51

### Board Characteristics

|                                 |                             |
|---------------------------------|-----------------------------|
| Board name                      | Quartz-MM 5                 |
| Manufacturer                    | Diamond Systems Corporation |
| Bus type                        | ISA (PC/104)                |
| Access method                   | I/O mapped                  |
| Multiple block instance support |                             |
| Multiple board support          | Yes                         |

## Quartz-MM 5 Digital Input

### Scaling Input to Output

| Hardware Input | Block Output Data Type | Scaling                         |
|----------------|------------------------|---------------------------------|
| TTL            | Double                 | TTL low = 0.0<br>TTL high = 1.0 |

### Driver Block Parameters

**Channel vector** — Enter numbers between 1 and 8 to select the digital input lines used with this port. This driver allows the selection of individual digital input lines in any order. The number of elements defines the number of digital lines used.

For example, to use all of the digital inputs for one port, enter

```
[1,2,3,4,5,6,7,8]
```

Number the lines beginning with 1 even if the board manufacturer starts numbering the lines with 0.

**Sample time** — Enter a base sample time or a multiple of the base sample time.

**Base address** — Enter the base address of the board. This entry must correspond to the DIP switch settings on the board. For example, if the base address is 300 (hexadecimal), enter

```
0x300
```

## Quartz-MM 5 Digital Output

### Scaling Input to Output

| Hardware Output | Block Input Data Type | Scaling                             |
|-----------------|-----------------------|-------------------------------------|
| TTL             | Double                | < 0.5 = TTL low<br>≥ 0.5 = TTL high |

### Driver Block Parameters

**Channel vector** — Enter numbers between 1 and 8 to select the digital input lines used with this port. This driver allows the selection of individual digital input lines in any order. The number of elements defines the number of digital lines used.

For example, to use all of the digital inputs for one port, enter

[1,2,3,4,5,6,7,8]

Number the lines beginning with 1 even if the board manufacturer starts numbering the lines with 0.

**Sample time** — Enter a base sample time or a multiple of the base sample time.

**Base address** — Enter the base address of the board. This entry must correspond to the DIP switch settings on the board. For example, if the base address is 300 (hexadecimal), enter

0x300



## Quartz-MM5 Counter PWM

The Quartz-MM5 has one AM9513A chip with 5 counters.

The Quartz-MM5 PWM driver programs the AM9513A for PWM (Pulse Width Modulation) signal generation (a square wave with fixed frequency and variable duty cycle). The block has one input which defines the variable duty cycle between 0 and 1. For the corresponding counter channel, the PWM signal is output at the pin named OUT.

### Scaling Input to Output

| Hardware Output | Block Input Data Type | Scaling |
|-----------------|-----------------------|---------|
| TTL             | Double                | 0 to 1  |

### Driver Block Parameters

**Counter** — From the list, choose 1, 2, 3, or 4 to select which counter is used with this driver block. In each case, one block is needed for each counter.

**Frequency base** — From the list, choose F1=1MHz, F2=100kHz, F3=10kHz, F4=1kHz, or F5=100Hz to set the base frequency. The XTAL frequency is assumed to be 1MHz, therefore the jumper on the CIO-CTR05 has to be in position 1MHz not 5MHz.

**Relative output frequency** — Enter a value between 0 and  $.25 \times \text{Frequency base}$ . The **Relative output frequency** is multiplied by the **Frequency base** to set the fixed output frequency of the PWM-signal.

For example, if the output frequency of a square wave has to be 17.5 kHz, then choose F2=100kHz as the Frequency Base and enter 0.175 as the Relative Output Frequency.  $100\text{kHz} \times 0.175 = 17.5 \text{ kHz}$

---

**Note** Your control over the output frequency is not always precise. See “PWM and FM Driver Block Notes” on page 1-8 for details.

---

**Level sequence of square wave** — From the list, choose either high-low or low-high:

- If you choose high - low, the square wave period starts with the TTL high part followed by the TTL low part.
- If you choose low - high, the square wave period starts with the TTL low part followed by the TTL high part.

In either case, the duty cycle entering the block defines the duration of the TTL high part.

**Level when disarmed** — From the list, choose either high or low. The counter is automatically disarmed when the target application is not running and gets armed when the application begins running. This parameter sets the TTL level when the counter is disarmed.

**Sample time** — Enter the base sample time or a multiple of the base sample time. The sample time indicates the update rate of registration on the input (Duty Cycle)

**Base address** — Enter the base address of the board. This entry must corresponds to the DIP switch settings on the board. For example, if the base address is 300 (hexadecimal), enter

0x300

## **Quartz-MM5 Counter PWM & ARM**

The Quartz-MM5 has one AM9513A chip with 5 counters.

The Quartz-MM5 PWM & ARM driver programs the AM9513A for PWM or disarmed signal generation (a square wave with fixed frequency and variable duty cycle). Additionally the driver allows to arm and disarm the counter by the second block input. For the corresponding counter channel, the PWM signal is output at the pin named OUT.

## Scaling Input to Output

| Hardware Output | Block Input Data Type             | Scaling                               |
|-----------------|-----------------------------------|---------------------------------------|
| TTL             | Duty cycle: Double<br>Arm: Double | 0 to 1<br><0.5 disarmed<br>≥0.5 armed |

### Driver Block Parameters

**Counter** — From the list, choose 1, 2, 3, 4, or 5 to select which counter is used with this driver block. In each case, one block is needed for each counter.

**Frequency base** — From the list, choose F1=1MHz, F2=100kHz, F3=10kHz, F4=1kHz, or F5=100Hz to set the base frequency. The XTAL frequency is assumed to be 1MHz, therefore the jumper on the CIO-CTR05 has to be in position 1MHz not 5MHz.

**Relative output frequency** — Enter a value between 0 and  $.25 \times \text{Frequency base}$ . The **Relative output frequency** is multiplied by the **Frequency base** to set the fixed output frequency of the PWM-signal.

For example, if the output frequency of a square wave has to be 17.5 kHz, then choose F2=100kHz as the Frequency Base and enter 0.175 as the Relative Output Frequency.  $100\text{kHz} \times 0.175 = 17.5\text{ kHz}$

**Level sequence of square wave** — From the list, choose either high-low or low-high:

- If you choose high-low, the square wave period starts with the TTL high part followed by the TTL low part.
- If you choose low-high, the square wave period starts with the TTL low part followed by the TTL high part.

In either case, the duty cycle entering the block defines the duration of the TTL high part.

**Level when disarmed** — From the list, choose either high or low. The counter is automatically disarmed when the target application is not running. If the application is running, the second input port controls whether the counter is armed or disarmed. This parameter sets the TTL level when the counter is disarmed.

**Sample time** — Enter the base sample time or a multiple of the base sample time. The sample time indicates the update rate of registration on the input (Duty Cycle)

**Base address** — Enter the base address of the board. This entry must corresponds to the DIP switch settings on the board. For example, if the base address is 300 (hexadecimal), enter

0x300

## Quartz-MM5 Counter FM

The Quartz-MM5 has one AM9513A chip with 5 counters.

The Quartz-MM5 FM driver programs the AM9513A for FM (Frequency Modulation) signal generation (a square wave with fixed duty cycle and variable frequency). For the corresponding counter channel, the PWM signal is output at the pin named OUT.

### Scaling Input to Output

| Hardware Output | Block Input Data Type | Scaling |
|-----------------|-----------------------|---------|
| TTL             | Double                | 0 to 1  |

### Driver Block Parameters

**Counter** — From the list, choose 1, 2, 3, 4, or 5 to select which counter is used with this driver block. In each case, one block is needed for each counter.

**Frequency base** — From the list, choose F1=1MHz, F2=100kHz, F3=10kHz, F4=1kHz, or F5=100Hz to set the base frequency. XTAL frequency is assumed to be 1MHz, therefore the jumper on the CIO-CTR05 has to be in position 1MHz not 5MHz.

**Output duty cycle** — Enter a value between 0 and 1 to set the duty cycle of the square wave. The Duty Cycle is held fixed during execution of the target application.

**Level sequence of square wave** — From the list, choose either high-low or low-high:

- If you choose high-low, the square wave period starts with the TTL high part followed by the TTL low part.
- If you choose low-high, the square wave period starts with the TTL low part followed by the TTL high part.

In either case, the duty cycle entering the block defines the duration of the TTL high part.

**Level when disarmed** — From the list, choose either high or low. The counter is automatically disarmed when the target application is not running and gets armed when the application begins running. This parameter sets the TTL level when the counter is disarmed.

**Sample time** — Enter the base sample time or a multiple of the base sample time. The sample time indicates the update rate of registration on the input (Duty Cycle)

**Base address** — Enter the base address of the board. This entry must correspond to the DIP switch settings on the board. For example, if the base address is 300 (hexadecimal), enter

## Quartz-MM5 Counter FM & ARM

The Quartz-MM5 has one AM9513A chip with 5 counters.

The Quartz-MM5 FM & ARM driver programs the AM9513A for FM (Frequency Modulation) signal generation (a square wave with fixed duty cycle and variable frequency). Additionally the driver allows to arm and disarm the counter by the second block input. For the corresponding counter channel, the PWM signal is output at the pin named OUT.

## Scaling Input to Output

| Hardware Output | Block Input Data Type                     | Scaling                     |
|-----------------|-------------------------------------------|-----------------------------|
| TTL             | Variable frequency: Double<br>Arm: Double | <0.5 disarmed<br>≥0.5 armed |

### Driver Block Parameters

**Counter** — From the list, choose 1, 2, 3, 4, 5, 6, 7, 8, 9, or 10 to select which counter is used with this driver block. In each case, one block is needed for each counter.

**Frequency base** — From the list, choose F1=1MHz, F2=100kHz, F3=10kHz, F4=1kHz, or F5=100Hz to set the base frequency. The XTAL frequency is assumed to be 1MHz, therefore the jumper on the CIO-CTR05 has to be in position 1MHz not 5MHz.

**Output duty cycle** — Enter a value between 0 and 1 to set the duty cycle of the square wave. The Duty Cycle is held fixed during execution of the target application.

---

**Note** Your control over the output duty cycle is not always precise. See “PWM and FM Driver Block Notes” on page 1-8 for details.

---

**Level sequence of square wave** — From the list, choose either high-low or low-high:

- If you choose high-low, the square wave period starts with the TTL high part followed by the TTL low part.
- If you choose low-high, the square wave period starts with the TTL low part followed by the TTL high part.

In either case, the **Output duty cycle** defined in the setting above define the duration of the TTL high part.

**Level when disarmed** — From the list, choose either high or low. The counter is automatically disarmed when the target application is not running. If the application is running, the second input port controls whether the counter is armed or disarmed. This parameter sets the TTL level when the counter is disarmed.

**Sample time** — Enter the base sample time or a multiple of the base sample time. The sample time indicates the update rate of registration on the input (Duty Cycle)

**Base address** — Enter the base address of the board. This entry must correspond to the DIP switch settings on the board. For example, if the base address is 300 (hexadecimal), enter

0x300

## Quartz-MM5 PWM Capture

This block programs the AMD9513A for capturing PWM signals by using two counters. One counter measures the cycle duration, and the other counter measures the duration the signal is high.

There are two outputs. One output is the relative frequency compared to the base frequency. The other output is the duty cycle. To get the actual frequency, multiply the base frequency by the relative frequency.

The PWM signal has to enter the pins named GATE of both corresponding counter channels (parallel wiring). Both CLK pins have to be left unconnected.

### Scaling Input to Output

| Hardware Output | Block Input Data Type | Scaling |
|-----------------|-----------------------|---------|
| TTL             | Double                | 0 to 1  |

### Driver Block Parameters

**Counter** — From the list, choose 1&2, 2&3, 3&4, or 4&5. This selects which two counters the driver block uses to determine the PWM. Use one block for each pair of counters. No two blocks should use the same counter. For example, use counters 1&2 for one block and 3&4 for a second block. Do not use a combination like 1&2 and 2&3.

**Frequency base** — From the list, choose F1=1MHz, F2=100kHz, F3=10kHz, F4=1kHz, or F5=100Hz to set the base frequency. The XTAL frequency is assumed to be 1MHz, therefore the jumper on the Quartz-MM5 has to be in position 1MHz not 5MHz.

**Sample time** — Enter the base sample time or a multiple of the base sample time. The sample time indicates the update rate of registration on the input (Duty Cycle)

**Base address** — Enter the base address of the board. This entry must corresponds to the DIP switch settings on the board. For example, if the base address is 300 (hexadecimal), enter

0x300

## Quartz-MM5 FM Capture

This block programs the AMD9513A for capturing FM signals.

There is one output for relative frequency compared to the base frequency. To get the actual frequency, multiply the base frequency by the relative frequency.

The FM signal has to enter the pin named GATE of the corresponding counter channel. The CLK pin has to be left unconnected.

### Scaling Input to Output

| Hardware Output | Block Input Data Type | Scaling |
|-----------------|-----------------------|---------|
| TTL             | Double                | 0 to 1  |

### Driver Block Parameters

**Counter** — From the list, choose 1, 2, 3, 4 or 5. This selects which counter the driver block uses to determine the FM. In each case, one block is needed for each counter.

**Frequency base** — From the list, choose F1=1MHz, F2=100kHz, F3=10kHz, F4=1kHz, or F5=100Hz to set the base frequency. The XTAL frequency is assumed to be 1MHz, therefore the jumper on the Quartz-MM5 has to be in position 1MHz not 5MHz.



**Sample time** — Enter the base sample time or a multiple of the base sample time. The sample time indicates the update rate of registration on the input (Duty Cycle)

**Base address** — Enter the base address of the board. This entry must corresponds to the DIP switch settings on the board. For example, if the base address is 300 (hexadecimal), enter

0x300

### **Quartz-MMxx**

You can use this block to program the AMD9513A counter. The PWM, PWM & ARM, FM, FM & ARM, PWM Capture, and FM Capture blocks use this block in their underlying subsystems. The API for this block is not currently documented.

## Quartz-MM 10

The Quartz-MM 10 has eight digital input line, eight digital output lines, and 10 counter/timers.

xPC Target supports this board with these driver blocks:

- “Quartz-MM 10 Digital Input” on page 17-53
- “Quartz-MM 10 Digital Output” on page 17-54
- “Quartz-MM 10 Counter PWM” on page 17-54
- “Quartz-MM 10 Counter PWM & ARM” on page 17-56
- “Quartz-MM 10 Counter FM” on page 17-57
- “Quartz-MM 10 Counter FM & ARM” on page 17-59
- “Quartz-MM 10 PWM Capture” on page 17-60
- “Quartz-MM 10 FM Capture” on page 17-61
- “Quartz-MMxx” on page 17-62

### Board Characteristics

|                                 |                             |
|---------------------------------|-----------------------------|
| Board name                      | Quartz-MM 10                |
| Manufacturer                    | Diamond Systems Corporation |
| Bus type                        | ISA (PC/104)                |
| Access method                   | I/O mapped                  |
| Multiple block instance support | Yes                         |
| Multiple board support          | Yes                         |

## Quartz-MM 10 Digital Input

### Scaling Input to Output

| Hardware Input | Block Output Data Type | Scaling                         |
|----------------|------------------------|---------------------------------|
| TTL            | Double                 | TTL low = 0.0<br>TTL high = 1.0 |

### Driver Block Parameters

**Channel vector** — Enter numbers between 1 and 8 to select the digital input lines used with this port. This driver allows the selection of individual digital input lines in any order. The number of elements defines the number of digital lines used.

For example, to use all the digital inputs for one port, enter

```
[1,2,3,4,5,6,7,8]
```

Number the lines beginning with 1 even if the board manufacturer starts numbering the lines with 0.

**Sample time** — Enter a base sample time or a multiple of the base sample time.

**Base address** — Enter the base address of the board. This entry must correspond to the DIP switch settings on the board. For example, if the base address is 300 (hexadecimal), enter

```
0x300
```

## Quartz-MM 10 Digital Output

### Scaling Input to Output

| Hardware Output | Block Input Data Type | Scaling                                                  |
|-----------------|-----------------------|----------------------------------------------------------|
| TTL             | Double                | $< 0.5 = \text{TTL low}$<br>$\geq 0.5 = \text{TTL high}$ |

### Driver Block Parameters

**Channel vector** — Enter numbers between 1 and 8 to select the digital input lines used with this port. This driver allows the selection of individual digital input lines in any order. The number of elements defines the number of digital lines used.

For example, to use all the digital inputs for one port, enter

```
[ 1, 2, 3, 4, 5, 6, 7, 8 ]
```

Number the lines beginning with 1 even if the board manufacturer starts numbering the lines with 0.

**Sample time** — Enter a base sample time or a multiple of the base sample time.

**Base address** — Enter the base address of the board. This entry must correspond to the DIP switch settings on the board. For example, if the base address is 300 (hexadecimal), enter

```
0x300
```

## Quartz-MM 10 Counter PWM

The Quartz-MM10 has two AM9513A chips with five counters each.

The Quartz-MM10 PWM driver programs the AM9513A for PWM (pulse width modulation) signal generation (a square wave with fixed frequency and variable duty cycle). The block has one input that defines the variable duty cycle between 0 and 1. For the corresponding counter channel, the PWM signal is output at the pin named OUT.

## Scaling Input to Output

| Hardware Output | Block Input Data Type | Scaling |
|-----------------|-----------------------|---------|
| TTL             | Double                | 0 to 1  |

### Driver Block Parameters

**Counter** — From the list, choose 1, 2, 3, 4, or 5 to select which counter is used with this driver block. In each case, one block is needed for each counter.

**Frequency base** — From the list, choose F1=4MHz, F2=400kHz, F3=40kHz, F4=4kHz, or F5=400Hz to set the base frequency. The XTAL frequency is assumed to be 1 MHz; therefore the jumper on the Quartz MM-10 must be in position 1 MHz not 5 MHz.

**Relative output frequency** — Enter a value between 0 and  $.25 \times \text{Frequency base}$ . The **Relative output frequency** is multiplied by the **Frequency base** to set the fixed output frequency of the PWM signal.

For example, if the output frequency of a square wave must be 17.5 kHz, then choose F2=100kHz as the **Frequency base** and enter 0.175 as the **Relative output frequency**.  $100 \text{ kHz} \times 0.175 = 17.5 \text{ kHz}$

**Level sequence of square wave** — From the list, choose either high-low or low-high:

- If you choose high-low, the square wave period starts with the TTL high part followed by the TTL low part.
- If you choose low-high, the square wave period starts with the TTL low part followed by the TTL high part.

In either case, the duty cycle entering the block defines the duration of the TTL high part.

**Level when disarmed** — From the list, choose either high or low. The counter is automatically disarmed when the target application is not running and becomes armed when the application begins running. This parameter sets the TTL level when the counter is disarmed.

**Sample time** — Enter the base sample time or a multiple of the base sample time. The sample time indicates the update rate of registration on the input (duty cycle)

**Base address** — Enter the base address of the board. This entry must correspond to the DIP switch settings on the board. For example, if the base address is 300 (hexadecimal), enter

0x300

## Quartz-MM 10 Counter PWM & ARM

The Quartz-MM 10 has two AM9513A chips with five counters.

The Quartz-MM 10 PWM & ARM driver programs the AM9513A for PWM or disarmed signal generation (a square wave with fixed frequency and variable duty cycle). Additionally the driver allows you to arm and disarm the counter by using the second block input. For the corresponding counter channel, the PWM signal is output at the pin named OUT.

### Scaling Input to Output

| Hardware Output | Block Input Data Type             | Scaling                               |
|-----------------|-----------------------------------|---------------------------------------|
| TTL             | Duty cycle: Double<br>Arm: Double | 0 to 1<br><0.5 disarmed<br>≥0.5 armed |

### Driver Block Parameters

**Counter** — From the list, choose 1, 2, 3, 4, or 5 to select which counter is used with this driver block. In each case, one block is needed for each counter.

**Frequency base** — From the list, choose F1=1MHz, F2=100kHz, F3=10kHz, F4=1kHz, or F5=100Hz to set the base frequency. The XTAL frequency is assumed to be 1 MHz, therefore the jumper on the Quartz-MM 10 must be in position 1 MHz not 5 MHz.

**Relative output frequency** — Enter a value between 0 and .25\***Frequency base**. The **Relative output frequency** is multiplied by the **Frequency base** to set the fixed output frequency of the PWM signal.

For example, if the output frequency of a square wave must be 17.5 kHz, then choose F2=100kHz as the **Frequency base** and enter 0.175 as the **Relative output frequency**. 100 kHz x 0.175 = 17.5 kHz

**Level sequence of square wave** — From the list, choose either high-low or low-high:

- If you choose high-low, the square wave period starts with the TTL high part followed by the TTL low part.
- If you choose low-high, the square wave period starts with the TTL low part followed by the TTL high part.

In either case, the duty cycle entering the block defines the duration of the TTL high part.

**Level when disarmed** — From the list, choose either high or low. The counter is automatically disarmed when the target application is not running. If the application is running, the second input port controls whether the counter is armed or disarmed. This parameter sets the TTL level when the counter is disarmed.

**Sample time** — Enter the base sample time or a multiple of the base sample time. The sample time indicates the update rate of registration on the input (duty cycle)

**Base address** — Enter the base address of the board. This entry must correspond to the DIP switch settings on the board. For example, if the base address is 300 (hexadecimal), enter

0x300

## Quartz-MM 10 Counter FM

The Quartz-MM10 has two AM9513A chips with five counters.

The Quartz-MM10 FM driver programs the AM9513A for FM (frequency modulation) signal generation (a square wave with fixed duty cycle and variable frequency). For the corresponding counter channel, the FM signal is output at the pin named OUT.

## Scaling Input to Output

| Hardware Output | Block Input Data Type | Scaling |
|-----------------|-----------------------|---------|
| TTL             | Double                | 0 to 1  |

### Driver Block Parameters

**Counter** — From the list, choose 1, 2, 3, 4, or 5 to select which counter is used with this driver block. In each case, one block is needed for each counter.

**Frequency base** — From the list, choose F1=4MHz, F2=400kHz, F3=40kHz, F4=4kHz, or F5=400Hz to set the base frequency. XTAL frequency is assumed to be 1 MHz; therefore the jumper on the Quartz-MM 10 must be in position 1 MHz not 5 MHz.

**Output duty cycle** — Enter a value between 0 and 1 to set the duty cycle of the square wave. The duty cycle is held fixed during execution of the target application.

---

**Note** Your control over the output duty cycle is not always precise. See “PWM and FM Driver Block Notes” on page 1-8 for details.

---

**Level sequence of square wave** — From the list, choose either high-low or low-high:

- If you choose high-low, the square wave period starts with the TTL high part followed by the TTL low part.
- If you choose low-high, the square wave period starts with the TTL low part followed by the TTL high part.

In either case, the duty cycle entering the block defines the duration of the TTL high part.

**Level when disarmed** — From the list, choose either high or low. The counter is automatically disarmed when the target application is not running and becomes armed when the application begins running. This parameter sets the TTL level when the counter is disarmed.



**Sample time** — Enter the base sample time or a multiple of the base sample time. The sample time indicates the update rate of registration on the input (duty cycle)

**Base address** — Enter the base address of the board. This entry must correspond to the DIP switch settings on the board. For example, if the base address is 300 (hexadecimal), enter

0x300

## Quartz-MM 10 Counter FM & ARM

The Quartz-MM 10 has two AM9513A chips with five counters.

The Quartz-MM 10 FM & ARM driver programs the AM9513A for FM (frequency modulation) signal generation (a square wave with fixed duty cycle and variable frequency). Additionally the driver allows you to arm and disarm the counter by the second block input. For the corresponding counter channel, the FM signal is output at the pin named OUT.

### Scaling Input to Output

| Hardware Output | Block Input Data Type                     | Scaling                     |
|-----------------|-------------------------------------------|-----------------------------|
| TTL             | Variable frequency: Double<br>Arm: Double | <0.5 disarmed<br>≥0.5 armed |

### Driver Block Parameters

**Counter** — From the list, choose 1, 2, 3, 4, 5, 6, 7, 8, 9, or 10 to select which counter is used with this driver block. In each case, one block is needed for each counter.

**Frequency base** — From the list, choose F1=1MHz, F2=100kHz, F3=10kHz, F4=1kHz, or F5=100Hz to set the base frequency. The XTAL frequency is assumed to be 1 MHz; therefore the jumper on the Quartz-MM 10 must be in position 1 MHz not 5 MHz.

**Output duty cycle** — Enter a value between 0 and 1 to set the duty cycle of the square wave. The duty cycle is held fixed during execution of the target application.

---

**Note** Your control over the output duty cycle is not always precise. See “PWM and FM Driver Block Notes” on page 1-8 for details.

---

**Level sequence of square wave** — From the list, choose either high-low or low-high:

- If you choose high-low, the square wave period starts with the TTL high part followed by the TTL low part.
- If you choose low-high, the square wave period starts with the TTL low part followed by the TTL high part.

In either case, the **Output duty cycle** defined in the setting above defines the duration of the TTL high part.

**Level when disarmed** — From the list, choose either high or low. The counter is automatically disarmed when the target application is not running. If the application is running, the second input port controls whether the counter is armed or disarmed. This parameter sets the TTL level when the counter is disarmed.

**Sample time** — Enter the base sample time or a multiple of the base sample time. The sample time indicates the update rate of registration on the input (duty cycle).

**Base address** — Enter the base address of the board. This entry must correspond to the DIP switch settings on the board. For example, if the base address is 300 (hexadecimal), enter

0x300

## **Quartz-MM 10 PWM Capture**

This block programs the AM9513A for capturing PWM signals by using two counters. One counter measures the cycle duration, and the other counter measures the length of time the signal is high.

There are two outputs. One output is the relative frequency compared to the base frequency. The other output is the duty cycle. To get the actual frequency, multiply the base frequency by the relative frequency.

The PWM signal must enter the pins of both corresponding counter channels (parallel wiring) named GATE. Both CLK pins must be left unconnected.

### Scaling Input to Output

| Hardware Output | Block Input Data Type | Scaling |
|-----------------|-----------------------|---------|
| TTL             | Double                | 0 to 1  |

### Driver Block Parameters

**Counter** — From the list, choose 1&2, 2&3, 3&4, 4&5, 6&7, 7&8, 8&9, or 9&10. This selects which two counters the driver block uses to determine the PWM. Use one block for each pair of counters. No two blocks should use the same counter. For example, use counters 1&2 for one block and 3&4 for a second block. Do not use a combination like 1&2 and 2&3.

**Frequency base** — From the list, choose F1=1MHz, F2=100kHz, F3=10kHz, F4=1kHz, or F5=100Hz to set the base frequency. The XTAL frequency is assumed to be 1 MHz, therefore the jumper on the Quartz-MM 10 must be in position 1 MHz not 5 MHz.

**Sample time** — Enter the base sample time or a multiple of the base sample time. The sample time indicates the update rate of registration on the input (duty cycle)

**Base address** — Enter the base address of the board. This entry must correspond to the DIP switch settings on the board. For example, if the base address is 300 (hexadecimal), enter

0x300

### Quartz-MM 10 FM Capture

This block programs the AM9513A for capturing FM signals.

There is one output for relative frequency compared to the base frequency. To get the actual frequency, multiply the base frequency by the relative frequency.

The FM signal must enter the pin of the corresponding counter channel named GATE. The CLK pin must be left unconnected.

## Scaling Input to Output

| Hardware Output | Block Input Data Type | Scaling |
|-----------------|-----------------------|---------|
| TTL             | Double                | 0 to 1  |

### Driver Block Parameters

**Counter** — From the list, choose 1, 2, 3, 4, 5, 6, 7, 8, 9, or 10. This selects which counter the driver block uses to determine the FM. In each case, one block is needed for each counter.

**Frequency base** — From the list, choose F1=1MHz, F2=100kHz, F3=10kHz, F4=1kHz, or F5=100Hz to set the base frequency. The XTAL frequency is assumed to be 1 MHz, therefore the jumper on the Quartz-MM 10 must be in position 1 MHz not 5 MHz.

**Sample time** — Enter the base sample time or a multiple of the base sample time. The sample time indicates the update rate of registration on the input (duty cycle).

**Base address** — Enter the base address of the board. This entry must correspond to the DIP switch settings on the board. For example, if the base address is 300 (hexadecimal), enter

0x300

### Quartz-MMxx

You can use this block to program the AM9513A counter. The PWM, PWM & ARM, FM, FM & ARM, PWM Capture, and FM Capture blocks use this block in their underlying subsystems. The API for this block is not currently documented.

## Ruby-MM

The Diamond Ruby-MM is a PC104 I/O board with 4 or 8 single analog output (D/A) channels (12-bit), unipolar and bipolar operation, +/- 10V, +/- 5V, 0-10V, 0-5V fixed ranges, +/- 2.5V, 0-2.5V user-adjustable ranges, 24 digital input and output lines.

xPC Target supports this board with these driver blocks:

- “Diamond Ruby-MM Analog Output (D/A)” on page 17-63
- “Diamond Ruby-MM Digital Input” on page 17-65
- “Diamond Ruby-MM Digital Output” on page 17-66

### Board Characteristics

|                                 |                             |
|---------------------------------|-----------------------------|
| Board name                      | Diamond Ruby-MM             |
| Manufacturer                    | Diamond Systems Corporation |
| Bus type                        | ISA (PC/104)                |
| Access method                   | I/O Mapped                  |
| Multiple block instance support | D/A:No, DIO:Yes             |
| Multiple board support          | Yes                         |

## Diamond Ruby-MM Analog Output (D/A)

### Scaling Input to Output

| Hardware Output | Block Input Data Type | Scaling |
|-----------------|-----------------------|---------|
| Volts           | Double                | 1       |

### Driver Block Parameters

**Channel vector** — List the output channels as a vector. Up to 8 different channels can be listed. To specify the first three channels, enter

[1,2,3]

The board comes in two different hardware versions. If the 4-channel version of the hardware is used and the channels 5-8 are listed, the those outputs will not show an error, but the data will be ignored.

**Range** — The output range of the board is selected with jumpers on the board. Each group of 4 channels can be jumpered for any of the available ranges. The range you select in the Block Parameters must correspond to the range specified by the jumper settings or you will obtain incorrect results.

**Reset vector** – The reset vector controls the behavior of the channel at model termination. Enter a scalar or a vector that is the same length as the channel vector. If you specify a scalar value, that setting is used for all channels. If you specify a value of 1, the corresponding channel is reset to the value specified in the initial value vector. If you specify a value of 0, the channel remains at the last value attained while the model was running.

**Initial value vector** – The initial value vector contains the initial voltage values for the output channels. Enter a scalar or a vector that is the same length as the channel vector. If you specify a scalar value, that value is the initial value for all channels. The channels are set to the initial values between the time the model is downloaded and the time it is started.

**Sample time** — Enter the base sample time or a multiple of the base sample time.

**Base address** — Enter the base address of the board in hexadecimal (such as 0x300) as selected with the hardware jumpers on the board.

---

**Note** Please consult the appropriate Diamond Ruby-MM hardware manuals for more information on jumper settings and I/O connections.

---

## Diamond Ruby-MM Digital Input

### Scaling Input to Output

| Hardware Input | Block Output Data Type | Scaling                         |
|----------------|------------------------|---------------------------------|
| TTL            | Double                 | TTL low = 0.0<br>TTL high = 1.0 |

### Driver Block Parameters

**Channel vector** — Enter numbers between 1 and 8 to select the digital input lines to be read. This driver allows the selection of up to 8 individual digital input lines in any order. The number of elements defines the number of digital lines used.

For example, to use all of the digital inputs enter

```
[1,2,3,4,5,6,7,8]
```

Number the lines beginning with 1 even though the board manufacturer starts numbering lines with 0.

**Port** — From the **Port** list, choose either A, B, or C. The **Port** parameter defines which port is used for this driver block. Each port has a maximum of 8 digital inputs. In each case, one block is needed for each port.

**Sample time** — Enter the base sample time or a multiple of the base sample time.

**Base address** — Enter the base address of the board in hexadecimal (such as 0x300) as selected with the hardware jumpers on the board.

---

**Note** Please consult the appropriate Diamond Ruby-MM hardware manuals for more information on jumper settings and I/O connections.

---

## Diamond Ruby-MM Digital Output

### Scaling Input to Output

| Hardware Output | Block Input Data Type | Scaling                             |
|-----------------|-----------------------|-------------------------------------|
| TTL             | Double                | < 0.5 = TTL low<br>≥ 0.5 = TTL high |

### Driver Block Parameters

**Channel vector** — Enter numbers between 1 and 8 to select the digital output lines to drive. This driver allows the selection of up to 8 individual digital output lines in any order. The number of elements defines the number of digital lines used.

For example, to use all of the digital inputs enter

```
[ 1, 2, 3, 4, 5, 6, 7, 8 ]
```

Number the lines beginning with 1 even though the board manufacturer starts numbering lines with 0.

**Port** — From the **Port** list, choose either A, B, or C. The **Port** parameter defines which port is used for this driver block. Each port has a maximum of 8 digital outputs. In each case, one block is needed for each port.

**Reset vector** — The reset vector controls the behavior of the channel at model termination. Enter a scalar or a vector that is the same length as the channel vector. If you specify a scalar value, that setting is used for all channels. If you specify a value of 1, the corresponding channel is reset to the value specified in the initial value vector. If you specify a value of 0, the channel remains at the last value attained while the model was running.

**Initial value vector** — The initial value vector contains the initial values (0 or 1) of the output channels. Enter a scalar or a vector that is the same length as the channel vector. If you enter a scalar, that value is used for all channels. The channels are set to these initial values between the time the model is downloaded and the time it is started.

**Sample time** — Enter the base sample time or a multiple of the base sample time.



**Base address** — Enter the base address of the board in hexadecimal (such as 0x300) as selected with the hardware jumpers on the board.

---

**Note** Please consult the appropriate Diamond Ruby-MM hardware manuals for more information on jumper settings and I/O connections.

---

## Ruby-MM-416

The Ruby-MM-416 is an I/O board with four 16-bit analog output (D/A) channels, and 24 digital I/O lines that can be configured in groups of eight for either input or output.

xPC Target supports this board with these driver blocks:

- “Ruby-MM-416 Analog Output (D/A)” on page 17-68
- “Ruby-MM-416 Digital Input” on page 17-70
- “Ruby-MM-416 Digital Output” on page 17-71

### Board Characteristics

|                                 |                             |
|---------------------------------|-----------------------------|
| Board name                      | Ruby-MM-416                 |
| Manufacturer                    | Diamond Systems Corporation |
| Bus type                        | ISA (PCI/104)               |
| Access method                   | I/O Mapped                  |
| Multiple block instance support | D/A:No<br>DIO:Yes           |
| Multiple board support          | Yes                         |

### Ruby-MM-416 Analog Output (D/A)

#### Scaling Input to Output

| Hardware Output | Block Input Data Type | Scaling |
|-----------------|-----------------------|---------|
| Volts           | Double                | 1       |

## Driver Block Parameters

**Channel vector** — Enter a vector containing channel numbers between 1 and 4. This driver allows the selection of individual D/A channels in any order. The number of elements defines the number of D/A channels used. For example, to use the first and second analog output (D/A) channels, enter

```
[1,2]
```

Number the channels beginning with 1 even if the board manufacturer starts numbering the channels with 0.

**Range vector** — The range vector must be a scalar or a vector the same length as the channel vector. The vector entries must use range codes from the following table

| Input Range (V) | Range Code |
|-----------------|------------|
| -10 to +10      | -10        |
| -5 to +5        | -5         |
| 0 to 10         | 10         |

The range codes you enter must be consistent with the jumper settings on the board.

**Reset vector** — The reset vector controls the behavior of the channel at model termination. Enter a scalar or a vector that is the same length as the channel vector. If you specify a scalar value, that setting is used for all channels. If you specify a value of 1, the corresponding channel is reset to the value specified in the initial value vector. If you specify a value of 0, the channel remains at the last value attained while the model was running.

**Initial value vector** — The initial value vector contains the initial voltage values for the output channels. Enter a scalar or a vector that is the same length as the channel vector. If you specify a scalar value, that value is the initial value for all channels. The channels are set to the initial values between the time the model is downloaded and the time it is started. If you provide a value that is out of the channel's range, the value is reset to the lower or upper range value.

**Sample time** — Base sample time or a multiple of the base sample time.

**Base address** — Enter the base address of the board. This entry must correspond to the base address setting on the board (header J6). For example, if the base address is 300 (hexadecimal), enter

0x300

## Ruby-MM-416 Digital Input

Ruby-MM-416 boards have three I/O ports, each containing eight digital I/O lines. These ports can be configured independently for either input or output. Use a separate driver block for each port. By selecting the digital input driver block for a given port, you configure that port for input.

### Scaling Input to Output

| Hardware Input | Block Output Data Type | Scaling                         |
|----------------|------------------------|---------------------------------|
| TTL            | Double                 | TTL low = 0.0<br>TTL high = 1.0 |

### Driver Block Parameters

**Channel vector** — Enter numbers between 1 and 8 to select the digital input lines used with this port. This driver allows the selection of individual digital input lines in any order. The number of elements defines the number of digital lines used.

For example, to use all the digital inputs for the current port, enter

[1,2,3,4,5,6,7,8]

Number the lines beginning with 1 even if the board manufacturer starts numbering the lines with 0.

**Port** — From the list choose A, B, or C.

**Sample time** — Enter a base sample time or a multiple of the base sample time.

**Base address** — Enter the base address of the board. This entry must correspond to the base address board setting. For example, if the base address is 300 (hexadecimal), enter

0x300

## Ruby-MM-416 Digital Output

Ruby-MM-416 boards have three I/O ports, each containing eight digital I/O lines. These ports can be configured independently for either input or output. Use a separate driver block for each port. By selecting the digital input driver block for a given port, that port is configured for input.

### Scaling Input to Output

| Hardware Input | Block Output Data Type | Scaling                         |
|----------------|------------------------|---------------------------------|
| TTL            | Double                 | TTL low = 0.0<br>TTL high = 1.0 |

### Driver Block Parameters

**Channel vector** — Enter numbers between 1 and 8 to select the digital output lines used with this port. This driver allows the selection of individual digital output lines in any order. The number of elements defines the number of digital lines used.

For example, to use all the digital outputs for the current port, enter

[1,2,3,4,5,6,7,8]

Number the lines beginning with 1 even if the board manufacturer starts numbering the lines with 0.

**Port** — From the list choose A, B, or C.

**Sample time** — Enter a base sample time or a multiple of the base sample time.

**Base address** — Enter the base address of the board. This entry must correspond to the base address board setting. For example, if the base address is 300 (hexadecimal), enter

0x300

## Ruby-MM-1612

The Ruby-MM-1612 is an I/O board with 16 (12-bit) analog output (D/A) channels, and 24 digital I/O lines that can be configured in groups of eight for either input or output.

xPC Target supports this board with these driver blocks:

- “Ruby-MM-1612 Analog Output (D/A)” on page 17-73
- “Ruby-MM-1612 Digital Input” on page 17-76
- “Ruby-MM-1612 Digital Output” on page 17-77

### Board Characteristics

|                                 |                             |
|---------------------------------|-----------------------------|
| Board name                      | Ruby-MM-1612                |
| Manufacturer                    | Diamond Systems Corporation |
| Bus type                        | ISA (PC/104)                |
| Access method                   | I/O Mapped                  |
| Multiple block instance support | D/A:No<br>DIO:Yes           |
| Multiple board support          | Yes                         |

### Ruby-MM-1612 Analog Output (D/A)

#### Scaling Input to Output

| Hardware Output | Block Input Data Type | Scaling |
|-----------------|-----------------------|---------|
| Volts           | Double                | 1       |

#### Driver Block Parameters

**Channel vector** — Enter a vector containing channel numbers between 1 and 16. This driver allows the selection of individual D/A channels in any order.

The number of elements defines the number of D/A channels used. For example, to use the first and second analog output (D/A) channels, enter

[1,2]

Number the channels beginning with 1 even if the board manufacturer starts numbering the channels with 0.

**Range for bank 1, Range for bank 2** — Bank 1 consists of channels 1 to 8 and bank 2 consists of channels 9 to 16. The output range may be specified on a per-bank basis. These ranges must correspond to the jumper settings in header R4 on the board. See the board manual for details.

Note that if you select a range of either -5V to +5V or 0 to +5V for one bank, then it is not possible to select a range of either -10V to +10V or 0 to +10V for the other bank. This is because jumper 5 in header J4 (On-Board Reference Full-Scale Voltage Selection) affects all channels, not just those of a single bank. See the board manual for details. The following lists the allowed output voltage range combinations for the two channel banks. **B1** is the first bank of channels, **B2** is the second bank of channels.

| <b>B1</b> | <b>B2</b> | <b>Configuration</b> |
|-----------|-----------|----------------------|
| ±10 V     | ±10 V     | C11                  |
| 0-10 V    | ±10 V     | C41                  |
| ±5 V      | ±5 V      | C22                  |
| ±2.5      | ±5 V      | C32                  |
| 0-5 V     | ±5 V      | C52                  |
| 0-2.5 V   | ±5 V      | C62                  |
| ±5 V      | ±2.5 V    | C23                  |
| ±2.5 V    | ±2.5 V    | C33                  |
| 0-5 V     | ±2.5 V    | C53                  |
| 0-2.5 V   | ±2.5 V    | C63                  |
| ±10 V     | 0-10 V    | C14                  |



| <b>B1</b> | <b>B2</b> | <b>Configuration</b> |
|-----------|-----------|----------------------|
| 0-10 V    | 0-10 V    | C44                  |
| ±5 V      | 0-5 V     | C25                  |
| ±2.5 V    | 0-5 V     | C35                  |
| 0-5 V     | 0-5 V     | C55                  |
| 0-2.5 V   | 0-5 V     | C65                  |
| ±5 V      | 0-2.5 V   | C26                  |
| ±2.5 V    | 0-2.5 V   | C36                  |
| 0-5 V     | 0-2.5 V   | C56                  |
| 0-2.5 V   | 0-2.5 V   | C66                  |

This driver supports the Adjustable Reference Voltage. You can use this feature with either output range -2.5V to +2.5V or 0 to +2.5V. If for example you adjust potentiometer R4 to 2.3 V (instead of the default setting of 2.5), then an input signal of 1.2 results in an output voltage of  $(1.2 / 2.5) * 2.3 \text{ V} = 1.1 \text{ V}$ . See the board manual for details.

**Reset vector** — The reset vector controls the behavior of the channel at model termination. Enter a scalar or a vector that is the same length as the channel vector. If you specify a scalar value, that setting is used for all channels. If you specify a value of 1, the corresponding channel is reset to the value specified in the initial value vector. If you specify a value of 0, the channel remains at the last value attained while the model was running.

**Initial value vector** — The initial value vector contains the initial voltage values for the output channels. Enter a scalar or a vector that is the same length as the channel vector. If you specify a scalar value, that value is the initial value for all channels. The channels are set to the initial values between the time the model is downloaded and the time it is started. If you provide a value that is out of the channel's range, the value is reset to the lower or upper range value.

**Sample time** — Base sample time of a multiple of the base sample time.

**Base address** — Enter the base address of the board. This entry must correspond to the DIP switch settings on the board. For example, if the base address is 300 (hexadecimal), enter

0x300

## Ruby-MM-1612 Digital Input

Ruby-MM-1612 boards have three I/O ports, each containing eight digital I/O lines. These ports can be configured independently for either input or output. Use a separate driver block for each port. By selecting the digital input driver block for a given port, that port is configured for input.

### Scaling Input to Output

| Hardware Input | Block Output Data Type | Scaling                         |
|----------------|------------------------|---------------------------------|
| TTL            | Double                 | TTL low = 0.0<br>TTL high = 1.0 |

### Driver Block Parameters

**Channel vector** — Enter numbers between 1 and 8 to select the digital input lines used with this port. This driver allows the selection of individual digital input lines in any order. The number of elements defines the number of digital lines used.

For example, to use all the digital inputs for the current port, enter

[1,2,3,4,5,6,7,8]

Number the lines beginning with 1 even if the board manufacturer starts numbering the lines with 0.

**Port** — From the list choose A, B, or C.

**Sample time** — Enter a base sample time or a multiple of the base sample time.

**Base address** — Enter the base address of the board. This entry must correspond to the base address board setting. For example, if the base address is 300 (hexadecimal), enter

0x300

## Ruby-MM-1612 Digital Output

Ruby-MM-1612 series boards have three I/O ports, each containing eight digital I/O lines. These ports can be configured independently for either input or output. Use a separate driver block for each port. By selecting the digital output driver block for a given port, you configure that port for output.

### Scaling Input to Output

| Hardware Input | Block Output Data Type | Scaling                         |
|----------------|------------------------|---------------------------------|
| TTL            | Double                 | TTL low = 0.0<br>TTL high = 1.0 |

### Driver Block Parameters

**Channel vector** — Enter numbers between 1 and 8 to select the digital output lines used with this port. This driver allows the selection of individual digital output lines in any order. The number of elements defines the number of digital lines used.

For example, to use all the digital outputs for the current port, enter

[1,2,3,4,5,6,7,8]

Number the lines beginning with 1 even if the board manufacturer starts numbering the lines with 0.

**Port** — From the list choose A, B, or C.

**Reset vector** — The reset vector controls the behavior of the channel at model termination. Enter a scalar or a vector that is the same length as the channel vector. If you specify a scalar value, that setting is used for all channels. If you specify a value of 1, the corresponding channel is reset to the value specified in the initial value vector. If you specify a value of 0, the channel remains at the last value attained while the model was running.

**Initial value vector** — The initial value vector contains the initial voltage values for the output channels. Enter a scalar or a vector that is the same length as the channel vector. If you specify a scalar value, that value is the initial value for all channels. The channels are set to the initial values between the time the model is downloaded and the time it is started. If you provide a value that is out of the channel's range, the value is reset to the lower or upper range value.

**Sample time** — Enter a base sample time or a multiple of the base sample time.

**Base address** — Enter the base address of the board. This entry must correspond to the base address board setting. For example, if the base address is 300 (hexadecimal), enter

0x300

# General Standards

---

I/O boards supported by xPC Target (<http://www.generalstandards.com>).

Overview of PMC-ADADIO  
Functionality (p. 18-2)

Description of how the PMC-ADADIO blocks can be  
configured to interact with one another and other blocks.

PMC-ADADIO (p. 18-14)

High performance multifunction board that has eight 16  
bit analog to digital converters and eight 16 bit digital to  
analog outputs. The board also has 8 bits of TTL level  
digital I/O.

PMC-16AO-12 (p. 18-25)

High speed board that has twelve 16 bit analog outputs.

## Overview of PMC-ADADIO Functionality

The PMC-ADADIO board is an analog I/O PCI mezzanine card (PMC) device that can be used for a number of applications, such as data acquisition and process monitoring.

xPC Target supports this board with A/D and D/A driver blocks. The following xPC Target driver blocks control the A/D functionality of the PMC-ADADIO board:

- “PMC-ADADIO Analog Input (A/D) Start” on page 18-15
- “PMC-ADADIO Analog Input (A/D) Read” on page 18-16

The following xPC Target driver blocks control the D/A functionality of the PMC-ADADIO board:

- “PMC-ADADIO Analog Output (D/A) Write” on page 18-17
- “PMC-ADADIO Analog Output (D/A) Update” on page 18-20

The use of these drivers differ slightly from other boards. Of particular note are the Boolean enable ports (labelled E) that most of the A/D and D/A blocks have for input and/or output. These enable ports perform the following:

- Control block action. If the value of the input enable port is true, the block executes. If the value is false, the block does not execute. Most blocks also have output enable ports. The output enable port has the same value as the input enable port. This allows the control block action value to be passed to successive blocks.
- Ensure that A/D and/or D/A blocks execute in the correct order. For example, the A/D Start block starts the analog to digital conversion of the channels selected by the A/D Read block. This block must finish its operation before the A/D Read block can execute. If the A/D Read block executes first, the A/D Read block waits indefinitely for the A/D conversion to complete.

An input enable port can have an Enable Signal block connected to the port. The Enable Signal block generates an input enable signal for the A/D and D/A blocks. If you do not connect an Enable Signal block to the A/D or D/A block, the input enable port has a constant value of 1, or ‘true.’

A typical A/D block configuration for analog input operation connects the AD Start block and AD Read block. Because the A/D Start block can take several microseconds to perform the analog to digital conversion of the channels selected by the A/D Read block, you can perform other operations in the meantime. For example, you can insert a typical D/A block configuration between the AD Start and Read blocks. A typical configuration for analog output operation connects the DA Write and DA Update blocks.

This section describes how to use the PMC-Adadio blocks to create a model that interleaves the analog input and analog output operations. It has the following topics:

- “A/D Blocks” on page 18-3
- “Create Enable Signal Blocks” on page 18-5
- “D/A Blocks” on page 18-8
- “Interleaving Analog Input and Analog Output Blocks” on page 18-10
- “Using Multiple Boards for Simultaneous Analog to Digital Conversion” on page 18-12

## A/D Blocks

A typical A/D block configuration for analog input operation connects the AD Start block and AD Read block. The AD Start block converts the data of the channels selected by the AD Read block.

### Adding A/D Blocks to a Model for Analog Input

- 1 In the MATLAB Command Window, type

```
xpplib
```

The xPC Target driver block library opens.

- 2 Double-click the A/D group block.

A window with blocks for A/D drivers opens.

- 3 Double-click the General Standards group block.

A window with blocks for General Standards opens.

- 4 From the File menu, select **New -> Model**.
- 5 Drag and drop an AD Start block from the General Standards window to the new model.

By default, this block should have the **Enable input port** and **Enable output port** check boxes selected.

- 6 Drag and drop an AD Read block from the General Standards window to the new model.

By default, this block has the **Enable input port** and **Enable output port** check boxes selected. Double-click the AD Read block and deselect the **Enable output port**. Deselecting this check box prohibits the block from passing the Boolean value from the input enable port to the output enable port.

- 7 Connect the AD Start block to the AD Read block.

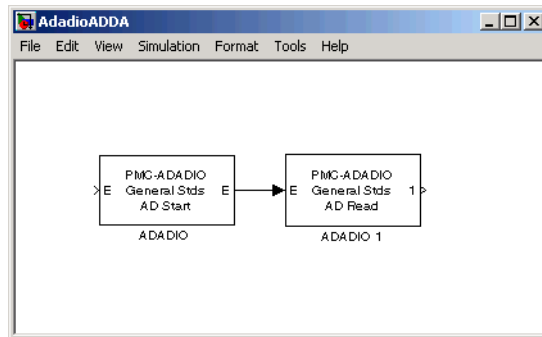

Note the following

- No signal has been connected to the AD Start block's input enable port, E, so the port has a default value of 'true'. Accordingly, the output enable port of the AD Start block and input enable port of the AD Read block also have a value of 'true'. You can drag and drop a Ground block from the Simulink Source library and connect that block to the unconnected input port of AD Start to prevent build errors until you add another block. You can drag and drop a Terminator block from the Simulink Sink library and connect that



block to unconnected output ports of AD Read to prevent build errors until you add other blocks.

- Connecting the output enable port of the AD Start block to the input enable port of the AD Read block ensures that the AD Start block executes before the AD Read block. The AD Start block initiates the A/D conversion. The Read block waits until the conversion has completed before putting the results on its output port.

---

**Note** The Start block must execute before every call to the Read block. If the Read block is executed without the Start block, the system hangs because it is waiting for data to be available.

---

- 8 From the File menu, select **Save As**. Browse to a writable directory and enter a unique model name. For example, AdadioADDA, then click Save.

Your next task is to add a Create Enable Signal block to this model. See “Adding Enable Signal Blocks to A/D Blocks” on page 18-6.

## Create Enable Signal Blocks

The A/D and D/A series of blocks both have Create Enable Signal blocks.

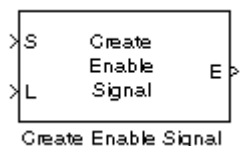

You can use a Create Enable Signal block to generate an input enable signal for A/D and D/A blocks. You can connect a signal generator to the input of the Create Enable Signal block to control the output enable port. You can then connect the output E port of the Create Enable Signal block to the input E port of an A/D or D/A block.

### Adding Enable Signal Blocks to A/D Blocks

This procedure assumes that you have a model named AdadioADDA (see “Adding A/D Blocks to a Model for Analog Input” on page 18-3). Add a Create Enable Signal block to generate an input enable signal for the AD Start block. If you have Ground or Terminator blocks, remove them as you make connections to the additional blocks.

- 1** If your model AdadioADDA is not already open, in the MATLAB Command Window, type

```
AdadioADDA
```

The model opens.

- 2** In the MATLAB window, type

```
xpcLib
```

The xPC Target library opens.

- 3** Double-click the A/D group block.

A window with blocks for A/D drivers opens.

- 4** Double-click the General Standards group block.

A window with blocks for General Standards opens.

- 5** Drag and drop a Create Enable Signal block from the General Standards window to the new model.

- 6** Double click the Create Enable Signal block and deselect the Show input port for thresholding signal of type double.

The Create Enable block has an output enable port, E, that can provide an input enable signal for any of the other PMC-ADADIO blocks. The Boolean value of this output enable port is controlled by an input port, S, and (optionally) an input port, L. When the S port is connected to the output of an arbitrary block B, the Create Enable Signal block executes immediately after block B executes. The L port is a level-sensitive thresholding port that allows an attached signal to control the Boolean value at the output enable port E.

**7** Click **Start -> Simulink -> Library Browser**.

**8** Click Sources. The Sources pane displays the included blocks.

**9** Drag and drop a Sine Wave block to the new model.

**10** Connect the output port of the Sine Wave block to the input port S of the Create Enable Signal block.

Connecting the Sine Wave to the Create Enable Signal block triggers the sequence chain of the ADADIO blocks.

**11** In the new model, connect the S port of the Create Enable Signal block to the Sine Wave block.

**12** In the new model, connect the AD Start block E port to the Create Enable Signal block E port.

The output enable port, E, of the Create Enable Signal block provides the first Boolean output to feed into the other ADADIO driver blocks.

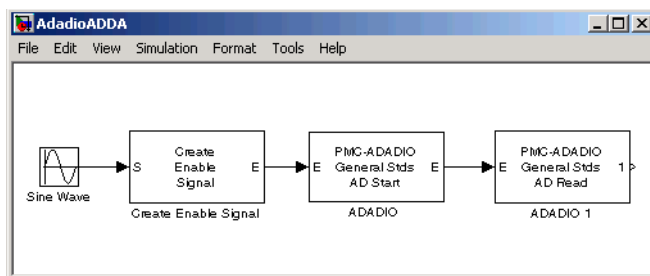

**13** From the File menu, select **Save**.

Your next task is to set up the D/A blocks to provide the analog output for the analog input blocks.

## **D/A Blocks**

A typical D/A block configuration for analog output operation connects the DA Write block and DA Update block. The DA Update block converts the data that the DA Write block puts out.

### **Adding D/A Blocks to a Model for Analog Output**

- 1** If the model AdadioADDA is not already open, in the MATLAB Command Window, type  

```
AdadioADDA
```

The model opens.
- 2** In the MATLAB window, type  

```
xpclib
```

The xPC Target library opens.
- 3** Double-click the D/A group block.  

A window with blocks for D/A drivers opens.
- 4** Double-click the General Standards group block.  

A window with blocks for General Standards opens.
- 5** Drag and drop a DA Write block from the General Standards window to the new model.
- 6** Drag and drop a DA Update block from the General Standards window to the new model.
- 7** Connect the DA Update block to the DA Write block.

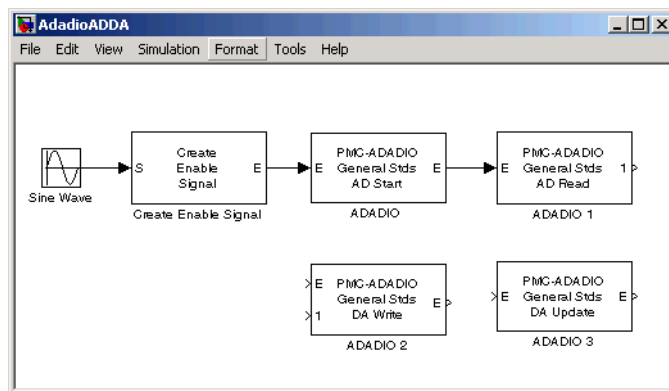

Note the following:

- No signal has been connected to the DA Write block's input enable port, E, so the port has a default value of 'true'. Accordingly, the output enable port of the DA Write block and input enable port of the DA Update block also have a value of 'true'.
- Connecting the output enable port of the DA Write block to the input enable port of the DA Update block ensures that the DA Write block executes before the DA Update block. The DA Write block loads the PMC-ADADIO registers in preparation for the D/A conversion. The DA Update block waits until the loading has completed before initiating the D/A conversion. As with the AD Start and Read blocks, the DA Write and Update blocks do not need to be directly connected to each other. You can interleave other blocks if you want.

You can interleave the analog output blocks between the AD Start and AD Read blocks. Such a configuration allows the analog output block to perform concurrently with the A/D conversion by the AD Start block. To connect to the AD Start and AD Read blocks, the interleaving block(s) must have an input enable port and an output enable port. See "Interleaving Analog Input and Analog Output Blocks" on page 18-10.

## Interleaving Analog Input and Analog Output Blocks

After the AD Start block executes, the acquisition hardware becomes busy with the operation. If you have the AD Read block execute immediately, it will idle waiting for the hardware to finish the acquisition. Rather than allowing idle cycles, you can insert other blocks between the AD Start and AD Read block. You can insert

- An atomic subsystem that has a pass through input for the enable signal from the AD Start to the AD Read blocks. This type of system enforces an execution order where the inserted subsystem executes between the other two blocks.
- A pair of blocks that already have an enable port, such as DA Write and DA Update. Because the DA Write and DA Update blocks already have an enable port, you do not have to include them in another subsystem to ensure correct execution order. See the following enable line for the execution order:
  - a AD Start enable out to DA Write enable in
  - b DA Write enable out to DA Update enable in
  - c DA Update enable out to AD Read enable in

This results in the time sequence: AD Start -> DA Write -> DA Update -> AD Read. By the time AD Read executes, the hardware has either finished or is much closer to finishing. Less time is wasted than if you use no interleaving. Note that the data input to DA Write comes from another part of the model. Typically, it will be the value calculated from the AD Read from the previous time step.

The following procedure assumes that you have a model named AdadioADDA that has AD Start and Read blocks, an Enable Create Signal block, and DA Write and Update blocks:

- 1 If the model AdadioADDA is not already open, in the MATLAB Command Window, type  

```
AdadioADDA
```

The model opens.

- 2** In the MATLAB window, type

```
xpclib
```

The xPC Target library opens.

- 3** Disconnect the AD Start block from the AD Read block.

Perform this step to insert the intermediate DA blocks between the AD Start and Read blocks.

- 4** Connect the output E port of the AD Start block to the input E port of the DA Write block.
- 5** Connect the output port of the Sine Wave block to the input 1 port of the DA Write block.
- 6** Connect the output E port of the DA Write block to the input E port of the DA Update block.
- 7** Connect the output E port of the DA Update block to the input E port of the AD Read block.
- 8** At the xPC Target library, double-click the Misc group block
- 9** Drag and drop the Scope (xPC) block into the AdadioADDA model.
- 10** Connect the output E port of the AD Read block to the Scope (xPC) block.

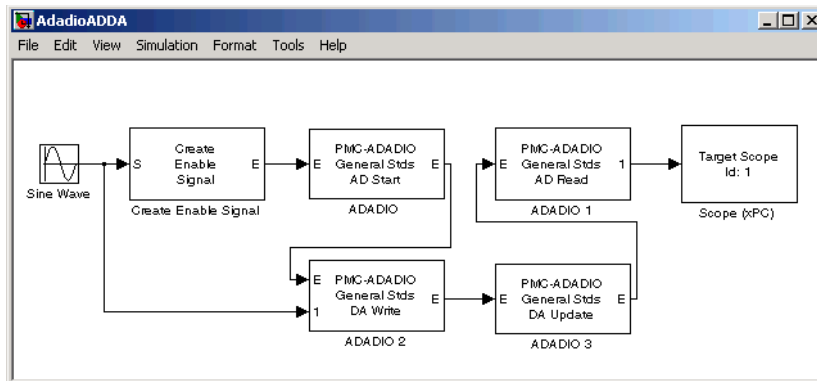

**11** From the File menu, select Save.

You can build and run the model and download it to your target PC like any other xPC Target model.

## **Using Multiple Boards for Simultaneous Analog to Digital Conversion**

The previous topics describe how to set up a model for up to eight channels performing simultaneous analog to digital conversion. You can increase the number of channels for this conversion by using two or more PMC-ADADIO boards, configured in a master/slave configuration.

In such a configuration, observe the following guidelines:

- Decide how many slave PMC-ADADIO boards you want in your configuration.
- Identify one PMC-ADADIO as the master board.
- Create a model that uses the master PMC-ADADIO board. This model must contain an A/D Start block for the master board.
- For each PMC-ADADIO board in your system, including the master and all slave boards, the model must contain an associated A/D Read block.
- Connect the Enable output port (E) of the A/D Start block of the master board to the Enable input port (E) of each of the slave A/D Read blocks. You can do this in one of the following ways. Note that the order in which the A/D Read blocks are connected is irrelevant.
  - Directly connect the Enable output port (E) of the A/D Start block to the Enable input port (E) of each of the slave A/D Read blocks.
  - Directly connect the Enable output port (E) of the A/D Start block to the Enable input port (E) of the first slave A/D Read block, then create a daisy chain of slave Enable input to Enable output ports for the slave A/D Read blocks. For example



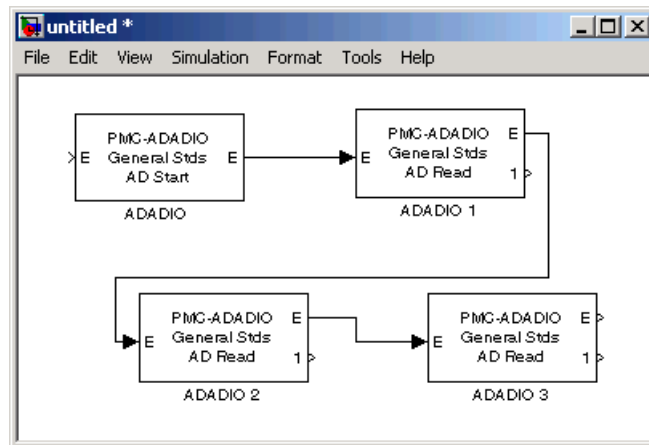

- Connect pin4 of the P5B connector (INPUT TRIGGER READY signal) of the master board to pin 2 of the P5B connector (INPUT TRIGGER signal) of all the slave boards. For example

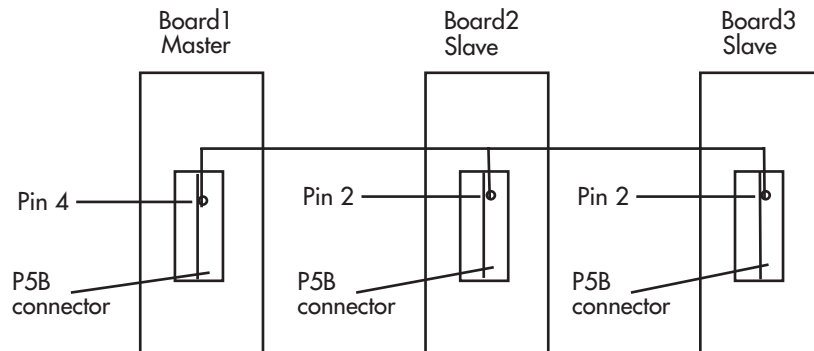

**Note** The pulse of the master board INPUT TRIGGER READY output occurs 250 nanoseconds after the software trigger in the A/D Start block. This results in a 250 nanosecond delay, relative to the master board, for the slave boards, but should still be considered simultaneous in most situations.

## PMC-ADADIO

The PMC-ADADIO is a high performance multifunction board that has eight 16 bit analog to digital converters and four 16 bit digital to analog outputs. Up to eight input channels are sampled simultaneously from a single acquisition start. The board also has 8 bits of TTL level digital I/O. All 8 bits are either inputs or outputs.

You can purchase the PMC-ADADIO board in either a memory mapped or an I/O mapped configuration. The driver detects this configuration and adjusts for it. In addition, you order the board for a specific factory configured voltage range. Consult the board's documentation to determine the voltage range of your board.

xPC Target supports this board with these driver blocks:

- “PMC-ADADIO Analog Input (A/D) Start” on page 18-15
- “PMC-ADADIO Analog Input (A/D) Read” on page 18-16
- “PMC-ADADIO Analog Output (D/A) Write” on page 18-17
- “PMC-ADADIO Analog Output (D/A) Update” on page 18-20
- “PMC-ADADIO Digital Input” on page 18-21
- “PMC-ADADIO Digital Output” on page 18-22
- “Create Enable Signal” on page 18-24

Note that you cannot use the PMC-ADADIO Digital Input and Digital Output driver blocks simultaneously on the same board. Trying to do so results in an error.

## Board Characteristics

|                                 |                             |
|---------------------------------|-----------------------------|
| Board name                      | PMC-ADADIO                  |
| Manufacturer                    | General Standards           |
| Bus type                        | PCI                         |
| Access method                   | Memory mapped or I/O mapped |
| Multiple block instance support | No                          |
| Multiple board support          | Yes                         |

## PMC-ADADIO Analog Input (A/D) Start

### Scaling Input to Output

The values passed to the enable input port and enable output port of this block are Boolean values.

### Driver Block Parameters

**Enable input port** — Select this check box to display the enable input port that controls the execution of the A/D conversion. If the enable input signal is true, the A/D conversion begins. If the enable input signal is false, then the A/D conversion is not started. If this check box is not selected, then the enable input signal is assumed to be true.

**Enable output port** — Select this check box to pass the Boolean value from the input enable port to the output enable port. You can connect this port to the input enable port on another block to control other blocks in the model and specify execution ordering.

**Sample time** — Enter the base sample time or a multiple of the base sample time.

**PCI Slot (-1:autosearch)** — If only one board of this type is physically present in the target PC, enter

- 1

to automatically locate the board.

If two or more boards of this type are physically present in the target PC, enter the bus number and the PCI slot number of the board associated with this

driver block. Use the format [BusNumber, SlotNumber]. To determine the bus number and the PCI slot number, type

```
getxpcpci
```

## PMC-ADADIO Analog Input (A/D) Read

### Scaling Input to Output

| Hardware Input | Block Output Data Type | Scaling |
|----------------|------------------------|---------|
| volts          | Double                 | 1       |

The values passed to the enable input port and enable output port of this block are Boolean values.

### Driver Block Parameters

**Number of channels** — Enter a scalar between 1 and 8 to select the number of channels from which to acquire data. This board always acquires data from the channels in chronological order with no random access to channel selection. For example, if you enter 3, data is acquired from channels 1, 2 and 3. Select a number between 1 and 8 even though the hardware manual numbers the channels from 0 to 7.

**Range option** — From the list, select + -10V, + -5V or + -2.5V as the input voltage range of the board. You must select the range that corresponds to the factory configured input range. Consult the board's documentation to determine the voltage range of your board. xPC Target uses this parameter to convert the data to floating point numbers.

**Input coupling** — From the list, select Single-ended (8 channels) or Differential (8 channels). See the board's hardware manual for information on how to wire the board for these configurations.

**Autocalibration** — The PMC-ADADIO can check its own calibration (autocalibration) against an internal voltage reference. Choose this check box to execute the autocalibration cycle when the model is downloaded to the xPC Target target PC. The calibration cycle takes several seconds to run. The output ports show a square wave during the cycle. Refer to the PMC-ADADIO documentation for further information on autocalibration.

**Enable input port** — Select this check box to display an input port that controls writing data from the A/D ports on the hardware. If the enable input signal is true, then the output of the A/D converter is read and output to the block output port. If the enable input signal is false, then zero data is output to the block output port. If this check box is not selected, then the enable input signal is assumed to be true.

**Enable output port** — Select this check box to pass the Boolean value from the input enable port to the output enable port. You can connect this port to the input enable port on another block to control other blocks in the model and specify execution ordering.

**Sample time** — Enter the base sample time or a multiple of the base sample time.

**PCI Slot (-1:autosearch)** — If only one board of this type is physically present in the target PC, enter

-1

to automatically locate the board.

If two or more boards of this type are physically present in the target PC, enter the bus number and the PCI slot number of the board associated with this driver block. Use the format [BusNumber, SlotNumber]. To determine the bus number and the PCI slot number, type

```
getxpcpci
```

## PMC-ADADIO Analog Output (D/A) Write

Data from 1 to 4 input data streams is written to the hardware digital to analog output registers when the enable port also receives a true value. If the enable port is not used, then it is assumed to be true always. The output registers are held and not written through to the output converters until the analog output update block is executed.

## Scaling Input to Output

| Hardware Output | Block Input Data Type | Scaling |
|-----------------|-----------------------|---------|
| volts           | Double                | 1       |

The values passed to the enable input port and enable output port of this block are Boolean values.

### Driver Block Parameters

**Channel vector** — Enter a vector of numbers between 1 and 4 to select the analog output lines to drive. Number the lines beginning with 1 even though the board manufacturer starts numbering the lines with 0.

**Reset vector** — The reset vector controls the behavior of the channel at model termination. Enter a scalar or a vector that is the same length as the channel vector. If you specify a scalar value, that setting is used for all channels. If you specify a value of 1, the corresponding channel is reset to the value specified in the initial value vector. If you specify a value of 0, the channel remains at the last value attained while the model was running. For example, if **Channel vector** is [ 2 3 ] and the **Reset vector** is [ 1 ], the action taken will be the same as if **Reset vector** was set to [ 1 1 ]. Both channels will be reset to their initial values when model execution is stopped.

**Initial value vector** — The initial value vector contains the initial voltage values for the output channels. Enter a scalar or a vector that is the same length as the channel vector. If you specify a scalar value, that value is the initial value for all channels. The channels are set to the initial values between the time the model is downloaded and the time it is started. When model execution is stopped, the corresponding position in **Reset vector** is checked. Depending on that value, the channel is either reset to the initial value or remains at the last value attained while the model was running. For example, assume that **Channel vector** is [ 2 5 8 ], **Reset vector** is [ 1 0 1 ], and **Initial value vector** is [ 2.3 5.6 0 ]. On initial download, channel 2 is set to 2.3 volts, channel 5 to 5.6 volts, and channel 8 to 0.0 volts. When the model is stopped, channel 2 resets to 2.3 volts, channel 5 remains at the last value attained, and channel 8 resets to 0.0 volts.

**Range vector** — From the list, select  $+ - 10V$ ,  $+ - 5V$  or  $+ - 2.5V$  as the output voltage range of the board. You must select the range that corresponds to the factory configured output range. Consult the board's documentation to determine the voltage range of your board. xPC Target uses this parameter to convert the data from floating point numbers to integers.

**Autocalibration** — The PMC-ADADIO can check its own calibration (autocalibration) against an internal voltage reference. Choose this check box to execute the autocalibration cycle when the model is downloaded to the xPC Target target PC. The calibration cycle takes several seconds to run. The output ports show a square wave during the cycle. Refer to the PMC-ADADIO documentation for further information on autocalibration.

**Enable input port** — Select this check box to display an input enable port that controls writing data to the D/A ports on the hardware. If the enable input signal is true, then the block input data is written to the D/A ports on the hardware. If the enable input signal is false, then data is not written to the D/A ports on the hardware and the output remains at the previous value. If this check box is not selected, then the enable input signal is assumed to be true.

**Enable output port** — Select this check box to pass the Boolean value from the input enable port to the output enable port. You can connect this port to the input enable port on another block to control other blocks in the model and specify execution ordering.

**Sample time** — Enter the base sample time or a multiple of the base sample time.

**PCI Slot (-1:autosearch)** — If only one board of this type is physically present in the target PC, enter

- 1

to automatically locate the board.

If two or more boards of this type are physically present in the target PC, enter the bus number and the PCI slot number of the board associated with this driver block. Use the format [BusNumber, SlotNumber]. To determine the bus number and the PCI slot number, type

```
getxpcpci
```

## PMC-ADADIO Analog Output (D/A) Update

### Scaling Input to Output

The values passed to the enable input port and enable output port of this block are Boolean values.

### Driver Block Parameters

**Enable input port** — Select this check box to display an input enable port that controls writing data to the D/A ports on the hardware. If the enable input signal is true, then the block input data is written to the D/A ports on the hardware. If the enable input signal is false, then data is not written to the D/A ports on the hardware and the output remains at the previous value. If this check box is not selected, then the enable input signal is assumed to be true.

**Enable output port** — Select this check box to pass the Boolean value from the input enable port to the output enable port. You can connect this port to the input enable port on another block to control other blocks in the model and specify execution ordering.

**Sample time** — Enter the base sample time or a multiple of the base sample time.

**PCI Slot (-1:autosearch)** — If only one board of this type is physically present in the target PC, enter

-1

to automatically locate the board.

If two or more boards of this type are physically present in the target PC, enter the bus number and the PCI slot number of the board associated with this driver block. Use the format [BusNumber, SlotNumber]. To determine the bus number and the PCI slot number, type

```
getxpcpci
```



## PMC-ADADIO Digital Input

Note that you cannot use the PMC-ADADIO Digital Input and Digital Output driver blocks simultaneously on the same board. Doing so causes an error at model update or build.

### Scaling Input to Output

| Hardware Input | Block Output Data Type | Scaling                         |
|----------------|------------------------|---------------------------------|
| TTL            | Double                 | TTL low = 0.0<br>TTL high = 1.0 |

The values passed to the enable input port and enable output port of this block are Boolean values.

### Driver Block Parameters

**Channel vector** — Enter numbers between 1 and 8 to select the digital input lines to be read. This driver allows the selection of individual digital input lines in any order. The number of elements defines the number of digital lines used.

For example, to use all of the digital inputs, enter

```
[1,2,3,4,5,6,7,8]
```

Number the lines beginning with 1 even though the board manufacturer starts numbering the lines with 0. Note that the 8 digital lines are either all input or all output.

**Enable input port** — Select this check box to display an input enable port that controls writing data from the digital input ports on the hardware. If the enable input signal is true, then the digital input values are read and output to the block output port. If the enable input signal is false, then zero data is output to the block output port. If this check box is not selected, then the enable input signal is assumed to be true.

**Enable output port** — Select this check box to pass the Boolean value from the input enable port to the output enable port. You can connect this port to the input enable port on another block to control other blocks in the model and specify execution ordering.

**Sample time** — Enter the base sample time or a multiple of the base sample time.

**PCI Slot (-1:autosearch)** — If only one board of this type is physically present in the target PC, enter

-1

to automatically locate the board.

If two or more boards of this type are physically present in the target PC, enter the bus number and the PCI slot number of the board associated with this driver block. Use the format [BusNumber, SlotNumber]. To determine the bus number and the PCI slot number, type

getxpcpci

## PMC-ADADIO Digital Output

Note that you cannot use the PMC-ADADIO Digital Input and Digital Output driver blocks simultaneously on the same board. Doing so causes an error at model update or build.

### Scaling Input to Output

| Hardware Output | Block Input Data Type | Scaling                             |
|-----------------|-----------------------|-------------------------------------|
| TTL             | Double                | < 0.5 = TTL low<br>≥ 0.5 = TTL high |

The values passed to the enable input port and enable output port of this block are Boolean values.

### Driver Block Parameters

**Channel vector** — Enter numbers between 1 and 8 to select the digital output lines to be written. This driver allows the selection of individual digital output lines in any order. The number of elements defines the number of digital lines used.

For example, to use all of the digital outputs, enter

[1,2,3,4,5,6,7,8]

Number the lines beginning with 1 even though the board manufacturer starts numbering the lines with 0. Note that the 8 digital lines are either all input or all output.

**Reset vector** — The reset vector controls the behavior of the channel at model termination. Enter a scalar or a vector that is the same length as the channel vector. If you specify a scalar value, that setting is used for all channels. If you specify a value of 1, the corresponding channel is reset to the value specified in the initial value vector. If you specify a value of 0, the channel remains at the last value attained while the model was running. For example, if **Channel vector** is [ 2 3 ] and the **Reset vector** is [ 1 ], the action taken will be the same as if **Reset vector** was set to [ 1 1 ]. Both channels will be reset to their initial values when model execution is stopped.

**Initial value vector** — The initial value vector contains the initial logical values for the output channels. Enter a scalar or a vector that is the same length as the channel vector. These values can only contain 1's and 0's. If you specify a scalar value, that value is the initial value for all channels. The channels are set to the initial values between the time the model is downloaded and the time it is started. When model execution is stopped, the corresponding position in **Reset vector** is checked. Depending on that value, the channel is either reset to the initial value or remains at the last value attained while the model was running. For example, assume that **Channel vector** is [ 2 5 8 ], **Reset vector** is [ 1 0 1 ], and **Initial value vector** is [ 1 1 0 ]. On initial download, channel 2 is set to high, channel 5 to high, and channel 8 to low. When the model is stopped, channel 2 resets to high, channel 5 remains at the last value attained, and channel 8 resets to low.

**Enable input port** — Select this check box to display an input enable port that controls writing data to the digital output ports on the hardware. If the enable input signal is true, then the block input data is written to the digital output ports on the hardware. If the enable input signal is false, then data is not written to the digital output ports on the hardware and the output remains at the previous value. If this check box is not selected, then the enable input signal is assumed to be true.

**Enable output port** — Select this check box to pass the Boolean value from the input enable port to the output enable port. You can connect this port to the input enable port on another block to control other blocks in the model and specify execution ordering.

**Sample time** — Enter the base sample time or a multiple of the base sample time.

**PCI Slot (-1:autosearch)** — If only one board of this type is physically present in the target PC, enter

-1

to automatically locate the board.

If two or more boards of this type are physically present in the target PC, enter the bus number and the PCI slot number of the board associated with this driver block. Use the format [BusNumber, SlotNumber]. To determine the bus number and the PCI slot number, type

```
getxpcpci
```

## Create Enable Signal

Use the Create Enable Signal block to determine whether a series of blocks executes as well as to start the sequence of the blocks' execution. For example, connect another block in your model to the input port S to trigger the sequence chain of the ADADIO blocks. The output enable port, E, provides the first Boolean output to feed into the other ADADIO driver blocks.

### Scaling Input to Output

The values passed to the enable output port of this block are Boolean values.

### Driver Block Parameters

**Show input port for thresholding signal of type double** — Select this check box to display the level input port, L. Connect the signal whose level you want to compare to the threshold value to this port.

If this check box is not selected, then the output enable port has a Boolean value of true. The output enable port provides a link for sequencing the execution of your blocks.

**Enable threshold** — Enter a threshold value. If the block input signal connected to the level input port, L, is above this threshold, the output enable port has a Boolean value of true. If the input signal is below this threshold, the output enable port has a Boolean value of false.

## PMC-16AO-12

The PMC-16AO12 board is a high speed board that has twelve 16-bit analog outputs. In this section, PMC-16AO12 refers to the board, PMC-16AO-12 refers to the xPC Target block.

xPC Target supports this board with these driver blocks:

- “PMC-16AO-12 Analog Output” on page 18-25

### Board Characteristics

|                                 |                   |
|---------------------------------|-------------------|
| Board name                      | PMC-16AO12        |
| Manufacturer                    | General Standards |
| Bus type                        | PCI               |
| Access method                   | Memory mapped     |
| Multiple block instance support | No                |
| Multiple board support          | Yes               |

## PMC-16AO-12 Analog Output

### Scaling Input to Output

The analog output range of this board depends on the output range that was chosen at the time of purchase. This range can be  $\pm 2.5$ ,  $\pm 5.0$ , or  $\pm 10.0$ .

| Hardware Output | Block Input Data Type | Scaling |
|-----------------|-----------------------|---------|
| volts           | Double                | 1       |

### Driver Block Parameters

**Channel vector** — Enter numbers between 1 and 12. This is a vector parameter that specifies the hardware output channels. For example, to produce output on channels 2 and 3, enter

[2 3]

All unspecified channels are set to 0.0 volts on output.

Number the channels beginning with 1 although the board manufacturer starts numbering the channels with 0.

**Reset vector** — The reset vector controls the behavior of the channel at model termination. Enter a scalar or a vector that is the same length as the channel vector. If you specify a scalar value, that setting is used for all channels. If you specify a value of 1, the corresponding channel is reset to the value specified in the initial value vector. If you specify a value of 0, the channel remains at the last value attained while the model was running. For example, if **Channel vector** is [ 2 3 ] and the **Reset vector** is [ 1 ], the action taken will be the same as if **Reset vector** was set to [ 1 1 ]. Both channels will be reset to their initial values when model execution is stopped.

**Initial value vector** — The initial value vector contains the initial voltage values for the output channels. Enter a scalar or a vector that is the same length as the channel vector. If you specify a scalar value, that value is the initial value for all channels. The channels are set to the initial values between the time the model is downloaded and the time it is started. When model execution is stopped, the corresponding position in **Reset vector** is checked. Depending on that value, the channel is either reset to the initial value or remains at the last value attained while the model was running. For example, assume that **Channel vector** is [ 2 5 8 ], **Reset vector** is [ 1 0 1 ], and **Initial value vector** is [ 2.3 5.6 0 ]. On initial download, channel 2 is set to 2.3 volts, channel 5 to 5.6 volts, and channel 8 to 0.0 volts. When the model is stopped, channel 2 resets to 2.3 volts, channel 5 remains at the last value attained, and channel 8 resets to 0.0 volts.

**Range** — From the list, choose either + -2.5, + -5.0, or + -10.0. The PMC-16AO-12 is specified at purchase time as having one of these three ranges. Choose the range to match that for which the board is configured.

Note that the range you set does not alter any configuration on the board. It is used to scale the signal when it is converted to a 16-bit value to be written to the output D/A converter (DAC).

**Autocalibration** — The PMC-16AO-12 can check its own calibration (autocalibration) against an internal voltage reference. Choose this check box to execute the autocalibration cycle when the model is downloaded to the xPC Target target PC. The calibration cycle takes several seconds to run. The output ports show a square wave during the cycle. The calibration cycle yields adjustment factors that are retained in onboard NVRAM. The PMC-16AO-12

reads these adjustment factors when the board is initialized. Refer to the PMC-16AO-12 documentation for further information on autocalibration.

**Ground sense** — Choose this check box to enable the hardware provided compensation for ground potential differences. Refer to the PMC-16AO-12 documentation for further information on ground sense.

**Sampletime** — Enter the base sample time or a multiple of the base sample time.

**PCI slot** — If only one board of this type is physically present in the target PC, enter

-1

to automatically locate the board.

If two or more boards of this type are physically present in the target PC, enter the bus number and the PCI slot number of the board associated with this driver block. Use the format [BusNumber, SlotNumber]. To determine the bus number and the PCI slot number, type

```
getxpcpci
```





# Humusoft

---

This chapter describes I/O boards supported by xPC Target  
(<http://www.humusoft.cz/datacq/index.htm>).

AD 512 (p. 19-2)

I/O board with 8 single analog input (A/D) channels, 2 analog output (D/A) channels, 8 digital inputs, and 8 digital outputs.

## AD 512

The AD 512 is an I/O board with 8 single analog input (A/D) channels (12-bit) with a maximum sample rate of 100 kHz, 2 analog output (D/A) channels (12-bit), 8 digital inputs, and 8 digital outputs.

xPC Target supports this board with these driver blocks:

- “AD 512 Analog Input (A/D)” on page 19-3
- “AD 512 Analog Output (D/A)” on page 19-4
- “AD 512 Digital Input” on page 19-5
- “AD 512 Digital Output” on page 19-6

### Board Characteristics

|                                 |               |
|---------------------------------|---------------|
| Board name                      | AD 512        |
| Manufacturer                    | Humusoft      |
| Bus type                        | ISA           |
| Access method                   | Memory mapped |
| Multiple block instance support | No            |
| Multiple board support          | Yes           |

## AD 512 Analog Input (A/D)

### Scaling Input to Output

| Hardware Input | Block Output Data Type | Scaling |
|----------------|------------------------|---------|
| volts          | Double                 | 1       |

### Driver block Parameter

**Channel vector** — Enter numbers between 1 and 8. This driver allows the selection of individual channels in any order. The number of elements defines the number of A/D channels used.

For example, to use the first, second and fifth channels, enter

[ 1, 2, 5 ]

Number the channels beginning with 1 even if the board manufacturer starts numbering the channels with 0.

**Range vector** — Enter a range code for each of the channels entered in the channel vector. The range vector must be the same length as the channel vector. This driver allows a different range for each channel.

The following table is a list of the ranges for this driver and the corresponding range codes.

| Input Range (V) | Range Code | Input Range (V) | Range Code |
|-----------------|------------|-----------------|------------|
| -10 to +10      | -10        | 0 - 10          | 10         |
| -5 to +5        | -5         | 0 - 5           | 5          |

For example, if the first channel is -10 to + 10 volts and the second and fifth channels are 0 to +1 volts, enter

[ -10, 1, 1 ]

**Sample time** — Model base sample time or a multiple of the base sample time.

**Base address** — Enter the base address of the board. This entry must correspond to the jumper settings on the board. For example, if the base address is 300 (hexadecimal), enter

0x300

## AD 512 Analog Output (D/A)

### Scaling Input to Output

| Hardware Output | Block Input Data Type | Scaling |
|-----------------|-----------------------|---------|
| volts           | Double                | 1       |

### Driver Block Parameters

**Channel vector** — This parameter is a combined Channel vector and Range vector. The number of elements defines the number of D/A channels used.

Enter a range code for each of the channels used. This driver allows a different range for each channel with a maximum of 2 channels.

The following table is a list of the ranges for this driver and the corresponding range codes.

| Input Range (V) | Range Code | Input Range (V) | Range Code |
|-----------------|------------|-----------------|------------|
| -10 to +10      | -10        | 0 - 10          | 10         |
| -5 to + 5       | -5         | 0 - 5           | 5          |

For example, if the first channel is -10 to + 10 volts and the second channel is 0 to +5 volts, enter

[-10,5]

**Sample time** — Enter the base sample time or a multiple of the base sample time.

**Base address** — Enter the base address of the board. This entry must correspond to the DIP-switch settings on the board. For example, if the base address is 300 (hexadecimal), enter

0x300

## AD 512 Digital Input

### Scaling Input to Output

| Hardware Input | Block Output Data Type | Scaling                         |
|----------------|------------------------|---------------------------------|
| TTL            | Double                 | TTL low = 0.0<br>TTL high = 1.0 |

**Channel vector** — Enter a numbers between 1 and 8. This driver allows the selection of individual digital line numbers in any order. The number of elements defines the number of digital input lines used.

For example, to use the first, second and fifth digital input lines, enter

[1,2,5]

Number the lines beginning with 1, even if the board manufacturer starts numbering the lines with 0.

**Sample time** — Enter the base sample time or a multiple of the base sample time.

**Base address** — Enter the base address of the board. This entry must correspond to the DIP-switch settings on the board. For example, if the base address is 300 (hexadecimal), enter

0x300

## AD 512 Digital Output

### Scaling Input to Output

| Hardware Output | Block Input Data Type | Scaling                             |
|-----------------|-----------------------|-------------------------------------|
| TTL             | Double                | < 0.5 = TTL low<br>≥ 0.5 = TTL high |

**Channel vector** — Enter a numbers between 1 and 8. This driver allows the selection of individual digital line numbers in any order. The number of elements defines the number of digital output lines used.

For example, to use the first, second and fifth digital output lines, enter

[1,2,5]

Number the lines beginning with 1, even if the board manufacturer starts numbering the lines with 0.

**Sample time** — Enter the base sample time or a multiple of the base sample time.

**Base address** — Enter the base address of the board. This entry must correspond to the DIP-switch settings on the board. For example, if the base address is 300 (hexadecimal), enter

0x300

# Keithley

---

This chapter describes I/O boards supported by xPC Target (<http://www.keithley.com>).

DAS-1800HR (p. 20-2)

I/O board with 16 single or 8 differential analog input (A/D) channels, 4 digital input lines and 4 digital output lines.

KCPI-1801HC (p. 20-7)

I/O board with 64 single or 32 differential analog input (A/D) channels, 2 analog output (D/A) channels, and 4 digital input and output lines.

KPCI-1802HC (p. 20-14)

I/O board with 64 single or 32 differential analog input (A/D) channels, 2 analog output (D/A) channels, and 4 digital input and output lines.

## DAS-1800HR

The DAS-1800HR is an I/O board with 16 single or 8 differential analog input (A/D) channels (16-bit) with a maximum sample rate of 100 kHz, 4 digital input lines and 4 digital output lines.

xPC Target supports this board with these driver blocks:

- “DAS-1800HR Analog Input (A/D)” on page 20-3
- “DAS-1800HR Digital Input” on page 20-5
- “DAS-1800HR Digital Output” on page 20-5

### Board Characteristics

|                                 |            |
|---------------------------------|------------|
| Board name                      | DAS-1800HR |
| Manufacturer                    | Keithley   |
| Bus type                        | ISA        |
| Access method                   | I/O mapped |
| Multiple block instance support | No         |
| Multiple board support          | Yes        |



## DAS-1800HR Analog Input (A/D)

### Scaling Input to Output

| Hardware Input | Block Output Data Type | Scaling |
|----------------|------------------------|---------|
| volts          | Double                 | 1       |

### Driver Block Parameters

**Channel vector** — If you select 16 channels (**Input coupling** parameter set to Single-ended channels or Single-ended common mode) enter numbers between 1 and 16 to select the number of individual channels used. If you select eight channels (**Input coupling** parameter set to Differential) enter numbers between 1 and 8 to select the A/D channels used. This driver allows the selection of individual A/D channels in any order. The number of elements defines the number of A/D channels used.

For example, to use the first, second and fifth channels, enter

```
[1,2,5]
```

Number the channels beginning with 1 even if the board manufacturer starts numbering the channels with 0.

**Gain vector (1,2,4,8)** — Enter 1, 2, 4, or 8 for each of the channels in the channel vector to choose the gain code of that channel. The gain vector must be the same length as the channel vector. This driver allows the gain of each channel to be different.

Notice that by increasing the gain code the voltage range is decreased. The gain divides the input voltage range.

For example, if the first channel has a gain code of 1 (10 volt range) and the second and fifth channels have a gain code of 2 (5 volt range), enter

```
[1,2,2]
```

**Range vector** — From the list, choose either Bipolar or Unipolar.

The range setting defines if the board is working in bipolar or unipolar input mode. This setting is the same for all of the selected channels.

The following table is a list of the ranges for this driver given the gain entered and the range chosen.

| <b>Gain</b> | <b>Bipolar Range (V)</b> | <b>Unipolar Range (V)</b> |
|-------------|--------------------------|---------------------------|
| 1           | -10 to +10               | 0 to 10                   |
| 2           | -5 to + 5                | 0 to +5                   |
| 4           | -2.5 to 2.5              | 0 to 2.5                  |
| 8           | -1.25 to +1.25           | 0 to 1.25                 |

**Input coupling** — From the list, select one from the following list of input modes:

- Differential (8 channels)
- Single-ended (16 channels)
- Single-ended common mode (16 channels)

This choice must correspond to the MUX-switch setting on the board.

Common-mode is similar to single-ended mode but the negative wire of the source to be measured is connected to input AI-SENSE instead of LLGND.

**Sample time** — Base sample time of a multiple of the base sample time.

**Base address** — Enter the base address of the board. It is important that this entry corresponds to the DIP-switch settings on the board. For example, if the base address is 300 (hexadecimal), enter

0x300

## DAS-1800HR Digital Input

### Scaling Input to Output

| Hardware Input | Block Output Data Type | Scaling                         |
|----------------|------------------------|---------------------------------|
| TTL            | Double                 | TTL low = 0.0<br>TTL high = 1.0 |

### Driver Block Parameters

**Number of channels** — Enter a number between 1 and 8 to select the number of digital input lines used with this port.

**Sample time** — Enter a base sample time or a multiple of the base sample time.

**Base address** — Enter the base address of the board. This entry must correspond to the DIP-switch settings on the board. For example, if the base address is 300 (hexadecimal), enter

0x300

## DAS-1800HR Digital Output

### Scaling Input to Output

| Hardware Output | Block Input Data Type | Scaling                             |
|-----------------|-----------------------|-------------------------------------|
| TTL             | Double                | < 0.5 = TTL low<br>≥ 0.5 = TTL high |

### Driver Block Parameters

**Number of channels** — Enter a number between 1 and 4 to select the number of digital output lines used with this port.

**Sample time** — Enter a base sample time or a multiple of the base sample time.

**Base address** — Enter the base address of the board. This entry must correspond to the DIP-switch settings on the board. For example, if the base address is 300 (hexadecimal), enter

0x300

## KCPI-1801HC

The KCPI-1801 is an I/O board with 64 single or 32 differential analog input (A/D) channels (12-bit) with a maximum sample rate of 333 kHz, 2 analog output (D/A) channels (12-bit), and 4 digital input and output lines.

xPC Target supports this board with these driver blocks:

- “KCPI-1801HC Analog Input (A/D)” on page 20-8
- “KCPI-1801HC Analog Output (D/A)” on page 20-10
- “KCPI-1801HC Digital Input” on page 20-11
- “KCPI-1801HC Digital Output” on page 20-12

xPC Target does not support the counter/timers on this board.

### Board Characteristics

|                                 |                                  |
|---------------------------------|----------------------------------|
| Board name                      | KCPI-1801HC                      |
| Manufacturer                    | Keithley Instruments             |
| Bus type                        | PCI                              |
| Access method                   | Memory mapped                    |
| Multiple block instance support | A/D:No, D/A:Yes, Digital I/O:Yes |
| Multiple board support          | Yes                              |

## KPCI-1801HC Analog Input (A/D)

### Scaling Input to Output

| Hardware Input | Block Output Data Type | Scaling |
|----------------|------------------------|---------|
| volts          | Double                 | 1       |

### Driver Block Parameters

**Channel vector** — Enter numbers between 1 and 64. This driver allows you to enter channel numbers in any order.

For example, to use the first, second and fifth channels, enter

[1,2,5]

Number the channels beginning with 1 even if the board manufacturer starts numbering the channels with 0.

**Range vector** — Enter a range code for each of the channels in the channel vector. The range vector must be the same length as the channel vector. This driver allows each channel to be different.

The following table is a list of the ranges for this driver and the corresponding range codes.

| Input Range (V) | Range Code | Input Range (V) | Range Code |
|-----------------|------------|-----------------|------------|
| -5 to +5        | -5         | 0 to 5          | 5          |
| -1 to +1        | -1         | 0 to 1          | 1          |
| -0.1 to +0.1    | -0.1       | 0 to 0.1        | 0.1        |
| -0.02 to +0.02  | -0.02      | 0 to 0.02       | 0.02       |

For example, if the first channel is -5 to + 5 volts and the second and fifth channels are 0 to +1 volts, enter

[-5,1,1]

**Input coupling vector** — Enter a coupling code for each of the channels in the channel vector. The coupling vector must be the same length as the channel vector. This driver allows a different coupling for each channel.

The following table is a list of the couplings for this driver and the corresponding coupling codes.

| <b>Coupling</b> | <b>Coupling Code</b> | <b>Description</b>                                                                                                                                               |
|-----------------|----------------------|------------------------------------------------------------------------------------------------------------------------------------------------------------------|
| single-ended    | 0                    | Analog input line connected to the positive input. Analog input ground (IGND) internally connected to the negative input.                                        |
| differential    | 1                    | First analog input line connected to the positive input of the PGIA. Second analog input line connected to the negative input of the PGIA. See the board manual. |

For example, if the first and second channels are single input and the fifth channel is a differential input, enter

```
[0,0,1]
```

The driver selects a second differential input 32 channels higher than the first channel. In the example above, the driver would select the 37th channel as a differential input with the fifth channel.

**Sample time** — Model base sample time or a multiple of the base sample time.

**PCI Slot (-1:autosearch)** — If only one board of this type is physically present in the target PC, enter

```
-1
```

to automatically locate the board.

If two or more boards of this type are physically present in the target PC, enter the bus number and the PCI slot number of the board associated with this driver block. Use the format [BusNumber, SlotNumber]. To determine the bus number and the PCI slot number, type

```
getxpcpci
```

## KPCI-1801HC Analog Output (D/A)

The analog output range of this board is set -10 to +10 volts.

### Scaling Input to Output

| Hardware Output | Block Input Data Type | Scaling |
|-----------------|-----------------------|---------|
| volts           | Double                | 1       |

### Driver Block Parameters

**Channel vector** — Enter numbers 1 or 2. This driver allows the selection of individual D/A channels in any order. The number of elements defines the number of D/A channels used. For example, to use both of the analog output channels, enter

[1,2]

Number the channels beginning with 1 even if the board manufacturer starts numbering the channels with 0.

**Reset vector** — The reset vector controls the behavior of the channel at model termination. Enter a scalar or a vector that is the same length as the channel vector. If you specify a scalar value, that setting is used for all channels. If you specify a value of 1, the corresponding channel is reset to the value specified in the initial value vector. If you specify a value of 0, the channel remains at the last value attained while the model was running.

**Initial value vector** — The initial value vector contains the initial voltage values for the output channels. Enter a scalar or a vector that is the same length as the channel vector. If you specify a scalar value, that value is the initial value for all channels. The channels are set to the initial values between the time the model is downloaded and the time it is started.

**Sample time** — Base sample time of a multiple of the base sample time.

**PCI Slot (-1:autosearch)** — If only one board of this type is physically present in the target PC, enter

-1

to automatically locate the board.



If two or more boards of this type are physically present in the target PC, enter the bus number and the PCI slot number of the board associated with this driver block. Use the format [BusNumber, SlotNumber]. To determine the bus number and the PCI slot number, type

```
getxpcpci
```

## KPCI-1801HC Digital Input

### Scaling Input to Output

| Hardware Input | Block Output Data Type | Scaling                         |
|----------------|------------------------|---------------------------------|
| TTL            | Double                 | TTL low = 0.0<br>TTL high = 1.0 |

### Driver Block Parameters

**Channel vector** — Enter numbers between 1 and 4 to select the digital input lines used with this port. This driver allows the selection of individual digital input lines in any order. The number of elements defines the number of digital lines used.

For example, to use all of the digital inputs for one port, enter

```
[1,2,3,4]
```

Number the lines beginning with 1 even if the board manufacturer starts numbering the lines with 0.

**Sample time** — Enter a base sample time or a multiple of the base sample time.

**PCI Slot (-1:autosearch)** — If only one board of this type is physically present in the target PC, enter

```
-1
```

to automatically locate the board.

If two or more boards of this type are physically present in the target PC, enter the bus number and the PCI slot number of the board associated with this driver block. Use the format [BusNumber, SlotNumber]. To determine the bus number and the PCI slot number, type

```
getxpcpci
```

## KPCI-1801HC Digital Output

### Scaling Input to Output

| Hardware Output | Block Input Data Type | Scaling                             |
|-----------------|-----------------------|-------------------------------------|
| TTL             | Double                | < 0.5 = TTL low<br>≥ 0.5 = TTL high |

### Driver Block Parameters

**Channel vector** — Enter numbers between 1 and 8 to select the digital output lines used with this port. This driver allows the selection of individual digital output lines in any order. The number of elements defines the number of digital lines used.

For example, to use all of the digital outputs for one port, enter

```
[1,2,3,4,5,6,7,8]
```

Number the lines beginning with 1 even if the board manufacturer starts numbering the lines with 0.

**Reset vector** — The reset vector controls the behavior of the channel at model termination. Enter a scalar or a vector that is the same length as the channel vector. If you specify a scalar value, that setting is used for all channels. If you specify a value of 1, the corresponding channel is reset to the value specified in the initial value vector. If you specify a value of 0, the channel remains at the last value attained while the model was running.

**Initial value vector** — The initial value vector contains the initial values (0 or 1) of the output channels. Enter a scalar or a vector that is the same length as the channel vector. If you enter a scalar, that value is used for all channels. The channels are set to these initial values between the time the model is downloaded and the time it is started.

**Sample time** — Enter a base sample time or a multiple of the base sample time.

**PCI Slot (-1:autosearch)** — If only one board of this type is physically present in the target PC, enter

-1

to automatically locate the board.

If two or more boards of this type are physically present in the target PC, enter the bus number and the PCI slot number of the board associated with this driver block. Use the format [BusNumber, SlotNumber]. To determine the bus number and the PCI slot number, type

`getxpcpci`

## KPCI-1802HC

The KPCI-1802 is an I/O board with 64 single or 32 differential analog input (A/D) channels (12-bit) with a maximum sample rate of 333 kHz, 2 analog output (D/A) channels (12-bit), and 4 digital input and output lines.

xPC Target supports this board with these driver blocks:

- “KPCI-1802HC Analog Input (A/D)” on page 20-15
- “KPCI-1802HC Analog Output (D/A)” on page 20-17
- “KPCI-1802HC Digital Input” on page 20-18
- “KPCI-1802HC Digital Output” on page 20-19

xPC Target does not support the counter/timers on this board.

### Board Characteristics

|                                 |                                  |
|---------------------------------|----------------------------------|
| Board name                      | KPCI-1802HC                      |
| Manufacturer                    | Keithley Instruments             |
| Bus type                        | PCI                              |
| Access method                   | Memory mapped                    |
| Multiple block instance support | A/D:No, D/A:Yes, Digital I/O:Yes |
| Multiple board support          | Yes                              |

## KPCI-1802HC Analog Input (A/D)

### Scaling Input to Output

| Hardware Input | Block Output Data Type | Scaling |
|----------------|------------------------|---------|
| volts          | Double                 | 1       |

### Driver Block Parameters

**Channel vector** — Enter numbers between 1 and 64. This driver allows you to enter channel numbers in any order.

For example, to use the first, second and fifth channels, enter

[ 1, 2, 5 ]

Number the channels beginning with 1 even if the board manufacturer starts numbering the channels with 0.

**Range vector** — Enter a range code for each of the channels in the channel vector. The range vector must be the same length as the channel vector. This driver allows each channel to be different.

The following table is a list of the ranges for this driver and the corresponding range codes.

| Input Range (V) | Range Code | Input Range (V) | Range Code |
|-----------------|------------|-----------------|------------|
| -10 to +10      | -10        | 0 to 10         | 10         |
| -5 to +5        | -5         | 0 to 5          | 5          |
| -2.5 to +2.5    | -2.5       | 0 to 2.5        | 2.5        |
| -1.25to +1.25   | -1.25      | 0 to 1.25       | 1.25       |

For example, if the first channel is -10 to + 10 volts and the second and fifth channels are 0 to +1 volts, enter

[ -10, 1, 1 ]

**Input coupling vector** — Enter a coupling code for each of the channels in the channel vector. The coupling vector must be the same length as the channel vector. This driver allows a different coupling for each channel.

The following table is a list of the couplings for this driver and the corresponding coupling codes.

| Coupling     | Coupling Code | Description                                                                                                                                                      |
|--------------|---------------|------------------------------------------------------------------------------------------------------------------------------------------------------------------|
| single-ended | 0             | Analog input line connected to the positive input. Analog input ground (IGND) internally connected to the negative input.                                        |
| differential | 1             | First analog input line connected to the positive input of the PGIA. Second analog input line connected to the negative input of the PGIA. See the board manual. |

For example, if the first and second channels are single input and the fifth channel is a differential input, enter

```
[0,0,1]
```

The driver selects a second differential input 32 channels higher than the first channel. In the example above, the driver would select the 37th channel as a differential input with the fifth channel.

**Sample time** — Model base sample time or a multiple of the base sample time.

**PCI Slot (-1:autosearch)** — If only one board of this type is physically present in the target PC, enter

```
-1
```

to automatically locate the board.

If two or more boards of this type are physically present in the target PC, enter the bus number and the PCI slot number of the board associated with this driver block. Use the format [BusNumber, SlotNumber]. To determine the bus number and the PCI slot number, type

```
getxpcpci
```

## KPCI-1802HC Analog Output (D/A)

The analog output range of this board is set -10 to +10 volts.

### Scaling Input to Output

| Hardware Output | Block Input Data Type | Scaling |
|-----------------|-----------------------|---------|
| volts           | Double                | 1       |

### Driver Block Parameters

**Channel vector** — Enter numbers 1 or 2. This driver allows the selection of individual D/A channels in any order. The number of elements defines the number of D/A channels used. For example, to use both of the analog output channels, enter

[ 1,2]

Number the channels beginning with 1 even if the board manufacturer starts numbering the channels with 0.

**Reset vector** — The reset vector controls the behavior of the channel at model termination. Enter a scalar or a vector that is the same length as the channel vector. If you specify a scalar value, that setting is used for all channels. If you specify a value of 1, the corresponding channel is reset to the value specified in the initial value vector. If you specify a value of 0, the channel remains at the last value attained while the model was running.

**Initial value vector** — The initial value vector contains the initial voltage values for the output channels. Enter a scalar or a vector that is the same length as the channel vector. If you specify a scalar value, that value is the initial value for all channels. The channels are set to the initial values between the time the model is downloaded and the time it is started.

**Sample time** — Base sample time of a multiple of the base sample time.

**PCI Slot (-1:autosearch)** — If only one board of this type is physically present in the target PC, enter

-1

to automatically locate the board.

If two or more boards of this type are physically present in the target PC, enter the bus number and the PCI slot number of the board associated with this driver block. Use the format [BusNumber, SlotNumber]. To determine the bus number and the PCI slot number, type

```
getxpcpci
```

## KPCI-1802HC Digital Input

### Scaling Input to Output

| Hardware Input | Block Output Data Type | Scaling                         |
|----------------|------------------------|---------------------------------|
| TTL            | Double                 | TTL low = 0.0<br>TTL high = 1.0 |

### Driver Block Parameters

**Channel vector** — Enter numbers between 1 and 4 to select the digital input lines used with this port. This driver allows the selection of individual digital input lines in any order. The number of elements defines the number of digital lines used.

For example, to use all of the digital inputs for one port, enter

```
[1,2,3,4]
```

Number the lines beginning with 1 even if the board manufacturer starts numbering the lines with 0.

**Sample time** — Enter a base sample time or a multiple of the base sample time.

**PCI Slot (-1:autosearch)** — If only one board of this type is physically present in the target PC, enter

```
-1
```

to automatically locate the board.



If two or more boards of this type are physically present in the target PC, enter the bus number and the PCI slot number of the board associated with this driver block. Use the format [BusNumber, SlotNumber]. To determine the bus number and the PCI slot number, type

```
getxpcpci
```

## KPCI-1802HC Digital Output

### Scaling Input to Output

| Hardware Output | Block Input Data Type | Scaling                             |
|-----------------|-----------------------|-------------------------------------|
| TTL             | Double                | < 0.5 = TTL low<br>≥ 0.5 = TTL high |

### Driver Block Parameters

**Channel vector** — Enter numbers between 1 and 8 to select the digital output lines used with this port. This driver allows the selection of individual digital output lines in any order. The number of elements defines the number of digital lines used.

For example, to use all of the digital outputs for one port, enter

```
[1,2,3,4,5,6,7,8]
```

Number the lines beginning with 1 even if the board manufacturer starts numbering the lines with 0.

**Reset vector** — The reset vector controls the behavior of the channel at model termination. Enter a scalar or a vector that is the same length as the channel vector. If you specify a scalar value, that setting is used for all channels. If you specify a value of 1, the corresponding channel is reset to the value specified in the initial value vector. If you specify a value of 0, the channel remains at the last value attained while the model was running.

**Initial value vector** — The initial value vector contains the initial values (0 or 1) of the output channels. Enter a scalar or a vector that is the same length as the channel vector. If you enter a scalar, that value is used for all channels. The channels are set to these initial values between the time the model is downloaded and the time it is started.

**Sample time** — Enter a base sample time or a multiple of the base sample time.

**PCI Slot (-1:autosearch)** — If only one board of this type is physically present in the target PC, enter

-1

to automatically locate the board.

If two or more boards of this type are physically present in the target PC, enter the bus number and the PCI slot number of the board associated with this driver block. Use the format [BusNumber, SlotNumber]. To determine the bus number and the PCI slot number, type

```
getxpcpci
```

# Measurement Computing (Formerly ComputerBoards)

---

I/O boards supported by xPC Target (<http://www.measurementcomputing.com>)

|                               |                                                                                                                                                            |
|-------------------------------|------------------------------------------------------------------------------------------------------------------------------------------------------------|
| CIO-CTR05 (p. 21-5)           | I/O board with 5 counter/timer channels.                                                                                                                   |
| CIO-CTR10 (p. 21-14)          | I/O board with 10 counter/timer channels.                                                                                                                  |
| CIO-DAC08 (/12) (p. 21-23)    | I/O board with 8 analog output (D/A) channels.                                                                                                             |
| CIO-DAC08/16 (p. 21-25)       | I/O board with 8 analog output (D/A) channels.                                                                                                             |
| CIO-DAC16 (/12) (p. 21-27)    | I/O board with 16 analog output (D/A) channels.                                                                                                            |
| CIO-DAC16/16 (p. 21-30)       | I/O board with 16 analog output (D/A) channels.                                                                                                            |
| CIO-DAS16/330 (p. 21-33)      | I/O board with 16 single or 8 differential analog input (A/D) channels, 4 digital input lines, and 4 digital output lines.                                 |
| CIO-DAS16/JR (/12) (p. 21-35) | I/O board with 16 single or 8 differential analog input (A/D) channels, 4 digital input lines, 4 digital output lines, and 3 counter/timers (16-bit).      |
| CIO-DAS16JR/16 (p. 21-40)     | I/O board with 16 single or 8 differential analog input (A/D) channels, 4 digital input lines, 4 digital output lines and 3 counter/timers.                |
| CIO-DAS1601/12 (p. 21-42)     | I/O board with 16 single or 8 differential analog input (A/D) channels, 2 analog output (D/A) channels, 32 digital input and output lines, and 3 counters. |
| CIO-DAS1602/12 (p. 21-49)     | I/O board with 16 single or 8 differential analog input (A/D) channels, 2 analog output (D/A) channels, 32 digital input and output lines, and 3 counters. |

|                               |                                                                                                                                               |
|-------------------------------|-----------------------------------------------------------------------------------------------------------------------------------------------|
| CIO-DAS1602/16 (p. 21-55)     | I/O board with 16 single or 8 differential analog input (A/D) channels, 2 analog output (D/A) channels, 32 digital I/O lines, and 3 counters. |
| CIO-DDA06 (/12) (p. 21-61)    | I/O board with 6 analog output (D/A) channels, and 24 digital I/O lines.                                                                      |
| CIO-DDA06/16 (p. 21-67)       | I/O board with 6 analog output (D/A) channels, and 24 digital I/O lines.                                                                      |
| CIO-DIO24 (p. 21-73)          | I/O board with 24 digital I/O lines.                                                                                                          |
| CIO-DIO24H (p. 21-77)         | I/O board with 24 digital I/O lines.                                                                                                          |
| CIO-DIO48 (p. 21-80)          | I/O board with 48 digital I/O lines.                                                                                                          |
| CIO-DIO48H (p. 21-84)         | I/O board with 48 digital I/O lines.                                                                                                          |
| CIO-DIO96 (p. 21-88)          | I/O board with 96 digital I/O lines.                                                                                                          |
| CIO-DIO192 (p. 21-92)         | I/O board with 192 digital I/O lines.                                                                                                         |
| CIO-DO24DD (p. 21-96)         | I/O board with 24 open-collector digital output lines.                                                                                        |
| CIO-PDISO16 (p. 21-98)        | I/O board with 16 isolated digital input lines and 16 relay driven digital output lines.                                                      |
| CIO-QUAD02 (p. 21-101)        | 24-bit counting board with 2 channels. This board typically connects to incremental encoders.                                                 |
| CIO-QUAD04 (p. 21-109)        | 24-bit counting board with 4 channels. This board typically connects to incremental encoders.                                                 |
| PC104-DAC06 (/12) (p. 21-117) | I/O board with 6 analog output (D/A) channels.                                                                                                |
| PC104-DAS16JR/12 (p. 21-119)  | I/O board with 16 single or 8 differential analog input channels, 4 digital input lines and 4 digital output lines.                           |
| PC104-DAS16JR/16 (p. 21-123)  | I/O board with 16 single or 8 differential analog input (A/D) channels, 4 digital input lines and 4 digital output lines.                     |
| PC104-DIO48 (p. 21-127)       | I/O board with 48 digital I/O lines.                                                                                                          |
| PCI-CTR05 (p. 21-131)         | I/O board with 5 counter/timer channels.                                                                                                      |

---

|                            |                                                                                                                                                               |
|----------------------------|---------------------------------------------------------------------------------------------------------------------------------------------------------------|
| PCI-DAS1200 (p. 21-141)    | I/O board with 16 single or 8 differential analog input (A/D) channels, 2 analog output (D/A) channels, and 24 digital input and output lines.                |
| PCI-DAS1200/JR (p. 21-148) | I/O board with 16 single or 8 differential analog input (A/D) channels, and 24 digital I/O lines.                                                             |
| PCI-DAS1602/12 (p. 21-153) | I/O board with 16 single or 8 differential analog input (A/D) channels, 2 analog output (D/A) channels, and 24 digital input and output lines and 3 counters. |
| PCI-DAS1602/16 (p. 21-160) | I/O board with 16 single or 8 differential analog input (A/D) channels, 2 analog output (D/A) channels, and 24 digital input and output lines and 3 counters. |
| PCI-DDA02/12 (p. 21-167)   | I/O board with 2 analog output (D/A) channels, and 48 digital I/O lines.                                                                                      |
| PCI-DDA02/16 (p. 21-173)   | I/O board with 2 analog output (D/A) channels, and 48 digital I/O lines.                                                                                      |
| PCI-DDA04/12 (p. 21-179)   | I/O board with 4 analog output (D/A) channels, and 48 digital I/O lines                                                                                       |
| PCI-DDA04/16 (p. 21-185)   | I/O board with 4 analog output (D/A) channels, and 48 digital I/O lines.                                                                                      |
| PCI-DDA08/12 (p. 21-191)   | I/O board with 8 analog output (A/D) channels, and 48 digital I/O lines.                                                                                      |
| PCI-DDA08/16 (p. 21-197)   | I/O board with 8 analog output (A/D) channels, and 48 digital I/O lines.                                                                                      |
| PCI-DIO24 (p. 21-203)      | I/O board with 24 digital I/O lines.                                                                                                                          |
| PCI-DIO24H (p. 21-207)     | I/O board with 24 digital I/O lines.                                                                                                                          |
| PCI-DIO48H (p. 21-211)     | I/O board with 48 digital I/O lines.                                                                                                                          |
| PCI-DIO96H (p. 21-215)     | I/O board with 96 digital I/O lines.                                                                                                                          |
| PCI-DIO96 (p. 21-219)      | I/O board with 96 digital I/O lines.                                                                                                                          |
| PCI-PDISO8 (p. 21-223)     | I/O board with eight inputs and eight relay outputs.                                                                                                          |
| PCI-PDISO16 (p. 21-226)    | I/O board with 16 inputs and 16 relay outputs.                                                                                                                |

|                             |                                                                                                                                                               |
|-----------------------------|---------------------------------------------------------------------------------------------------------------------------------------------------------------|
| PCIM-DAS1602/16 (p. 21-229) | I/O board with 16 single or 8 differential analog input (A/D) channels, 2 analog output (D/A) channels, and 24 digital input and output lines and 3 counters. |
| PCIM-DDA06/16 (p. 21-236)   | I/O board with 6 analog output (D/A) channels, and 24 digital I/O lines.                                                                                      |
| PCI-DUAL-AC5 (p. 21-242)    | I/O board with 48 digital I/O lines.                                                                                                                          |
| PCI-QUAD04 (p. 21-246)      | 24-bit counting board with 4 channels. This board typically connects to incremental encoders.                                                                 |
| PCI-DAS-TC (p. 21-254)      | I/O board with 16 differential analog thermocouple input channels. The thermocouple signals are converted by a high frequency synchronous V-F A/D converter.  |

## CIO-CTR05

The CIO-CTR05 is an I/O board with five counter/timer channels (16-bit).

It contains one AM9513A counter/timer chip. For additional information about the various counter/timer modes of that chip see the AM9513A data sheet which is part of the board documentation.

xPC Target supports this board with these driver blocks:

- “CIO-CTR05 Counter PWM” on page 21-6
- “CIO-CTR05 Counter PWM & ARM” on page 21-7
- “CIO-CTR05 Counter FM” on page 21-9
- “CIO-CTR05 Counter FM & ARM” on page 21-10
- “CIO-CTR05 PWM Capture” on page 21-12
- “CIO-CTR05 Frequency Capture” on page 21-13
- “CIO-CTRxx” on page 21-13

### Board Characteristics

|                                 |                |
|---------------------------------|----------------|
| Board name                      | CIO-CTR05      |
| Manufacturer                    | ComputerBoards |
| Bus type                        | ISA            |
| Access method                   | I/O mapped     |
| Multiple block instance support | Yes            |
| Multiple board support          | Yes            |

## CIO-CTR05 Counter PWM

The CIOCTR05 has one AM9513A chip with five counters.

The CIO-CTR05 PWM driver programs the AM9513A for PWM (Pulse Width Modulation) signal generation (a square wave with fixed frequency and variable duty cycle). The block has one input which defines the variable duty cycle between 0 and 1. For the corresponding counter channel, the PWM signal is output at the pin named OUT.

### Scaling Input to Output

| Hardware Output | Block Input Data Type | Scaling |
|-----------------|-----------------------|---------|
| TTL             | Double                | 0 to 1  |

### Driver Block Parameters

**Counter** — From the list, choose 1, 2, 3, 4, or 5 to select which counter is used with this driver block. In each case, one block is needed for each counter.

**Frequency base** — From the list, choose F1=5MHz, F2=500kHz, F3=50kHz, F4=5kHz, or F5=500Hz to set the base frequency. The XTAL frequency is assumed to be 1MHz, therefore the jumper on the CIO-CTR05 has to be in position 1MHz not 5MHz.

**Relative output frequency** — Enter a value between 0 and  $.25 \times \text{Frequency base}$ . The **Relative output frequency** is multiplied by the **Frequency base** to set the fixed output frequency of the PWM-signal.

For example, if the output frequency of a square wave has to be 17.5 kHz, then choose F2=100kHz as the **Frequency base** and enter 0.175 as the **Relative output frequency**.  $100\text{kHz} \times 0.175 = 17.5 \text{ kHz}$

**Level sequence of square wave** — From the list, choose either high-low or low-high:

- If you choose high-low, the square wave period starts with the TTL high part followed by the TTL low part.
- If you choose low-high, the square wave period starts with the TTL low part followed by the TTL high part.



In either case, the duty cycle entering the block defines the duration of the TTL high part.

**Level when disarmed** — From the list, choose either high or low. The counter is automatically disarmed when the target application is not running and gets armed when the application begins running. This parameter sets the TTL level when the counter is disarmed.

**Sample time** — Enter the base sample time or a multiple of the base sample time. The sample time indicates the update rate of registration on the input (Duty Cycle)

**Base address** — Enter the base address of the board. This entry must corresponds to the DIP switch settings on the board. For example, if the base address is 300 (hexadecimal), enter

0x300

## CIO-CTR05 Counter PWM & ARM

The CIO-CTR05 has one AM9513A chip with five counters.

The CIO-CTR05 PWM & ARM driver programs the AM9513A for PWM or disarmed signal generation (a square wave with fixed frequency and variable duty cycle). Additionally the driver allows to arm and disarm the counter by the second block input. For the corresponding counter channel, the PWM signal is output at the pin named OUT.

### Scaling Input to Output

| Hardware Output | Block Input Data Type             | Scaling                               |
|-----------------|-----------------------------------|---------------------------------------|
| TTL             | Duty cycle: Double<br>Arm: Double | 0 to 1<br><0.5 disarmed<br>≥0.5 armed |

### Driver Block Parameters

**Counter** — From the list, choose 1, 2, 3, 4, or 5 to select which counter is used with this driver block. In each case, one block is needed for each counter.

**Frequency base** — From the list, choose F1=5MHz, F2=500kHz, F3=50kHz, F4=5kHz, or F5=500Hz to set the base frequency. The XTAL frequency is assumed to be 1MHz, therefore the jumper on the CIO-CTR05 has to be in position 1MHz not 5MHz.

**Relative output frequency** — Enter a value between 0 and .25\***Frequency base**. The **Relative output frequency** is multiplied by the **Frequency base** to set the fixed output frequency of the PWM-signal.

For example, if the output frequency of a square wave has to be 17.5 kHz, then choose F2=100kHz as the **Frequency base** and enter 0.175 as the **Relative output frequency**.  $100\text{kHz} \times 0.175 = 17.5 \text{ kHz}$

**Level sequence of square wave** — From the list, choose either high-low or low-high:

- If you choose high-low, the square wave period starts with the TTL high part followed by the TTL low part.
- If you choose low-high, the square wave period starts with the TTL low part followed by the TTL high part.

In either case, the duty cycle entering the block defines the duration of the TTL high part.

**Level when disarmed** — From the list, choose either high or low. The counter is automatically disarmed when the target application is not running. If the application is running, the second input port controls whether the counter is armed or disarmed. This parameter sets the TTL level when the counter is disarmed.

**Sample time** — Enter the base sample time or a multiple of the base sample time. The sample time indicates the update rate of registration on the input (Duty Cycle)

**Base address** — Enter the base address of the board. This entry must corresponds to the DIP switch settings on the board. For example, if the base address is 300 (hexadecimal), enter

0x300

## CIO-CTR05 Counter FM

The CIO-CTR05 has one AM9513A chip with five counters.

The CIO-CTR05 FM driver programs the AM9513A for FM (Frequency Modulation) signal generation (a square wave with fixed duty cycle and variable frequency). For the corresponding counter channel, the PWM signal is output at the pin named OUT.

### Scaling Input to Output

| Hardware Output | Block Input Data Type | Scaling |
|-----------------|-----------------------|---------|
| TTL             | Double                | 0 to 1  |

### Driver Block Parameters

**Counter** — From the list, choose 1, 2, 3, 4, or 5 to select which counter is used with this driver block. In each case, one block is needed for each counter.

**Frequency base** — From the list, choose F1=5MHz, F2=500kHz, F3=50kHz, F4=5kHz, or F5=500Hz to set the base frequency. The XTAL frequency is assumed to be 1MHz, therefore the jumper on the CIO-CTR05 has to be in position 1MHz not 5MHz.

**Output duty cycle** — Enter a value between 0 and 1 to set the duty cycle of the square wave. The Duty Cycle is held fixed during execution of the target application.

---

**Note** Your control over the output duty cycle is not always precise. See “PWM and FM Driver Block Notes” on page 1-8 for details.

---

**Level sequence of square wave** — From the list, choose either high-low or low-high:

- If you choose high-low, the square wave period starts with the TTL high part followed by the TTL low part.
- If you choose low-high, the square wave period starts with the TTL low part followed by the TTL high part.

In either case, the duty cycle entering the block defines the duration of the TTL high part.

**Level when disarmed** — From the list, choose either high or low. The counter is automatically disarmed when the target application is not running and gets armed when the application begins running. This parameter sets the TTL level when the counter is disarmed.

**Sample time** — Enter the base sample time or a multiple of the base sample time. The sample time indicates the update rate of registration on the input (Duty Cycle)

**Base address** — Enter the base address of the board. This entry must corresponds to the DIP switch settings on the board. For example, if the base address is 300 (hexadecimal), enter

0x300

## CIO-CTR05 Counter FM & ARM

The CIO-CTR05 has one AM9513A chip with five counters.

The CIO-CTR05 FM & ARM driver programs the AM9513A for FM (Frequency Modulation) signal generation (a square wave with fixed duty cycle and variable frequency). Additionally the driver allows to arm and disarm the counter by the second block input. For the corresponding counter channel, the PWM signal is output at the pin named OUT.

### Scaling Input to Output

| Hardware Output | Block Input Data Type                     | Scaling                     |
|-----------------|-------------------------------------------|-----------------------------|
| TTL             | Variable frequency: Double<br>Arm: Double | <0.5 disarmed<br>≥0.5 armed |

### Driver Block Parameters

**Counter** — From the list, choose 1, 2, 3, 4 or, 5 to select which counter is used with this driver block. In each case, one block is needed for each counter.

**Frequency base** — From the list, choose F1=5MHz, F2=500kHz, F3=50kHz, F4=5kHz, or F5=500Hz to set the base frequency. The XTAL frequency is assumed to be 1MHz, therefore the jumper on the CIO-CTR05 has to be in position 1MHz not 5MHz.

**Output duty cycle** — Enter a value between 0 and 1 to set the duty cycle of the square wave. The Duty Cycle is held fixed during execution of the target application.

---

**Note** Your control over the output duty cycle is not always precise. See “PWM and FM Driver Block Notes” on page 1-8 for details.

---

**Level sequence of square wave** — From the list, choose either high-low or low-high:

- If you choose high-low, the square wave period starts with the TTL high part followed by the TTL low part.
- If you choose low-high, the square wave period starts with the TTL low part followed by the TTL high part.

In either case, the **Output duty cycle** defined in the setting above define the duration of the TTL high part.

**Level when disarmed** — From the list, choose either high or low. The counter is automatically disarmed when the target application is not running. If the application is running, the second input port controls whether the counter is armed or disarmed. This parameter sets the TTL level when the counter is disarmed.

**Sample time** — Enter the base sample time or a multiple of the base sample time. The sample time indicates the update rate of registration on the input (Duty Cycle)

**Base address** — Enter the base address of the board. This entry must corresponds to the DIP switch settings on the board. For example, if the base address is 300 (hexadecimal), enter

0x300

## CIO-CTR05 PWM Capture

This block programs the AMD9513A for capturing PWM signals by using two counters. One counter measures the cycle duration, and the other counter measures the duration the signal is high.

There are two outputs. One output is the relative frequency compared to the base frequency. The other output is the duty cycle. To get the actual frequency, multiply the base frequency by the relative frequency.

The PWM signal has to enter the pins named GATE of both corresponding counter channels (parallel wiring). Both CLK pins have to be left unconnected.

### Scaling Input to Output

| Hardware Output | Block Input Data Type | Scaling |
|-----------------|-----------------------|---------|
| TTL             | Double                | 0 to 1  |

### Driver Block Parameters

**Counter** — From the list, choose 1&2, 2&3, 3&4, 4&5. This selects which two counters the driver block uses to determine the PWM. In each case, one block is needed for each counter.

**Frequency base** — From the list, choose F1=5MHz, F2=500kHz, F3=50kHz, F4=5kHz, or F5=500Hz to set the base frequency. The XTAL frequency is assumed to be 1MHz, therefore the jumper on the CIO-CTR05 has to be in position 1MHz not 5MHz.

**Sample time** — Enter the base sample time or a multiple of the base sample time. The sample time indicates the update rate of registration on the input (Duty Cycle)

**Base address** — Enter the base address of the board. This entry must corresponds to the DIP switch settings on the board. For example, if the base address is 300 (hexadecimal), enter

0x300

## CIO-CTR05 Frequency Capture

This block programs the AMD9513A for capturing FM signals.

There is one output for relative frequency compared to the base frequency. To get the actual frequency, multiply the base frequency by the relative frequency.

The FM signal has to enter the pin named GATE of the corresponding counter channel. The CLK pin has to be left unconnected.

### Scaling Input to Output

| Hardware Output | Block Input Data Type | Scaling |
|-----------------|-----------------------|---------|
| TTL             | Double                | 0 to 1  |

### Driver Block Parameters

**Counter** — From the list, choose 1, 2, 3, 4, or 5. This selects which counter the driver block uses to determine the FM. In each case, one block is needed for each counter.

**Frequency base** — From the list, choose F1=5MHz, F2=500kHz, F3=50kHz, F4=5kHz, or F5=500Hz to set the base frequency. The XTAL frequency is assumed to be 1MHz, therefore the jumper on the CIO-CTR05 has to be in position 1MHz not 5MHz.

**Sample time** — Enter the base sample time or a multiple of the base sample time. The sample time indicates the update rate of registration on the input (Duty Cycle)

**Base address** — Enter the base address of the board. This entry must corresponds to the DIP switch settings on the board. For example, if the base address is 300 (hexadecimal), enter

0x300

## CIO-CTRxx

You can use this block to program the AMD9513A counter. The PWM, PWM & ARM, FM, FM & ARM, PWM Capture, and Frequency Capture blocks use this block in their underlying subsystems. The API for this block is not currently documented.

## CIO-CTR10

The CIO-CTR10 is an I/O board with ten counter/timer channels (16-bit).

It contains one AM9513A counter/timer chip. For additional information about the various counter/timer modes of that chip see the AM9513A data sheet which is part of the board documentation.

xPC Target supports this board with these driver blocks:

- “CIO-CTR10 Counter PWM” on page 21-15
- “CIO-CTR10 Counter PWM & ARM” on page 21-16
- “CIO-CTR10 Counter FM” on page 21-18
- “CIO-CTR10 Counter FM & ARM” on page 21-19
- “CIO-CTR10 PWM Capture” on page 21-21
- “CIO-CTR10 Frequency Capture” on page 21-22
- “CIO-CTRxx” on page 21-22

### Board Characteristics

|                                 |                |
|---------------------------------|----------------|
| Board name                      | CIO-CTR05      |
| Manufacturer                    | ComputerBoards |
| Bus type                        | ISA            |
| Access method                   | I/O mapped     |
| Multiple block instance support | Yes            |
| Multiple board support          | Yes            |



## CIO-CTR10 Counter PWM

The CIOCTR10 has one AM9513A chip with ten counters.

The CIO-CTR10 PWM driver programs the AM9513A for PWM (Pulse Width Modulation) signal generation (a square wave with fixed frequency and variable duty cycle). The block has one input which defines the variable duty cycle between 0 and 1. For the corresponding counter channel, the PWM signal is output at the pin named OUT.

### Scaling Input to Output

| Hardware Output | Block Input Data Type | Scaling |
|-----------------|-----------------------|---------|
| TTL             | Double                | 0 to 1  |

### Driver Block Parameters

**Counter** — From the list, choose 1, 2, 3, 4, or 5 to select which counter is used with this driver block. In each case, one block is needed for each counter.

**Frequency base** — From the list, choose F1=1MHz, F2=100kHz, F3=10kHz, F4=1kHz, or F5=100Hz to set the base frequency. The XTAL frequency is assumed to be 1MHz, therefore the jumper on the CIO-CTR05 has to be in position 1MHz not 5MHz.

**Relative output frequency** — Enter a value between 0 and  $.25 \times \text{Frequency base}$ . The **Relative output frequency** is multiplied by the **Frequency base** to set the fixed output frequency of the PWM-signal.

For example, if the output frequency of a square wave has to be 17.5 kHz, then choose F2=100kHz as the **Frequency base** and enter 0.175 as the **Relative output frequency**.  $100\text{kHz} \times 0.175 = 17.5\text{ kHz}$

**Level sequence of square wave** — From the list, choose either high-low or low-high:

- If you choose high-low, the square wave period starts with the TTL high part followed by the TTL low part.
- If you choose low-high, the square wave period starts with the TTL low part followed by the TTL high part.

In either case, the duty cycle entering the block defines the duration of the TTL high part.

**Level when disarmed** — From the list, choose either high or low. The counter is automatically disarmed when the target application is not running and gets armed when the application begins running. This parameter sets the TTL level when the counter is disarmed.

**Sample time** — Enter the base sample time or a multiple of the base sample time. The sample time indicates the update rate of registration on the input (Duty Cycle)

**Base address** — Enter the base address of the board. This entry must corresponds to the DIP switch settings on the board. For example, if the base address is 300 (hexadecimal), enter

0x300

## CIO-CTR10 Counter PWM & ARM

The CIO-CTR10 has two AM9513A chip with ten counters.

The CIO-CTR10 PWM & ARM driver programs the AM9513A for PWM or disarmed signal generation (a square wave with fixed frequency and variable duty cycle). Additionally the driver allows to arm and disarm the counter by the second block input. For the corresponding counter channel, the PWM signal is output at the pin named OUT.

### Scaling Input to Output

| Hardware Output | Block Input Data Type             | Scaling                               |
|-----------------|-----------------------------------|---------------------------------------|
| TTL             | Duty cycle: Double<br>Arm: Double | 0 to 1<br><0.5 disarmed<br>≥0.5 armed |

## Driver Block Parameters

**Counter** — From the list, choose 1, 2, 3, 4, or 5 to select which counter is used with this driver block. In each case, one block is needed for each counter.

**Frequency base** — From the list, choose F1=1MHz, F2=100kHz, F3=10kHz, F4=1kHz, or F5=100Hz to set the base frequency. The XTAL frequency is assumed to be 1MHz, therefore the jumper on the CIO-CTR05 has to be in position 1MHz not 5MHz.

**Relative output frequency** — Enter a value between 0 and  $.25 \times \text{Frequency base}$ . The **Relative output frequency** is multiplied by the **Frequency base** to set the fixed output frequency of the PWM-signal.

For example, if the output frequency of a square wave has to be 17.5 kHz, then choose F2=100kHz as the **Frequency base** and enter 0.175 as the **Relative output frequency**.  $100\text{kHz} \times 0.175 = 17.5 \text{ kHz}$

**Level sequence of square wave** - From the list, choose either high-low or low-high:

- If you choose high-low, the square wave period starts with the TTL high part followed by the TTL low part.
- If you choose low-high, the square wave period starts with the TTL low part followed by the TTL high part.

In either case, the duty cycle entering the block defines the duration of the TTL high part.

**Level when disarmed** — From the list, choose either high or low. The counter is automatically disarmed when the target application is not running. If the application is running, the second input port controls whether the counter is armed or disarmed. This parameter sets the TTL level when the counter is disarmed.

**Sample time** — Enter the base sample time or a multiple of the base sample time. The sample time indicates the update rate of registration on the input (Duty Cycle)

**Base address** — Enter the base address of the board. This entry must corresponds to the DIP switch settings on the board. For example, if the base address is 300 (hexadecimal), enter

0x300

## CIO-CTR10 Counter FM

The CIO-CTR10 has two AM9513A chip with ten counters.

The CIO-CTR05 FM driver programs the AM9513A for FM (Frequency Modulation) signal generation (a square wave with fixed duty cycle and variable frequency). For the corresponding counter channel, the PWM signal is output at the pin named OUT.

### Scaling Input to Output

| Hardware Output | Block Input Data Type | Scaling |
|-----------------|-----------------------|---------|
| TTL             | Double                | 0 to 1  |

### Driver Block Parameters

**Counter** — From the list, choose 1, 2, 3, 4, or 5 to select which counter is used with this driver block. In each case, one block is needed for each counter.

**Frequency base** — From the list, choose F1=1MHz, F2=100kHz, F3=10kHz, F4=1kHz, or F5=100Hz to set the base frequency. XTAL frequency is assumed to be 1MHz, therefore the jumper on the CIO-CTR05 has to be in position 1MHz not 5MHz.

**Output duty cycle** — Enter a value between 0 and 1 to set the duty cycle of the square wave. The Duty Cycle is held fixed during execution of the target application.

---

**Note** Your control over the output duty cycle is not always precise. See “PWM and FM Driver Block Notes” on page 1-8 for details.

---

**Level sequence of square wave** — From the list, choose either high-low or low-high:

- If you choose high-low, the square wave period starts with the TTL high part followed by the TTL low part.
- If you choose low-high, the square wave period starts with the TTL low part followed by the TTL high part.

In either case, the duty cycle entering the block defines the duration of the TTL high part.

**Level when disarmed** — From the list, choose either high or low. The counter is automatically disarmed when the target application is not running and gets armed when the application begins running. This parameter sets the TTL level when the counter is disarmed.

**Sample time** — Enter the base sample time or a multiple of the base sample time. The sample time indicates the update rate of registration on the input (Duty Cycle)

**Base address** — Enter the base address of the board. This entry must corresponds to the DIP switch settings on the board. For example, if the base address is 300 (hexadecimal), enter

0x300

## CIO-CTR10 Counter FM & ARM

The CIO-CTR10 has two AM9513A chips with ten counters.

The CIO-CTR10 FM & ARM driver programs the AM9513A for FM (Frequency Modulation) signal generation (a square wave with fixed duty cycle and variable frequency). Additionally the driver allows to arm and disarm the counter by the second block input. For the corresponding counter channel, the PWM signal is output at the pin named OUT.

### Scaling Input to Output

| Hardware Output | Block Input Data Type                     | Scaling                     |
|-----------------|-------------------------------------------|-----------------------------|
| TTL             | Variable frequency: Double<br>Arm: Double | <0.5 disarmed<br>≥0.5 armed |

### Driver Block Parameters

**Counter** — From the list, choose 1, 2, 3, 4, 5, 6, 7, 8, 9, or 10 to select which counter is used with this driver block. In each case, one block is needed for each counter.

**Frequency base** — From the list, choose F1=1MHz, F2=100kHz, F3=10kHz, F4=1kHz, or F5=100Hz to set the base frequency. The XTAL frequency is assumed to be 1MHz, therefore the jumper on the CIO-CTR05 has to be in position 1MHz not 5MHz.

**Output duty cycle** — Enter a value between 0 and 1 to set the duty cycle of the square wave. The Duty Cycle is held fixed during execution of the target application.

---

**Note** Your control over the output duty cycle is not always precise. See “PWM and FM Driver Block Notes” on page 1-8 for details.

---

**Level sequence of square wave** — From the list, choose either high-low or low-high:

- If you choose high-low, the square wave period starts with the TTL high part followed by the TTL low part.
- If you choose low-high, the square wave period starts with the TTL low part followed by the TTL high part.

In either case, the **Output duty cycle** defined in the setting above define the duration of the TTL high part.

**Level when disarmed** — From the list, choose either high or low. The counter is automatically disarmed when the target application is not running. If the application is running, the second input port controls whether the counter is armed or disarmed. This parameter sets the TTL level when the counter is disarmed.

**Sample time** — Enter the base sample time or a multiple of the base sample time. The sample time indicates the update rate of registration on the input (Duty Cycle)

**Base address** — Enter the base address of the board. This entry must corresponds to the DIP switch settings on the board. For example, if the base address is 300 (hexadecimal), enter

0x300

## CIO-CTR10 PWM Capture

This block programs the AMD9513A for capturing PWM signals by using two counters. One counter measures the cycle duration, and the other counter measures the duration the signal is high.

There are two outputs. One output is the relative frequency compared to the base frequency. The other output is the duty cycle. To get the actual frequency, multiply the base frequency by the relative frequency.

The PWM signal has to enter the pins named GATE of both corresponding counter channels (parallel wiring). Both CLK pins have to be left unconnected.

### Scaling Input to Output

| Hardware Output | Block Input Data Type | Scaling |
|-----------------|-----------------------|---------|
| TTL             | Double                | 0 to 1  |

### Driver Block Parameters

**Counter** - From the list, choose 1&2, 2&3, 3&4, 4&5, 5&6, 6&7, 7&8, 8&9, 9&10. This selects which two counters the driver block uses to determine the PWM. In each case, one block is needed for each counter.

**Frequency base** - From the list, choose F1=1MHz, F2=100kHz, F3=10kHz, F4=1kHz, or F5=100Hz to set the base frequency. The XTAL frequency is assumed to be 1MHz, therefore the jumper on the CIO-CTR10 has to be in position 1MHz not 5MHz.

**Sample time** - Enter the base sample time or a multiple of the base sample time. The sample time indicates the update rate of registration on the input (Duty Cycle)

**Base address** - Enter the base address of the board. This entry must corresponds to the DIP switch settings on the board. For example, if the base address is 300 (hexadecimal), enter

0x300

## CIO-CTR10 Frequency Capture

This block programs the AMD9513A for capturing FM signals.

There is one output for relative frequency compared to the base frequency. To get the actual frequency, multiply the base frequency by the relative frequency.

The FM signal has to enter the pin named GATE of the corresponding counter channel. The CLK pin has to be left unconnected.

### Scaling Input to Output

| Hardware Output | Block Input Data Type | Scaling |
|-----------------|-----------------------|---------|
| TTL             | Double                | 0 to 1  |

### Driver Block Parameters

**Counter** — From the list, choose 1, 2, 3, 4, 5, 6, 7, 8, 9, or 10. This selects which counter the driver block uses to determine the FM. In each case, one block is needed for each counter.

**Frequency base** — From the list, choose F1=1MHz, F2=100kHz, F3=10kHz, F4=1kHz, or F5=100Hz to set the base frequency. The XTAL frequency is assumed to be 1MHz, therefore the jumper on the CIO-CTR10 has to be in position 1MHz not 5MHz.

**Sample time** — Enter the base sample time or a multiple of the base sample time. The sample time indicates the update rate of registration on the input (Duty Cycle)

**Base address** — Enter the base address of the board. This entry must corresponds to the DIP switch settings on the board. For example, if the base address is 300 (hexadecimal), enter

0x300

### CIO-CTRxx

You can use this block to program the AMD9513A counter. The PWM, PWM & ARM, FM, FM & ARM, PWM Capture, and Frequency Capture blocks use this block in their underlying subsystems. The API for this block is not currently documented.



## CIO-DAC08 (/12)

The CIO-DAC08 (/12) is an I/O board with eight analog output (D/A) channels (12-bit).

xPC Target supports this board with this driver block:

- “CIO-DAC08 Analog Output (D/A)” on page 21-23

### Board Characteristics

|                                 |                          |
|---------------------------------|--------------------------|
| Board name                      | CIO-DAC08 (CIO-DAC08/12) |
| Manufacturer                    | ComputerBoards           |
| Bus type                        | ISA                      |
| Access method                   | I/O mapped               |
| Multiple block instance support | Yes                      |
| Multiple board support          | Yes                      |

### CIO-DAC08 Analog Output (D/A)

#### Scaling Input to Output

| Hardware Output | Block Input Data Type | Scaling |
|-----------------|-----------------------|---------|
| volts           | Double                | 1       |

#### Driver Block Parameters

**Channel vector** — Enter numbers between 1 and 8. This board allows the selection of individual D/A channels in any order. The number of elements defines the number of D/A channels used. For example, to use the first and second analog output (D/A) channels, enter

[1,2]

Number the channels beginning with 1 even if the board manufacturer starts numbering the channels with 0.

**Range vector** — Range code for each of the channels in the channel vector. The range vector must have the same length as the channel vector. This board allows the range of each channel to be different.

The following table is a list of the ranges for this driver and the corresponding range codes.

| Input Range (V) | Range Code | Input Range (V) | Range Code |
|-----------------|------------|-----------------|------------|
| -10 to +10      | -10        | 0 - 10          | 10         |
| -5 to +5        | -5         | 0 - 5           | 5          |

For example, if the first channel is -10 to +10 volts, and the second channel is 0 to 5 volts, enter

[ -10,5]

The range settings have to correspond to the DIP switch settings on the board.

**Reset vector** — The reset vector controls the behavior of the channel at model termination. Enter a scalar or a vector that is the same length as the channel vector. If you specify a scalar value, that setting is used for all channels. If you specify a value of 1, the corresponding channel is reset to the value specified in the initial value vector. If you specify a value of 0, the channel remains at the last value attained while the model was running.

**Initial value vector** — The initial value vector contains the initial voltage values for the output channels. Enter a scalar or a vector that is the same length as the channel vector. If you specify a scalar value, that value is the initial value for all channels. The channels are set to the initial values between the time the model is downloaded and the time it is started.

**Sample time** — Base sample time of a multiple of the base sample time.

**Base address** — Enter the base address of the board. It is important that this entry corresponds to the DIP switch settings on the board. For example, if the base address is 300 (hexadecimal), enter

0x300

## CIO-DAC08/16

The CIO-DAC08/16 is an I/O board with 8 analog output (D/A) channels (16-bit).

xPC Target supports this board with this driver block:

- “CIO-DAC08/16 Analog Output (D/A)” on page 21-25

### Board Characteristics

|                                 |                |
|---------------------------------|----------------|
| Board name                      | CIO-DAC08/16   |
| Manufacturer                    | ComputerBoards |
| Bus type                        | ISA            |
| Access method                   | I/O mapped     |
| Multiple block instance support | Yes            |
| Multiple board support          | Yes            |

## CIO-DAC08/16 Analog Output (D/A)

### Scaling Input to Output

| Hardware Output | Block Input Data Type | Scaling |
|-----------------|-----------------------|---------|
| volts           | Double                | 1       |

### Driver Block Parameters

**Channel vector** — Enter numbers between 1 and 8. This board allows the selection of individual D/A channels in any order. The number of elements defines the number of D/A channels used. For example, to use the first and second analog output (D/A) channels, enter

[1,2]

Number the channels beginning with 1 even if the board manufacturer starts numbering the channels with 0.

**Range vector** — Range code for each of the channels in the channel vector. The range vector must be the same length as the channel vector. This driver allows the range of each channel to be different.

The following table is a list of the ranges for this driver and the corresponding range codes.

| Input Range (V) | Range Code | Input Range (V) | Range Code |
|-----------------|------------|-----------------|------------|
| -10 to +10      | -10        | 0 - 10          | 10         |
| -5 to +5        | -5         | 0 - 5           | 5          |

For example, if the first channel is -10 to +10 volts, and the second channel is 0 to 5 volts, enter

```
[-10,5]
```

The range settings have to correspond to the DIP switch settings on the board.

**Reset vector** — The reset vector controls the behavior of the channel at model termination. Enter a scalar or a vector that is the same length as the channel vector. If you specify a scalar value, that setting is used for all channels. If you specify a value of 1, the corresponding channel is reset to the value specified in the initial value vector. If you specify a value of 0, the channel remains at the last value attained while the model was running.

**Initial value vector** — The initial value vector contains the initial voltage values for the output channels. Enter a scalar or a vector that is the same length as the channel vector. If you specify a scalar value, that value is the initial value for all channels. The channels are set to the initial values between the time the model is downloaded and the time it is started.

**Sample time** — Base sample time of a multiple of the base sample time.

**Base address** — Enter the base address of the board. It is important that this entry corresponds to the DIP switch settings on the board. For example, if the base address is 300 (hexadecimal), enter

```
0x300
```

## CIO-DAC16 (/12)

The CIO-DAC016 is an I/O board with 16 analog output (D/A) channels (12-bit).  
xPC Target supports this board with one driver block:

- “CIO-DAC16/16 Analog Output (D/A)” on page 21-30

### Board Characteristics

|                                 |                 |
|---------------------------------|-----------------|
| Board name                      | CIO-DAC16 (/12) |
| Manufacturer                    | ComputerBoards  |
| Bus type                        | ISA             |
| Access method                   | I/O mapped      |
| Multiple block instance support | Yes             |
| Multiple board support          | Yes             |

### CIO-DAC16 Analog Output (D/A)

#### Scaling Input to Output

| Hardware Output | Block Input Data Type | Scaling |
|-----------------|-----------------------|---------|
| volts           | Double                | 1       |

#### Driver Block Parameters

**Channel vector** — Enter numbers between 1 and 16. This driver allows the selection of individual D/A channels in any order. The number of elements defines the number of D/A channels used. For example, to use the first and second analog output (D/A) channels, enter

[1,2]

Number the channels beginning with 1 even if the board manufacturer starts numbering the channels with 0.

**Range vector** — Enter a range code for each of the channels in the channel vector. The range vector must be the same length as the channel vector. This board allows the range of each channel to be different.

The following table is a list of the ranges for this driver and the corresponding range codes.

| Input Range (V) | Range Code | Input Range (V) | Range Code |
|-----------------|------------|-----------------|------------|
| -10 to +10      | -10        | 0 - 10          | 10         |
| -5 to +5        | -5         | 0 - 5           | 5          |
| -2.5 to +2.5    | -2.5       | 0 to 2.5        | 2.5        |

For example, if the first channel is -10 to +10 volts, and the second channel is 0 to 5 volts, enter

[ -10,5]

The range settings have to correspond to the DIP switch settings on the board.

**Reset vector** — The reset vector controls the behavior of the channel at model termination. Enter a scalar or a vector that is the same length as the channel vector. If you specify a scalar value, that setting is used for all channels. If you specify a value of 1, the corresponding channel is reset to the value specified in the initial value vector. If you specify a value of 0, the channel remains at the last value attained while the model was running.

**Initial value vector** — The initial value vector contains the initial voltage values for the output channels. Enter a scalar or a vector that is the same length as the channel vector. If you specify a scalar value, that value is the initial value for all channels. The channels are set to the initial values between the time the model is downloaded and the time it is started.

**Sample time** — Base sample time of a multiple of the base sample time.

**Base address** — Enter the base address of the board. It is important that this entry corresponds to the DIP switch settings on the board. For example, if the base address is 300 (hexadecimal), enter

0x300

The jumpers by the range DIP switches on the board all have to be in the XFER position. The Wait-State jumper has to be in the off position.

## CIO-DAC16/16

The CIO-DAC16/16 is an I/O board with 16 analog output (D/A) channels (16-bit).

xPC Target supports this board with this driver block:

- “CIO-DAC16/16 Analog Output (D/A)” on page 21-30

### Board Characteristics

|                                 |                |
|---------------------------------|----------------|
| Board name                      | CIO-DAC08/16   |
| Manufacturer                    | ComputerBoards |
| Bus type                        | ISA            |
| Access method                   | I/O mapped     |
| Multiple block instance support | Yes            |
| Multiple board support          | Yes            |

## CIO-DAC16/16 Analog Output (D/A)

### Scaling Input to Output

| Hardware Output | Block Input Data Type | Scaling |
|-----------------|-----------------------|---------|
| volts           | Double                | 1       |

### Driver Block Parameters

**Channel vector** — Enter numbers between 1 and 16. This board allows the selection of individual A/D channels in any order. The number of elements defines the number of D/A channels used. For example, to use the first and second analog output (D/A) channels, enter

[1,2]

Number the channels beginning with 1 even if the board manufacturer starts numbering the channels with 0.



**Range vector** — Enter a range code for each of the channels in the channel vector. The range vector must be the same length as the channel vector. This board allows the range of each channel to be different.

The following table is a list of the ranges for this driver and the corresponding range codes.

| Input range (V) | Range code | Input range (V) | Range code |
|-----------------|------------|-----------------|------------|
| -10 to +10      | -10        | 0 - 10          | 10         |
| -5 to +5        | -5         | 0 - 5           | 5          |
| -2.5 to +2.5    | -2.5       | 0 to 2.5        | 2.5        |

For example, if the first channel is -10 to +10 volts, and the second channel is 0 to 5 volts, enter

[ -10,5]

The range settings have to correspond to the DIP switch settings on the board.

**Reset vector** – The reset vector controls the behavior of the channel at model termination. Enter a scalar or a vector that is the same length as the channel vector. If you specify a scalar value, that setting is used for all channels. If you specify a value of 1, the corresponding channel is reset to the value specified in the initial value vector. If you specify a value of 0, the channel remains at the last value attained while the model was running.

**Initial value vector** – The initial value vector contains the initial voltage values for the output channels. Enter a scalar or a vector that is the same length as the channel vector. If you specify a scalar value, that value is the initial value for all channels. The channels are set to the initial values between the time the model is downloaded and the time it is started.

**Sample time** — Base sample time of a multiple of the base sample time.

**Base address** - Enter the base address of the board. It is important that this entry corresponds to the DIP switch settings on the board. For example, if the base address is 300 (hexadecimal), enter

0x300

The jumpers by the range DIP switches on the board all have to be in the XFER position. The Wait-State jumper has to be in the off position.

## CIO-DAS16/330

The CIO-DAS16/330 is an I/O board with 16 single or 8 differential analog input (A/D) channels (12-bit) with a maximum sample rate of 330 kHz, 4 digital input lines, and 4 digital output lines.

xPC Target supports this board with one driver block:

- “CIO-DAS16/330 Analog Input (A/D)” on page 21-34

---

**Note** xPC Target does not support the digital I/O on this board.

---

### Board Characteristics

|                                 |                |
|---------------------------------|----------------|
| Board name                      | CIO-DAS16/330  |
| Manufacturer                    | ComputerBoards |
| Bus type                        | ISA            |
| Access method                   | I/O mapped     |
| Multiple block instance support | No             |
| Multiple board support          | Yes            |

## CIO-DAS16/330 Analog Input (A/D)

### Scaling Input to Output

| Hardware Input | Block Output Data Type | Scaling |
|----------------|------------------------|---------|
| volts          | Double                 | 1       |

### Driver Block Parameters

**Number of Channels** — If you select 16 channels (**Input coupling** parameter set to 16 single-ended channels) enter a number between 1 and 16 to select the number of A/D channels used. If you select eight channels (**Input coupling** parameter set to 8 differential channels) enter a number between 1 and 8. This driver does not allow the selection of individual channels or to mix single-ended and differential inputs.

Number the lines beginning with 1 even if the board manufacturer starts numbering the lines with 0.

**Range** — From the list, choose either +-10V (-10 volts to +10 volts), +-5V, +-2.5V, +-1.25V, +-0.625V, 0-10V, 0-5V, 0-2.5V, or 0-1.25V. This driver does not allow the selection of different range for each channel.

**Input coupling** — From the list, select one from the following list of input modes:

- Single-ended (16 channels)
- Differential (8 channels)

This choice must correspond to the MUX-switch setting on the board.

**Sample time** — Enter the base sample time or a multiple of the base sample time.

**Base address** — Enter the base address of the board. It is important that this entry corresponds to the DIP switch settings on the board. For example, if the base address is 300 (hexadecimal), enter

0x300

## CIO-DAS16/JR (/12)

The CIO-DAS16/JR is an I/O board with 16 single or 8 differential analog input (A/D) channels (12-bit) with a maximum sample rate of 130 kHz, 4 digital input lines, 4 digital output lines, and 3 counter/timers (16-bit). An external signal conditioning board can be added to the CIO-DAS16/JR board.

xPC Target supports this board with these driver blocks:

- “CIO-DAS16/JR Analog Input (A/D)” on page 21-36
- “CIO-DAS16/JR (/12) Analog Input (A/D) with EXP Signal Conditioning Board” on page 21-37

---

**Note** xPC Target does not support the digital I/O or counters on this board.

---

### Board Characteristics

|                                 |                |
|---------------------------------|----------------|
| Board name                      | CIO-DAS16/JR   |
| Manufacturer                    | ComputerBoards |
| Bus type                        | ISA            |
| Access method                   | I/O mapped     |
| Multiple block instance support | No             |
| Multiple board support          | Yes            |

## CIO-DAS16/JR Analog Input (A/D)

### Scaling Input to Output

| Hardware Input | Block Output Data Type | Scaling |
|----------------|------------------------|---------|
| volts          | Double                 | 1       |

### Driver Block Parameters

**Number of Channels** — If you select 16 channels (**Input coupling** parameter set to 16 single-ended channels) enter a number between 1 and 16 to select the number of A/D channels used. If you select eight channels (**Input coupling** parameter set to 8 differential channels) enter a number between 1 and 8. This driver does not allow the selection of individual channels or to mix single-ended and differential inputs.

Number the lines beginning with 1 even if the board manufacturer starts numbering the lines with 0.

**Range** — From the list, choose either +-10V (-10 volts to +10 volts), +-5V, +-2.5V, +-1.25V, +-0.625V, 0-10V, 0-5V, 0-2.5V, or 0-1.25V. This driver does not allow the selection of a different range for each channel.

**Input coupling** — From the list, select one from the following list of input modes:

- Single-ended (16 channels)
- Differential (8 channels)

This choice must correspond to the MUX-switch setting on the board.

**Sample time** — Enter the base sample time or a multiple of the base sample time.

**Base address** — Enter the base address of the board. It is important that this entry corresponds to the DIP switch settings on the board. For example, if the base address is 300 (hexadecimal), enter

0x300

## CIO-DAS16/JR (/12) Analog Input (A/D) with EXP Signal Conditioning Board

### Scaling Input to Output

| Hardware Input | Block Output Data Type | Scaling |
|----------------|------------------------|---------|
| volts          | Double                 | 1       |

There are signal conditioning boards (external devices) available from ComputerBoards which can be connected to the CIO-DAS16/JR. Each EXP-board contains its own multiplexer circuit which multiplexes a maximum number of 16 EXP-channels to one A/D-channel of the CIO-DAS16/JR. For this type of operation the CIO-DAS16/JR has to be setup for single-ended input mode and this results in a theoretical number of 256 EXP-channels per CIO-DAS/16JR board.

- EXP16
- EXP32
- EXP-BRIDGE16
- EXP-RTD
- EXP-GP

### Driver Block Parameters

**EXP Channel vector** — This parameter describes the EXP-channels used. Because always a group of 16 EXP-channels are mapped to one A/D-channel of the CIO-DAS16/JR the EXP-channel vector can contain elements between 0 and 15 and no value should occur twice. The number of elements of the vector defines the number of block outputs. The EXP-channel defined as the first element is output at the first block output, the EXP-channel defined as the second element is output at the second block output and so on.

```
Example:EXP Channel Vector:[4,0,12]
the Signal of EXP-channel 4 is output at block output 1
the Signal of EXP-channel 0 is output at block output 2
the Signal of EXP-channel 12 is output at block output 3
```

**Note** If a EXP32 is used and the EXP-channels 16 to 31 should be acquired, the elements of the EXP Channel Vector have still to be in the range of 0 to 15. Therefore the EXP-channel numbers have to be subsaturated by the constant 16.

A special case is provided by setting the EXP Channel Vector to an empty vector. In this case it is assumed that no EXP-board is connected to the specified A/D-channel (see dialog field A/D Board Channel) and the signal is directly connected to the A/D-input of the CIO-DAS16Jr board. This feature allows to use the A/D-channels of a CIO-DAS16Jr either for EXP-channels or for direct input. Therefore it is not necessary to purchase another A/D-board for direct input.

---

**Note** This feature should only be used if at least one EXP-board has to be connected to the CIO-DAS16Jr. If all inputs are directly connected to the A/D board use the CIO-DAS16Jr/12 (2.2.1) driver instead which allows much higher sample rates.

---

**EXP Gain** — This parameter describes the gains for each EXP-channel used. This vector corresponds over his indices with the EXP-gain vector and must therefore have the same length. Because this I/O-driver can be used together with all different EXP-boards there is no restriction about the gain value itself. The EXP-board manual should be contacted to know what the gains of the different EXP-boards are. The gains on the EXP-board depend on several DIP switches on the specific EXP-board.

Example:EXP Channel Vector:[4,0,12]

EXP Gain Vector:[1,1000,200]

EXP-channel 4 has gain 1, channel 0 gain 1000 and channel 12 gain 200

If EXP Channel Vector is an empty vector EXP Gain Vector has to be an empty vector as well.

**A/D Board Channel** — This field specifies to which A/D-channel of the CIO-DAS16Jr the block of 16 EXP-channels are mapped. Because the input coupling of the A/D board has to be single-ended channel 0 to 16 can be used. The channel selection jumpers on the EXP-boards have to be set accordingly to this software setting.



**A/D Board Range** — This field specifies the input voltage range for the CIO-DAS16/JR which is the same for all 16 single-ended channels.

From the list, choose either +-10V (-10 volts to +10 volts), +-5V, +-2.5V, +-1.25V, +-0.625V, 0-10V, 0-5V, 0-2.5V, or 0-1.25V. This driver does not allow the selection of different range for each channel.

**Sample time** — Enter the base sample time or a multiple of the base sample time.

**Base address** - Enter the base address of the board. It is important that this entry corresponds to the DIP switch settings on the board. For example, if the base address is 300 (hexadecimal), enter

0x300

---

**Note** If this driver is used the input coupling switch on the CIO-DAS16Jr has always to be in the 16 (single-ended) position.

---

## CIO-DAS16JR/16

The CIO-DAS16JR/16 is an I/O board with 16 single or 8 differential analog input (A/D) channels (16-bit) with a maximum sample rate of 100 kHz, 4 digital input lines, 4 digital output lines and 3 counter/timers.

xPC Target supports this board with this driver block:

- “CIO-DAS16JR/16 Analog Input (A/D)” in Chapter 21

---

**Note** xPC Target does not support the digital I/O or the counters on this board.

---

### Board Characteristics

|                                 |                |
|---------------------------------|----------------|
| Board name                      | CIO-DAS16JR/16 |
| Manufacturer                    | ComputerBoards |
| Bus type                        | ISA            |
| Access method                   | I/O mapped     |
| Multiple block instance support | No             |
| Multiple board support          | Yes            |

## CIO-DAS16JR/16 Analog Input (A/D)

### Scaling Input to Output

| Hardware Input | Block Output Data Type | Scaling |
|----------------|------------------------|---------|
| volts          | Double                 | 1       |

### Driver Block Parameters

**Number of Channels** — If you select 16 channels (**Input coupling** parameter set to 16 single-ended channels) enter a number between 1 and 16 to select the number of A/D channels used. If you select eight channels (**Input coupling** parameter set to 8 differential channels) enter a number between 1 and 8. This driver does not allow the selection of individual channels or to mix single-ended and differential inputs.

Number the lines beginning with 1 even if the board manufacturer starts numbering the lines with 0.

**Range** — From the list, choose either +10V (-10 volts to +10 volts), +5V, +2.5V, +1.25V, +0.625V, 0-10V, 0-5V, 0-2.5V, or 0-1.25V. This driver does not allow the selection of a different range for each channel.

**Input coupling** — From the list, select one of the input modes:

- Single-ended channels (16 channels)
- Differential channels (8 channels)

This choice must correspond to the MUX-switch setting on the board.

**Sample time** — Enter the base sample time or a multiple of the base sample time.

**Base address** — Enter the base address of the board. It is important that this entry corresponds to the DIP switch settings on the board. For example, if the base address is 300 (hexadecimal), enter

0x300

## CIO-DAS1601/12

The CIO-DAS1601/12 is an I/O board with 16 single or 8 differential analog input (A/D) channels (12-bit) with a maximum sampling rate of 160 kHz, 2 analog output (D/A) channels (12-bit), 32 digital input and output lines, and 3 counters (16-bit).

xPC Target supports this board with these driver blocks:

- “CIO-DAS1601/12 Analog Input (A/D)” on page 21-43
- “CIO-DAS1601/12 Analog Output (D/A)” on page 21-44
- “CIO-DAS1601/12 Digital Input” on page 21-45
- “CIO-DAS1601/12 Digital Output” on page 21-46

---

**Note** xPC Target supports only 24 digital I/O lines and does not support the counters on this board.

---

### Board Characteristics

|                                 |                                     |
|---------------------------------|-------------------------------------|
| Board name                      | CIO-DAS1601/12                      |
| Manufacturer                    | ComputerBoards                      |
| Bus type                        | ISA                                 |
| Access method                   | I/O mapped                          |
| Multiple block instance support | A/D: No, D/A: Yes, Digital I/O: Yes |
| Multiple board support          | Yes                                 |

## CIO-DAS1601/12 Analog Input (A/D)

### Scaling Input to Output

| Hardware Input | Block Output Data Type | Scaling |
|----------------|------------------------|---------|
| volts          | Double                 | 1       |

### Driver Block Parameters

**Number of Channels** — If you select 16 channels (**Input coupling** parameter set to 16 single-ended channels) enter a number between 1 and 16 to select the number of A/D channels used. If you select eight channels (**Input coupling** parameter set to 8 differential channels) enter a number between 1 and 8. This driver does not allow the selection of individual channels or to mix single-ended and differential inputs.

Number the lines beginning with 1 even if the board manufacturer starts numbering the lines with 0.

**Range** — From the list, choose either + -10V (-10 volts to +10 volts), + -5V, + -2.5V, + -1.25V, + -0.625V, 0-10V, 0-5V, 0-2.5V, or 0-1.25V. This driver does not allow the selection of a different range for each channel.

If a bipolar range is used, the bipolar switch on the board must be in the bipolar position. If a unipolar range is used, the bipolar switch must be in the unipolar position.

**Input coupling** — From the list, select one from the following list of input modes:

- Single-ended channels (16 channels)
- Differential channels (8 channels)

This choice must correspond to the MUX-switch setting on the board.

**Sample time** — Enter the base sample time or a multiple of the base sample time.

**Base address** — Enter the base address of the board. It is important that this entry corresponds to the DIP switch settings on the board. For example, if the base address is 300 (hexadecimal), enter

0x300

## CIO-DAS1601/12 Analog Output (D/A)

### Scaling Input to Output

| Hardware Output | Block Input Data Type | Scaling |
|-----------------|-----------------------|---------|
| volts           | Double                | 1       |

### Driver Block Parameters

**Channel vector** — Enter 1 or 2. This driver allows the selection of individual D/A channels in any order. The number of elements defines the number of D/A channels used. For example, to use the first and second analog output (D/A) channels, enter

[1,2]

Number the channels beginning with 1 even if the board manufacturer starts numbering the channels with 0.

**Range vector** — Enter a range code for each of the channels in the channel vector. The range vector must be the same length as the channel vector. This board allows the range of each channel to be different.

The following table is a list of the ranges for this driver and the corresponding range codes.

| Input range (V) | Range code | Input range (V) | Range code |
|-----------------|------------|-----------------|------------|
| -10 to +10      | -10        | 0 - 10          | 10         |
| -5 to +5        | -5         | 0 - 5           | 5          |

For example, if the first channel is -10 to +10 volts, and the second channel is 0 to 5 volts, enter

[-10,5]

The range settings have to correspond to the DIP switch settings on the board. Also the Bipolar/ Unipolar jumpers have to be placed according to the ranges used.

**Reset vector** — The reset vector controls the behavior of the channel at model termination. Enter a scalar or a vector that is the same length as the channel vector. If you specify a scalar value, that setting is used for all channels. If you specify a value of 1, the corresponding channel is reset to the value specified in the initial value vector. If you specify a value of 0, the channel remains at the last value attained while the model was running.

**Initial value vector** — The initial value vector contains the initial voltage values for the output channels. Enter a scalar or a vector that is the same length as the channel vector. If you specify a scalar value, that value is the initial value for all channels. The channels are set to the initial values between the time the model is downloaded and the time it is started.

**Sample time** — Base sample time of a multiple of the base sample time.

**Base address** — Enter the base address of the board. It is important that this entry corresponds to the DIP switch settings on the board. For example, if the base address is 300 (hexadecimal), enter

0x300

## **CIO-DAS1601/12 Digital Input**

The DAS1601/12 has a 8255 chip with 3 ports (A,B,C). Each port has a maximum of 8 digital I/O lines that can be configured as inputs or outputs.

Use a separate driver block for each port. By selecting the digital input driver block, the port is configured as input.

## Scaling Input to Output

| Hardware Input | Block Output Data Type | Scaling                         |
|----------------|------------------------|---------------------------------|
| TTL            | Double                 | TTL low = 0.0<br>TTL high = 1.0 |

### Driver Block Parameters

**Channel vector** — Enter numbers between 1 and 8 to select the digital input lines used with this port. This driver allows the selection of individual digital input lines in any order. The number of elements defines the number of digital lines used.

For example, to use all of the digital inputs for one port, enter

[ 1,2,3,4,5,6,7,8]

Number the lines beginning with 1 even if the board manufacturer starts numbering the lines with 0.

**Port** — From the list choose either A, B, or C. The I/O board has a 8255 chip with 3 ports. The port name defines which port of the 8255 chip is used for this driver block. Each port has a maximum of 8 digital lines that can be configured as inputs or outputs depending on which driver block is chosen. In each case, one block is needed for each port.

**Sample time** — Enter a base sample time or a multiple of the base sample time.

**Base address** — Enter the base address of the board. This entry must corresponds to the DIP switch settings on the board. For example, if the base address is 300 (hexadecimal), enter

0x300

### CIO-DAS1601/12 Digital Output

The DAS1601/12 has a 8255 chip with 3 ports (A,B,C). Each port has a maximum of 8 digital I/O lines that can be configured as inputs or outputs.

Use a separate driver block for each port. By selecting the digital output driver block, the port is configured as output.



## Scaling Input to Output

| Hardware Output | Block Input Data Type | Scaling                             |
|-----------------|-----------------------|-------------------------------------|
| TTL             | Double                | < 0.5 = TTL low<br>≥ 0.5 = TTL high |

## Driver Block Parameters

**Channel vector** — Enter numbers between 1 and 8 to select the digital output lines used with this port. This driver allows the selection of individual digital output lines in any order. The number of elements defines the number of digital lines used.

For example, to use all of the digital outputs for one port, enter

```
[1,2,3,4,5,6,7,8]
```

Number the lines beginning with 1 even if the board manufacturer starts numbering the lines with 0.

**Port** — From the list choose either A, B, or C. The I/O board has a 8255 chip with 3 ports. The port name defines which port of the 8255 chip is used for this driver block. Each port has a maximum of 8 digital lines that can be configured as inputs or outputs depending on which driver block is chosen. In each case, one block is needed for each port.

**Reset vector** — The reset vector controls the behavior of the channel at model termination. Enter a scalar or a vector that is the same length as the channel vector. If you specify a scalar value, that setting is used for all channels. If you specify a value of 1, the corresponding channel is reset to the value specified in the initial value vector. If you specify a value of 0, the channel remains at the last value attained while the model was running.

**Initial value vector** — The initial value vector contains the initial values (0 or 1) of the output channels. Enter a scalar or a vector that is the same length as the channel vector. If you enter a scalar, that value is used for all channels. The channels are set to these initial values between the time the model is downloaded and the time it is started.

**Sample time** — Enter a base sample time or a multiple of the base sample time.

**Base address** — Enter the base address of the board. This entry must correspond to the DIP switch settings on the board. For example, if the base address is 300 (hexadecimal), enter

0x300

## CIO-DAS1602/12

The CIO-DAS1602/12 is an I/O board with 16 single or 8 differential analog input (A/D) channels (12-bit) with a maximum sampling rate of 100kHz, 2 analog output (D/A) channels (12-bit), 32 digital input and output lines, and 3 counters (16-bit).

xPC Target supports this board with these driver blocks:

- “CIO-DAS1602/12 Analog Input (A/D)” on page 21-50
- “CIO-DAS1602/12 Analog Output (D/A)” on page 21-51
- “CIO-DAS1602/12 Digital Input” on page 21-52
- “CIO-DAS1602/12 Digital Output” on page 21-53

---

**Note** xPC Target supports only 24 digital I/O lines and does not support the counters on this board.

---

### Board Characteristics

|                                 |                                     |
|---------------------------------|-------------------------------------|
| Board Name                      | CIO-DAS1602/12                      |
| Manufacturer                    | ComputerBoards                      |
| Bus type                        | ISA                                 |
| Access method                   | I/O mapped                          |
| Multiple block instance support | A/D: No, D/A: Yes, Digital I/O: Yes |
| Multiple board support          | Yes                                 |

## CIO-DAS1602/12 Analog Input (A/D)

### Scaling Input to Output

| Hardware Input | Block Output Data Type | Scaling |
|----------------|------------------------|---------|
| volts          | Double                 | 1       |

### Driver Block Parameters

**Number of Channels** — If you select 16 channels (**Input coupling** parameter set to 16 single-ended channels) enter a number between 1 and 16 to select the number of A/D channels used. If you select eight channels (**Input coupling** parameter set to 8 differential channels) enter a number between 1 and 8. This driver does not allow the selection of individual channels or to mix single-ended and differential inputs.

**Range** — From the list, choose either +-10V (-10 volts to +10 volts), +-5V, +-2.5V, +-1.25V, +-0.625V, 0-10V, 0-5V, 0-2.5V, or 0-1.25V. This driver does not allow the selection of a different range for each channel.

If a bipolar range is used, the bipolar switch on the board must be in the bipolar position. If a unipolar range is used, the bipolar switch must be in the unipolar position.

**Input coupling** — From the list, select one from the following list of input modes:

- Single-ended channels (16 channels)
- Differential channels (8 channels)

This choice must correspond to the MUX-switch setting on the board.

**Sample time** — Enter the base sample time or a multiple of the base sample time.

**Base address** — Enter the base address of the board. It is important that this entry corresponds to the DIP switch settings on the board. For example, if the base address is 300 (hexadecimal), enter

0x300

## CIO-DAS1602/12 Analog Output (D/A)

### Scaling Input to Output

| Hardware Output | Block Input Data Type | Scaling |
|-----------------|-----------------------|---------|
| volts           | Double                | 1       |

### Driver Block Parameters

**Channel vector** — Enter 1 or 2. This driver allows the selection of individual D/A channels in any order. The number of elements defines the number of D/A channels used. For example, to use the first and second analog output (D/A) channels, enter

[ 1,2]

Number the channels beginning with 1 even if the board manufacturer starts numbering the channels with 0.

**Range vector** — Enter a range code for each of the channels in the channel vector. The range vector must be the same length as the channel vector. This board allows the range of each channel to be different.

The following table is a list of the ranges for this driver and the corresponding range codes.

| Input range (V) | Range code | Input range (V) | Range code |
|-----------------|------------|-----------------|------------|
| -10 to +10      | -10        | 0 - 10          | 10         |
| -5 to +5        | -5         | 0 - 5           | 5          |

For example, if the first channel is -10 to +10 volts, and the second channel is 0 to 5 volts, enter

[ -10,5]

The range settings have to correspond to the DIP switch settings on the board. Also the Bipolar/ Unipolar jumpers have to be planted according to the ranges used.

**Reset vector** — The reset vector controls the behavior of the channel at model termination. Enter a scalar or a vector that is the same length as the channel vector. If you specify a scalar value, that setting is used for all channels. If you specify a value of 1, the corresponding channel is reset to the value specified in the initial value vector. If you specify a value of 0, the channel remains at the last value attained while the model was running.

**Initial value vector** — The initial value vector contains the initial voltage values for the output channels. Enter a scalar or a vector that is the same length as the channel vector. If you specify a scalar value, that value is the initial value for all channels. The channels are set to the initial values between the time the model is downloaded and the time it is started.

**Sample time** — Base sample time or a multiple of the base sample time.

**Base address** — Enter the base address of the board. It is important that this entry corresponds to the DIP switch settings on the board. For example, if the base address is 300 (hexadecimal), enter

0x300

## CIO-DAS1602/12 Digital Input

The DAS1601/12 has a 8255 chip with 3 ports (A,B,C). Each port has a maximum of 8 digital I/O lines that can be configured as inputs or outputs.

Use a separate driver block for each port. By selecting the digital input driver block, the port is configured as input.

### Scaling Input to Output

| Hardware Input | Block Output Data Type | Scaling                         |
|----------------|------------------------|---------------------------------|
| TTL            | Double                 | TTL low = 0.0<br>TTL high = 1.0 |

### Driver Block Parameters

**Channel vector** — Enter numbers between 1 and 8 to select the digital input lines used with this port. This driver allows the selection of individual digital input lines in any order. The number of elements defines the number of digital lines used.

For example, to use all of the digital inputs for one port, enter

```
[1,2,3,4,5,6,7,8]
```

Number the lines beginning with 1 even if the board manufacturer starts numbering the lines with 0.

**Port** — From the list choose either A, B, or C. The I/O board has a 8255 chip with 3 ports. The port name defines which port of the 8255 chip is used for this driver block. Each port has a maximum of 8 digital lines that can be configured as inputs or outputs depending on which driver block is chosen. In each case, one block is needed for each port.

**Sample time** — Enter a base sample time or a multiple of the base sample time.

**Base address** — Enter the base address of the board. This entry must correspond to the DIP switch settings on the board. For example, if the base address is 300 (hexadecimal), enter

```
0x300
```

## CIO-DAS1602/12 Digital Output

The DAS1601/12 has a 8255 chip with 3 ports (A,B,C). Each port has a maximum of 8 digital I/O lines that can be configured as inputs or outputs.

Use a separate driver block for each port. By selecting the digital output driver block, the port is configured as output.

### Scaling Input to Output

| Hardware Output | Block Input Data Type | Scaling                             |
|-----------------|-----------------------|-------------------------------------|
| TTL             | Double                | < 0.5 = TTL low<br>≥ 0.5 = TTL high |

### Driver Block Parameters

**Channel vector** — Enter numbers between 1 and 8 to select the digital output lines used with this port. This driver allows the selection of individual digital output lines in any order. The number of elements defines the number of digital lines used.

For example, to use all of the digital outputs for one port, enter

```
[1,2,3,4,5,6,7,8]
```

Number the lines beginning with 1 even if the board manufacturer starts numbering the lines with 0.

**Port** — From the list choose either A, B, or C. The I/O board has a 8255 chip with 3 ports. The port name defines which port of the 8255 chip is used for this driver block. Each port has a maximum of 8 digital lines that can be configured as inputs or outputs depending on which driver block is chosen. In each case, one block is needed for each port.

**Reset vector** — The reset vector controls the behavior of the channel at model termination. Enter a scalar or a vector that is the same length as the channel vector. If you specify a scalar value, that setting is used for all channels. If you specify a value of 1, the corresponding channel is reset to the value specified in the initial value vector. If you specify a value of 0, the channel remains at the last value attained while the model was running.

**Initial value vector** — The initial value vector contains the initial values (0 or 1) of the output channels. Enter a scalar or a vector that is the same length as the channel vector. If you enter a scalar, that value is used for all channels. The channels are set to these initial values between the time the model is downloaded and the time it is started.

**Sample time** — Enter a base sample time or a multiple of the base sample time.

**Base address** — Enter the base address of the board. This entry must correspond to the DIP switch settings on the board. For example, if the base address is 300 (hexadecimal), enter

```
0x300
```



## CIO-DAS1602/16

The CIO-DAS1602/16 is an I/O board with 16 single or 8 differential analog input (A/D) channels (16-bit) with a maximum sampling rate of 100kHz, 2 analog output (D/A) channels (16-bit), 32 digital I/O lines, and 3 counters (16-bit).

xPC Target supports this board with these driver blocks:

- “CIO-DAS1602/16 Analog Input (A/D)” on page 21-56
- “CIO-DAS1602/16 Analog Output (D/A)” on page 21-57
- “CIO-DAS 1602/16 Digital Input” on page 21-58
- “CIO DAS1602/16 Digital Output” on page 21-59

---

**Note** xPC Target supports only 24 digital I/O lines and does not support the counters on this board.

---

### Board Characteristics

|                                 |                                     |
|---------------------------------|-------------------------------------|
| Board Name                      | CIO-DAS1602/16                      |
| Manufacturer                    | ComputerBoards                      |
| Bus type                        | ISA                                 |
| Access method                   | I/O mapped                          |
| Multiple block instance support | A/D: No, D/A: Yes, Digital I/O: Yes |
| Multiple board support          | Yes                                 |

## CIO-DAS1602/16 Analog Input (A/D)

### Scaling Input to Output

| Hardware Input | Block Output Data Type | Scaling |
|----------------|------------------------|---------|
| volts          | Double                 | 1       |

#### Driver Block Parameters

**Number of Channels** — If you select 16 channels (**Input coupling** parameter set to 16 single-ended channels) enter a number between 1 and 16 to select the number of A/D channels used. If you select eight channels (**Input coupling** parameter set to 8 differential channels) enter a number between 1 and 8. This driver does not allow the selection of individual channels or to mix single-ended and differential inputs.

**Range** — From the list, choose either +-10V (-10 volts to +10 volts), +-5V, +-2.5V, +-1.25V, +-0.625V, 0-10V, 0-5V, 0-2.5V, or 0-1.25V. This driver does not allow the selection of a different range for each channel.

If a bipolar range is used, the bipolar switch on the board must be in the bipolar position. If a unipolar range is used, the bipolar switch must be in the unipolar position.

**Input coupling** — From the list, select one from the following list of input modes:

- Single-ended channels (16 channels)
- Differential channels (8 channels)

This choice must correspond to the MUX-switch setting on the board.

**Sample time** — Enter the base sample time or a multiple of the base sample time.

**Base address** — Enter the base address of the board. It is important that this entry corresponds to the DIP switch settings on the board. For example, if the base address is 300 (hexadecimal), enter

0x300

## CIO-DAS1602/16 Analog Output (D/A)

### Scaling Input to Output

| Hardware Output | Block Input Data Type | Scaling |
|-----------------|-----------------------|---------|
| volts           | Double                | 1       |

### Driver Block Parameters

**Channel vector** — Enter 1 or 2. This driver allows the selection of individual D/A channels in any order. The number of elements defines the number of D/A channels used. For example, to use the first and second analog output (D/A) channels, enter

[ 1,2]

Number the channels beginning with 1 even if the board manufacturer starts numbering the channels with 0.

**Range vector** — Enter a range code for each of the channels in the channel vector. The range vector must be the same length as the channel vector. This board allows the range of each channel to be different.

The following table is a list of the ranges for this driver and the corresponding range codes.

| Input Range (V) | Range Code | Input Range (V) | Range Code |
|-----------------|------------|-----------------|------------|
| -10 to +10      | -10        | 0 - 10          | 10         |
| -5 to +5        | -5         | 0 - 5           | 5          |

For example, if the first channel is -10 to +10 volts, and the second channel is 0 to 5 volts, enter

[ -10,5]

The range settings have to correspond to the DIP switch settings on the board. Also the Bipolar/ Unipolar jumpers have to be planted according to the ranges used.

**Reset vector** — The reset vector controls the behavior of the channel at model termination. Enter a scalar or a vector that is the same length as the channel vector. If you specify a scalar value, that setting is used for all channels. If you specify a value of 1, the corresponding channel is reset to the value specified in the initial value vector. If you specify a value of 0, the channel remains at the last value attained while the model was running.

**Initial value vector** — The initial value vector contains the initial voltage values for the output channels. Enter a scalar or a vector that is the same length as the channel vector. If you specify a scalar value, that value is the initial value for all channels. The channels are set to the initial values between the time the model is downloaded and the time it is started.

**Sample time** — Base sample time of a multiple of the base sample time.

**Base address** — Enter the base address of the board. It is important that this entry corresponds to the DIP switch settings on the board. For example, if the base address is 300 (hexadecimal), enter

0x300

## CIO-DAS 1602/16 Digital Input

The DAS1601/16 has a 8255 chip with 3 ports (A,B,C). Each port has a maximum of 8 digital I/O lines that can be configured as inputs or outputs.

Use a separate driver block for each port. By selecting the digital input driver block, the port is configured as input.

### Scaling Input to Output

| Hardware Input | Block Output Data Type | Scaling                         |
|----------------|------------------------|---------------------------------|
| TTL            | Double                 | TTL low = 0.0<br>TTL high = 1.0 |

### Driver Block Parameters

**Channel vector** — Enter numbers between 1 and 8 to select the digital input lines used with this port. This driver allows the selection of individual digital input lines in any order. The number of elements defines the number of digital lines used.

For example, to use all of the digital inputs for one port, enter

```
[1,2,3,4,5,6,7,8]
```

Number the lines beginning with 1 even if the board manufacturer starts numbering the lines with 0.

**Port** — From the list choose either A, B, or C. The I/O board has a 8255 chip with 3 ports. The port name defines which port of the 8255 chip is used for this driver block. Each port has a maximum of 8 digital lines that can be configured as inputs or outputs depending on which driver block is chosen. In each case, one block is needed for each port.

**Sample time** — Enter a base sample time or a multiple of the base sample time.

**Base address** — Enter the base address of the board. This entry must correspond to the DIP switch settings on the board. For example, if the base address is 300 (hexadecimal), enter

```
0x300
```

## CIO DAS1602/16 Digital Output

The DAS1601/16 has a 8255 chip with 3 ports (A,B,C). Each port has a maximum of 8 digital I/O lines that can be configured as inputs or outputs.

Use a separate driver block for each port. By selecting the digital output driver block, the port is configured as output.

### Scaling Input to Output

| Hardware Output | Block Input Data Type | Scaling                             |
|-----------------|-----------------------|-------------------------------------|
| TTL             | Double                | < 0.5 = TTL low<br>≥ 0.5 = TTL high |

### Driver Block Parameters

**Channel vector** — Enter numbers between 1 and 8 to select the digital output lines used with this port. This driver allows the selection of individual digital output lines in any order. The number of elements defines the number of digital lines used.

For example, to use all of the digital outputs for one port, enter

```
[1,2,3,4,5,6,7,8]
```

Number the lines beginning with 1 even if the board manufacturer starts numbering the lines with 0.

**Port** — From the list choose either **A**, **B**, or **C**. The I/O board has a 8255 chip with 3 ports. The port name defines which port of the 8255 chip is used for this driver block. Each port has a maximum of 8 digital lines that can be configured as inputs or outputs depending on which driver block is chosen. In each case, one block is needed for each port.

**Reset vector** — The reset vector controls the behavior of the channel at model termination. Enter a scalar or a vector that is the same length as the channel vector. If you specify a scalar value, that setting is used for all channels. If you specify a value of 1, the corresponding channel is reset to the value specified in the initial value vector. If you specify a value of 0, the channel remains at the last value attained while the model was running.

**Initial value vector** — The initial value vector contains the initial values (0 or 1) of the output channels. Enter a scalar or a vector that is the same length as the channel vector. If you enter a scalar, that value is used for all channels. The channels are set to these initial values between the time the model is downloaded and the time it is started.

**Sample time** — Enter a base sample time or a multiple of the base sample time.

**Base address** — Enter the base address of the board. This entry must correspond to the DIP switch settings on the board. For example, if the base address is 300 (hexadecimal), enter

```
0x300
```

## CIO-DDA06 (/12)

The CIO-DDA06 (/12) is an I/O board with 6 analog output (D/A) channels (12-bit), and 24 digital I/O lines.

xPC Target supports this board with these driver blocks:

- “CIO-DDA06 (/12) Analog Output (D/A)” on page 21-62
- “CIO-DDA06 (/12) Digital Input” on page 21-63
- “CIO-DDA06 (/12) Digital Output” on page 21-64

### Board Characteristics

|                                 |                 |
|---------------------------------|-----------------|
| Board name                      | CIO-DDA06 (/12) |
| Manufacturer                    | ComputerBoards  |
| Bus type                        | ISA             |
| Access method                   | I/O mapped      |
| Multiple block instance support | Yes             |
| Multiple board support          | Yes             |

## CIO-DDA06 (/12) Analog Output (D/A)

### Scaling Input to Output

| Hardware Output | Block Input Data Type | Scaling |
|-----------------|-----------------------|---------|
| volts           | Double                | 1       |

### Driver Block Parameters

**Channel vector** — Enter numbers between 1 and 6. This driver allows the selection of individual D/A channels in any order. The number of elements defines the number of D/A channels used. For example, to use the first and second analog output (D/A) channels, enter

[ 1, 2 ]

Number the channels beginning with 1 even if the board manufacturer starts numbering the channels with 0.

**Range vector** — Enter a range code for each of the channels in the channel vector. The range vector must be the same length as the channel vector. This board allows the range of each channel to be different.

The following table is a list of the ranges for this driver and the corresponding range codes.

| Input Range (V) | Range Code | Input Range (V) | Range Code |
|-----------------|------------|-----------------|------------|
| -10 to +10      | -10        | 0 to 10         | 10         |
| -5 to +5        | -5         | 0 to +5         | 5          |
| -2.5 to +2.5    | -2.5       | 0 to +2.5       | 2.5        |
| -1.67 to +1.67  | -1.67      | 0 to +1.67      | 1.67       |
| -.625 to +.625  | -0.625     |                 |            |

For example, if the first channel is -10 to +10 volts, and the second channel is 0 to 5 volts, enter

[ - 10, 5 ]



The range settings have to correspond to the DIP switch settings on the board. The jumpers by the range DIP switches on the board all have to be in the XFER position. The Wait-State jumper has to be in the off position.

**Reset vector** — The reset vector controls the behavior of the channel at model termination. Enter a scalar or a vector that is the same length as the channel vector. If you specify a scalar value, that setting is used for all channels. If you specify a value of 1, the corresponding channel is reset to the value specified in the initial value vector. If you specify a value of 0, the channel remains at the last value attained while the model was running.

**Initial value vector** — The initial value vector contains the initial voltage values for the output channels. Enter a scalar or a vector that is the same length as the channel vector. If you specify a scalar value, that value is the initial value for all channels. The channels are set to the initial values between the time the model is downloaded and the time it is started.

**Sample time** — Base sample time of a multiple of the base sample time.

**Base address** — Enter the base address of the board. It is important that this entry corresponds to the DIP switch settings on the board. For example, if the base address is 300 (hexadecimal), enter

0x300

## CIO-DDA06 (/12) Digital Input

The CIO-DDA06 has a 8255 chip with 3 ports (A,B,C). Each port has a maximum of 8 digital I/O lines that can be configured as inputs or outputs.

Use a separate driver block for each port. By selecting the digital input driver block, the port is configured as input.

## Scaling Input to Output

| Hardware Input | Block Output Data Type | Scaling                         |
|----------------|------------------------|---------------------------------|
| TTL            | Double                 | TTL low = 0.0<br>TTL high = 1.0 |

### Driver Block Parameters

**Channel vector** — Enter numbers between 1 and 8 to select the digital input lines used with this port. This driver allows the selection of individual digital input lines in any order. The number of elements defines the number of digital lines used.

For example, to use all of the digital inputs for one port, enter

```
[1,2,3,4,5,6,7,8]
```

Number the lines beginning with 1 even if the board manufacturer starts numbering the lines with 0.

**Port** — From the list choose either A, B, or C. The I/O board has a 8255 chip with 3 ports. The port name defines which port of the 8255 chip is used for this driver block. Each port has a maximum of 8 digital lines that can be configured as inputs or outputs depending on which driver block is chosen. In each case, one block is needed for each port.

**Sample time** — Enter a base sample time or a multiple of the base sample time.

**Base address** — Enter the base address of the board. This entry must correspond to the DIP switch settings on the board. For example, if the base address is 300 (hexadecimal), enter

```
0x300
```

### CIO-DDA06 (/12) Digital Output

The CIO-DDA06 has a 8255 chip with 3 ports (A,B,C). Each port has a maximum of 8 digital I/O lines that can be configured as inputs or outputs.

Use a separate driver block for each port. By selecting the digital output driver block, the port is configured as output.

## Scaling Input to Output

| Hardware Output | Block Input Data Type | Scaling                             |
|-----------------|-----------------------|-------------------------------------|
| TTL             | Double                | < 0.5 = TTL low<br>≥ 0.5 = TTL high |

## Driver Block Parameters

**Channel vector** — Enter numbers between 1 and 8 to select the digital output lines used with this port. This driver allows the selection of individual digital output lines in any order. The number of elements defines the number of digital lines used.

For example, to use all of the digital outputs for one port, enter

```
[1,2,3,4,5,6,7,8]
```

Number the lines beginning with 1 even if the board manufacturer starts numbering the lines with 0.

**Port** — From the list choose either A, B, or C. The I/O board has a 8255 chip with 3 ports. The port name defines which port of the 8255 chip is used for this driver block. Each port has a maximum of 8 digital lines that can be configured as inputs or outputs depending on which driver block is chosen. In each case, one block is needed for each port.

**Reset vector** — The reset vector controls the behavior of the channel at model termination. Enter a scalar or a vector that is the same length as the channel vector. If you specify a scalar value, that setting is used for all channels. If you specify a value of 1, the corresponding channel is reset to the value specified in the initial value vector. If you specify a value of 0, the channel remains at the last value attained while the model was running.

**Initial value vector** — The initial value vector contains the initial values (0 or 1) of the output channels. Enter a scalar or a vector that is the same length as the channel vector. If you enter a scalar, that value is used for all channels. The channels are set to these initial values between the time the model is downloaded and the time it is started.

**Sample time** — Enter a base sample time or a multiple of the base sample time.

**Base address** - Enter the base address of the board. This entry must correspond to the DIP switch settings on the board. For example, if the base address is 300 (hexadecimal), enter

0x300

## CIO-DDA06/16

The CIO-DDA06/16 is an I/O board with 6 analog output (D/A) channels (16-bit), and 24 digital I/O lines.

xPC Target supports this board with these driver blocks:

- “CIO-DDA06/16 Analog Output (D/A)” on page 21-68
- “CIO-DDA06/16 Digital Input” on page 21-69
- “CIO-DDA06/16 Digital Output” on page 21-70

### Board Characteristics

|                                 |                |
|---------------------------------|----------------|
| Board name                      | CIO-DDA06/16   |
| Manufacturer                    | ComputerBoards |
| Bus type                        | ISA            |
| Access method                   | I/O mapped     |
| Multiple block instance support | Yes            |
| Multiple board support          | Yes            |

## CIO-DDA06/16 Analog Output (D/A)

### Scaling Input to Output

| Hardware Output | Block Input Data Type | Scaling |
|-----------------|-----------------------|---------|
| volts           | Double                | 1       |

### Driver Block Parameters

**Channel vector** — Enter numbers between 1 and 6. This driver allows the selection of individual D/A channels in any order. The number of elements defines the number of D/A channels used. For example, to use the first and second analog output (D/A) channels, enter

[ 1, 2 ]

Number the channels beginning with 1 even if the board manufacturer starts numbering the channels with 0.

**Range vector** — Enter a range code for each of the channels in the channel vector. The range vector must be the same length as the channel vector. This board allows the range of each channel to be different.

The following table is a list of the ranges for this driver and the corresponding range codes.

| Input Range (V) | Range Code | Input Range (V) | Range Code |
|-----------------|------------|-----------------|------------|
| -10 to +10      | -10        | 0 to 10         | 10         |
| -5 to +5        | -5         | 0 to +5         | 5          |
| -2.5 to +2.5    | -2.5       | 0 to +2.5       | 2.5        |
| -1.67 to +1.67  | -1.67      | 0 to +1.67      | 1.67       |
| -.625 to +.625  | -0.625     |                 |            |

For example, if the first channel is -10 to +10 volts, and the second channel is 0 to 5 volts, enter

[ - 10, 5 ]

The range settings have to correspond to the DIP switch settings on the board. The jumpers by the range DIP switches on the board all have to be in the XFER position. The Wait-State jumper has to be in the off position.

**Reset vector** — The reset vector controls the behavior of the channel at model termination. Enter a scalar or a vector that is the same length as the channel vector. If you specify a scalar value, that setting is used for all channels. If you specify a value of 1, the corresponding channel is reset to the value specified in the initial value vector. If you specify a value of 0, the channel remains at the last value attained while the model was running.

**Initial value vector** — The initial value vector contains the initial voltage values for the output channels. Enter a scalar or a vector that is the same length as the channel vector. If you specify a scalar value, that value is the initial value for all channels. The channels are set to the initial values between the time the model is downloaded and the time it is started.

**Sample time** — Base sample time of a multiple of the base sample time.

**Base address** — Enter the base address of the board. It is important that this entry corresponds to the DIP switch settings on the board. For example, if the base address is 300 (hexadecimal), enter

0x300

## CIO-DDA06/16 Digital Input

The CIO-DDA06/16 has a 8255 chip with 3 ports (A,B,C). Each port has a maximum of 8 digital I/O lines that can be configured as inputs or outputs.

Use a separate driver block for each port. By selecting the digital input driver block, the port is configured as input.

## Scaling Input to Output

| Hardware Input | Block Output Data Type | Scaling                         |
|----------------|------------------------|---------------------------------|
| TTL            | Double                 | TTL low = 0.0<br>TTL high = 1.0 |

### Driver Block Parameters

**Channel vector** — Enter numbers between 1 and 8 to select the digital input lines used with this port. This driver allows the selection of individual digital input lines in any order. The number of elements defines the number of digital lines used.

For example, to use all of the digital inputs for one port, enter

```
[1,2,3,4,5,6,7,8]
```

Number the lines beginning with 1 even if the board manufacturer starts numbering the lines with 0.

**Port** — From the list choose either A, B, or C. The I/O board has a 8255 chip with 3 ports. The port name defines which port of the 8255 chip is used for this driver block. Each port has a maximum of 8 digital lines that can be configured as inputs or outputs depending on which driver block is chosen. In each case, one block is needed for each port.

**Sample time** — Enter a base sample time or a multiple of the base sample time.

**Base address** — Enter the base address of the board. This entry must correspond to the DIP switch settings on the board. For example, if the base address is 300 (hexadecimal), enter

```
0x300
```

## CIO-DDA06/16 Digital Output

The CIO-DDA06/16 has a 8255 chip with 3 ports (A,B,C). Each port has a maximum of 8 digital I/O lines that can be configured as inputs or outputs.

Use a separate driver block for each port. By selecting the digital output driver block, the port is configured as output.



## Scaling Input to Output

| Hardware Output | Block Input Data Type | Scaling                             |
|-----------------|-----------------------|-------------------------------------|
| TTL             | Double                | < 0.5 = TTL low<br>≥ 0.5 = TTL high |

### Driver Block Parameters

**Channel vector** — Enter numbers between 1 and 8 to select the digital output lines used with this port. This driver allows the selection of individual digital output lines in any order. The number of elements defines the number of digital lines used.

For example, to use all of the digital outputs for one port, enter

```
[1,2,3,4,5,6,7,8]
```

Number the lines beginning with 1 even if the board manufacturer starts numbering the lines with 0.

**Port** — From the list choose either A, B, or C. The I/O board has a 8255 chip with 3 ports. The port name defines which port of the 8255 chip is used for this driver block. Each port has a maximum of 8 digital lines that can be configured as inputs or outputs depending on which driver block is chosen. In each case, one block is needed for each port.

**Reset vector** — The reset vector controls the behavior of the channel at model termination. Enter a scalar or a vector that is the same length as the channel vector. If you specify a scalar value, that setting is used for all channels. If you specify a value of 1, the corresponding channel is reset to the value specified in the initial value vector. If you specify a value of 0, the channel remains at the last value attained while the model was running.

**Initial value vector** — The initial value vector contains the initial values (0 or 1) of the output channels. Enter a scalar or a vector that is the same length as the channel vector. If you enter a scalar, that value is used for all channels. The channels are set to these initial values between the time the model is downloaded and the time it is started.

**Sample time** — Enter a base sample time or a multiple of the base sample time.

**Base address** — Enter the base address of the board. This entry must correspond to the DIP switch settings on the board. For example, if the base address is 300 (hexadecimal), enter

0x300

## CIO-DIO24

The CIO-DIO24 is an I/O board with 24 digital I/O lines.

xPC Target supports this board with these driver blocks:

- “CIO-DIO24 Digital Input” on page 21-73
- “CIO-DIO24 Digital Output” on page 21-74
- “CIO-DIO24 Signal Conditioning” on page 21-76

### Board Characteristics

|                                 |                |
|---------------------------------|----------------|
| Board name                      | CIO-DIO24      |
| Manufacturer                    | ComputerBoards |
| Bus type                        | ISA            |
| Access method                   | I/O mapped     |
| Multiple block instance support | Yes            |
| Multiple board support          | Yes            |

### CIO-DIO24 Digital Input

The CIO-DIO24 has one 8255 chip with 3 ports (A,B,C). Each port has a maximum of 8 digital I/O lines that can be configured as inputs or outputs.

Use a separate driver block for each port. By selecting the digital input driver block, the port is configured as input.

### Scaling Input to Output

| Hardware Input | Block Output Data Type | Scaling                         |
|----------------|------------------------|---------------------------------|
| TTL            | Double                 | TTL low = 0.0<br>TTL high = 1.0 |

### Driver Block Parameters

**Channel vector** — Enter numbers between 1 and 8 to select the digital input lines used with this port. This driver allows the selection of individual digital input lines in any order. The number of elements defines the number of digital lines used.

For example, to use all of the digital inputs for one port, enter

```
[ 1, 2, 3, 4, 5, 6, 7, 8 ]
```

Number the lines beginning with 1 even if the board manufacturer starts numbering the lines with 0.

**Port** — From the list choose either A, B, or C. The I/O board has a 8255 chip with 3 ports. The **Port** parameter defines which port of the 8255 chip is used for this driver block. Each port has a maximum of 8 digital lines that can be configured as inputs or outputs depending on which driver block is chosen. In each case, one block is needed for each port.

**Sample time** — Enter a base sample time or a multiple of the base sample time.

**Base address** — Enter the base address of the board. This entry must correspond to the DIP switch settings on the board. For example, if the base address is 300 (hexadecimal), enter

```
0x300
```

### CIO-DIO24 Digital Output

The CIO-DIO24 has one 8255 chip with 3 ports (A,B,C). Each port has a maximum of 8 digital I/O lines that can be configured as inputs or outputs.

Use a separate driver block for each port. By selecting the digital output driver block, the port is configured as output.

### Scaling Input to Output

| Hardware Output | Block Input Data Type | Scaling                             |
|-----------------|-----------------------|-------------------------------------|
| TTL             | Double                | < 0.5 = TTL low<br>≥ 0.5 = TTL high |

## Driver Block Parameters

**Channel vector** — Enter numbers between 1 and 8 to select the digital output lines used with this port. This driver allows the selection of individual digital output lines in any order. The number of elements defines the number of digital lines used.

For example, to use all of the digital outputs for one port, enter

```
[ 1, 2, 3, 4, 5, 6, 7, 8 ]
```

Number the lines beginning with 1 even if the board manufacturer starts numbering the lines with 0.

**Port** — From the list choose either A, B, or C. The I/O board has a 8255 chip with 3 ports. The **Port** parameter defines which port of the 8255 chip is used for this driver block. Each port has a maximum of 8 digital lines that can be configured as inputs or outputs depending on which driver block is chosen. In each case, one block is needed for each port.

**Reset vector** — The reset vector controls the behavior of the channel at model termination. Enter a scalar or a vector that is the same length as the channel vector. If you specify a scalar value, that setting is used for all channels. If you specify a value of 1, the corresponding channel is reset to the value specified in the initial value vector. If you specify a value of 0, the channel remains at the last value attained while the model was running.

**Initial value vector** — The initial value vector contains the initial values (0 or 1) of the output channels. Enter a scalar or a vector that is the same length as the channel vector. If you enter a scalar, that value is used for all channels. The channels are set to these initial values between the time the model is downloaded and the time it is started.

**Sample time** — Enter a base sample time or a multiple of the base sample time.

**Base address** — Enter the base address of the board. This entry must correspond to the DIP switch settings on the board. For example, if the base address is 300 (hexadecimal), enter

```
0x300
```

## **CIO-DIO24 Signal Conditioning**

### **Block Parameters**

**Genix initialization file (path\file)** — Provide the filename of the Genix initialization file.

**Base address** — Enter the base address of the board. This entry must correspond to the DIP switch settings on the board. For example, if the base address is 300 (hexadecimal), enter

0x300

## CIO-DIO24H

The CIO-DIO24H is an I/O board with 24 digital I/O lines.

xPC Target supports this board with these driver blocks:

- “CIO-DIO24H Digital Input” on page 21-77
- “CIO-DIO24H Digital Output” on page 21-78

### Board Characteristics

|                                 |                |
|---------------------------------|----------------|
| Board name                      | CIO-DIO24H     |
| Manufacturer                    | ComputerBoards |
| Bus type                        | ISA            |
| Access method                   | I/O mapped     |
| Multiple block instance support | Yes            |
| Multiple board support          | Yes            |

### CIO-DIO24H Digital Input

The CIO-DIO24H has one 8255 chip with 3 ports (A,B,C). Each port has a maximum of 8 digital I/O lines that can be configured as inputs or outputs.

Use a separate driver block for each port. By selecting the digital input driver block, the port is configured as input.

### Scaling Input to Output

| Hardware Input | Block Output Data Type | Scaling                         |
|----------------|------------------------|---------------------------------|
| TTL            | Double                 | TTL low = 0.0<br>TTL high = 1.0 |

### Driver Block Parameters

**Channel vector** — Enter numbers between 1 and 8 to select the digital input lines used with this port. This driver allows the selection of individual digital input lines in any order. The number of elements defines the number of digital lines used.

For example, to use all of the digital inputs for one port, enter

```
[ 1, 2, 3, 4, 5, 6, 7, 8 ]
```

Number the lines beginning with 1 even if the board manufacturer starts numbering the lines with 0.

**Port** — From the list choose either A, B, or C. The I/O board has a 8255 chip with 3 ports. The **Port** parameter defines which port of the 8255 chip is used for this driver block. Each port has a maximum of 8 digital lines that can be configured as inputs or outputs depending on which driver block is chosen. In each case, one block is needed for each port.

**Sample time** — Enter a base sample time or a multiple of the base sample time.

**Base address** — Enter the base address of the board. This entry must correspond to the DIP switch settings on the board. For example, if the base address is 300 (hexadecimal), enter

```
0x300
```

### CIO-DIO24H Digital Output

The CIO-DIO24H has one 8255 chip with 3 ports (A,B,C). Each port has a maximum of 8 digital I/O lines that can be configured as inputs or outputs.

Use a separate driver block for each port. By selecting the digital output driver block, the port is configured as output.

### Scaling Input to Output

| Hardware Output | Block Input Data Type | Scaling                             |
|-----------------|-----------------------|-------------------------------------|
| TTL             | Double                | < 0.5 = TTL low<br>≥ 0.5 = TTL high |



## Driver Block Parameters

**Channel vector** — Enter numbers between 1 and 8 to select the digital output lines used with this port. This driver allows the selection of individual digital output lines in any order. The number of elements defines the number of digital lines used.

For example, to use all of the digital outputs for one port, enter

```
[ 1, 2, 3, 4, 5, 6, 7, 8 ]
```

Number the lines beginning with 1 even if the board manufacturer starts numbering the lines with 0.

**Port** — From the list choose either A, B, or C. The I/O board has a 8255 chip with 3 ports. The **Port** parameter defines which port of the 8255 chip is used for this driver block. Each port has a maximum of 8 digital lines that can be configured as inputs or outputs depending on which driver block is chosen. In each case, one block is needed for each port.

**Reset vector** — The reset vector controls the behavior of the channel at model termination. Enter a scalar or a vector that is the same length as the channel vector. If you specify a scalar value, that setting is used for all channels. If you specify a value of 1, the corresponding channel is reset to the value specified in the initial value vector. If you specify a value of 0, the channel remains at the last value attained while the model was running.

**Initial value vector** — The initial value vector contains the initial values (0 or 1) of the output channels. Enter a scalar or a vector that is the same length as the channel vector. If you enter a scalar, that value is used for all channels. The channels are set to these initial values between the time the model is downloaded and the time it is started.

**Sample time** — Enter a base sample time or a multiple of the base sample time.

**Base address** — Enter the base address of the board. This entry must correspond to the DIP switch settings on the board. For example, if the base address is 300 (hexadecimal), enter

```
0x300
```

## CIO-DIO48

The CIO-DIO48 is an I/O board with 48 digital I/O lines. xPC Target supports this board with these driver blocks:

- “CIO-DIO48 Digital Input” on page 21-80
- “CIO-DIO48 Digital Output” on page 21-81

### Board Characteristics

|                                 |                |
|---------------------------------|----------------|
| Board name                      | CIO-DIO48      |
| Manufacturer                    | ComputerBoards |
| Bus type                        | ISA            |
| Access method                   | I/O mapped     |
| Multiple block instance support | Yes            |
| Multiple board support          | Yes            |

### CIO-DIO48 Digital Input

The CIO-DIO48 has two 8255 chips (1,2). Each chip has three ports (A,B,C). Each port has a maximum of 8 digital I/O lines that can be configured as inputs or outputs.

Use a separate driver block for each port. By selecting the digital input driver block, the port is configured as input.

### Scaling Input to Output

| Hardware Input | Block Output Data Type | Scaling                         |
|----------------|------------------------|---------------------------------|
| TTL            | Double                 | TTL low = 0.0<br>TTL high = 1.0 |

## Driver Block Parameters

**Channel vector** — Enter numbers between 1 and 8 to select the digital input lines used with this port. This driver allows the selection of individual digital input lines in any order. The number of elements defines the number of digital lines used.

For example, to use all of the digital inputs for one port, enter

```
[ 1, 2, 3, 4, 5, 6, 7, 8]
```

Number the lines beginning with 1 even if the board manufacturer starts numbering the lines with 0.

**Port** — From the list choose either A, B, or C. The I/O board has two 8255 chips with 3 ports. The **Port** parameter defines which port of the 8255 chip is used for this driver block. Each port has a maximum of 8 digital lines that can be configured as inputs or outputs depending on which driver block is chosen. In each case, one block is needed for each port.

**Chip** — From the list choose 1 or 2. The **Chip** parameter defines which of the two 8255 chips is used.

**Sample time** — Enter a base sample time or a multiple of the base sample time.

**Base address** — Enter the base address of the board. This entry must correspond to the DIP switch settings on the board. For example, if the base address is 300 (hexadecimal), enter

```
0x300
```

## CIO-DIO48 Digital Output

The CIO-DIO48 has two 8255 chips (1,2). Each chip has three ports (A,B,C). Each port has a maximum of 8 digital I/O lines that can be configured as inputs or outputs.

Use a separate driver block for each port. By selecting the digital output driver block, the port is configured as output.

## Scaling Input to Output

| Hardware Output | Block Input Data Type | Scaling                             |
|-----------------|-----------------------|-------------------------------------|
| TTL             | Double                | < 0.5 = TTL low<br>≥ 0.5 = TTL high |

### Driver Block Parameters

**Channel vector** — Enter numbers between 1 and 8 to select the digital output lines used with this port. This driver allows the selection of individual digital output lines in any order. The number of elements defines the number of digital lines used.

For example, to use all of the digital outputs for one port, enter

```
[1,2,3,4,5,6,7,8]
```

Number the lines beginning with 1 even if the board manufacturer starts numbering the lines with 0.

**Port** — From the list choose either A, B, or C. The I/O board has two 8255 chips with 3 ports. The **Port** parameter defines which port of the 8255 chip is used for this driver block. Each port has a maximum of 8 digital lines that can be configured as inputs or outputs depending on which driver block is chosen. In each case, one block is needed for each port.

**Reset vector** — The reset vector controls the behavior of the channel at model termination. Enter a scalar or a vector that is the same length as the channel vector. If you specify a scalar value, that setting is used for all channels. If you specify a value of 1, the corresponding channel is reset to the value specified in the initial value vector. If you specify a value of 0, the channel remains at the last value attained while the model was running.

**Initial value vector** — The initial value vector contains the initial values (0 or 1) of the output channels. Enter a scalar or a vector that is the same length as the channel vector. If you enter a scalar, that value is used for all channels. The channels are set to these initial values between the time the model is downloaded and the time it is started.

**Chip** — From the list choose 1 or 2. The **Chip** parameter defines which of the two 8255 chips is used.

**Sample time** — Enter a base sample time or a multiple of the base sample time.

**Base address** — Enter the base address of the board. This entry must corresponds to the DIP switch settings on the board. For example, if the base address is 300 (hexadecimal), enter

0x300

## CIO-DIO48H

The CIO-DIO48H is an I/O board with 48 digital I/O lines.

xPC Target supports this board with these driver blocks:

- “CIO-DIO48H Digital Input” on page 21-84
- “CIO-DIO48H Digital Output” on page 21-86

### Board Characteristics

|                                 |                |
|---------------------------------|----------------|
| Board name                      | CIO-DIO48H     |
| Manufacturer                    | ComputerBoards |
| Bus type                        | ISA            |
| Access method                   | I/O mapped     |
| Multiple block instance support | Yes            |
| Multiple board support          | Yes            |

### CIO-DIO48H Digital Input

The CIO-DIO48H has two 8255 chips (1,2). Each chip has three ports (A,B,C). Each port has a maximum of 8 digital I/O lines that can be configured as inputs or outputs.

Use a separate driver block for each port. By selecting the digital input driver block, the port is configured as input.

### Scaling Input to Output

| Hardware Input | Block Output Data Type | Scaling                         |
|----------------|------------------------|---------------------------------|
| TTL            | Double                 | TTL low = 0.0<br>TTL high = 1.0 |

## Driver Block Parameters

**Channel vector** — Enter numbers between 1 and 8 to select the digital input lines used with this port. This driver allows the selection of individual digital input lines in any order. The number of elements defines the number of digital lines used.

For example, to use all of the digital inputs for one port, enter

```
[ 1, 2, 3, 4, 5, 6, 7, 8]
```

Number the lines beginning with 1 even if the board manufacturer starts numbering the lines with 0.

**Port** — From the list choose either A, B, or C. The I/O board has two 8255 chips with 3 ports. The **Port** parameter defines which port of the 8255 chip is used for this driver block. Each port has a maximum of 8 digital lines that can be configured as inputs or outputs depending on which driver block is chosen. In each case, one block is needed for each port.

**Chip** — From the list choose 1 or 2. The **Chip** parameter defines which of the two 8255 chips is used.

**Sample time** — Enter a base sample time or a multiple of the base sample time.

**Base address** — Enter the base address of the board. This entry must correspond to the DIP switch settings on the board. For example, if the base address is 300 (hexadecimal), enter

```
0x300
```

## CIO-DIO48H Digital Output

The CIO-DIO48H has two 8255 chips (1,2). Each chip has three ports (A,B,C). Each port has a maximum of 8 digital I/O lines that can be configured as inputs or outputs.

Use a separate driver block for each port. By selecting the digital output driver block, the port is configured as output.

### Scaling Input to Output

| Hardware Output | Block Input Data Type | Scaling                             |
|-----------------|-----------------------|-------------------------------------|
| TTL             | Double                | < 0.5 = TTL low<br>≥ 0.5 = TTL high |

### Driver Block Parameters

**Channel vector** — Enter numbers between 1 and 8 to select the digital output lines used with this port. This driver allows the selection of individual digital output lines in any order. The number of elements defines the number of digital lines used.

For example, to use all of the digital outputs for one port, enter

[ 1,2,3,4,5,6,7,8]

Number the lines beginning with 1 even if the board manufacturer starts numbering the lines with 0.

**Port** — From the list choose either A, B, or C. The I/O board has two 8255 chips with 3 ports. The **Port** parameter defines which port of the 8255 chip is used for this driver block. Each port has a maximum of 8 digital lines that can be configured as inputs or outputs depending on which driver block is chosen. In each case, one block is needed for each port.

**Reset vector** — The reset vector controls the behavior of the channel at model termination. Enter a scalar or a vector that is the same length as the channel vector. If you specify a scalar value, that setting is used for all channels. If you specify a value of 1, the corresponding channel is reset to the value specified in the initial value vector. If you specify a value of 0, the channel remains at the last value attained while the model was running.



**Initial value vector** — The initial value vector contains the initial values (0 or 1) of the output channels. Enter a scalar or a vector that is the same length as the channel vector. If you enter a scalar, that value is used for all channels. The channels are set to these initial values between the time the model is downloaded and the time it is started.

**Chip** — From the list choose 1 or 2. The **Chip** parameter defines which of the two 8255 chips is used.

**Sample time** — Enter a base sample time or a multiple of the base sample time.

**Base address** — Enter the base address of the board. This entry must correspond to the DIP switch settings on the board. For example, if the base address is 300 (hexadecimal), enter 0x300

## CIO-DIO96

The CIO-DIO96 is an I/O board with 96 digital I/O lines. xPC Target supports this board with these driver blocks:

- “CIO-DIO96 Digital Input” on page 21-88
- “CIO-DIO96 Digital Output” on page 21-89

### Board Characteristics

|                                 |                |
|---------------------------------|----------------|
| Board name                      | CIO-DIO96      |
| Manufacturer                    | ComputerBoards |
| Bus type                        | ISA            |
| Access method                   | I/O mapped     |
| Multiple block instance support | Yes            |
| Multiple board support          | Yes            |

### CIO-DIO96 Digital Input

The CIO-DIO96 has four 8255 chips (1,2,3,4). Each chip has three ports (A,B,C). Each port has a maximum of 8 digital I/O lines that can be configured as inputs or outputs.

Use a separate driver block for each port. By selecting the digital input driver block, the port is configured as input.

### Scaling Input to Output

| Hardware Input | Block Output Data Type | Scaling                         |
|----------------|------------------------|---------------------------------|
| TTL            | Double                 | TTL low = 0.0<br>TTL high = 1.0 |

## Driver Block Parameters

**Channel vector** — Enter numbers between 1 and 8 to select the digital input lines used with this port. This driver allows the selection of individual digital input lines in any order. The number of elements defines the number of digital lines used.

For example, to use all of the digital inputs for one port, enter

```
[ 1, 2, 3, 4, 5, 6, 7, 8]
```

Number the lines beginning with 1 even if the board manufacturer starts numbering the lines with 0.

**Port** — From the list choose either A, B, or C. The I/O board has two 8255 chips with 3 ports. The **Port** parameter defines which port of the 8255 chip is used for this driver block. Each port has a maximum of 8 digital lines that can be configured as inputs or outputs depending on which driver block is chosen. In each case, one block is needed for each port.

**Chip** — From the list choose 1, 2, 3, or 4. The **Chip** parameter defines which of the four 8255 chips is used.

**Sample time** — Enter a base sample time or a multiple of the base sample time.

**Base address** — Enter the base address of the board. This entry must correspond to the DIP switch settings on the board. For example, if the base address is 300 (hexadecimal), enter

```
0x300
```

## CIO-DIO96 Digital Output

The CIO-DIO96 has four 8255 chips (1,2,3,4). Each chip has three ports (A,B,C). Each port has a maximum of 8 digital I/O lines that can be configured as inputs or outputs.

Use a separate driver block for each port. By selecting the digital output driver block, the port is configured as output.

## Scaling Input to Output

| Hardware Output | Block Input Data Type | Scaling                             |
|-----------------|-----------------------|-------------------------------------|
| TTL             | Double                | < 0.5 = TTL low<br>≥ 0.5 = TTL high |

### Driver Block Parameters

**Channel vector** — Enter numbers between 1 and 8 to select the digital output lines used with this port. This driver allows the selection of individual digital output lines in any order. The number of elements defines the number of digital lines used.

For example, to use all of the digital outputs for one port, enter

```
[1,2,3,4,5,6,7,8]
```

Number the lines beginning with 1 even if the board manufacturer starts numbering the lines with 0.

**Port** — From the list choose either A, B, or C. The I/O board has two 8255 chips with 3 ports. The **Port** parameter defines which port of the 8255 chip is used for this driver block. Each port has a maximum of 8 digital lines that can be configured as inputs or outputs depending on which driver block is chosen. In each case, one block is needed for each port.

**Reset vector** — The reset vector controls the behavior of the channel at model termination. Enter a scalar or a vector that is the same length as the channel vector. If you specify a scalar value, that setting is used for all channels. If you specify a value of 1, the corresponding channel is reset to the value specified in the initial value vector. If you specify a value of 0, the channel remains at the last value attained while the model was running.

**Initial value vector** — The initial value vector contains the initial values (0 or 1) of the output channels. Enter a scalar or a vector that is the same length as the channel vector. If you enter a scalar, that value is used for all channels. The channels are set to these initial values between the time the model is downloaded and the time it is started.

**Chip** — From the list choose 1, 2, 3, or 4. The **Chip** parameter defines which of the four 8255 chips is used.

**Sample time** — Enter a base sample time or a multiple of the base sample time.

**Base address** — Enter the base address of the board. This entry must corresponds to the DIP switch settings on the board. For example, if the base address is 300 (hexadecimal), enter

0x300

## CIO-DIO192

The CIO - DIO192 is an I/O board with 192 digital I/O lines.

xPC Target supports this board with these driver blocks:

- “CIO-DIO192 Digital Input” on page 21-92
- “CIO-DIO192 Digital Output” on page 21-93

### Board Characteristics

|                                 |                |
|---------------------------------|----------------|
| Board name                      | CIO-DIO192     |
| Manufacturer                    | ComputerBoards |
| Bus type                        | ISA            |
| Access method                   | I/O mapped     |
| Multiple block instance support | Yes            |
| Multiple board support          | Yes            |

### CIO-DIO192 Digital Input

The CIO-DIO96 has eight 8255 chips (1,2,3,4,5,6,7,8). Each chip has three ports (A,B,C). Each port has a maximum of 8 digital I/O lines that can be configured as inputs or outputs.

Use a separate driver block for each port. By selecting the digital input driver block, the port is configured as input.

### Scaling Input to Output

| Hardware Input | Block Output Data Type | Scaling                         |
|----------------|------------------------|---------------------------------|
| TTL            | Double                 | TTL low = 0.0<br>TTL high = 1.0 |

### Driver Block Parameters

**Channel vector** — Enter numbers between 1 and 8 to select the digital input lines used with this port. This driver allows the selection of individual digital input lines in any order. The number of elements defines the number of digital lines used.

For example, to use all of the digital inputs for one port, enter

```
[ 1, 2, 3, 4, 5, 6, 7, 8]
```

Number the lines beginning with 1 even if the board manufacturer starts numbering the lines with 0.

**Port** — From the list choose either A, B, or C. The I/O board has two 8255 chips with 3 ports. The **Port** parameter defines which port of the 8255 chip is used for this driver block. Each port has a maximum of 8 digital lines that can be configured as inputs or outputs depending on which driver block is chosen. In each case, one block is needed for each port.

**Chip** — From the list choose 1, 2, 3, 4, 5, 6, 7, or 8. The **Chip** parameter defines which of the eight 8255 chips is used.

**Sample time** — Enter a base sample time or a multiple of the base sample time.

**Base address** — Enter the base address of the board. This entry must correspond to the DIP switch settings on the board. For example, if the base address is 300 (hexadecimal), enter

```
0x300
```

### CIO-DIO192 Digital Output

The CIO-DIO192 has eight 8255 chips (1,2,3,4,5,6,7,8). Each chip has three ports (A,B,C). Each port has a maximum of 8 digital I/O lines that can be configured as inputs or outputs.

Use a separate driver block for each port. By selecting the digital output driver block, the port is configured as output.

## Scaling Input to Output

| Hardware Output | Block Input Data Type | Scaling                             |
|-----------------|-----------------------|-------------------------------------|
| TTL             | Double                | < 0.5 = TTL low<br>≥ 0.5 = TTL high |

### Driver Block Parameters

**Channel vector** — Enter numbers between 1 and 8 to select the digital output lines used with this port. This driver allows the selection of individual digital output lines in any order. The number of elements defines the number of digital lines used.

For example, to use all of the digital outputs for one port, enter

```
[ 1,2,3,4,5,6,7,8]
```

Number the lines beginning with 1 even if the board manufacturer starts numbering the lines with 0.

**Port** — From the list choose either A, B, or C. The I/O board has two 8255 chips with 3 ports. The **Port** parameter defines which port of the 8255 chip is used for this driver block. Each port has a maximum of 8 digital lines that can be configured as inputs or outputs depending on which driver block is chosen. In each case, one block is needed for each port.

**Reset vector** — The reset vector controls the behavior of the channel at model termination. Enter a scalar or a vector that is the same length as the channel vector. If you specify a scalar value, that setting is used for all channels. If you specify a value of 1, the corresponding channel is reset to the value specified in the initial value vector. If you specify a value of 0, the channel remains at the last value attained while the model was running.

**Initial value vector** — The initial value vector contains the initial values (0 or 1) of the output channels. Enter a scalar or a vector that is the same length as the channel vector. If you enter a scalar, that value is used for all channels. The channels are set to these initial values between the time the model is downloaded and the time it is started.

**Chip** — From the list choose 1, 2, 3, 4, 5, 6, 7, or 8. The **Chip** parameter defines which of the eight 8255 chips is used.



**Sample time** — Enter a base sample time or a multiple of the base sample time.

**Base address** — Enter the base address of the board. This entry must corresponds to the DIP switch settings on the board. For example, if the base address is 300 (hexadecimal), enter

0x300

## CIO-DO24DD

The CIO-DO24DD is an I/O board with 24 open-collector digital output lines. xPC Target supports this board with this driver block:

- “CIO-DO24DD Digital Output” on page 21-96

### Board Characteristics

|                                 |                |
|---------------------------------|----------------|
| Board name                      | CIO-DO24DD     |
| Manufacturer                    | ComputerBoards |
| Bus type                        | ISA            |
| Access method                   | I/O mapped     |
| Multiple block instance support | Yes            |
| Multiple board support          | Yes            |

### CIO-DO24DD Digital Output

The CIO-DIO24DD has one 8255 chip with 3 ports (A,B,C). Each port has a maximum of 8 digital I/O lines that are configured as outputs.

Use a separate driver block for each port. By selecting the digital output driver block, the port is configured as output.

### Scaling Input to Output

| Hardware Output | Block Input Data Type | Scaling                             |
|-----------------|-----------------------|-------------------------------------|
| TTL             | Double                | < 0.5 = TTL low<br>≥ 0.5 = TTL high |

### Driver Block Parameters

**Channel vector** — Enter numbers between 1 and 8 to select the digital output lines used with this port. This driver allows the selection of individual digital output lines in any order. The number of elements defines the number of digital lines used.

For example, to use all of the digital outputs for one port, enter

```
[1,2,3,4,5,6,7,8]
```

Number the lines beginning with 1 even if the board manufacturer starts numbering the lines with 0.

**Port** — From the list choose either A, B, or C. The I/O board has a 8255 chip with 3 ports. The **Port** parameter defines which port of the 8255 chip is used for this driver block. Each port has a maximum of 8 digital lines that can be configured as inputs or outputs depending on which driver block is chosen. In each case, one block is needed for each port.

**Reset vector** — The reset vector controls the behavior of the channel at model termination. Enter a scalar or a vector that is the same length as the channel vector. If you specify a scalar value, that setting is used for all channels. If you specify a value of 1, the corresponding channel is reset to the value specified in the initial value vector. If you specify a value of 0, the channel remains at the last value attained while the model was running.

**Initial value vector** — The initial value vector contains the initial values (0 or 1) of the output channels. Enter a scalar or a vector that is the same length as the channel vector. If you enter a scalar, that value is used for all channels. The channels are set to these initial values between the time the model is downloaded and the time it is started.

**Sample time** — Enter a base sample time or a multiple of the base sample time.

**Base address** — Enter the base address of the board. This entry must correspond to the DIP switch settings on the board. For example, if the base address is 300 (hexadecimal), enter

```
0x300
```

## CIO-PDISO16

The CIO-PDISO16 is an I/O board with 16 isolated digital input lines and 16 relay driven digital output lines.

xPC Target supports this board with these driver blocks:

- “CIO-PDISO16 Digital Input” on page 21-98
- “CIO-PDISO16 Digital Output” on page 21-99

---

**Note** xPC Target does not support the 16 relays on this board.

---

### Board Characteristics

|                                 |                |
|---------------------------------|----------------|
| Board name                      | CIO-PDISO16    |
| Manufacturer                    | ComputerBoards |
| Bus type                        | ISA            |
| Access method                   | I/O mapped     |
| Multiple block instance support | Yes            |
| Multiple board support          | Yes            |

### CIO-PDISO16 Digital Input

The CIO-PDISO16 has two independent connectors. Each connector has 8 digital input lines.

Use a separate driver block for each connector.

### Scaling Input to Output

| Hardware Input      | Block Output Data Type | Scaling                               |
|---------------------|------------------------|---------------------------------------|
| 5 to 24 volts DC/AC | Double                 | ~0 volts = 0.0<br>5 to 24 volts = 1.0 |

### Driver Block Parameters

**Number of Channels** — Enter a number between 1 and 8 to select the number of digital input lines used with this connector. This driver does not allow the selection of individual digital input lines.

**Section(Connector)** — From the list, choose either 1 (nearest to backplate) or 2 (farthest from backplate to select the connector used).

**Sample time** — Enter the base sample time or a multiple of the base sample time.

**Base address** — Enter the base address of the board. It is important that this entry corresponds to the DIP switch settings on the board. For example, if the base address is 300 (hexadecimal), enter

0x300

The Wait-State jumper has to be in the off position.

The switch and jumper settings, that are not mentioned here, have no influence on the running of xPC Target.

### CIO-PDISO16 Digital Output

The CIO-PDISO16 has two independent connectors. Each connector has 8 relay driven digital input lines.

Use a separate driver block for each connector.

### Scaling Input to Output

| Hardware Output | Block Input Data Type | Scaling                                    |
|-----------------|-----------------------|--------------------------------------------|
| relay           | Double                | < 0.5 = Relay open<br>≥ 0.5 = Relay closed |

### Driver Block Parameters

**Number of Channels** — Enter a number between 1 and 8 to select the number of digital output lines used with this connector. This driver does not allow the selection of individual digital output lines.

**Section(Connector)** — From the list, choose either 1 (nearest to backplate) or 2 (farthest from backplate to select the connector used).

**Sample time** — Enter the base sample time or a multiple of the base sample time.

**Base address** — Enter the base address of the board. It is important that this entry corresponds to the DIP switch settings on the board. For example, if the base address is 300 (hexadecimal), enter

0x300

The Wait-State jumper has to be in the off position.

The switch and jumper settings, that are not mentioned here, have no influence on the running of xPC Target.

## CIO-QUAD02

The CIO-QUAD02 is a 24-bit counting board with 2 channels. This board typically connects to incremental encoders. Incremental encoders convert physical motion into electrical pulses that can be used to determine velocity, direction, and distance.

xPC Target supports this board with this driver block:

- “CIO-QUAD02 Incremental Encoder” on page 21-101

See “CIO-QUAD02 Incremental Encoder (Obsolete)” on page 21-106 if you have an earlier version of this driver.

### Board Characteristics

|                                 |                |
|---------------------------------|----------------|
| Board name                      | CIO-QUAD02     |
| Manufacturer                    | ComputerBoards |
| Bus type                        | ISA            |
| Access method                   | I/O mapped     |
| Multiple block instance support | Yes            |
| Multiple board support          | Yes            |

### CIO-QUAD02 Incremental Encoder

This driver block has one block output: **Count**.

The raw count value is a 24-bit integer that is converted to a double precision float output from the block. The 24-bit value can be interpreted in different ways (see **Count Range**).

In this section, the clockwise direction is the direction in which the counter increments. The counterclockwise direction is the direction in which the counter decrements. Note that the counter direction depends on the encoder manufacturer and the way in which the encoder is installed.

---

**Note** If you are using an earlier version of this driver block, see “CIO-QUAD02 Incremental Encoder (Obsolete)” on page 21-106.

---

## Driver Block Parameters

**Channel** — From the list, choose 1, 2, 3, or 4. This parameter specifies the channel you use for this block. For the same board (same base address) two blocks cannot have the same channel number.

**Index input resets counter** — Choose this check box to control the behavior when the index is reached. For example, a rotary encoder typically reaches the index at one particular position in its range of motion. Setting this check box to reset the count value allows you to get a repeatable position from an encoder. When the encoder reaches the index (asserts the index), the counter value is set to the value given in the **Count Limit or Reset Value** field.

**Index Polarity** — From the list, select the index pulse slope that the board should detect. Select **Positive Index** for a positive slope; select **Negative Index** for a negative slope.

**Counting Mode** — From the list, select a counting mode (**Normal**, **Range Limit**, **Non-recycle**, or **Modulo-N**). The output of the block depends on both the setting of **Index input resets counter** and on the counting mode as described in the following table.



| <b>Counting Mode</b> | <b>Index input resets counter Selected</b>                                                                                                                                                                                                                                                                                                                                                                                                                                                                                                                                                                    | <b>Index input resets counter Deselected</b>                                                                                                                                                                                                                                                                                                                                      |
|----------------------|---------------------------------------------------------------------------------------------------------------------------------------------------------------------------------------------------------------------------------------------------------------------------------------------------------------------------------------------------------------------------------------------------------------------------------------------------------------------------------------------------------------------------------------------------------------------------------------------------------------|-----------------------------------------------------------------------------------------------------------------------------------------------------------------------------------------------------------------------------------------------------------------------------------------------------------------------------------------------------------------------------------|
| Normal               | <p>Upon model start, the output count is initialized to <b>Count Limit or Reset Value</b>. The output count increments or decrements one full revolution from the <b>Count Limit or Reset Value</b>. The output count is reset to this value each time the index is reached.</p> <p>For example, if <b>Index input resets counter</b> is selected, and a rotary encoder has 1024 counts per revolution, and a <b>Count Limit or Reset Value</b> value of 5000, a full clockwise revolution of the encoder increments the counter to 6023, at which the index is reached. The counter then resets to 5000.</p> | <p>Upon model start, the counter is initialized to 0. The counter then increments or decrements until it either overflows or underflows. For a rotary encoder, the number of revolutions is the number of output counts divided by the number of counts per revolution. The resulting integer is the number of revolutions; the fractional part can be converted to an angle.</p> |

| <b>Counting Mode</b> | <b>Index input resets counter Selected</b>                                                                                                                                                                                                                                                                                                                                                                                                                                                                                                                            | <b>Index input resets counter Deselected</b>                                                                                                                                                                                                                                                                                                                                                                                                                                                                                                                     |
|----------------------|-----------------------------------------------------------------------------------------------------------------------------------------------------------------------------------------------------------------------------------------------------------------------------------------------------------------------------------------------------------------------------------------------------------------------------------------------------------------------------------------------------------------------------------------------------------------------|------------------------------------------------------------------------------------------------------------------------------------------------------------------------------------------------------------------------------------------------------------------------------------------------------------------------------------------------------------------------------------------------------------------------------------------------------------------------------------------------------------------------------------------------------------------|
| Range Limit          | <p>Upon model start, the counter increments or decrements until it reaches the count limit <b>Count Limit or Reset Value</b>. If the clock motion is clockwise, the counter stays at <b>Count Limit or Reset Value</b> once it reaches that value. If the clock motion is counterclockwise, the counter decrements one revolution then resets to <b>Count Limit or Reset Value</b>.</p>                                                                                                                                                                               | <p>Upon model start, the counter is initialized to 0. In the clockwise direction, the counter increments until it saturates at <b>Count Limit or Reset Value</b>. In the counterclockwise direction, the counter decrements until it saturates at 0.</p> <p>You can use this setting to set a repeatable 0 when there is a mechanical stop. At model start, the count is initialized to 0. The machine then shifts to the negative direction stop. At that point, the encoder reports 0 at the stop and all other positions will be positive and repeatable.</p> |
| Non-recycle          | <p>Upon model start, the counter is initialized to <b>Count Limit or Reset Value</b>. With counterclockwise rotation, the counter decrements and saturates at 0. If the encoder reaches the index before the counter saturates at 0, the counter resets to <b>Count Limit or Reset Value</b>. With clockwise rotation, the counter increments until the encoder reaches the index. When the encoder reaches the index, the counter resets to <b>Count Limit or Reset Value</b>. You can use this setting to place 0 at the first index inside a mechanical limit.</p> | <p>The behavior of this option is undefined.</p>                                                                                                                                                                                                                                                                                                                                                                                                                                                                                                                 |

| Counting Mode | Index input resets counter Selected       | Index input resets counter Deselected                                                                                                                                                                                                                                                                                                                                                                                                                  |
|---------------|-------------------------------------------|--------------------------------------------------------------------------------------------------------------------------------------------------------------------------------------------------------------------------------------------------------------------------------------------------------------------------------------------------------------------------------------------------------------------------------------------------------|
| Modulo-N      | The behavior of this option is undefined. | Upon model start, the counter is initialized to 0. In the clockwise direction, the counter increments to <b>Count Limit or Reset Value</b> , then resets to 0 and repeats. When the counter decrements, it counts to 0, then resets to the <b>Count Limit or Reset Value</b> value and continues to decrement. You can use this setting to repeat intervals that do not match the distance between indexes (resulting, for example, from gear ratios). |

**Count Limit or Reset Value** — The preset register (PR) on the counter chip is a 24-bit quantity. The counter uses this value as a limit for the **Range Limit**, **Non-recycle**, and **Modulo-N** counting modes.

When **Index input resets counter** is selected, this value acts as both the initial value at model start and the value that an index resets the count to.

You can enter negative limit values, but the counter treats them as large positive values. For example, a limit of -1 results in the **Modulo-N** range from 0 to  $2^{24} - 1$ , not from -1 to 0.

**Count Range** — From the list, choose  $0 \dots 2^{24} - 1$  or  $-2^{23} \dots +2^{23} - 1$ . The counter uses a 24-bit accumulator which overflows from  $2^{24} - 1$  to 0. This same overflow can be interpreted as the transition from -1 to 0. Selecting the unipolar range  $0$  to  $2^{24} - 1$  puts the discontinuity in counts at 0. Selecting the bipolar range of  $(-2)^{23}$  to  $2^{23} - 1$  puts the discontinuity far away from 0. The bipolar range is achieved by sign extending the 24-bit count to 32 bits before converting to double.

**Count Speed** — From the list, choose non-quadrature, 1X, 2X, or 4X:

- non-quadrature — Counts the rising edges of the A input, losing direction information in the process. The presence of a quadrature signal on the B

input might cause undefined results. You should disconnect the B and index inputs.

- 1X — Counts up or down once per complete cycle of the quadrature signal.
- 2X — Counts up or down twice per complete cycle of the quadrature signal.
- 4X — Counts up or down four times per complete cycle of the quadrature signal.

**Filter prescale factor** — Enter a base prescale factor for digital filtering. This filter helps eliminate high frequency noise. Enter a value from 0 to ff in hexadecimal (0 to 256 in decimal). For example, for a prescale factor value of ff in hexadecimal, enter

```
0xff
```

**Sample Time** — Enter a base sample time or a multiple of the base sample time. The sample time indicates the update rate of registration on the input (Duty Cycle). Enter -1 to inherit the model sample time from another block. The sample time is in seconds.

**Base Address** — Enter the base address of the board. It is important that this entry corresponds to the DIP switch settings on the board. For example, if the base address is 300 (hexadecimal), enter

```
0x300
```

## **CIO-QUAD02 Incremental Encoder (Obsolete)**

This driver block has three block outputs: **Angle**, **Turns**, and **Init**.

You can use **Init** to determine when the block output values are valid. **Init** is first set to 0. When the encoder reached the first index, **Init** is set to 1. From then on, you can determine the exact position, direction, and velocity. **Init** remains 1 unless **Counter Reset by Index** is set to **First Only**, and the counter detects a rollover. For more information, see “Driver Block Parameters” on page 21-107.

**Turns** is the number of complete revolutions made by the encoder. **Angle** is the amount the encoder turns since the last full revolution.

The distance is given by:

$$\text{distance} = 2 * \pi * \text{Turns} + \text{Angle}$$

The velocity is given by:

$$\text{velocity} = (\text{distance}(t_s) - \text{distance}(t_{s-1})) / t_s$$

The direction is given by:

$$\text{direction} = \text{distance}(t_s) - \text{distance}(t_{s-1})$$

A negative value is reverse, while a positive value is forward.

### Driver Block Parameters

**Function module** — From the list choose 1 or 2. This parameter specifies which channel you use for this block. For the same board (same base address) two blocks cannot have the same channel number.

**Counter Reset by Index** — From the list choose either `Only First`, or `Continuous`.

If you choose `Only First`, the first time the encoder reaches the index, the counter is reset to zero, the **Init** output signal is set to 1, and the encoder begins to count. The encoder ignores all other times it reaches the index. **Init** remains 1 until a rollover is detected, and then set to -1. A rollover is when the counter reaches its maximum value and begins to start counting at zero again. A rollover can also occur when the counter reaches its minimum value and the counter resets itself to the maximum value and resumes counting down. The outputs are still accurate after rollover. The -1 flag is used to alert that a rollover has occurred.

If you choose `Continuous`, the first time the encoder reaches the index, the counter is reset to zero, the **Init** output signal is set to 1, and the encoder begins to count. Each time the encoder reaches the index, it resets to zero. **Init** remains always at 1 because a rollover cannot occur.

**Positive Rotation** — From the list, choose either `Clockwise` or `Counter Clockwise`. This parameter sets the direction for positive rotation. If you choose `Clockwise`, when the encoder is turned clockwise it counts up, and when turned counter clockwise it counts down. If you choose `Counter Clockwise` the counting direction is reversed.

**Mode** — From the list, choose `Single`, `Double`, or `Quadruple`. This parameter specifies the phase detection mode. That is, how many phase changes are detected. For more information, see the board manual.

**Resolution** — This field specifies the divisions of the connected incremental encoder for one revolution.

**Filter prescale factor** — Enter a base prescale factor for digital filtering. This filter helps eliminate high frequency noise. Enter a value from 0 to ff in hexadecimal (0 to 256 in decimal). For example, for a prescale factor value of ff in hexadecimal, enter

0xff

**Sample Time** — Enter a base sample time or a multiple of the base sample time. The sample time indicates the update rate of registration on the input (Duty Cycle). Enter -1 to inherit the model sample time from another block. The sample time is in seconds.

**Base Address** — Enter the base address of the board. It is important that this entry corresponds to the DIP switch settings on the board. For example, if the base address is 300 (hexadecimal), enter

0x300

## CIO-QUAD04

The CIO-QUAD04 is a 24-bit counting board with 4 channels. This board typically connects to incremental encoders. Incremental encoders convert physical motion into electrical pulses that can be used to determine velocity, direction, and distance.

xPC Target supports this board with this driver block:

- “CIO-QUAD04 Incremental Encoder” on page 21-110

See “CIO-QUAD04 Incremental Encoder (Obsolete)” on page 21-114 if you have an earlier version of this driver.

Note on usage:

There is a hardware limitation with the CIO-Quad04 boards in the way that they handle unconnected inputs. Even with the **Index input resets counter** check box disabled, noise on the index input line might cause the counter chip on the board to latch an incorrect value. This value differs from the correct value by a multiple of 256. The frequency of occurrence of the bad reads depends on the count frequency coming from the encoder. High count rates result in more bad reads.

To work around this issue, try the following:

- 1 If the index signal from an encoder is not being used, connect the index inputs.
- 2 Connect the index+ input to +5 volts.
- 3 Connect the index- input to ground.

These connections should be made as close to the board as possible to minimize any crosstalk at high count frequencies.

### Board Characteristics

|                                 |                |
|---------------------------------|----------------|
| Board name                      | CIO-QUAD04     |
| Manufacturer                    | ComputerBoards |
| Bus type                        | ISA            |
| Access method                   | I/O mapped     |
| Multiple block instance support | Yes            |
| Multiple board support          | Yes            |

### CIO-QUAD04 Incremental Encoder

This driver block has one block output: **Count**.

The raw count value is a 24-bit integer that is converted to a double precision float output from the block. The 24-bit value can be interpreted in different ways (see **Count Range**).

In this section, the clockwise direction is the direction in which the counter increments. The counterclockwise direction is the direction in which the counter decrements. Note that the counter direction depends on the encoder manufacturer and the way in which the encoder is installed.

---

**Note** If you are using an earlier version of this driver block, see “CIO-QUAD04 Incremental Encoder (Obsolete)” on page 21-114.

---

### Driver Block Parameters

**Channel** — From the list, choose 1, 2, 3, or 4. This parameter specifies the channel you use for this block. For the same board (same base address) two blocks cannot have the same channel number.

**Index input resets counter** — Choose this check box to control the behavior when the index is reached. For example, a rotary encoder typically reaches the index at one particular position in its range of motion. Setting this check box to reset the count value allows you to get a repeatable position from an encoder. When the encoder reaches the index (asserts the index), the counter value is set to the value given in the **Count Limit or Reset Value** field.



**Index Polarity** — From the list, select the index pulse slope that the board should detect. Select **Positive Index** for a positive slope; select **Negative Index** for a negative slope.

**Counting Mode** — From the list, select a counting mode (Normal, Range Limit, Non-recycle, or Modulo-N). The output of the block depends on both the setting of **Index input resets counter** and on the counting mode as described in the following table.

| <b>Counting Mode</b> | <b>Index input resets counter Selected</b>                                                                                                                                                                                                                                                                                                                                                                                                                                                                                                                                                                    | <b>Index input resets counter Deselected</b>                                                                                                                                                                                                                                                                                                                                      |
|----------------------|---------------------------------------------------------------------------------------------------------------------------------------------------------------------------------------------------------------------------------------------------------------------------------------------------------------------------------------------------------------------------------------------------------------------------------------------------------------------------------------------------------------------------------------------------------------------------------------------------------------|-----------------------------------------------------------------------------------------------------------------------------------------------------------------------------------------------------------------------------------------------------------------------------------------------------------------------------------------------------------------------------------|
| Normal               | <p>Upon model start, the output count is initialized to <b>Count Limit or Reset Value</b>. The output count increments or decrements one full revolution from the <b>Count Limit or Reset Value</b>. The output count is reset to this value each time the index is reached.</p> <p>For example, if <b>Index input resets counter</b> is selected, and a rotary encoder has 1024 counts per revolution, and a <b>Count Limit or Reset Value</b> value of 5000, a full clockwise revolution of the encoder increments the counter to 6023, at which the index is reached. The counter then resets to 5000.</p> | <p>Upon model start, the counter is initialized to 0. The counter then increments or decrements until it either overflows or underflows. For a rotary encoder, the number of revolutions is the number of output counts divided by the number of counts per revolution. The resulting integer is the number of revolutions; the fractional part can be converted to an angle.</p> |

| <b>Counting Mode</b> | <b>Index input resets counter Selected</b>                                                                                                                                                                                                                                                                                                                                                                                                                                                                                                                            | <b>Index input resets counter Deselected</b>                                                                                                                                                                                                                                                                                                                                                                                                                                                                                                                     |
|----------------------|-----------------------------------------------------------------------------------------------------------------------------------------------------------------------------------------------------------------------------------------------------------------------------------------------------------------------------------------------------------------------------------------------------------------------------------------------------------------------------------------------------------------------------------------------------------------------|------------------------------------------------------------------------------------------------------------------------------------------------------------------------------------------------------------------------------------------------------------------------------------------------------------------------------------------------------------------------------------------------------------------------------------------------------------------------------------------------------------------------------------------------------------------|
| Range Limit          | <p>Upon model start, the counter increments or decrements until it reaches the count limit <b>Count Limit or Reset Value</b>. If the clock motion is clockwise, the counter stays at <b>Count Limit or Reset Value</b> once it reaches that value. If the clock motion is counterclockwise, the counter decrements one revolution then resets to <b>Count Limit or Reset Value</b>.</p>                                                                                                                                                                               | <p>Upon model start, the counter is initialized to 0. In the clockwise direction, the counter increments until it saturates at <b>Count Limit or Reset Value</b>. In the counterclockwise direction, the counter decrements until it saturates at 0.</p> <p>You can use this setting to set a repeatable 0 when there is a mechanical stop. At model start, the count is initialized to 0. The machine then shifts to the negative direction stop. At that point, the encoder reports 0 at the stop and all other positions will be positive and repeatable.</p> |
| Non-recycle          | <p>Upon model start, the counter is initialized to <b>Count Limit or Reset Value</b>. With counterclockwise rotation, the counter decrements and saturates at 0. If the encoder reaches the index before the counter saturates at 0, the counter resets to <b>Count Limit or Reset Value</b>. With clockwise rotation, the counter increments until the encoder reaches the index. When the encoder reaches the index, the counter resets to <b>Count Limit or Reset Value</b>. You can use this setting to place 0 at the first index inside a mechanical limit.</p> | <p>The behavior of this option is undefined.</p>                                                                                                                                                                                                                                                                                                                                                                                                                                                                                                                 |

| Counting Mode | Index input resets counter Selected       | Index input resets counter Deselected                                                                                                                                                                                                                                                                                                                                                                                                                  |
|---------------|-------------------------------------------|--------------------------------------------------------------------------------------------------------------------------------------------------------------------------------------------------------------------------------------------------------------------------------------------------------------------------------------------------------------------------------------------------------------------------------------------------------|
| Modulo-N      | The behavior of this option is undefined. | Upon model start, the counter is initialized to 0. In the clockwise direction, the counter increments to <b>Count Limit or Reset Value</b> , then resets to 0 and repeats. When the counter decrements, it counts to 0, then resets to the <b>Count Limit or Reset Value</b> value and continues to decrement. You can use this setting to repeat intervals that do not match the distance between indexes (resulting, for example, from gear ratios). |

**Count Limit or Reset Value** — The preset register (PR) on the counter chip is a 24-bit quantity. The counter uses this value as a limit for the **Range Limit**, **Non-recycle**, and **Modulo-N** counting modes.

When **Index input resets counter** is selected, this value acts as both the initial value at model start and the value that an index resets the count to.

You can enter negative limit values, but the counter treats them as large positive values. For example, a limit of -1 results in the **Modulo-N** range from 0 to  $2^{24} - 1$ , not from -1 to 0.

**Count Range** — From the list, choose  $0 \dots 2^{24} - 1$  or  $-2^{23} \dots +2^{23} - 1$ . The counter uses a 24-bit accumulator which overflows from  $2^{24} - 1$  to 0. This same overflow can be interpreted as the transition from -1 to 0. Selecting the unipolar range  $0$  to  $2^{24} - 1$  puts the discontinuity in counts at 0. Selecting the bipolar range of  $(-2)^{23}$  to  $2^{23} - 1$  puts the discontinuity far away from 0. The bipolar range is achieved by sign extending the 24-bit count to 32 bits before converting to double.

**Count Speed** — From the list, choose non-quadrature, 1X, 2X, or 4X:

- non-quadrature — Counts the rising edges of the A input, losing direction information in the process. The presence of a quadrature signal on the B input might cause undefined results. You should disconnect the B and index inputs.
- 1X — Counts up or down once per complete cycle of the quadrature signal.
- 2X — Counts up or down twice per complete cycle of the quadrature signal.
- 4X — Counts up or down four times per complete cycle of the quadrature signal.

**Filter prescale factor** — Enter a base prescale factor for digital filtering. This filter helps eliminate high frequency noise. Enter a value from 0 to ff in hexadecimal (0 to 256 in decimal). For example, for a prescale factor value of ff in hexadecimal, enter

0xff

**Sample time** — Enter a base sample time or a multiple of the base sample time. The sample time indicates the update rate of registration on the input (Duty Cycle). Enter -1 to inherit the model sample time from another block. The sample time is in seconds.

**Base address** — Enter the base address of the board. It is important that this entry corresponds to the DIP switch settings on the board. For example, if the base address is 300 (hexadecimal), enter

0x300

## **CIO-QUAD04 Incremental Encoder (Obsolete)**

This driver block has three block outputs: **Angle**, **Turns**, and **Init**.

You can use **Init** to determine when the block output values are valid. **Init** is first set to 0. When the encoder reached the first index, **Init** is set to 1. From then on, you can determine the exact position, direction, and velocity. **Init** remains 1 unless **Counter Reset by Index** is set to **First Only**, and the counter detects a rollover. For more information, see “Driver Block Parameters” on page 21-107.

**Turns** is the number of complete revolutions made by the encoder. **Angle** is the amount the encoder turns since the last full revolution.

The distance is given by:

$$\text{distance} = 2 * \text{pi} * \text{Turns} + \text{Angle}$$

The velocity is given by:

$$\text{velocity} = (\text{distance}(t_s) - \text{distance}(t_s-1)) / t_s$$

The direction is given by:

$$\text{direction} = \text{distance}(t_s) - \text{distance}(t_s-1)$$

A negative value is reverse, while a positive value is forward.

### Driver Block Parameters

**Function module** — From the list choose, **1**, **2**, **3**, or **4**. This parameter specifies which channel you use for this block. For the same board (same base address) two blocks cannot have the same channel number.

**Counter Reset by Index** — From the list choose either **Only First**, or **Continuous**.

If you choose **Only First**, the first time the encoder reaches the index, the counter is reset to zero, the **Init** output signal is set to 1, and the encoder begins to count. The encoder ignores all other times it reaches the index. **Init** remains 1 until a rollover is detected, and then set to -1. A rollover is when the counter reaches its maximum value and begins to start counting at zero again. A rollover can also occur when the counter reaches its minimum value and the counter resets itself to the maximum value and resumes counting down. The outputs are still accurate after rollover. The -1 flag is used to alert that a rollover has occurred.

If you choose **Continuous**, The first time the encoder reaches the index, the counter is reset to zero, the **Init** output signal is set to 1, and the encoder begins to count. Each time the encoder reaches the index, it resets to zero. **Init** remains always at 1 because a rollover cannot occur.

**Positive Rotation** — From the list, choose either **Clockwise** or **Counter Clockwise**. This parameter sets the direction for positive rotation. If you choose **Clockwise**, when the encoder is turned clockwise it counts up, and when turned counter clockwise it counts down. If you choose **Counter Clockwise** the counting direction is reversed.

**Mode** — From the list, choose Single, Double, or Quadruple. This parameter specifies the phase detection mode. That is, how many phase changes are detected. For more information, see the board manual.

**Resolution** — This field specifies the divisions of the connected incremental encoder for one revolution.

**Filter prescale factor** — Enter a base prescale factor for digital filtering. This filter helps eliminate high frequency noise. Enter a value from 0 to ff in hexadecimal (0 to 256 in decimal). For example, for a prescale factor value of ff in hexadecimal, enter

0xff

**Sample time** — Enter a base sample time or a multiple of the base sample time. The sample time indicates the update rate of registration on the input (Duty Cycle). Enter -1 to inherit the model sample time from another block. The sample time is in seconds.

**Base address** — Enter the base address of the board. It is important that this entry corresponds to the DIP switch settings on the board. For example, if the base address is 300 (hexadecimal), enter

0x300

## PC104-DAC06 (/12)

The PC104-DAC06 (12) is an I/O board with 6 analog output (D/A) channels (12-bit).

xPC Target supports this board with this driver block:

- “PC104-DAC06 (/12) Analog Output (D/A)” on page 21-117

### Board Characteristics

|                                 |                   |
|---------------------------------|-------------------|
| Board name                      | PC104-DAC06 (/12) |
| Manufacturer                    | Computer Boards   |
| Bus type                        | ISA (PC104)       |
| Access method                   | I/O mapped        |
| Multiple block instance support | No                |
| Multiple board support          | Yes               |

## PC104-DAC06 (/12) Analog Output (D/A)

### Scaling Input to Output

| Hardware Output | Block Input Data Type | Scaling |
|-----------------|-----------------------|---------|
| volts           | Double                | 1       |

### Driver Block Parameters

**Channel vector** — Enter numbers between 1 and 6. This board allows the selection of individual D/A channels in any order. The number of elements defines the number of D/A channels used. For example, to use the first and second analog output channels, enter

[1,2]

Number the channels beginning with 1 even if the board manufacturer starts numbering the channels with 0.

**Range vector** — Range code for each of the channels in the channel vector. The range vector must be the same length as the channel vector. This board allows the range of each channel to be different.

The following table is a list of the ranges for this driver and the corresponding range codes.

| Input Range (V) | Range Code | Input Range (V) | Range Code |
|-----------------|------------|-----------------|------------|
| -10 to +10      | -10        | 0 - 10          | 10         |
| -5 to +5        | -5         | 0 - 5           | 5          |

For example, if the first channel is -10 to +10 volts, and the second channel is 0 to 5 volts, enter

[ -10,5]

The range settings have to correspond to the jumper settings on the board.

**Reset vector** — The reset vector controls the behavior of the channel at model termination. Enter a scalar or a vector that is the same length as the channel vector. If you specify a scalar value, that setting is used for all channels. If you specify a value of 1, the corresponding channel is reset to the value specified in the initial value vector. If you specify a value of 0, the channel remains at the last value attained while the model was running.

**Initial value vector** — The initial value vector contains the initial voltage values for the output channels. Enter a scalar or a vector that is the same length as the channel vector. If you specify a scalar value, that value is the initial value for all channels. The channels are set to the initial values between the time the model is downloaded and the time it is started.

**Sample time** — Base sample time of a multiple of the base sample time.

**Base address** — Enter the base address of the board. It is important that this entry corresponds to the DIP switch settings on the board. For example, if the base address is 300 (hexadecimal), enter

0x300

The jumpers by the range DIP switches on the board all have to be in the XFER position. The Wait-State jumper has to be in the off position.



## PC104-DAS16JR/12

The PC104-DAS16JR/12 is an I/O board with 16 single or 8 differential analog input channels (12-bit) with a maximum sample rate of 150 kHz, 4 digital input lines and 4 digital output lines.

xPC Target supports this board with these driver blocks:

- “PC104-DAS16JR/12 Analog Input (A/D)” on page 21-119
- “PC104-DAS16JR/12 Digital Input” on page 21-121
- “PC104-DAS16JR/12 Digital Output” on page 21-122

### Board Characteristics

|                                 |                  |
|---------------------------------|------------------|
| Board name                      | PC104-DAS16JR/12 |
| Manufacturer                    | ComputerBoards   |
| Bus type                        | ISA (PC104)      |
| Access method                   | I/O mapped       |
| Multiple block instance support | No               |
| Multiple board support          | Yes              |

### PC104-DAS16JR/12 Analog Input (A/D)

#### Scaling Input to Output

| Hardware Input | Block Output Data Type | Scaling |
|----------------|------------------------|---------|
| volts          | Double                 | 1       |

#### Driver Block Parameters

**Number of Channels** — If you select 16 channels (**Input coupling** parameter set to 16 single-ended channels) enter a number between 1 and 16 to select the number of A/D channels used. If you select eight channels (**Input coupling** parameter set to 8 differential channels) enter a number between 1 and 8. This driver does not allow the selection of individual channels or to mix single-ended and differential inputs.

Number the lines beginning with 1 even if the board manufacturer starts numbering the lines with 0.

**Range** — From the list, choose either +-10V (-10 volts to +10 volts), +-5V, +-2.5V, +-1.25V, +-0.625V, 0-10V, 0-5V, 0-2.5V, or 0-1.25V. This driver does not allow the selection of a different range for each channel.

**Input coupling** — From the list, select one from the following list of input modes:

- Single-ended channels (16 channels)
- Differential channels (8 channels)

This choice must correspond to the MUX-switch setting on the board.

**Sample time** — Enter the base sample time or a multiple of the base sample time.

**Base address** — Enter the base address of the board. It is important that this entry corresponds to the DIP switch settings on the board. For example, if the base address is 300 (hexadecimal), enter

0x300

## PC104-DAS16JR/12 Digital Input

### Scaling Input to Output

| Hardware Input | Block Output Data Type | Scaling                         |
|----------------|------------------------|---------------------------------|
| TTL            | Double                 | TTL low = 0.0<br>TTL high = 1.0 |

### Driver Block Parameters

**Number of Channels** — Enter a number between 1 and 4 to select the number of digital input lines used. This driver does not allow the selection of individual digital input lines.

**Sample time** — Enter the base sample time or a multiple of the base sample time.

**Base address** — Enter the base address of the board. It is important that this entry corresponds to the DIP switch settings on the board. For example, if the base address is 300 (hexadecimal), enter

0x300

## PC104-DAS16JR/12 Digital Output

### Scaling Input to Output

| Hardware Output | Block Input Data Type | Scaling                             |
|-----------------|-----------------------|-------------------------------------|
| TTL             | Double                | < 0.5 = TTL low<br>≥ 0.5 = TTL high |

### Driver Block Parameters

**Number of Channels** — Enter a number between 1 and 4 to select the number of digital output lines used. This driver does not allow the selection of individual digital output lines.

**Sample time** — Enter the base sample time or a multiple of the base sample time.

**Base address** — Enter the base address of the board. It is important that this entry corresponds to the DIP switch settings on the board. For example, if the base address is 300 (hexadecimal), enter

0x300

The switch and jumper settings, that are not mentioned here, have no influence on the running of xPC Target.

## PC104-DAS16JR/16

The PC104-DAS16JR/16 is an I/O board with 16 single or 8 differential analog input (A/D) channels (16-bit) with a maximum sample rate of 100 kHz, 4 digital input lines and 4 digital output lines.

xPC Target supports this board with these driver blocks:

- “PC104-DAS16JR/16 Analog Input (A/D)” on page 21-123
- “PC104-DAS16JR/16 Digital Input” on page 21-125
- “PC104-DAS16JR/16 Digital Output” on page 21-126

### Board Characteristics

|                                 |                  |
|---------------------------------|------------------|
| Board name                      | PC104-DAS16JR/16 |
| Manufacturer                    | ComputerBoards   |
| Bus type                        | ISA (PC104)      |
| Access method                   | I/O mapped       |
| Multiple block instance support | No               |
| Multiple board support          | Yes              |

### PC104-DAS16JR/16 Analog Input (A/D)

#### Scaling Input to Output

| Hardware Input | Block Output Data Type | Scaling |
|----------------|------------------------|---------|
| volts          | Double                 | 1       |

#### Driver Block Parameters

**Number of Channels** — If you select 16 channels (**Input coupling** parameter set to 16 single-ended channels) enter a number between 1 and 16 to select the number of A/D channels used. If you select eight channels (**Input coupling** parameter set to 8 differential channels) enter a number between 1 and 8. This driver does not allow the selection of individual channels or to mix single-ended and differential inputs.

Number the lines beginning with 1 even if the board manufacturer starts numbering the lines with 0.

**Range** — From the list, choose either +-10V (-10 volts to +10 volts), +-5V, +-2.5V, +-1.25V, +-0.625V, 0-10V, 0-5V, 0-2.5V, or 0-1.25V. This driver does not allow the selection of different range for each channel.

**Input coupling** — From the list, select one from the following list of input modes:

- Single-ended channels (16 channels)
- Differential channels (8 channels)

This choice must correspond to the MUX-switch setting on the board.

**Sample time** — Enter the base sample time or a multiple of the base sample time.

**Base address** — Enter the base address of the board. It is important that this entry corresponds to the DIP switch settings on the board. For example, if the base address is 300 (hexadecimal), enter

0x300

## PC104-DAS16JR/16 Digital Input

### Scaling Input to Output

| Hardware Input | Block Output Data Type | Scaling                         |
|----------------|------------------------|---------------------------------|
| TTL            | Double                 | TTL low = 0.0<br>TTL high = 1.0 |

### Driver Block Parameters

**Number of Channels** — Enter a number between 1 and 4 to select the number of digital input lines used. This driver does not allow the selection of individual digital input lines.

**Sample time** — Enter the base sample time or a multiple of the base sample time.

**Base address** — Enter the base address of the board. It is important that this entry corresponds to the DIP switch settings on the board. For example, if the base address is 300 (hexadecimal), enter

0x300

## PC104-DAS16JR/16 Digital Output

### Scaling Input to Output

| Hardware Output | Block Input Data Type | Scaling                             |
|-----------------|-----------------------|-------------------------------------|
| TTL             | Double                | < 0.5 = TTL low<br>≥ 0.5 = TTL high |

### Driver Block Parameters

**Number of Channels** — Enter a number between 1 and 4 to select the number of digital output lines used. This driver does not allow the selection of individual digital output lines.

**Sample time** — Enter the base sample time or a multiple of the base sample time.

**Base address** — Enter the base address of the board. It is important that this entry corresponds to the DIP switch settings on the board. For example, if the base address is 300 (hexadecimal), enter

0x300



## PC104-DIO48

The PC104-DIO48 is an I/O board with 48 digital I/O lines.

xPC Target supports this board with these driver blocks:

- “PC104-DIO48 Digital Input” on page 21-128
- “PC104-DIO48 Digital Output” on page 21-129

### Board Characteristics

|                                 |                |
|---------------------------------|----------------|
| Board name                      | PC104-DIO48    |
| Manufacturer                    | ComputerBoards |
| Bus type                        | ISA (PC104)    |
| Access method                   | I/O mapped     |
| Multiple block instance support | No             |
| Multiple board support          | Yes            |

## PC104-DIO48 Digital Input

The CIO-DIO48 has two 8255 chips (1,2). Each chip has three ports (A,B,C). Each port has a maximum of 8 digital I/O lines that can be configured as inputs or outputs. Use a separate driver block for each port. By selecting the digital input driver block, the port is configured as input.

### Scaling Input to Output

| Hardware Input | Block Output Data Type | Scaling                         |
|----------------|------------------------|---------------------------------|
| TTL            | Double                 | TTL low = 0.0<br>TTL high = 1.0 |

### Driver Block Parameters

**Channel vector** — Enter numbers between 1 and 8 to select the digital input lines used with this port. This driver allows the selection of individual digital input lines in any order. The number of elements defines the number of digital lines used.

For example, to use all of the digital inputs for one port, enter

[ 1,2,3,4,5,6,7,8]

Number the lines beginning with 1 even if the board manufacturer starts numbering the lines with 0.

**Port** — From the list choose either A, B, or C. The I/O board has two 8255 chips with 3 ports. The **Port** parameter defines which port of the 8255 chip is used for this driver block. Each port has a maximum of 8 digital lines that can be configured as inputs or outputs depending on which driver block is chosen. In each case, one block is needed for each port.

**Chip** — From the list choose 1 or 2. The **Chip** parameter defines which of the two 8255 chips is used.

**Sample time** — Enter a base sample time or a multiple of the base sample time.

**Base address** — Enter the base address of the board. This entry must correspond to the DIP switch settings on the board. For example, if the base address is 300 (hexadecimal), enter

0x300

## PC104-DIO48 Digital Output

The PC104-DIO48 has two 8255 chips (1,2). Each chip has three ports (A,B,C). Each port has a maximum of 8 digital I/O lines that can be configured as inputs or outputs. Use a separate driver block for each port. By selecting the digital output driver block, the port is configured as output.

### Scaling Input to Output

| Hardware Output | Block Input Data Type | Scaling                             |
|-----------------|-----------------------|-------------------------------------|
| TTL             | Double                | < 0.5 = TTL low<br>≥ 0.5 = TTL high |

### Driver Block Parameters

**Channel vector** — Enter numbers between 1 and 8 to select the digital output lines used with this port. This driver allows the selection of individual digital output lines in any order. The number of elements defines the number of digital lines used.

For example, to use all of the digital outputs for one port, enter

[1,2,3,4,5,6,7,8]

Number the lines beginning with 1 even if the board manufacturer starts numbering the lines with 0.

**Port** — From the list choose either A, B, or C. The I/O board has two 8255 chips with 3 ports. The **Port** parameter defines which port of the 8255 chip is used for this driver block. Each port has a maximum of 8 digital lines that can be configured as inputs or outputs depending on which driver block is chosen. In each case, one block is needed for each port.

**Reset vector** — The reset vector controls the behavior of the channel at model termination. Enter a scalar or a vector that is the same length as the channel vector. If you specify a scalar value, that setting is used for all channels. If you specify a value of 1, the corresponding channel is reset to the value specified in the initial value vector. If you specify a value of 0, the channel remains at the last value attained while the model was running.

**Initial value vector** — The initial value vector contains the initial values (0 or 1) of the output channels. Enter a scalar or a vector that is the same length as the channel vector. If you enter a scalar, that value is used for all channels. The channels are set to these initial values between the time the model is downloaded and the time it is started.

**Chip** — From the list choose 1 or 2. The **Chip** parameter defines which of the two 8255 chips is used.

**Sample time** — Enter a base sample time or a multiple of the base sample time.

**Base address** — Enter the base address of the board. This entry must correspond to the DIP switch settings on the board. For example, if the base address is 300 (hexadecimal), enter

0x300

## PCI-CTR05

The PCI-CTR05 is an I/O board with 5 counter/timer channels (16-bit).

It contains one AM9513A counter/timer chip. For additional information about the various counter/timer modes of that chip see the AM9513A data sheet which is part of the board documentation.

xPC Target supports this board with these driver blocks:

- “PCI-CTR05 Counter PWM” on page 21-132
- “PCI-CTR05 Counter PWM & ARM” on page 21-133
- “PCI-CTR05 Counter FM” on page 21-135
- “PCI-CTR05 Counter FM & ARM” on page 21-137
- “PCI-CTR05 PWM Capture” on page 21-138
- “PCI-CTR05 Frequency Capture” on page 21-139
- “PCI-CTRxx” on page 21-140

### Board Characteristics

|                                 |                |
|---------------------------------|----------------|
| Board name                      | PCI-CTR05      |
| Manufacturer                    | ComputerBoards |
| Bus type                        | PCI            |
| Access method                   | I/O mapped     |
| Multiple block instance support | Yes            |
| Multiple board support          | Yes            |

## PCI-CTR05 Counter PWM

The PCI-CTR05 PWM driver programs the AM9513A for PWM (Pulse Width Modulation) signal generation (a square wave with fixed frequency and variable duty cycle). The block has one input which defines the variable duty cycle between 0 and 1. For the corresponding counter channel, the PWM signal is output at the pin named OUT.

### Scaling Input to Output

| Hardware Output | Block Input Data Type | Scaling |
|-----------------|-----------------------|---------|
| TTL             | Double                | 0 to 1  |

### Driver Block Parameters

**Counter** — From the list, choose 1, 2, 3, 4, or 5 to select which counter is used with this driver block. In each case, one block is needed for each counter.

**Frequency base** — From the list, choose F1=5MHz, F2=500kHz, F3=50kHz, F4=5kHz, or F5=500Hz to set the base frequency.

**Relative output frequency** — Enter a value between 0 and .25\***Frequency base**. The **Relative output frequency** is multiplied by the **Frequency base** to set the fixed output frequency of the PWM-signal.

For example, if the output frequency of a square wave has to be 17.5 kHz, then choose F2=100kHz as the **Frequency base** and enter 0.175 as the **Relative output frequency**.  $100\text{kHz} \times 0.175 = 17.5 \text{ kHz}$

**Level sequence of square wave** — From the list, choose either high-low or low-high:

- If you choose high-low, the square wave period starts with the TTL high part followed by the TTL low part.
- If you choose low-high, the square wave period starts with the TTL low part followed by the TTL high part.

In either case, the duty cycle entering the block defines the duration of the TTL high part.

**Level when disarmed** — From the list, choose either high or low. The counter is automatically disarmed when the target application is not running and gets armed when the application begins running. This parameter sets the TTL level when the counter is disarmed.

**Sample time** — Enter the base sample time or a multiple of the base sample time. The sample time indicates the update rate of registration on the input (Duty Cycle)

**PCI Slot (-1:autosearch)** — If only one board of this type is physically present in the target PC, enter

-1

to automatically locate the board.

If two or more boards of this type are physically present in the target PC, enter the bus number and the PCI slot number of the board associated with this driver block. Use the format [BusNumber, SlotNumber]. To determine the bus number and the PCI slot number, type

```
getxpcpci
```

## PCI-CTR05 Counter PWM & ARM

The PCI-CTR05 has one AM9513A chip with 5 counters.

The PCI-CTR05 PWM & ARM driver programs the AM9513A for PWM or disarmed signal generation (a square wave with fixed frequency and variable duty cycle). Additionally the driver allows to arm and disarm the counter by the second block input. For the corresponding counter channel, the PWM signal is output at the pin named OUT.

## Scaling Input to Output

| Hardware Output | Block Input Data Type             | Scaling                               |
|-----------------|-----------------------------------|---------------------------------------|
| TTL             | Duty cycle: Double<br>Arm: Double | 0 to 1<br><0.5 disarmed<br>≥0.5 armed |

### Driver Block Parameters

**Counter** — From the list, choose 1, 2, 3, 4, or 5 to select which counter is used with this driver block. In each case, one block is needed for each counter.

**Frequency base** — From the list, choose F1=5MHz, F2=500kHz, F3=50kHz, F4=5kHz, or F5=500Hz to set the base frequency.

**Relative output frequency** — Enter a value between 0 and .25\***Frequency base**. The **Relative output frequency** is multiplied by the **Frequency base** to set the fixed output frequency of the PWM-signal.

For example, if the output frequency of a square wave has to be 17.5 kHz, then choose **F2=100kHz** as the **Frequency base** and enter 0.175 as the **Relative output frequency**.  $100\text{kHz} \times 0.175 = 17.5 \text{ kHz}$

**Level sequence of square wave** — From the list, choose either high-low or low-high:

- If you choose high-low, the square wave period starts with the TTL high part followed by the TTL low part.
- If you choose low-high, the square wave period starts with the TTL low part followed by the TTL high part.

In either case, the duty cycle entering the block defines the duration of the TTL high part.

**Level when disarmed** — From the list, choose either high or low. The counter is automatically disarmed when the target application is not running. If the application is running, the second input port controls whether the counter is armed or disarmed. This parameter sets the TTL level when the counter is disarmed.



**Sample time** — Enter the base sample time or a multiple of the base sample time. The sample time indicates the update rate of registration on the input (Duty Cycle)

**PCI Slot (-1:autosearch)** — If only one board of this type is physically present in the target PC, enter

-1

to automatically locate the board.

If two or more boards of this type are physically present in the target PC, enter the bus number and the PCI slot number of the board associated with this driver block. Use the format [BusNumber, SlotNumber]. To determine the bus number and the PCI slot number, type

```
getxpcpci
```

## PCI-CTR05 Counter FM

The PCI-CTR05 has one AM9513A chip with 5 counters.

The PCI-CTR05 FM driver programs the AM9513A for FM (Frequency Modulation) signal generation (a square wave with fixed duty cycle and variable frequency). For the corresponding counter channel, the PWM signal is output at the pin named OUT.

### Scaling Input to Output

| Hardware Output | Block Input Data Type | Scaling |
|-----------------|-----------------------|---------|
| TTL             | Double                | 0 to 1  |

### Driver Block Parameters

**Counter** — From the list, choose 1, 2, 3, 4, or 5 to select which counter is used with this driver block. In each case, one block is needed for each counter.

**Frequency base** — From the list, choose F1=5MHz, F2=500kHz, F3=50kHz, F4=5kHz, or F5=500Hz to set the base frequency.

**Output duty cycle** — Enter a value between 0 and 1 to set the duty cycle of the square wave. The Duty Cycle is held fixed during execution of the target application.

---

**Note** Your control over the output duty cycle is not always precise. See “PWM and FM Driver Block Notes” on page 1-8 for details.

---

**Level sequence of square wave** — From the list, choose either high-low or low-high:

- If you choose high-low, the square wave period starts with the TTL high part followed by the TTL low part.
- If you choose low-high, the square wave period starts with the TTL low part followed by the TTL high part.

In either case, the duty cycle entering the block defines the duration of the TTL high part.

**Level when disarmed** — From the list, choose either high or low. The counter is automatically disarmed when the target application is not running and gets armed when the application begins running. This parameter sets the TTL level when the counter is disarmed.

**Sample time** — Enter the base sample time or a multiple of the base sample time. The sample time indicates the update rate of registration on the input (Duty Cycle)

**PCI Slot (-1:autosearch)** — If only one board of this type is physically present in the target PC, enter

- 1

to automatically locate the board.

If two or more boards of this type are physically present in the target PC, enter the bus number and the PCI slot number of the board associated with this driver block. Use the format [BusNumber, SlotNumber]. To determine the bus number and the PCI slot number, type

```
getxpcpci
```

## PCI-CTR05 Counter FM & ARM

The PCI-CTR05 has one AM9513A chip with 5 counters.

The PCI-CTR05 FM & ARM driver programs the AM9513A for FM (Frequency Modulation) signal generation (a square wave with fixed duty cycle and variable frequency). Additionally the driver allows to arm and disarm the counter by the second block input. For the corresponding counter channel, the PWM signal is output at the pin named OUT.

### Scaling Input to Output

| Hardware Output | Block Input Data Type                     | Scaling                     |
|-----------------|-------------------------------------------|-----------------------------|
| TTL             | Variable frequency: Double<br>Arm: Double | <0.5 disarmed<br>≥0.5 armed |

### Driver Block Parameters

**Counter** — From the list, choose 1, 2, 3, 4, 5, 6, 7, 8, 9, or 10 to select which counter is used with this driver block. In each case, one block is needed for each counter.

**Frequency base** — From the list, choose F1=5MHz, F2=500kHz, F3=50kHz, F4=5kHz, or F5=500Hz to set the base frequency.

**Output duty cycle** — Enter a value between 0 and 1 to set the duty cycle of the square wave. The Duty Cycle is held fixed during execution of the target application.

---

**Note** Your control over the output duty cycle is not always precise. See “PWM and FM Driver Block Notes” on page 1-8 for details.

---

**Level sequence of square wave** — From the list, choose either high-low or low-high:

- If you choose high-low, the square wave period starts with the TTL high part followed by the TTL low part.
- If you choose low-high, the square wave period starts with the TTL low part followed by the TTL high part.

In either case, the **Output duty cycle** defined in the setting above define the duration of the TTL high part.

**Level when disarmed** — From the list, choose either high or low. The counter is automatically disarmed when the target application is not running. If the application is running, the second input port controls whether the counter is armed or disarmed. This parameter sets the TTL level when the counter is disarmed.

**Sample time** — Enter the base sample time or a multiple of the base sample time. The sample time indicates the update rate of registration on the input (Duty Cycle)

**PCI Slot (-1:autosearch)** — If only one board of this type is physically present in the target PC, enter

- 1

to automatically locate the board.

If two or more boards of this type are physically present in the target PC, enter the bus number and the PCI slot number of the board associated with this driver block. Use the format [BusNumber, SlotNumber]. To determine the bus number and the PCI slot number, type

```
getxpcpci
```

### PCI-CTR05 PWM Capture

This block programs the AMD9513A for capturing PWM signals by using two counters. One counter measures the cycle duration, and the other counter measures the duration the signal is high.

There are two outputs. One output is the relative frequency compared to the base frequency. The other output is the duty cycle. To get the actual frequency, multiply the base frequency by the relative frequency.

The PWM signal has to enter the pins named GATE of both corresponding counter channels (parallel wiring). Both CLK pins have to be left unconnected.

## Scaling Input to Output

| Hardware Output | Block Input Data Type | Scaling |
|-----------------|-----------------------|---------|
| TTL             | Double                | 0 to 1  |

## Driver Block Parameters

**Counter** — From the list, choose 1&2, 2&3, 3&4, 4&5. This selects which two counters the driver block uses to determine the PWM. In each case, one block is needed for each counter.

**Frequency base** — From the list, choose F1=5MHz, F2=500kHz, F3=50kHz, F4=5kHz, or F5=500Hz to set the base frequency.

**Sample time** — Enter the base sample time or a multiple of the base sample time. The sample time indicates the update rate of registration on the input (Duty Cycle)

**PCI Slot (-1:autosearch)** — If only one board of this type is physically present in the target PC, enter

-1

to automatically locate the board.

If two or more boards of this type are physically present in the target PC, enter the bus number and the PCI slot number of the board associated with this driver block. Use the format [BusNumber, SlotNumber]. To determine the bus number and the PCI slot number, type

```
getxpcpci
```

## PCI-CTR05 Frequency Capture

This block programs the AMD9513A for capturing FM signals.

There is one output for relative frequency compared to the base frequency. To get the actual frequency, multiply the base frequency by the relative frequency.

The FM signal has to enter the pin named GATE of the corresponding counter channel. The CLK pin has to be left unconnected.

### Scaling Input to Output

| Hardware Output | Block Input Data Type | Scaling |
|-----------------|-----------------------|---------|
| TTL             | Double                | 0 to 1  |

### Driver Block Parameters

**Counter** — From the list, choose 1, 2, 3, 4 or 5. This selects which counter the driver block uses to determine the FM. In each case, one block is needed for each counter.

**Frequency base** — From the list, choose F1=5MHz, F2=500kHz, F3=50kHz, F4=5kHz, or F5=500Hz to set the base frequency.

**Sample time** — Enter the base sample time or a multiple of the base sample time. The sample time indicates the update rate of registration on the input (Duty Cycle)

**PCI Slot (-1:autosearch)** — If only one board of this type is physically present in the target PC, enter

-1

to automatically locate the board.

If two or more boards of this type are physically present in the target PC, enter the bus number and the PCI slot number of the board associated with this driver block. Use the format [BusNumber, SlotNumber]. To determine the bus number and the PCI slot number, type

```
getxpcpci
```

### PCI-CTRxx

You can use this block to program the AMD9513A counter. The PWM, PWM & ARM, FM, FM & ARM, PWM Capture, and Frequency Capture blocks use this block in their underlying subsystems. The API for this block is not currently documented.

## PCI-DAS1200

The PCI-DAS1200 is an I/O board with 16 single or 8 differential analog input (A/D) channels (12-bit) with a maximum sample rate of 330 kHz, 2 analog output (D/A) channels (12-bit), and 24 digital input and output lines.

xPC Target supports this board with these driver blocks:

- “PCI-DAS1200 Analog Input (A/D)” on page 21-141
- “PCI-DAS1200 Analog Output (D/A)” on page 21-143
- “PCI-DAS1200 Digital Input” on page 21-144
- “PCI-DAS1200 Digital Output” on page 21-146

### Board Characteristics

|                                 |                                     |
|---------------------------------|-------------------------------------|
| Board name                      | PCI-DAS1200                         |
| Manufacturer                    | ComputerBoards                      |
| Bus type                        | PCI                                 |
| Access method                   | I/O mapped                          |
| Multiple block instance support | A/D: No, D/A: Yes, Digital I/O: Yes |
| Multiple board support          | Yes                                 |

## PCI-DAS1200 Analog Input (A/D)

### Scaling Input to Output

| Hardware Input | Block Output Data Type | Scaling |
|----------------|------------------------|---------|
| volts          | Double                 | 1       |

### Driver Block Parameters

**Number of Channels** — If you select 16 channels (**Input coupling** parameter set to 16 single-ended channels) enter a number between 1 and 16 to select the number of A/D channels used. If you select eight channels (**Input coupling** parameter set to 8 differential channels) enter a number between 1 and 8.

This driver does not allow the selection of individual channels or to mix single-ended and differential inputs.

Number the lines beginning with 1 even if the board manufacturer starts numbering the lines with 0.

**Range** — From the list, choose either +-10V (-10 volts to +10 volts), +-5V, +-2.5V, +-1.25V, 0-10V, 0-5V, 0-2.5V, or 0-1.25V. This driver does not allow the selection of different range for each channel.

**Input coupling** — From the list, select one from the following list of input modes:

- Single-ended channels (16 channels)
- Differential channels (8 channels)

This choice must correspond to the MUX-switch setting on the board.

**Sample time** — Enter the base sample time or a multiple of the base sample time.

**PCI Slot (-1:autosearch)** — If only one board of this type is physically present in the target PC, enter

-1

to automatically locate the board.

If two or more boards of this type are physically present in the target PC, enter the bus number and the PCI slot number of the board associated with this driver block. Use the format [BusNumber, SlotNumber]. To determine the bus number and the PCI slot number, type

```
getxpcpci
```



## PCI-DAS1200 Analog Output (D/A)

### Scaling Input to Output

| Hardware Output | Block Input Data Type | Scaling |
|-----------------|-----------------------|---------|
| volts           | Double                | 1       |

### Driver Block Parameters

**Channel vector** — Enter 1 or 2. This driver allows the selection of individual D/A channels in any order. The number of elements defines the number of D/A channels used. For example, to use both of the analog output channels, enter

[1,2]

Number the channels beginning with 1 even if the board manufacturer starts numbering the channels with 0.

**Range vector** — Enter a range code for each of the channels in the channel vector. The range vector must be the same length as the channel vector. This board allows the range of each channel to be different.

The following table is a list of the ranges for this driver and the corresponding range codes.

| Input Range (V) | Range Code | Input Range (V) | Range Code |
|-----------------|------------|-----------------|------------|
| -10 to +10      | -10        | 0 - 10          | 10         |
| -5 to +5        | -5         | 0 - 5           | 5          |

For example, if the first channel is -10 to +10 volts, and the second channel is 0 to 5 volts, enter

[-10,5]

The range settings have to correspond to the DIP switch settings on the board. Also the Bipolar/ Unipolar jumpers have to be placed according to the ranges used.

**Reset vector** — The reset vector controls the behavior of the channel at model termination. Enter a scalar or a vector that is the same length as the channel vector. If you specify a scalar value, that setting is used for all channels. If you specify a value of 1, the corresponding channel is reset to the value specified in the initial value vector. If you specify a value of 0, the channel remains at the last value attained while the model was running.

**Initial value vector** — The initial value vector contains the initial voltage values for the output channels. Enter a scalar or a vector that is the same length as the channel vector. If you specify a scalar value, that value is the initial value for all channels. The channels are set to the initial values between the time the model is downloaded and the time it is started.

**Sample time** — Base sample time of a multiple of the base sample time.

**PCI Slot (-1:autosearch)** — If only one board of this type is physically present in the target PC, enter

-1

to automatically locate the board.

If two or more boards of this type are physically present in the target PC, enter the bus number and the PCI slot number of the board associated with this driver block. Use the format [BusNumber, SlotNumber]. To determine the bus number and the PCI slot number, type

```
getxpcpci
```

## **PCI-DAS1200 Digital Input**

The PCI-DAS1200 has one 8255 chip with 3 ports (A,B,C). Each port has a maximum of 8 digital I/O lines that can be configured as inputs or outputs.

Use a separate driver block for each port. By selecting the digital input driver block, the port is configured as input.

## Scaling Input to Output

| Hardware Input | Block Output Data Type | Scaling                         |
|----------------|------------------------|---------------------------------|
| TTL            | Double                 | TTL low = 0.0<br>TTL high = 1.0 |

### Driver Block Parameters

**Channel vector** — Enter numbers between 1 and 8 to select the digital input lines used with this port. This driver allows the selection of individual digital input lines in any order. The number of elements defines the number of digital lines used.

For example, to use all of the digital inputs for one port, enter

```
[1,2,3,4,5,6,7,8]
```

Number the lines beginning with 1 even if the board manufacturer starts numbering the lines with 0.

**Port** — From the list choose either A, B, or C. The I/O board has a 8255 chip with 3 ports. The **Port** parameter defines which port of the 8255 chip is used for this driver block. Each port has a maximum of 8 digital lines that can be configured as inputs or outputs depending on which driver block is chosen. In each case, one block is needed for each port.

**Sample time** — Enter a base sample time or a multiple of the base sample time.

**PCI Slot (-1:autosearch)** — If only one board of this type is physically present in the target PC, enter

```
-1
```

to automatically locate the board.

If two or more boards of this type are physically present in the target PC, enter the bus number and the PCI slot number of the board associated with this driver block. Use the format [BusNumber, SlotNumber]. To determine the bus number and the PCI slot number, type

```
getxpcpci
```

## PCI-DAS1200 Digital Output

The PCI-DAS1200 has one 8255 chip with 3 ports (A,B,C). Each port has a maximum of 8 digital I/O lines that can be configured as inputs or outputs.

Use a separate driver block for each port. By selecting the digital output driver block, the port is configured as output.

### Scaling Input to Output

| Hardware Output | Block Input Data Type | Scaling                             |
|-----------------|-----------------------|-------------------------------------|
| TTL             | Double                | < 0.5 = TTL low<br>≥ 0.5 = TTL high |

### Driver Block Parameters

**Channel vector** — Enter numbers between 1 and 8 to select the digital output lines used with this port. This driver allows the selection of individual digital output lines in any order. The number of elements defines the number of digital lines used.

For example, to use all of the digital outputs for one port, enter

```
[1,2,3,4,5,6,7,8]
```

Number the lines beginning with 1 even if the board manufacturer starts numbering the lines with 0.

**Port** — From the list choose either A, B, or C. The I/O board has a 8255 chip with 3 ports. The **Port** parameter defines which port of the 8255 chip is used for this driver block. Each port has a maximum of 8 digital lines that can be configured as inputs or outputs depending on which driver block is chosen. In each case, one block is needed for each port.

**Reset vector** — The reset vector controls the behavior of the channel at model termination. Enter a scalar or a vector that is the same length as the channel vector. If you specify a scalar value, that setting is used for all channels. If you specify a value of 1, the corresponding channel is reset to the value specified in the initial value vector. If you specify a value of 0, the channel remains at the last value attained while the model was running.

**Initial value vector** — The initial value vector contains the initial values (0 or 1) of the output channels. Enter a scalar or a vector that is the same length as the channel vector. If you enter a scalar, that value is used for all channels. The channels are set to these initial values between the time the model is downloaded and the time it is started.

**Sample time** — Enter a base sample time or a multiple of the base sample time.

**PCI Slot (-1:autosearch)** — If only one board of this type is physically present in the target PC, enter

-1

to automatically locate the board.

If two or more boards of this type are physically present in the target PC, enter the bus number and the PCI slot number of the board associated with this driver block. Use the format [BusNumber, SlotNumber]. To determine the bus number and the PCI slot number, type

```
getxpcpci
```

## PCI-DAS1200/JR

The PCI-DAS1200/JR is an I/O board with 16 single or 8 differential analog input (A/D) channels (12-bit) with a maximum sample rate of 330 kHz, and 24 digital I/O lines.

xPC Target supports this board with these driver blocks:

- “PCI-DAS1200/JR Analog Input (A/D)” on page 21-148
- “PCI-DAS1200/JR Digital Input” on page 21-149
- “PCI-DAS1200/JR Digital Output” on page 21-151

### Board Characteristics

|                                 |                           |
|---------------------------------|---------------------------|
| Board name                      | PCI-DAS1200/JR            |
| Manufacturer                    | ComputerBoards            |
| Bus type                        | PCI                       |
| Access method                   | I/O mapped                |
| Multiple block instance support | A/D: No, Digital I/O: Yes |
| Multiple board support          | Yes                       |

### PCI-DAS1200/JR Analog Input (A/D)

#### Scaling Input to Output

| Hardware Input | Block Output Data Type | Scaling |
|----------------|------------------------|---------|
| volts          | Double                 | 1       |

#### Driver Block Parameters

**Number of Channels** — If you select 16 channels (**Input coupling** parameter set to 16 single-ended channels) enter a number between 1 and 16 to select the number of A/D channels used. If you select eight channels (**Input coupling** parameter set to 8 differential channels) enter a number between 1 and 8. This driver does not allow the selection of individual channels or to mix single-ended and differential inputs.

Number the lines beginning with 1 even if the board manufacturer starts numbering the lines with 0.

**Range** — From the list, choose either +-10V (-10 volts to +10 volts), +-5V, +-2.5V, +-1.25V, 0-10V, 0-5V, 0-2.5V, or 0-1.25V. This driver does not allow the selection of different range for each channel.

**Input coupling** — From the list, select one from the following list of input modes:

- Single-ended channels (16 channels)
- Differential channels (8 channels)

This choice must correspond to the MUX-switch setting on the board.

**Sample time** — Enter the base sample time or a multiple of the base sample time.

**PCI Slot (-1:autosearch)** — If only one board of this type is physically present in the target PC, enter

-1

to automatically locate the board.

If two or more boards of this type are physically present in the target PC, enter the bus number and the PCI slot number of the board associated with this driver block. Use the format [BusNumber, SlotNumber]. To determine the bus number and the PCI slot number, type

```
getxpcpci
```

## PCI-DAS1200/JR Digital Input

The PCI-DAS1200/JR has one 8255 chip with 3 ports (A,B,C). Each port has a maximum of 8 digital I/O lines that can be configured as inputs or outputs.

Use a separate driver block for each port. By selecting the digital input driver block, the port is configured as input.

## Scaling Input to Output

| Hardware Input | Block Output Data Type | Scaling                         |
|----------------|------------------------|---------------------------------|
| TTL            | Double                 | TTL low = 0.0<br>TTL high = 1.0 |

### Driver Block Parameters

**Channel vector** — Enter numbers between 1 and 8 to select the digital input lines used with this port. This driver allows the selection of individual digital input lines in any order. The number of elements defines the number of digital lines used.

For example, to use all of the digital inputs for one port, enter

```
[1,2,3,4,5,6,7,8]
```

Number the lines beginning with 1 even if the board manufacturer starts numbering the lines with 0.

**Port** — From the list choose either A, B, or C. The I/O board has a 8255 chip with 3 ports. The **Port** parameter defines which port of the 8255 chip is used for this driver block. Each port has a maximum of 8 digital lines that can be configured as inputs or outputs depending on which driver block is chosen. In each case, one block is needed for each port.

**Sample time** — Enter a base sample time or a multiple of the base sample time.

**PCI Slot (-1:autosearch)** — If only one board of this type is physically present in the target PC, enter

```
-1
```

to automatically locate the board.

If two or more boards of this type are physically present in the target PC, enter the bus number and the PCI slot number of the board associated with this driver block. Use the format [BusNumber, SlotNumber]. To determine the bus number and the PCI slot number, type

```
getxpcpci
```



## PCI-DAS1200/JR Digital Output

The PCI-DAS1200 has one 8255 chip with 3 ports (A,B,C). Each port has a maximum of 8 digital I/O lines that can be configured as inputs or outputs.

Use a separate driver block for each port. By selecting the digital output driver block, the port is configured as output.

### Scaling Input to Output

| Hardware Output | Block Input Data Type | Scaling                             |
|-----------------|-----------------------|-------------------------------------|
| TTL             | Double                | < 0.5 = TTL low<br>≥ 0.5 = TTL high |

### Driver Block Parameters

**Channel vector** — Enter numbers between 1 and 8 to select the digital output lines used with this port. This driver allows the selection of individual digital output lines in any order. The number of elements defines the number of digital lines used.

For example, to use all of the digital outputs for one port, enter

```
[1,2,3,4,5,6,7,8]
```

Number the lines beginning with 1 even if the board manufacturer starts numbering the lines with 0.

**Port** — From the list choose either A, B, or C. The I/O board has a 8255 chip with 3 ports. The **Port** parameter defines which port of the 8255 chip is used for this driver block. Each port has a maximum of 8 digital lines that can be configured as inputs or outputs depending on which driver block is chosen. In each case, one block is needed for each port.

**Reset vector** — The reset vector controls the behavior of the channel at model termination. Enter a scalar or a vector that is the same length as the channel vector. If you specify a scalar value, that setting is used for all channels. If you specify a value of 1, the corresponding channel is reset to the value specified in the initial value vector. If you specify a value of 0, the channel remains at the last value attained while the model was running.

**Initial value vector** — The initial value vector contains the initial values (0 or 1) of the output channels. Enter a scalar or a vector that is the same length as the channel vector. If you enter a scalar, that value is used for all channels. The channels are set to these initial values between the time the model is downloaded and the time it is started.

**Sample time** — Enter a base sample time or a multiple of the base sample time.

**PCI Slot (-1:autosearch)** — If only one board of this type is physically present in the target PC, enter

-1

to automatically locate the board.

If two or more boards of this type are physically present in the target PC, enter the bus number and the PCI slot number of the board associated with this driver block. Use the format [BusNumber, SlotNumber]. To determine the bus number and the PCI slot number, type

```
getxpcpci
```

## PCI-DAS1602/12

The PCI-DAS1602/12 is an I/O board with 16 single or 8 differential analog input (A/D) channels (12-bit) with a maximum sampling rate of 200kHz, 2 analog output (D/A) channels (12-bit), and 24 digital input and output lines and 3 counters (16-bit).

xPC Target supports this board with these driver blocks:

- “PCI-DAS1602/12 Analog Input (A/D)” on page 21-153
- “PCI-DAS1602/12 Analog Output (D/A)” on page 21-155
- “PCI-DAS 1602/12 Digital Input” on page 21-156
- “PCI-DAS1602/12 Digital Output” on page 21-158

---

**Note** xPC Target supports only 24 digital I/O lines and does not support the counters on this board.

---

### Board Characteristics

|                                 |                |
|---------------------------------|----------------|
| Board Name                      | PCI-DAS1602/12 |
| Manufacturer                    | ComputerBoards |
| Bus type                        | ISA            |
| Access method                   | I/O mapped     |
| Multiple block instance support | Yes            |
| Multiple board support          | Yes            |

### PCI-DAS1602/12 Analog Input (A/D)

#### Scaling of Input to Output

| Hardware Input | Block Output Data Type | Scaling |
|----------------|------------------------|---------|
| volts          | Double                 | 1       |

### Driver Block Parameters

**Number of channels** — If you select 16 channels (**Input coupling** parameter set to 16 single-ended channels) enter a number between 1 and 16 to select the number of A/D channels used. If you select eight channels (**Input coupling** parameter set to 8 differential channels) enter a number between 1 and 8. This driver does not allow the selection of individual channels or to mix single-ended and differential inputs.

Number the lines beginning with 1 even if the board manufacturer starts numbering the lines with 0.

**Range** — From the list, choose either +-10V (-10 volts to +10 volts), +-5V, +-2.5V, +-1.25V, +-0.625V, 0-10V, 0-5V, 0-2.5V, or 0-1.25V. This driver does not allow the selection of a different range for each channel.

If a bipolar range is used, the bipolar switch on the board must be in the bipolar position. If a unipolar range is used, the bipolar switch must be in the unipolar position.

**Input coupling** — From the list, select one from the following list of input modes:

- Single-ended channels (16 channels)
- Differential channels (8 channels)

This choice must correspond to the MUX-switch setting on the board.

**Sample time** — Enter the base sample time or a multiple of the base sample time.

**PCI Slot (-1:autosearch)** — If only one board of this type is physically present in the target PC, enter

-1

to automatically locate the board.

If two or more boards of this type are physically present in the target PC, enter the bus number and the PCI slot number of the board associated with this driver block. Use the format [BusNumber, SlotNumber]. To determine the bus number and the PCI slot number, type

```
getxpcpci
```

## PCI-DAS1602/12 Analog Output (D/A)

### Scaling of Input to Output

| Hardware Output | Block Input Data Type | Scaling |
|-----------------|-----------------------|---------|
| volts           | Double                | 1       |

### Driver Block Parameters

**Channel vector** — Enter 1 or 2. This driver allows the selection of individual D/A channels in any order. The number of elements defines the number of D/A channels used. For example, to use the first and second analog output (D/A) channels, enter

[ 1,2]

Number channels begin with 1 even if the board manufacturer starts numbering channels with 0.

**Range vector** — Enter a range code for each of the channels in the channel vector. The range vector must be the same length as the channel vector. This board allows the range of each channel to be different.

The following table is a list of the ranges for this driver and the corresponding range codes.

| Input Range (V) | Range Code | Input Range (V) | Range Code |
|-----------------|------------|-----------------|------------|
| -10 to +10      | -10        | 0 - 10          | 10         |
| -5 to +5        | -5         | 0 - 5           | 5          |

For example, if the first channel is -10 to +10 volts, and the second channel is 0 to 5 volts, enter

[ -10,5]

**Reset vector** — The reset vector controls the behavior of the channel at model termination. Enter a scalar or a vector that is the same length as the channel vector. If you specify a scalar value, that setting is used for all channels. If you specify a value of 1, the corresponding channel is reset to the value specified in

the initial value vector. If you specify a value of 0, the channel remains at the last value attained while the model was running.

**Initial value vector** — The initial value vector contains the initial voltage values for the output channels. Enter a scalar or a vector that is the same length as the channel vector. If you specify a scalar value, that value is the initial value for all channels. The channels are set to the initial values between the time the model is downloaded and the time it is started.

**Sample time** — Base sample time of a multiple of the base sample time.

**PCI Slot (-1:autosearch)** — If only one board of this type is physically present in the target PC, enter

-1

to automatically locate the board.

If two or more boards of this type are physically present in the target PC, enter the bus number and the PCI slot number of the board associated with this driver block. Use the format [BusNumber, SlotNumber]. To determine the bus number and the PCI slot number, type

```
getxpcpci
```

## **PCI-DAS 1602/12 Digital Input**

The DAS1601/12 has a 8255 chip with 3 ports (A,B,C). Each port has a maximum of 8 digital I/O lines that can be configured as inputs or outputs.

Use a separate driver block for each port. By selecting the digital input driver block, the port is configured as input.

## Scaling of Input to Output

| Hardware Input | Block Output Data Type | Scaling                         |
|----------------|------------------------|---------------------------------|
| TTL            | Double                 | TTL low = 0.0<br>TTL high = 1.0 |

### Driver Block Parameters

**Channel vector** — Enter numbers between 1 and 8 to select the digital input lines used with this port. This driver allows the selection of individual digital input lines in any order. The number of elements defines the number of digital lines used.

For example, to use all of the digital inputs for one port, enter

```
[1,2,3,4,5,6,7,8]
```

Number the lines beginning with 1 even if the board manufacturer starts numbering the lines with 0.

**Port** — From the list choose either A, B, or C. The I/O board has a 8255 chip with 3 ports. The port name defines which port of the 8255 chip is used for this driver block. Each port has a maximum of 8 digital lines that can be configured as inputs or outputs depending on which driver block is chosen. In each case, one block is needed for each port.

**Sample time** — Enter a base sample time or a multiple of the base sample time.

**PCI Slot (-1:autosearch)** — If only one board of this type is physically present in the target PC, enter

```
-1
```

to automatically locate the board.

If two or more boards of this type are physically present in the target PC, enter the bus number and the PCI slot number of the board associated with this driver block. Use the format [BusNumber, SlotNumber]. To determine the bus number and the PCI slot number, type

```
getxpcpci
```

## PCI-DAS1602/12 Digital Output

The DAS1601/12 has a 8255 chip with 3 ports (A,B,C). Each port has a maximum of 8 digital I/O lines that can be configured as inputs or outputs.

Use a separate driver block for each port. By selecting the digital output driver block, the port is configured as output.

### Scaling of Input to Output

| Hardware Output | Block Input Data Type | Scaling                             |
|-----------------|-----------------------|-------------------------------------|
| TTL             | Double                | < 0.5 = TTL low<br>≥ 0.5 = TTL high |

### Driver Block Parameters

**Channel vector** — Enter numbers between 1 and 8 to select the digital output lines used with this port. This driver allows the selection of individual digital output lines in any order. The number of elements defines the number of digital lines used.

For example, to use all of the digital outputs for one port, enter

[1,2,3,4,5,6,7,8]

Number the lines beginning with 1 even if the board manufacturer starts numbering the lines with 0.

**Port** — From the list choose either A, B, or C. The I/O board has a 8255 chip with 3 ports. The port name defines which port of the 8255 chip is used for this driver block. Each port has a maximum of 8 digital lines that can be configured as inputs or outputs depending on which driver block is chosen. In each case, one block is needed for each port.

**Reset vector** — The reset vector controls the behavior of the channel at model termination. Enter a scalar or a vector that is the same length as the channel vector. If you specify a scalar value, that setting is used for all channels. If you specify a value of 1, the corresponding channel is reset to the value specified in the initial value vector. If you specify a value of 0, the channel remains at the last value attained while the model was running.



**Initial value vector** — The initial value vector contains the initial values (0 or 1) of the output channels. Enter a scalar or a vector that is the same length as the channel vector. If you enter a scalar, that value is used for all channels. The channels are set to these initial values between the time the model is downloaded and the time it is started.

**Sample time** — Enter a base sample time or a multiple of the base sample time.

**PCI Slot (-1:autosearch)** — If only one board of this type is physically present in the target PC, enter

-1

to automatically locate the board.

If two or more boards of this type are physically present in the target PC, enter the bus number and the PCI slot number of the board associated with this driver block. Use the format [BusNumber, SlotNumber]. To determine the bus number and the PCI slot number, type

```
getxpcpci
```

## PCI-DAS1602/16

The PCI-DAS1602/16 is an I/O board with 16 single or 8 differential analog input (A/D) channels (16-bit) with a maximum sampling rate of 200kHz, 2 analog output (D/A) channels (16-bit), and 24 digital input and output lines and 3 counters (16-bit).

xPC Target supports this board with these driver blocks:

- “PCI-DAS1602/16 Analog Input (A/D)” on page 21-161
- “PCI-DAS1602/16 Analog Output (D/A)” on page 21-162
- “PCI-DAS 1602/16 Digital Input” on page 21-163
- “PCI-DAS1602/16 Digital Output” on page 21-165

---

**Note** xPC Target supports only 24 digital I/O lines and does not support the counters on this board.

---

### Board Characteristics

|                                 |                |
|---------------------------------|----------------|
| Board Name                      | PCI-DAS1602/16 |
| Manufacturer                    | ComputerBoards |
| Bus type                        | ISA            |
| Access method                   | I/O mapped     |
| Multiple block instance support | Yes            |
| Multiple board support          | Yes            |

## PCI-DAS1602/16 Analog Input (A/D)

### Scaling of Input to Output

| Hardware Input | Block Output Data Type | Scaling |
|----------------|------------------------|---------|
| volts          | Double                 | 1       |

### Driver Block Parameters

**Number of channels** — If you select 16 channels (**Input coupling** parameter set to 16 single-ended channels) enter a number between 1 and 16 to select the number of A/D channels used. If you select eight channels (**Input coupling** parameter set to 8 differential channels) enter a number between 1 and 8. This driver does not allow the selection of individual channels or to mix single-ended and differential inputs.

Number the lines beginning with 1 even if the board manufacturer starts numbering the lines with 0.

**Range** — From the list, choose either + -10V (-10 volts to +10 volts), + -5V, + -2.5V, + -1.25V, + -0.625V, 0-10V, 0-5V, 0-2.5V, or 0-1.25V. This driver does not allow the selection of a different range for each channel.

If a bipolar range is used, the bipolar switch on the board must be in the bipolar position. If a unipolar range is used, the bipolar switch must be in the unipolar position.

**Input coupling** — From the list, select one from the following list of input modes:

- Single-ended channels (16 channels)
- Differential channels (8 channels)

This choice must correspond to the MUX-switch setting on the board.

**Sample time** — Enter the base sample time or a multiple of the base sample time.

**PCI Slot (-1:autosearch)** — If only one board of this type is physically present in the target PC, enter

- 1

to automatically locate the board.

If two or more boards of this type are physically present in the target PC, enter the bus number and the PCI slot number of the board associated with this driver block. Use the format [BusNumber, SlotNumber]. To determine the bus number and the PCI slot number, type

```
getxpcpci
```

## PCI-DAS1602/16 Analog Output (D/A)

### Scaling of Input to Output

| Hardware Output | Block Input Data Type | Scaling |
|-----------------|-----------------------|---------|
| volts           | Double                | 1       |

### Driver Block Parameters

**Channel vector** — Enter numbers 1 or 2. This driver allows the selection of individual D/A channels in any order. The number of elements defines the number of D/A channels used. For example, to use the first and second analog output (D/A) channels, enter

```
[1,2]
```

Number channels begin with 1 even if the board manufacturer starts numbering channels with 0.

**Range vector** — Enter a vector or range codes to specify the ranges of each of the channels. This must be a vector of the same length as the channel vector. Otherwise, a scalar is assumed to apply to each channel.

The following table is a list of the ranges for this driver and the corresponding range codes.

| Input Range (V) | Range Code | Input Range (V) | Range Code |
|-----------------|------------|-----------------|------------|
| -10 to +10      | -10        | 0 - 10          | 10         |
| -5 to +5        | -5         | 0 - 5           | 5          |

For example, if the first channel is -10 to +10 volts, and the second channel is 0 to 5 volts, enter

```
[ -10,5]
```

The range settings have to correspond to the DIP switch settings on the board. Also the Bipolar/ Unipolar jumpers have to be planted according to the ranges used.

**Reset vector** — The reset vector controls the behavior of the channel at model termination. Enter a scalar or a vector that is the same length as the channel vector. If you specify a scalar value, that setting is used for all channels. If you specify a value of 1, the corresponding channel is reset to the value specified in the initial value vector. If you specify a value of 0, the channel remains at the last value attained while the model was running.

**Initial value vector** — The initial value vector contains the initial voltage values for the output channels. Enter a scalar or a vector that is the same length as the channel vector. If you specify a scalar value, that value is the initial value for all channels. The channels are set to the initial values between the time the model is downloaded and the time it is started.

**Sample time** — Base sample time of a multiple of the base sample time.

**PCI Slot (-1:autosearch)** — If only one board of this type is physically present in the target PC, enter

```
-1
```

to automatically locate the board.

If two or more boards of this type are physically present in the target PC, enter the bus number and the PCI slot number of the board associated with this driver block. Use the format [BusNumber, SlotNumber]. To determine the bus number and the PCI slot number, type

```
getxpcpci
```

## PCI-DAS 1602/16 Digital Input

The DAS1601/16 has a 8255 chip with 3 ports (A,B,C). Each port has a maximum of 8 digital I/O lines that can be configured as inputs or outputs.

Use a separate driver block for each port. By selecting the digital input driver block, the port is configured as input.

## Scaling of Input to Output

| Hardware Input | Block Output Data Type | Scaling                         |
|----------------|------------------------|---------------------------------|
| TTL            | Double                 | TTL low = 0.0<br>TTL high = 1.0 |

### Driver Block Parameters

**Channel vector** — Enter numbers between 1 and 8 to select the digital input lines used with this port. This driver allows the selection of individual digital input lines in any order. The number of elements defines the number of digital lines used.

For example, to use all of the digital inputs for one port, enter

```
[1,2,3,4,5,6,7,8]
```

Number the lines beginning with 1 even if the board manufacturer starts numbering the lines with 0.

**Port** — From the list choose either A, B, or C. The I/O board has a 8255 chip with 3 ports. The port name defines which port of the 8255 chip is used for this driver block. Each port has a maximum of 8 digital lines that can be configured as inputs or outputs depending on which driver block is chosen. In each case, one block is needed for each port.

**Sample time** — Enter a base sample time or a multiple of the base sample time.

**PCI Slot (-1:autosearch)** — If only one board of this type is physically present in the target PC, enter

```
-1
```

to automatically locate the board.

If two or more boards of this type are physically present in the target PC, enter the bus number and the PCI slot number of the board associated with this driver block. Use the format [BusNumber, SlotNumber]. To determine the bus number and the PCI slot number, type

```
getxpcpci
```

## PCI-DAS1602/16 Digital Output

The DAS1601/16 has a 8255 chip with 3 ports (A,B,C). Each port has a maximum of 8 digital I/O lines that can be configured as inputs or outputs.

Use a separate driver block for each port. By selecting the digital output driver block, the port is configured as output.

### Scaling of Input to Output

| Hardware Output | Block Input Data Type | Scaling                             |
|-----------------|-----------------------|-------------------------------------|
| TTL             | Double                | < 0.5 = TTL low<br>≥ 0.5 = TTL high |

### Driver Block Parameters

**Channel vector** — Enter numbers between 1 and 8 to select the digital output lines used with this port. This driver allows the selection of individual digital output lines in any order. The number of elements defines the number of digital lines used.

For example, to use all of the digital outputs for one port, enter

```
[1,2,3,4,5,6,7,8]
```

Number the lines beginning with 1 even if the board manufacturer starts numbering the lines with 0.

**Port** — From the list choose either A, B, or C. The I/O board has a 8255 chip with 3 ports. The port name defines which port of the 8255 chip is used for this driver block. Each port has a maximum of 8 digital lines that can be configured as inputs or outputs depending on which driver block is chosen. In each case, one block is needed for each port.

**Reset vector** — The reset vector controls the behavior of the channel at model termination. Enter a scalar or a vector that is the same length as the channel vector. If you specify a scalar value, that setting is used for all channels. If you specify a value of 1, the corresponding channel is reset to the value specified in the initial value vector. If you specify a value of 0, the channel remains at the last value attained while the model was running.

**Initial value vector** — The initial value vector contains the initial values (0 or 1) of the output channels. Enter a scalar or a vector that is the same length as the channel vector. If you enter a scalar, that value is used for all channels. The channels are set to these initial values between the time the model is downloaded and the time it is started.

**Sample time** — Enter a base sample time or a multiple of the base sample time.

**PCI Slot (-1:autosearch)** — If only one board of this type is physically present in the target PC, enter

-1

to automatically locate the board.

If two or more boards of this type are physically present in the target PC, enter the bus number and the PCI slot number of the board associated with this driver block. Use the format [BusNumber, SlotNumber]. To determine the bus number and the PCI slot number, type

```
getxpcpci
```



## PCI-DDA02/12

The PCI-DDA02/12 is an I/O board with 2 analog output (D/A) channels (12-bit), and 48 digital I/O lines.

xPC Target supports this board with these driver blocks:

- “PCI-DDA02/12 Analog Output (D/A)” on page 21-167
- “PCI-DDA02/12 Digital Input” on page 21-169
- “PCI-DDA02/12 Digital Output” on page 21-170

### Board Characteristics

|                                 |                 |
|---------------------------------|-----------------|
| Board name                      | PCI-DDA02/12    |
| Manufacturer                    | Computer Boards |
| Bus type                        | PCI             |
| Access method                   | I/O mapped      |
| Multiple block instance support | Yes             |
| Multiple board support          | Yes             |

### PCI-DDA02/12 Analog Output (D/A)

#### Scaling Input to Output

| Hardware Output | Block Input Data Type | Scaling |
|-----------------|-----------------------|---------|
| volts           | Double                | 1       |

### Driver Block Parameters

**Channel vector** — Enter numbers 1 or 2. This driver allows the selection of individual D/A channels in any order. The number of elements defines the number of D/A channels used. For example, to use both of the analog output channels, enter

[1,2]

Number the channels beginning with 1 even if the board manufacturer starts numbering the channels with 0.

**Range vector** — Enter a range code for each of the channels in the channel vector. The range vector must be the same length as the channel vector. This board allows the range of each channel to be different.

The following table is a list of the ranges for this driver and the corresponding range codes.

| Input Range (V) | Range Code | Input Range (V) | Range Code |
|-----------------|------------|-----------------|------------|
| -10 to +10      | -10        | 0 - +10         | 10         |
| -5 to +5        | -5         | 0 - +5          | 5          |
| -2.5 to +2.5    | -2.5       | 0 - +2.5        | 2.5        |

For example, if the first channel is -10 to +10 volts, and the second channel is 0 to 5 volts, enter

[ -10,5]

The range settings have to correspond to the DIP switch settings on the board. Also the Bipolar/ Unipolar jumpers have to be placed according to the ranges used.

**Reset vector** — The reset vector controls the behavior of the channel at model termination. Enter a scalar or a vector that is the same length as the channel vector. If you specify a scalar value, that setting is used for all channels. If you specify a value of 1, the corresponding channel is reset to the value specified in the initial value vector. If you specify a value of 0, the channel remains at the last value attained while the model was running.

**Initial value vector** — The initial value vector contains the initial voltage values for the output channels. Enter a scalar or a vector that is the same length as the channel vector. If you specify a scalar value, that value is the initial value for all channels. The channels are set to the initial values between the time the model is downloaded and the time it is started.

**Sample time** — Base sample time of a multiple of the base sample time.

**PCI Slot (-1:autosearch)** — If only one board of this type is physically present in the target PC, enter

-1

to automatically locate the board.

If two or more boards of this type are physically present in the target PC, enter the bus number and the PCI slot number of the board associated with this driver block. Use the format [BusNumber, SlotNumber]. To determine the bus number and the PCI slot number, type

```
getxpcpci
```

## PCI-DDA02/12 Digital Input

The PCI-DDA02/12 has two 8255 chips (1,2). Each chip has three ports (A,B,C). Each port has a maximum of 8 digital I/O lines that can be configured as inputs or outputs.

Use a separate driver block for each port. By selecting the digital input driver block, the port is configured as input.

### Scaling Input to Output

| Hardware Input | Block Output Data Type | Scaling                         |
|----------------|------------------------|---------------------------------|
| TTL            | Double                 | TTL low = 0.0<br>TTL high = 1.0 |

### Driver Block Parameters

**Channel vector** — Enter numbers between 1 and 8 to select the digital input lines used with this port. This driver allows the selection of individual digital input lines in any order. The number of elements defines the number of digital lines used.

For example, to use all of the digital inputs for one port, enter

```
[1,2,3,4,5,6,7,8]
```

Number the lines beginning with 1 even if the board manufacturer starts numbering the lines with 0.

**Port** — From the list choose either A, B, or C. The I/O board has two 8255 chips with 3 ports. The **Port** parameter defines which port of the 8255 chip is used for this driver block. Each port has a maximum of 8 digital lines that can be configured as inputs or outputs depending on which driver block is chosen. In each case, one block is needed for each port.

**Chip** — From the list choose 1 or 2. The **Chip** parameter defines which of the two 8255 chips is used.

**Sample time** — Enter a base sample time or a multiple of the base sample time.

**PCI Slot (-1:autosearch)** — If only one board of this type is physically present in the target PC, enter

- 1

to automatically locate the board.

If two or more boards of this type are physically present in the target PC, enter the bus number and the PCI slot number of the board associated with this driver block. Use the format [BusNumber, SlotNumber]. To determine the bus number and the PCI slot number, type

```
getxpcpci
```

## **PCI-DDA02/12 Digital Output**

The PCI-DDA02/12 has two 8255 chips (1,2). Each chip has three ports (A,B,C). Each port has a maximum of 8 digital I/O lines that can be configured as inputs or outputs.

Use a separate driver block for each port. By selecting the digital output driver block, the port is configured as output.

## Scaling Input to Output

| Hardware Output | Block Input Data Type | Scaling                             |
|-----------------|-----------------------|-------------------------------------|
| TTL             | Double                | < 0.5 = TTL low<br>≥ 0.5 = TTL high |

## Driver Block Parameters

**Channel vector** — Enter numbers between 1 and 8 to select the digital output lines used with this port. This driver allows the selection of individual digital output lines in any order. The number of elements defines the number of digital lines used.

For example, to use all of the digital outputs for one port, enter

```
[1,2,3,4,5,6,7,8]
```

Number the lines beginning with 1 even if the board manufacturer starts numbering the lines with 0.

**Port** — From the list choose either A, B, or C. The I/O board has two 8255 chips with 3 ports. The **Port** parameter defines which port of the 8255 chip is used for this driver block. Each port has a maximum of 8 digital lines that can be configured as inputs or outputs depending on which driver block is chosen. In each case, one block is needed for each port.

**Reset vector** — The reset vector controls the behavior of the channel at model termination. Enter a scalar or a vector that is the same length as the channel vector. If you specify a scalar value, that setting is used for all channels. If you specify a value of 1, the corresponding channel is reset to the value specified in the initial value vector. If you specify a value of 0, the channel remains at the last value attained while the model was running.

**Initial value vector** — The initial value vector contains the initial values (0 or 1) of the output channels. Enter a scalar or a vector that is the same length as the channel vector. If you enter a scalar, that value is used for all channels. The channels are set to these initial values between the time the model is downloaded and the time it is started.

**Chip** — From the list choose 1 or 2. The **Chip** parameter defines which of the two 8255 chips is used.

**Sample time** — Enter a base sample time or a multiple of the base sample time.

**PCI Slot (-1:autosearch)** — If only one board of this type is physically present in the target PC, enter

-1

to automatically locate the board.

If two or more boards of this type are physically present in the target PC, enter the bus number and the PCI slot number of the board associated with this driver block. Use the format [BusNumber, SlotNumber]. To determine the bus number and the PCI slot number, type

```
getxpcpci
```

## PCI-DDA02/16

The PCI-DDA02/16 is an I/O board with 2 analog output (D/A) channels (12-bit), and 48 digital I/O lines.

xPC Target supports this board with these driver blocks:

- “PCI-DDA02/16 Analog Output (D/A)” on page 21-173
- “PCI-DDA02/16 Digital Input” on page 21-175
- “PCI-DDA02/16 Digital Output” on page 21-176

### Board Characteristics

|                                 |                 |
|---------------------------------|-----------------|
| Board name                      | PCI-DDA06/12    |
| Manufacturer                    | Computer Boards |
| Bus type                        | PCI             |
| Access method                   | I/O mapped      |
| Multiple block instance support | Yes             |
| Multiple board support          | Yes             |

### PCI-DDA02/16 Analog Output (D/A)

#### Scaling Input to Output

| Hardware Output | Block Input Data Type | Scaling |
|-----------------|-----------------------|---------|
| volts           | Double                | 1       |

#### Driver Block Parameters

**Channel vector** — Enter 1 or 2. This driver allows the selection of individual D/A channels in any order. The number of elements defines the number of D/A channels used. For example, to use both of the analog output channels, enter

[1,2]

Number the channels beginning with 1 even if the board manufacturer starts numbering the channels with 0.

**Range vector** — Enter a range code for each of the channels in the channel vector. The range vector must be the same length as the channel vector. This board allows the range of each channel to be different.

The following table is a list of the ranges for this driver and the corresponding range codes.

| Input Range (V) | Range Code | Input Range (V) | Range Code |
|-----------------|------------|-----------------|------------|
| -10 to +10      | -10        | 0 - +10         | 10         |
| -5 to +5        | -5         | 0 - +5          | 5          |
| -2.5 to +2.5    | -2.5       | 0 - +2.5        | 2.5        |

For example, if the first channel is -10 to +10 volts, and the second channel is 0 to 5 volts, enter

[ -10,5]

The range settings have to correspond to the DIP switch settings on the board. Also the Bipolar/ Unipolar jumpers have to be placed according to the ranges used.

**Reset vector** — The reset vector controls the behavior of the channel at model termination. Enter a scalar or a vector that is the same length as the channel vector. If you specify a scalar value, that setting is used for all channels. If you specify a value of 1, the corresponding channel is reset to the value specified in the initial value vector. If you specify a value of 0, the channel remains at the last value attained while the model was running.

**Initial value vector** — The initial value vector contains the initial voltage values for the output channels. Enter a scalar or a vector that is the same length as the channel vector. If you specify a scalar value, that value is the initial value for all channels. The channels are set to the initial values between the time the model is downloaded and the time it is started.

**Sample time** — Base sample time of a multiple of the base sample time.



**PCI Slot (-1:autosearch)** — If only one board of this type is physically present in the target PC, enter

-1

to automatically locate the board.

If two or more boards of this type are physically present in the target PC, enter the bus number and the PCI slot number of the board associated with this driver block. Use the format [BusNumber, SlotNumber]. To determine the bus number and the PCI slot number, type

```
getxpcpci
```

## PCI-DDA02/16 Digital Input

The PCI-DDA02/16 has two 8255 chips (1,2). Each chip has three ports (A,B,C). Each port has a maximum of 8 digital I/O lines that can be configured as inputs or outputs.

Use a separate driver block for each port. By selecting the digital input driver block, the port is configured as input.

### Scaling Input to Output

| Hardware Input | Block Output Data Type | Scaling                         |
|----------------|------------------------|---------------------------------|
| TTL            | Double                 | TTL low = 0.0<br>TTL high = 1.0 |

### Driver Block Parameters

**Channel vector** — Enter numbers between 1 and 8 to select the digital input lines used with this port. This driver allows the selection of individual digital input lines in any order. The number of elements defines the number of digital lines used.

For example, to use all of the digital inputs for one port, enter

```
[1,2,3,4,5,6,7,8]
```

Number the lines beginning with 1 even if the board manufacturer starts numbering the lines with 0.

**Port** — From the list choose either A, B, or C. The I/O board has two 8255 chips with 3 ports. The **Port** parameter defines which port of the 8255 chip is used for this driver block. Each port has a maximum of 8 digital lines that can be configured as inputs or outputs depending on which driver block is chosen. In each case, one block is needed for each port.

**Chip** — From the list choose 1 or 2. The **Chip** parameter defines which of the two 8255 chips is used.

**Sample time** — Enter a base sample time or a multiple of the base sample time.

**PCI Slot (-1:autosearch)** — If only one board of this type is physically present in the target PC, enter

- 1

to automatically locate the board.

If two or more boards of this type are physically present in the target PC, enter the bus number and the PCI slot number of the board associated with this driver block. Use the format [BusNumber, SlotNumber]. To determine the bus number and the PCI slot number, type

```
getxpcpci
```

## **PCI-DDA02/16 Digital Output**

The PCI-DDA02/16 has two 8255 chips (1,2). Each chip has three ports (A,B,C). Each port has a maximum of 8 digital I/O lines that can be configured as inputs or outputs.

Use a separate driver block for each port. By selecting the digital output driver block, the port is configured as output.

## Scaling Input to Output

| Hardware Output | Block Input Data Type | Scaling                             |
|-----------------|-----------------------|-------------------------------------|
| TTL             | Double                | < 0.5 = TTL low<br>≥ 0.5 = TTL high |

## Driver Block Parameters

**Channel vector** — Enter numbers between 1 and 8 to select the digital output lines used with this port. This driver allows the selection of individual digital output lines in any order. The number of elements defines the number of digital lines used.

For example, to use all of the digital outputs for one port, enter

```
[1,2,3,4,5,6,7,8]
```

Number the lines beginning with 1 even if the board manufacturer starts numbering the lines with 0.

**Port** — From the list choose either A, B, or C. The I/O board has two 8255 chips with 3 ports. The **Port** parameter defines which port of the 8255 chip is used for this driver block. Each port has a maximum of 8 digital lines that can be configured as inputs or outputs depending on which driver block is chosen. In each case, one block is needed for each port.

**Reset vector** — The reset vector controls the behavior of the channel at model termination. Enter a scalar or a vector that is the same length as the channel vector. If you specify a scalar value, that setting is used for all channels. If you specify a value of 1, the corresponding channel is reset to the value specified in the initial value vector. If you specify a value of 0, the channel remains at the last value attained while the model was running.

**Initial value vector** — The initial value vector contains the initial values (0 or 1) of the output channels. Enter a scalar or a vector that is the same length as the channel vector. If you enter a scalar, that value is used for all channels. The channels are set to these initial values between the time the model is downloaded and the time it is started.

**Chip** — From the list choose 1 or 2. The **Chip** parameter defines which of the two 8255 chips is used.

**Sample time** — Enter a base sample time or a multiple of the base sample time.

**PCI Slot (-1:autosearch)** — If only one board of this type is physically present in the target PC, enter

-1

to automatically locate the board.

If two or more boards of this type are physically present in the target PC, enter the bus number and the PCI slot number of the board associated with this driver block. Use the format [BusNumber, SlotNumber]. To determine the bus number and the PCI slot number, type

```
getxpcpci
```

## PCI-DDA04/12

The PCI-DDA04/12 is an I/O board with 4 analog output (D/A) channels (12-bit), and 48 digital I/O lines.

xPC Target supports this board with these driver blocks:

- “PCI-DDA04/12 Analog Output (D/A)” on page 21-179
- “PCI-DDA04/12 Digital Input” on page 21-181
- “PCI-DDA04/12 Digital Output” on page 21-182

### Board Characteristics

|                                 |                 |
|---------------------------------|-----------------|
| Board name                      | PCI-DDA04/12    |
| Manufacturer                    | Computer Boards |
| Bus type                        | PCI             |
| Access method                   | I/O mapped      |
| Multiple block instance support | Yes             |
| Multiple board support          | Yes             |

### PCI-DDA04/12 Analog Output (D/A)

#### Scaling Input to Output

| Hardware Output | Block Input Data Type | Scaling |
|-----------------|-----------------------|---------|
| volts           | Double                | 1       |

### Driver Block Parameters

**Channel vector** — Enter numbers between 1 and 4. This driver allows the selection of individual D/A channels in any order. The number of elements defines the number of D/A channels used. For example, to use the first and second analog output channels, enter

[1,2]

Number the channels beginning with 1 even if the board manufacturer starts numbering the channels with 0.

**Range vector** — Enter a range code for each of the channels in the channel vector. The range vector must be the same length as the channel vector. This board allows the range of each channel to be different.

The following table is a list of the ranges for this driver and the corresponding range codes.

| Input Range (V) | Range Code | Input Range (V) | Range Code |
|-----------------|------------|-----------------|------------|
| -10 to +10      | -10        | 0 - +10         | 10         |
| -5 to +5        | -5         | 0 - +5          | 5          |
| -2.5 to +2.5    | -2.5       | 0 - +2.5        | 2.5        |

For example, if the first channel is -10 to +10 volts, and the second channel is 0 to 5 volts, enter

[ -10,5]

The range settings have to correspond to the DIP switch settings on the board. Also the Bipolar/ Unipolar jumpers have to be placed according to the ranges used.

**Reset vector** — The reset vector controls the behavior of the channel at model termination. Enter a scalar or a vector that is the same length as the channel vector. If you specify a scalar value, that setting is used for all channels. If you specify a value of 1, the corresponding channel is reset to the value specified in the initial value vector. If you specify a value of 0, the channel remains at the last value attained while the model was running.

**Initial value vector** — The initial value vector contains the initial voltage values for the output channels. Enter a scalar or a vector that is the same length as the channel vector. If you specify a scalar value, that value is the initial value for all channels. The channels are set to the initial values between the time the model is downloaded and the time it is started.

**Sample time** — Base sample time of a multiple of the base sample time.

**PCI Slot (-1:autosearch)** — If only one board of this type is physically present in the target PC, enter

-1

to automatically locate the board.

If two or more boards of this type are physically present in the target PC, enter the bus number and the PCI slot number of the board associated with this driver block. Use the format [BusNumber, SlotNumber]. To determine the bus number and the PCI slot number, type

```
getxpcpci
```

## PCI-DDA04/12 Digital Input

The PCI-DDA4/12 has two 8255 chips (1,2). Each chip has three ports (A,B,C). Each port has a maximum of 8 digital I/O lines that can be configured as inputs or outputs.

Use a separate driver block for each port. By selecting the digital input driver block, the port is configured as input.

### Scaling Input to Output

| Hardware Input | Block Output Data Type | Scaling                         |
|----------------|------------------------|---------------------------------|
| TTL            | Double                 | TTL low = 0.0<br>TTL high = 1.0 |

### Driver Block Parameters

**Channel vector** — Enter numbers between 1 and 8 to select the digital input lines used with this port. This driver allows the selection of individual digital input lines in any order. The number of elements defines the number of digital lines used.

For example, to use all of the digital inputs for one port, enter

```
[1,2,3,4,5,6,7,8]
```

Number the lines beginning with 1 even if the board manufacturer starts numbering the lines with 0.

**Port** — From the list choose either A, B, or C. The I/O board has two 8255 chips with 3 ports. The **Port** parameter defines which port of the 8255 chip is used for this driver block. Each port has a maximum of 8 digital lines that can be configured as inputs or outputs depending on which driver block is chosen. In each case, one block is needed for each port.

**Chip** — From the list choose 1 or 2. The **Chip** parameter defines which of the two 8255 chips is used.

**Sample time** — Enter a base sample time or a multiple of the base sample time.

**PCI Slot (-1:autosearch)** — If only one board of this type is physically present in the target PC, enter

- 1

to automatically locate the board.

If two or more boards of this type are physically present in the target PC, enter the bus number and the PCI slot number of the board associated with this driver block. Use the format [BusNumber, SlotNumber]. To determine the bus number and the PCI slot number, type

```
getxpcpci
```

## **PCI-DDA04/12 Digital Output**

The PCI-DDA04/12 has two 8255 chips (1,2). Each chip has three ports (A,B,C). Each port has a maximum of 8 digital I/O lines that can be configured as inputs or outputs.

Use a separate driver block for each port. By selecting the digital output driver block, the port is configured as output.



## Scaling Input to Output

| Hardware Output | Block Input Data Type | Scaling                             |
|-----------------|-----------------------|-------------------------------------|
| TTL             | Double                | < 0.5 = TTL low<br>≥ 0.5 = TTL high |

## Driver Block Parameters

**Channel vector** — Enter numbers between 1 and 8 to select the digital output lines used with this port. This driver allows the selection of individual digital output lines in any order. The number of elements defines the number of digital lines used.

For example, to use all of the digital outputs for one port, enter

```
[1,2,3,4,5,6,7,8]
```

Number the lines beginning with 1 even if the board manufacturer starts numbering the lines with 0.

**Port** — From the list choose either A, B, or C. The I/O board has two 8255 chips with 3 ports. The **Port** parameter defines which port of the 8255 chip is used for this driver block. Each port has a maximum of 8 digital lines that can be configured as inputs or outputs depending on which driver block is chosen. In each case, one block is needed for each port.

**Reset vector** — The reset vector controls the behavior of the channel at model termination. Enter a scalar or a vector that is the same length as the channel vector. If you specify a scalar value, that setting is used for all channels. If you specify a value of 1, the corresponding channel is reset to the value specified in the initial value vector. If you specify a value of 0, the channel remains at the last value attained while the model was running.

**Initial value vector** — The initial value vector contains the initial values (0 or 1) of the output channels. Enter a scalar or a vector that is the same length as the channel vector. If you enter a scalar, that value is used for all channels. The channels are set to these initial values between the time the model is downloaded and the time it is started.

**Chip** — From the list choose 1 or 2. The **Chip** parameter defines which of the two 8255 chips is used.

**Sample time** — Enter a base sample time or a multiple of the base sample time.

**PCI Slot (-1:autosearch)** — If only one board of this type is physically present in the target PC, enter

-1

to automatically locate the board.

If two or more boards of this type are physically present in the target PC, enter the bus number and the PCI slot number of the board associated with this driver block. Use the format [BusNumber, SlotNumber]. To determine the bus number and the PCI slot number, type

```
getxpcpci
```

## PCI-DDA04/16

The PCI-DDA04/16 is an I/O board with 4 analog output (D/A) channels (16-bit), and 48 digital I/O lines.

xPC Target supports this board with these driver blocks:

- “PCI-DDA04/16 Analog Output (D/A)” on page 21-185
- “PCI-DDA04/16 Digital Input” on page 21-187
- “PCI-DDA04/16 Digital Output” on page 21-188

### Board Characteristics

|                                 |                 |
|---------------------------------|-----------------|
| Board name                      | PCI-DDA04/16    |
| Manufacturer                    | Computer Boards |
| Bus type                        | PCI             |
| Access method                   | I/O mapped      |
| Multiple block instance support | Yes             |
| Multiple board support          | Yes             |

### PCI-DDA04/16 Analog Output (D/A)

#### Scaling Input to Output

| Hardware Output | Block Input Data Type | Scaling |
|-----------------|-----------------------|---------|
| volts           | Double                | 1       |

### Driver Block Parameters

**Channel vector** — Enter numbers between 1 and 4. This driver allows the selection of individual D/A channels in any order. The number of elements defines the number of D/A channels used. For example, to use the first and second analog output channels, enter

[1,2]

Number the channels beginning with 1 even if the board manufacturer starts numbering the channels with 0.

**Range vector** — Enter a range code for each of the channels in the channel vector. The range vector must be the same length as the channel vector. This board allows the range of each channel to be different.

The following table is a list of the ranges for this driver and the corresponding range codes.

| Input Range (V) | Range Code | Input Range (V) | Range Code |
|-----------------|------------|-----------------|------------|
| -10 to +10      | -10        | 0 - +10         | 10         |
| -5 to +5        | -5         | 0 - +5          | 5          |
| -2.5 to +2.5    | -2.5       | 0 - +2.5        | 2.5        |

For example, if the first channel is -10 to +10 volts, and the second channel is 0 to 5 volts, enter

[ -10,5]

The range settings have to correspond to the DIP switch settings on the board. Also the Bipolar/ Unipolar jumpers have to be placed according to the ranges used.

**Reset vector** — The reset vector controls the behavior of the channel at model termination. Enter a scalar or a vector that is the same length as the channel vector. If you specify a scalar value, that setting is used for all channels. If you specify a value of 1, the corresponding channel is reset to the value specified in the initial value vector. If you specify a value of 0, the channel remains at the last value attained while the model was running.

**Initial value vector** — The initial value vector contains the initial voltage values for the output channels. Enter a scalar or a vector that is the same length as the channel vector. If you specify a scalar value, that value is the initial value for all channels. The channels are set to the initial values between the time the model is downloaded and the time it is started.

**Sample time** — Base sample time of a multiple of the base sample time.

**PCI Slot (-1:autosearch)** — If only one board of this type is physically present in the target PC, enter

-1

to automatically locate the board.

If two or more boards of this type are physically present in the target PC, enter the bus number and the PCI slot number of the board associated with this driver block. Use the format [BusNumber, SlotNumber]. To determine the bus number and the PCI slot number, type

```
getxpcpci
```

## PCI-DDA04/16 Digital Input

The PCI-DDA4/16 has two 8255 chips (1,2). Each chip has three ports (A,B,C). Each port has a maximum of 8 digital I/O lines that can be configured as inputs or outputs.

Use a separate driver block for each port. By selecting the digital input driver block, the port is configured as input.

### Scaling Input to Output

| Hardware Input | Block Output Data Type | Scaling                         |
|----------------|------------------------|---------------------------------|
| TTL            | Double                 | TTL low = 0.0<br>TTL high = 1.0 |

### Driver Block Parameters

**Channel vector** — Enter numbers between 1 and 8 to select the digital input lines used with this port. This driver allows the selection of individual digital input lines in any order. The number of elements defines the number of digital lines used.

For example, to use all of the digital inputs for one port, enter

```
[1,2,3,4,5,6,7,8]
```

Number the lines beginning with 1 even if the board manufacturer starts numbering the lines with 0.

**Port** — From the list choose either A, B, or C. The I/O board has two 8255 chips with 3 ports. The **Port** parameter defines which port of the 8255 chip is used for this driver block. Each port has a maximum of 8 digital lines that can be configured as inputs or outputs depending on which driver block is chosen. In each case, one block is needed for each port.

**Chip** — From the list choose 1 or 2. The **Chip** parameter defines which of the two 8255 chips is used.

**Sample time** — Enter a base sample time or a multiple of the base sample time.

**PCI Slot (-1:autosearch)** — If only one board of this type is physically present in the target PC, enter

- 1

to automatically locate the board.

If two or more boards of this type are physically present in the target PC, enter the bus number and the PCI slot number of the board associated with this driver block. Use the format [BusNumber, SlotNumber]. To determine the bus number and the PCI slot number, type

```
getxpcpci
```

## **PCI-DDA04/16 Digital Output**

The PCI-DDA04/16 has two 8255 chips (1,2). Each chip has three ports (A,B,C). Each port has a maximum of 8 digital I/O lines that can be configured as inputs or outputs.

Use a separate driver block for each port. By selecting the digital output driver block, the port is configured as output.

## Scaling Input to Output

| Hardware Output | Block Input Data Type | Scaling                             |
|-----------------|-----------------------|-------------------------------------|
| TTL             | Double                | < 0.5 = TTL low<br>≥ 0.5 = TTL high |

## Driver Block Parameters

**Channel vector** — Enter numbers between 1 and 8 to select the digital output lines used with this port. This driver allows the selection of individual digital output lines in any order. The number of elements defines the number of digital lines used.

For example, to use all of the digital outputs for one port, enter

```
[1,2,3,4,5,6,7,8]
```

Number the lines beginning with 1 even if the board manufacturer starts numbering the lines with 0.

**Port** — From the list choose either A, B, or C. The I/O board has two 8255 chips with 3 ports. The **Port** parameter defines which port of the 8255 chip is used for this driver block. Each port has a maximum of 8 digital lines that can be configured as inputs or outputs depending on which driver block is chosen. In each case, one block is needed for each port.

**Reset vector** — The reset vector controls the behavior of the channel at model termination. Enter a scalar or a vector that is the same length as the channel vector. If you specify a scalar value, that setting is used for all channels. If you specify a value of 1, the corresponding channel is reset to the value specified in the initial value vector. If you specify a value of 0, the channel remains at the last value attained while the model was running.

**Initial value vector** — The initial value vector contains the initial values (0 or 1) of the output channels. Enter a scalar or a vector that is the same length as the channel vector. If you enter a scalar, that value is used for all channels. The channels are set to these initial values between the time the model is downloaded and the time it is started.

**Chip** — From the list choose 1 or 2. The **Chip** parameter defines which of the two 8255 chips is used.

**Sample time** — Enter a base sample time or a multiple of the base sample time.

**PCI Slot (-1:autosearch)** — If only one board of this type is physically present in the target PC, enter

-1

to automatically locate the board.

If two or more boards of this type are physically present in the target PC, enter the bus number and the PCI slot number of the board associated with this driver block. Use the format [BusNumber, SlotNumber]. To determine the bus number and the PCI slot number, type

```
getxpcpci
```



## PCI-DDA08/12

The PCI-DDA08/12 is an I/O board with 8 analog output (A/D) channels (16-bit), and 48 digital I/O lines.

xPC Target supports this board with these driver blocks:

- “PCI-DDA08/12 Analog Output (D/A)” on page 21-191
- “PCI-DDA08/12 Digital Input” on page 21-193
- “PCI-DDA08/12 Digital Output” on page 21-194

### Board Characteristics

|                                 |                |
|---------------------------------|----------------|
| Board name                      | PCI-DDA08/12   |
| Manufacturer                    | ComputerBoards |
| Bus type                        | PCI            |
| Access method                   | I/O mapped     |
| Multiple block instance support | Yes            |
| Multiple board support          | Yes            |

### PCI-DDA08/12 Analog Output (D/A)

#### Scaling Input to Output

| Hardware Output | Block Input Data Type | Scaling |
|-----------------|-----------------------|---------|
| volts           | Double                | 1       |

### Driver Block Parameters

**Channel vector** — Enter numbers between 1 and 8. This driver allows the selection of individual D/A channels in any order. The number of elements defines the number of D/A channels used. For example, to use the first and second analog output channels, enter

[1,2]

Number the channels beginning with 1 even if the board manufacturer starts numbering the channels with 0.

**Range vector** — Enter a range code for each of the channels in the channel vector. The range vector must be the same length as the channel vector. This board allows the range of each channel to be different.

The following table is a list of the ranges for this driver and the corresponding range codes

| Input Range (V) | Range Code | Input Range (V) | Range Code |
|-----------------|------------|-----------------|------------|
| -10 to +10      | -10        | 0 - +10         | 10         |
| -5 to +5        | -5         | 0 - +5          | 5          |
| -2.5 to +2.5    | -2.5       | 0 - +2.5        | 2.5        |

For example, if the first channel is -10 to +10 volts, and the second channel is 0 to 5 volts, enter

[ -10,5]

The range settings have to correspond to the DIP switch settings on the board. Also the Bipolar/ Unipolar jumpers have to be placed according to the ranges used.

**Reset vector** — The reset vector controls the behavior of the channel at model termination. Enter a scalar or a vector that is the same length as the channel vector. If you specify a scalar value, that setting is used for all channels. If you specify a value of 1, the corresponding channel is reset to the value specified in the initial value vector. If you specify a value of 0, the channel remains at the last value attained while the model was running.

**Initial value vector** — The initial value vector contains the initial voltage values for the output channels. Enter a scalar or a vector that is the same length as the channel vector. If you specify a scalar value, that value is the initial value for all channels. The channels are set to the initial values between the time the model is downloaded and the time it is started.

**Sample time** — Base sample time of a multiple of the base sample time.

**PCI Slot (-1:autosearch)** — If only one board of this type is physically present in the target PC, enter

-1

to automatically locate the board.

If two or more boards of this type are physically present in the target PC, enter the bus number and the PCI slot number of the board associated with this driver block. Use the format [BusNumber, SlotNumber]. To determine the bus number and the PCI slot number, type

```
getxpcpci
```

## PCI-DDA08/12 Digital Input

The PCI-DDA08/12 has two 8255 chips (1,2). Each chip has three ports (A,B,C). Each port has a maximum of 8 digital I/O lines that can be configured as inputs or outputs.

Use a separate driver block for each port. By selecting the digital input driver block, the port is configured as input.

### Scaling Input to Output

| Hardware Input | Block Output Data Type | Scaling                         |
|----------------|------------------------|---------------------------------|
| TTL            | Double                 | TTL low = 0.0<br>TTL high = 1.0 |

### Driver Block Parameters

**Channel vector** — Enter numbers between 1 and 8 to select the digital input lines used with this port. This driver allows the selection of individual digital input lines in any order. The number of elements defines the number of digital lines used.

For example, to use all of the digital inputs for one port, enter

```
[1,2,3,4,5,6,7,8]
```

Number the lines beginning with 1 even if the board manufacturer starts numbering the lines with 0.

**Port** — From the list choose either A, B, or C. The I/O board has two 8255 chips with 3 ports. The **Port** parameter defines which port of the 8255 chip is used for this driver block. Each port has a maximum of 8 digital lines that can be configured as inputs or outputs depending on which driver block is chosen. In each case, one block is needed for each port.

**Chip** — From the list choose 1 or 2. The **Chip** parameter defines which of the two 8255 chips is used.

**Sample time** — Enter a base sample time or a multiple of the base sample time.

**PCI Slot (-1:autosearch)** — If only one board of this type is physically present in the target PC, enter

- 1

to automatically locate the board.

If two or more boards of this type are physically present in the target PC, enter the bus number and the PCI slot number of the board associated with this driver block. Use the format [BusNumber, SlotNumber]. To determine the bus number and the PCI slot number, type

```
getxpcpci
```

## **PCI-DDA08/12 Digital Output**

The PCI-DDA08/12 has two 8255 chips (1,2). Each chip has three ports (A,B,C). Each port has a maximum of 8 digital I/O lines that can be configured as inputs or outputs.

Use a separate driver block for each port. By selecting the digital output driver block, the port is configured as output.

## Scaling Input to Output

| Hardware Output | Block Input Data Type | Scaling                             |
|-----------------|-----------------------|-------------------------------------|
| TTL             | Double                | < 0.5 = TTL low<br>≥ 0.5 = TTL high |

## Driver Block Parameters

**Channel vector** — Enter numbers between 1 and 8 to select the digital output lines used with this port. This driver allows the selection of individual digital output lines in any order. The number of elements defines the number of digital lines used.

For example, to use all of the digital outputs for one port, enter

```
[1,2,3,4,5,6,7,8]
```

Number the lines beginning with 1 even if the board manufacturer starts numbering the lines with 0.

**Port** — From the list choose either A, B, or C. The I/O board has two 8255 chips with 3 ports. The **Port** parameter defines which port of the 8255 chip is used for this driver block. Each port has a maximum of 8 digital lines that can be configured as inputs or outputs depending on which driver block is chosen. In each case, one block is needed for each port.

**Reset vector** — The reset vector controls the behavior of the channel at model termination. Enter a scalar or a vector that is the same length as the channel vector. If you specify a scalar value, that setting is used for all channels. If you specify a value of 1, the corresponding channel is reset to the value specified in the initial value vector. If you specify a value of 0, the channel remains at the last value attained while the model was running.

**Initial value vector** — The initial value vector contains the initial values (0 or 1) of the output channels. Enter a scalar or a vector that is the same length as the channel vector. If you enter a scalar, that value is used for all channels. The channels are set to these initial values between the time the model is downloaded and the time it is started.

**Chip** — From the list choose 1 or 2. The **Chip** parameter defines which of the two 8255 chips is used.

**Sample time** — Enter a base sample time or a multiple of the base sample time.

**PCI Slot (-1:autosearch)** — If only one board of this type is physically present in the target PC, enter

-1

to automatically locate the board.

If two or more boards of this type are physically present in the target PC, enter the bus number and the PCI slot number of the board associated with this driver block. Use the format [BusNumber, SlotNumber]. To determine the bus number and the PCI slot number, type

```
getxpcpci
```

## PCI-DDA08/16

The PCI-DDA08/16 is an I/O board with 8 analog output (A/D) channels (12-bit), and 48 digital I/O lines.

xPC Target supports this board with these driver blocks:

- “PCI-DDA08/16 Analog Output (D/A)” on page 21-197
- “PCI-DDA08/16 Digital Input” on page 21-199
- “PCI-DDA08/16 Digital Output” on page 21-200

### Board Characteristics

|                                 |                |
|---------------------------------|----------------|
| Board name                      | PCI-DDA06/12   |
| Manufacturer                    | ComputerBoards |
| Bus type                        | PCI            |
| Access method                   | I/O mapped     |
| Multiple block instance support | Yes            |
| Multiple board support          | Yes            |

### PCI-DDA08/16 Analog Output (D/A)

#### Scaling Input to Output

| Hardware Output | Block Input Data Type | Scaling |
|-----------------|-----------------------|---------|
| volts           | Double                | 1       |

### Driver Block Parameters

**Channel vector** — Enter numbers between 1 and 8. This driver allows the selection of individual D/A channels in any order. The number of elements defines the number of D/A channels used. For example, to use the first and second analog output channels, enter

[1,2]

Number the channels beginning with 1 even if the board manufacturer starts numbering the channels with 0.

**Range vector** — Enter a range code for each of the channels in the channel vector. The range vector must be the same length as the channel vector. This board allows the range of each channel to be different.

The following table is a list of the ranges for this driver and the corresponding range codes

| Input Range (V) | Range Code | Input Range (V) | Range Code |
|-----------------|------------|-----------------|------------|
| -10 to +10      | -10        | 0 - +10         | 10         |
| -5 to +5        | -5         | 0 - +5          | 5          |
| -2.5 to +2.5    | -2.5       | 0 - +2.5        | 2.5        |

For example, if the first channel is -10 to +10 volts, and the second channel is 0 to 5 volts, enter

[ -10,5]

The range settings have to correspond to the DIP switch settings on the board. Also the Bipolar/ Unipolar jumpers have to be placed according to the ranges used.

**Reset vector** — The reset vector controls the behavior of the channel at model termination. Enter a scalar or a vector that is the same length as the channel vector. If you specify a scalar value, that setting is used for all channels. If you specify a value of 1, the corresponding channel is reset to the value specified in the initial value vector. If you specify a value of 0, the channel remains at the last value attained while the model was running.

**Initial value vector** — The initial value vector contains the initial voltage values for the output channels. Enter a scalar or a vector that is the same length as the channel vector. If you specify a scalar value, that value is the initial value for all channels. The channels are set to the initial values between the time the model is downloaded and the time it is started.

**Sample time** — Base sample time of a multiple of the base sample time.



**PCI Slot (-1:autosearch)** — If only one board of this type is physically present in the target PC, enter

-1

to automatically locate the board.

If two or more boards of this type are physically present in the target PC, enter the bus number and the PCI slot number of the board associated with this driver block. Use the format [BusNumber, SlotNumber]. To determine the bus number and the PCI slot number, type

```
getxpcpci
```

## PCI-DDA08/16 Digital Input

The PCI-DDA08/16 has two 8255 chips (1,2). Each chip has three ports (A,B,C). Each port has a maximum of 8 digital I/O lines that can be configured as inputs or outputs.

Use a separate driver block for each port. By selecting the digital input driver block, the port is configured as input.

### Scaling Input to Output

| Hardware Input | Block Output Data Type | Scaling                         |
|----------------|------------------------|---------------------------------|
| TTL            | Double                 | TTL low = 0.0<br>TTL high = 1.0 |

### Driver Block Parameters

**Channel vector** — Enter numbers between 1 and 8 to select the digital input lines used with this port. This driver allows the selection of individual digital input lines in any order. The number of elements defines the number of digital lines used.

For example, to use all of the digital inputs for one port, enter

```
[1,2,3,4,5,6,7,8]
```

Number the lines beginning with 1 even if the board manufacturer starts numbering the lines with 0.

**Port** — From the list choose either A, B, or C. The I/O board has two 8255 chips with 3 ports. The **Port** parameter defines which port of the 8255 chip is used for this driver block. Each port has a maximum of 8 digital lines that can be configured as inputs or outputs depending on which driver block is chosen. In each case, one block is needed for each port.

**Chip** — From the list choose 1 or 2. The **Chip** parameter defines which of the two 8255 chips is used.

**Sample time** — Enter a base sample time or a multiple of the base sample time.

**PCI Slot (-1:autosearch)** — If only one board of this type is physically present in the target PC, enter

- 1

to automatically locate the board.

If two or more boards of this type are physically present in the target PC, enter the bus number and the PCI slot number of the board associated with this driver block. Use the format [BusNumber, SlotNumber]. To determine the bus number and the PCI slot number, type

```
getxpcpci
```

## **PCI-DDA08/16 Digital Output**

The PCI-DDA08/16 has two 8255 chips (1,2). Each chip has three ports (A,B,C). Each port has a maximum of 8 digital I/O lines that can be configured as inputs or outputs.

Use a separate driver block for each port. By selecting the digital output driver block, the port is configured as output.

## Scaling Input to Output

| Hardware Output | Block Input Data Type | Scaling                             |
|-----------------|-----------------------|-------------------------------------|
| TTL             | Double                | < 0.5 = TTL low<br>≥ 0.5 = TTL high |

## Driver Block Parameters

**Channel vector** — Enter numbers between 1 and 8 to select the digital output lines used with this port. This driver allows the selection of individual digital output lines in any order. The number of elements defines the number of digital lines used.

For example, to use all of the digital outputs for one port, enter

```
[1,2,3,4,5,6,7,8]
```

Number the lines beginning with 1 even if the board manufacturer starts numbering the lines with 0.

**Port** — From the list choose either A, B, or C. The I/O board has two 8255 chips with 3 ports. The **Port** parameter defines which port of the 8255 chip is used for this driver block. Each port has a maximum of 8 digital lines that can be configured as inputs or outputs depending on which driver block is chosen. In each case, one block is needed for each port.

**Reset vector** — The reset vector controls the behavior of the channel at model termination. Enter a scalar or a vector that is the same length as the channel vector. If you specify a scalar value, that setting is used for all channels. If you specify a value of 1, the corresponding channel is reset to the value specified in the initial value vector. If you specify a value of 0, the channel remains at the last value attained while the model was running.

**Initial value vector** — The initial value vector contains the initial values (0 or 1) of the output channels. Enter a scalar or a vector that is the same length as the channel vector. If you enter a scalar, that value is used for all channels. The channels are set to these initial values between the time the model is downloaded and the time it is started.

**Chip** — From the list choose 1 or 2. The **Chip** parameter defines which of the two 8255 chips is used.

**Sample time** — Enter a base sample time or a multiple of the base sample time.

**PCI Slot (-1:autosearch)** — If only one board of this type is physically present in the target PC, enter

-1

to automatically locate the board.

If two or more boards of this type are physically present in the target PC, enter the bus number and the PCI slot number of the board associated with this driver block. Use the format [BusNumber, SlotNumber]. To determine the bus number and the PCI slot number, type

```
getxpcpci
```

## PCI-DIO24

The PCI-DIO24 is an I/O board with 24 digital I/O lines.

xPC Target supports this board with these driver blocks:

- “PCI-DIO24 Digital Input” on page 21-203
- “PCI-DIO24 Digital Output” on page 21-204
- “PCI-DIO24 Signal Conditioning” on page 21-206

### Board Characteristics

|                                 |                |
|---------------------------------|----------------|
| Board name                      | PCI-DIO24      |
| Manufacturer                    | ComputerBoards |
| Bus type                        | PCI            |
| Access method                   | I/O mapped     |
| Multiple block instance support | Yes            |
| Multiple board support          | Yes            |

### PCI-DIO24 Digital Input

The PCI-DIO24 has one 8255 chip with 3 ports (A,B,C). Each port has a maximum of 8 digital I/O lines that can be configured as inputs or outputs.

Use a separate driver block for each port. By selecting the digital input driver block, the port is configured as input.

### Scaling Input to Output

| Hardware Input | Block Output Data Type | Scaling                         |
|----------------|------------------------|---------------------------------|
| TTL            | Double                 | TTL low = 0.0<br>TTL high = 1.0 |

### Driver Block Parameters

**Channel vector** — Enter numbers between 1 and 8 to select the digital input lines used with this port. This driver allows the selection of individual digital input lines in any order. The number of elements defines the number of digital lines used.

For example, to use all of the digital inputs for one port, enter

```
[ 1, 2, 3, 4, 5, 6, 7, 8 ]
```

Number the lines beginning with 1 even if the board manufacturer starts numbering the lines with 0.

**Port** — From the list choose either A, B, or C. The I/O board has a 8255 chip with 3 ports. The **Port** parameter defines which port of the 8255 chip is used for this driver block. Each port has a maximum of 8 digital lines that can be configured as inputs or outputs depending on which driver block is chosen. In each case, one block is needed for each port.

**Sample time** — Enter a base sample time or a multiple of the base sample time.

**PCI Slot (-1:autosearch)** — If only one board of this type is physically present in the target PC, enter

```
- 1
```

to automatically locate the board.

If two or more boards of this type are physically present in the target PC, enter the bus number and the PCI slot number of the board associated with this driver block. Use the format [BusNumber, SlotNumber]. To determine the bus number and the PCI slot number, type

```
getxpcpci
```

### PCI-DIO24 Digital Output

The PCI-DIO24 has one 8255 chip with 3 ports (A,B,C). Each port has a maximum of 8 digital I/O lines that can be configured as inputs or outputs.

Use a separate driver block for each port. By selecting the digital output driver block, the port is configured as output.

## Scaling Input to Output

| Hardware Output | Block Input Data Type | Scaling                             |
|-----------------|-----------------------|-------------------------------------|
| TTL             | Double                | < 0.5 = TTL low<br>≥ 0.5 = TTL high |

### Driver Block Parameters

**Channel vector** — Enter numbers between 1 and 8 to select the digital output lines used with this port. This driver allows the selection of individual digital output lines in any order. The number of elements defines the number of digital lines used.

For example, to use all of the digital outputs for one port, enter

```
[1,2,3,4,5,6,7,8]
```

Number the lines beginning with 1 even if the board manufacturer starts numbering the lines with 0.

**Port** — From the list choose either A, B, or C. The I/O board has a 8255 chip with 3 ports. The **Port** parameter defines which port of the 8255 chip is used for this driver block. Each port has a maximum of 8 digital lines that can be configured as inputs or outputs depending on which driver block is chosen. In each case, one block is needed for each port.

**Reset vector** — The reset vector controls the behavior of the channel at model termination. Enter a scalar or a vector that is the same length as the channel vector. If you specify a scalar value, that setting is used for all channels. If you specify a value of 1, the corresponding channel is reset to the value specified in the initial value vector. If you specify a value of 0, the channel remains at the last value attained while the model was running.

**Initial value vector** — The initial value vector contains the initial values (0 or 1) of the output channels. Enter a scalar or a vector that is the same length as the channel vector. If you enter a scalar, that value is used for all channels. The channels are set to these initial values between the time the model is downloaded and the time it is started.

**Sample time** — Enter a base sample time or a multiple of the base sample time.

**PCI Slot (-1:autosearch)** — If only one board of this type is physically present in the target PC, enter

-1

to automatically locate the board.

If two or more boards of this type are physically present in the target PC, enter the bus number and the PCI slot number of the board associated with this driver block. Use the format [BusNumber, SlotNumber]. To determine the bus number and the PCI slot number, type

```
getxpcpci
```

## **PCI-DIO24 Signal Conditioning**

**Genix initialization file (path\file)** — Provide the filename of the Genix initialization file.

**PCI Slot (-1:autosearch)** — If only one board of this type is physically present in the target PC, enter

-1

to automatically locate the board.

If two or more boards of this type are physically present in the target PC, enter the bus number and the PCI slot number of the board associated with this driver block. Use the format [BusNumber, SlotNumber]. To determine the bus number and the PCI slot number, type

```
getxpcpci
```



## PCI-DIO24H

The PCI-DIO24H is an I/O board with 24 digital I/O lines.

xPC Target supports this board with these driver blocks:

- “PCI-DIO24H Digital Input” on page 21-207
- “PCI-DIO24H Digital Output” on page 21-208

### Board Characteristics

|                                 |                |
|---------------------------------|----------------|
| Board name                      | PCI-DIO24H     |
| Manufacturer                    | ComputerBoards |
| Bus type                        | PCI            |
| Access method                   | I/O mapped     |
| Multiple block instance support | Yes            |
| Multiple board support          | Yes            |

### PCI-DIO24H Digital Input

The PCI-DIO24H has one 8255 chip with 3 ports (A,B,C). Each port has a maximum of 8 digital I/O lines that can be configured as inputs or outputs.

Use a separate driver block for each port. By selecting the digital input driver block, the port is configured as input.

### Scaling Input to Output

| Hardware Input | Block Output Data Type | Scaling                         |
|----------------|------------------------|---------------------------------|
| TTL            | Double                 | TTL low = 0.0<br>TTL high = 1.0 |

### Driver Block Parameters

**Channel vector** — Enter numbers between 1 and 8 to select the digital input lines used with this port. This driver allows the selection of individual digital input lines in any order. The number of elements defines the number of digital lines used.

For example, to use all of the digital inputs for one port, enter

```
[ 1, 2, 3, 4, 5, 6, 7, 8 ]
```

Number the lines beginning with 1 even if the board manufacturer starts numbering the lines with 0.

**Port** — From the list choose either A, B, or C. The I/O board has a 8255 chip with 3 ports. The **Port** parameter defines which port of the 8255 chip is used for this driver block. Each port has a maximum of 8 digital lines that can be configured as inputs or outputs depending on which driver block is chosen. In each case, one block is needed for each port.

**Sample time** — Enter a base sample time or a multiple of the base sample time.

**PCI Slot (-1:autosearch)** — If only one board of this type is physically present in the target PC, enter

```
- 1
```

to automatically locate the board.

If two or more boards of this type are physically present in the target PC, enter the bus number and the PCI slot number of the board associated with this driver block. Use the format [BusNumber, SlotNumber]. To determine the bus number and the PCI slot number, type

```
getxpcpci
```

### PCI-DIO24H Digital Output

The PCI-DIO24H has one 8255 chip with 3 ports (A,B,C). Each port has a maximum of 8 digital I/O lines that can be configured as inputs or outputs.

Use a separate driver block for each port. By selecting the digital output driver block, the port is configured as output.

## Scaling Input to Output

| Hardware Output | Block Input Data Type | Scaling                             |
|-----------------|-----------------------|-------------------------------------|
| TTL             | Double                | < 0.5 = TTL low<br>≥ 0.5 = TTL high |

## Driver Block Parameters

**Channel vector** — Enter numbers between 1 and 8 to select the digital output lines used with this port. This driver allows the selection of individual digital output lines in any order. The number of elements defines the number of digital lines used.

For example, to use all of the digital outputs for one port, enter

```
[1,2,3,4,5,6,7,8]
```

Number the lines beginning with 1 even if the board manufacturer starts numbering the lines with 0.

**Port** — From the list choose either A, B, or C. The I/O board has a 8255 chip with 3 ports. The **Port** parameter defines which port of the 8255 chip is used for this driver block. Each port has a maximum of 8 digital lines that can be configured as inputs or outputs depending on which driver block is chosen. In each case, one block is needed for each port.

**Reset vector** — The reset vector controls the behavior of the channel at model termination. Enter a scalar or a vector that is the same length as the channel vector. If you specify a scalar value, that setting is used for all channels. If you specify a value of 1, the corresponding channel is reset to the value specified in the initial value vector. If you specify a value of 0, the channel remains at the last value attained while the model was running.

**Initial value vector** — The initial value vector contains the initial values (0 or 1) of the output channels. Enter a scalar or a vector that is the same length as the channel vector. If you enter a scalar, that value is used for all channels. The channels are set to these initial values between the time the model is downloaded and the time it is started.

**Sample time** — Enter a base sample time or a multiple of the base sample time.

**PCI Slot (-1:autosearch)** — If only one board of this type is physically present in the target PC, enter

-1

to automatically locate the board.

If two or more boards of this type are physically present in the target PC, enter the bus number and the PCI slot number of the board associated with this driver block. Use the format [BusNumber, SlotNumber]. To determine the bus number and the PCI slot number, type

```
getxpcpci
```

## PCI-DIO48H

The PCI-DIO48H is an I/O board with 48 digital I/O lines.

xPC Target supports this board with these driver blocks:

- “PCI-DIO48H Digital Input” on page 21-211
- “PCI-DIO48H Digital Output” on page 21-212

### Board Characteristics

|                                 |                |
|---------------------------------|----------------|
| Board name                      | PCI-DIO48H     |
| Manufacturer                    | ComputerBoards |
| Bus type                        | PCI            |
| Access method                   | I/O mapped     |
| Multiple block instance support | Yes            |
| Multiple board support          | Yes            |

### PCI-DIO48H Digital Input

The PCI-DIO48H has two 8255 chips (1,2). Each chip has three ports (A,B,C). Each port has a maximum of 8 digital I/O lines that can be configured as inputs or outputs.

Use a separate driver block for each port. By selecting the digital input driver block, the port is configured as input.

### Scaling Input to Output

| Hardware Input | Block Output Data Type | Scaling                         |
|----------------|------------------------|---------------------------------|
| TTL            | Double                 | TTL low = 0.0<br>TTL high = 1.0 |

### Driver Block Parameters

**Channel vector** — Enter numbers between 1 and 8 to select the digital input lines used with this port. This driver allows the selection of individual digital

input lines in any order. The number of elements defines the number of digital lines used.

For example, to use all of the digital inputs for one port, enter

```
[1,2,3,4,5,6,7,8]
```

Number the lines beginning with 1 even if the board manufacturer starts numbering the lines with 0.

**Port** — From the list choose either A, B, or C. The I/O board has two 8255 chips with 3 ports. The **Port** parameter defines which port of the 8255 chip is used for this driver block. Each port has a maximum of 8 digital lines that can be configured as inputs or outputs depending on which driver block is chosen. In each case, one block is needed for each port.

**Chip** — From the list choose 1 or 2. The **Chip** parameter defines which of the two 8255 chips is used.

**Sample time** — Enter a base sample time or a multiple of the base sample time.

**PCI Slot (-1:autosearch)** — If only one board of this type is physically present in the target PC, enter

```
-1
```

to automatically locate the board.

If two or more boards of this type are physically present in the target PC, enter the bus number and the PCI slot number of the board associated with this driver block. Use the format [BusNumber, SlotNumber]. To determine the bus number and the PCI slot number, type

```
getxpcpci
```

## PCI-DIO48H Digital Output

The PCI-DIO48H has two 8255 chips (1,2). Each chip has three ports (A,B,C). Each port has a maximum of 8 digital I/O lines that can be configured as inputs or outputs.

Use a separate driver block for each port. By selecting the digital output driver block, the port is configured as output.

## Scaling Input to Output

| Hardware Output | Block Input Data Type | Scaling                             |
|-----------------|-----------------------|-------------------------------------|
| TTL             | Double                | < 0.5 = TTL low<br>≥ 0.5 = TTL high |

### Driver Block Parameters

**Channel vector** — Enter numbers between 1 and 8 to select the digital output lines used with this port. This driver allows the selection of individual digital output lines in any order. The number of elements defines the number of digital lines used.

For example, to use all of the digital inputs for one port, enter

```
[1,2,3,4,5,6,7,8]
```

Number the lines beginning with 1 even if the board manufacturer starts numbering the lines with 0.

**Port** — From the list choose either A, B, or C. The I/O board has two 8255 chips with 3 ports. The **Port** parameter defines which port of the 8255 chip is used for this driver block. Each port has a maximum of 8 digital lines that can be configured as inputs or outputs depending on which driver block is chosen. In each case, one block is needed for each port.

**Reset vector** — The reset vector controls the behavior of the channel at model termination. Enter a scalar or a vector that is the same length as the channel vector. If you specify a scalar value, that setting is used for all channels. If you specify a value of 1, the corresponding channel is reset to the value specified in the initial value vector. If you specify a value of 0, the channel remains at the last value attained while the model was running.

**Initial value vector** — The initial value vector contains the initial values (0 or 1) of the output channels. Enter a scalar or a vector that is the same length as the channel vector. If you enter a scalar, that value is used for all channels. The channels are set to these initial values between the time the model is downloaded and the time it is started.

**Chip** — From the list choose 1 or 2. The **Chip** parameter defines which of the two 8255 chips is used.

**Sample time** — Enter a base sample time or a multiple of the base sample time.

**PCI Slot (-1:autosearch)** — If only one board of this type is physically present in the target PC, enter

-1

to automatically locate the board.

If two or more boards of this type are physically present in the target PC, enter the bus number and the PCI slot number of the board associated with this driver block. Use the format [BusNumber, SlotNumber]. To determine the bus number and the PCI slot number, type

```
getxpcpci
```



## PCI-DIO96H

The PCI-DIO96H is an I/O board with 96 digital I/O lines.

xPC Target supports this board with these driver blocks:

- “PCI-DIO96H Digital Input” on page 21-215
- “PCI-DIO96H Digital Output” on page 21-216

### Board Characteristics

|                                 |                |
|---------------------------------|----------------|
| Board name                      | PCI-DIO96H     |
| Manufacturer                    | ComputerBoards |
| Bus type                        | PCI            |
| Access method                   | I/O mapped     |
| Multiple block instance support | Yes            |
| Multiple board support          | Yes            |

### PCI-DIO96H Digital Input

The PCI-DIO96H has four 8255 chips (1,2,3,4). Each chip has three ports (A,B,C). Each port has a maximum of 8 digital I/O lines that can be configured as inputs or outputs.

Use a separate driver block for each port. By selecting the digital input driver block, the port is configured as input.

### Scaling Input to Output

| Hardware Input | Block Output Data Type | Scaling                         |
|----------------|------------------------|---------------------------------|
| TTL            | Double                 | TTL low = 0.0<br>TTL high = 1.0 |

### Driver Block Parameters

**Channel vector** — Enter numbers between 1 and 8 to select the digital input lines used with this port. This driver allows the selection of individual digital

input lines in any order. The number of elements defines the number of digital lines used.

For example, to use all of the digital inputs for one port, enter

```
[1,2,3,4,5,6,7,8]
```

Number the lines beginning with 1 even if the board manufacturer starts numbering the lines with 0.

**Port** — From the list choose either A, B, or C. The I/O board has two 8255 chips with 3 ports. The **Port** parameter defines which port of the 8255 chip is used for this driver block. Each port has a maximum of 8 digital lines that can be configured as inputs or outputs depending on which driver block is chosen. In each case, one block is needed for each port.

**Chip** — From the list choose 1, 2, 3, or 4. The **Chip** parameter defines which of the four 8255 chips is used.

**Sample time** — Enter a base sample time or a multiple of the base sample time.

**PCI Slot (-1:autosearch)** — If only one board of this type is physically present in the target PC, enter

```
-1
```

to automatically locate the board.

If two or more boards of this type are physically present in the target PC, enter the bus number and the PCI slot number of the board associated with this driver block. Use the format [BusNumber, SlotNumber]. To determine the bus number and the PCI slot number, type

```
getxpcpci
```

## **PCI-DIO96H Digital Output**

The PCI-DIO96H has four 8255 chips (1,2,3,4). Each chip has three ports (A,B,C). Each port has a maximum of 8 digital I/O lines that can be configured as inputs or outputs.

Use a separate driver block for each port. By selecting the digital output driver block, the port is configured as output.

## Scaling Input to Output

| Hardware Output | Block Input Data Type | Scaling                             |
|-----------------|-----------------------|-------------------------------------|
| TTL             | Double                | < 0.5 = TTL low<br>≥ 0.5 = TTL high |

### Driver Block Parameters

**Channel vector** — Enter numbers between 1 and 8 to select the digital output lines used with this port. This driver allows the selection of individual digital output lines in any order. The number of elements defines the number of digital lines used.

For example, to use all of the digital inputs for one port, enter

```
[1,2,3,4,5,6,7,8]
```

Number the lines beginning with 1 even if the board manufacturer starts numbering the lines with 0.

**Port** — From the list choose either A, B, or C. The I/O board has two 8255 chips with 3 ports. The **Port** parameter defines which port of the 8255 chip is used for this driver block. Each port has a maximum of 8 digital lines that can be configured as inputs or outputs depending on which driver block is chosen. In each case, one block is needed for each port.

**Reset vector** — The reset vector controls the behavior of the channel at model termination. Enter a scalar or a vector that is the same length as the channel vector. If you specify a scalar value, that setting is used for all channels. If you specify a value of 1, the corresponding channel is reset to the value specified in the initial value vector. If you specify a value of 0, the channel remains at the last value attained while the model was running.

**Initial value vector** — The initial value vector contains the initial values (0 or 1) of the output channels. Enter a scalar or a vector that is the same length as the channel vector. If you enter a scalar, that value is used for all channels. The channels are set to these initial values between the time the model is downloaded and the time it is started.

**Chip** — From the list choose 1, 2, 3, or 4. The **Chip** parameter defines which of the four 8255 chips is used.

**Sample time** — Enter a base sample time or a multiple of the base sample time.

**PCI Slot (-1:autosearch)** — If only one board of this type is physically present in the target PC, enter

-1

to automatically locate the board.

If two or more boards of this type are physically present in the target PC, enter the bus number and the PCI slot number of the board associated with this driver block. Use the format [BusNumber, SlotNumber]. To determine the bus number and the PCI slot number, type

```
getxpcpci
```

## PCI-DIO96

The PCI-DIO96 is an I/O board with 96 digital I/O lines.

xPC Target supports this board with these driver blocks:

- “PCI-DIO96 Digital Input” on page 21-219
- “PCI-DIO96 Digital Output” on page 21-220

### Board Characteristics

|                                 |                |
|---------------------------------|----------------|
| Board name                      | PCI-DIO96      |
| Manufacturer                    | ComputerBoards |
| Bus type                        | PCI            |
| Access method                   | I/O mapped     |
| Multiple block instance support | Yes            |
| Multiple board support          | Yes            |

### PCI-DIO96 Digital Input

The PCI-DIO96 has four 8255 chips (1,2,3,4). Each chip has three ports (A,B,C). Each port has a maximum of 8 digital I/O lines that can be configured as inputs or outputs.

Use a separate driver block for each port. By selecting the digital input driver block, the port is configured as input.

### Scaling Input to Output

| Hardware Input | Block Output Data Type | Scaling                         |
|----------------|------------------------|---------------------------------|
| TTL            | Double                 | TTL low = 0.0<br>TTL high = 1.0 |

### Driver Block Parameters

**Channel vector** — Enter numbers between 1 and 8 to select the digital input lines used with this port. This driver allows the selection of individual digital

input lines in any order. The number of elements defines the number of digital lines used.

For example, to use all of the digital inputs for one port, enter

```
[1,2,3,4,5,6,7,8]
```

Number the lines beginning with 1 even if the board manufacturer starts numbering the lines with 0.

**Port** — From the list choose either A, B, or C. The **Port** parameter defines which port of the current 8255 chip is used for this driver block.

**Chip** — From the list choose 1, 2, 3, or 4. The **Chip** parameter defines which of the four 8255 chips is used.

**Sample time** — Enter a base sample time or a multiple of the base sample time.

**PCI Slot (-1:autosearch)** — If only one board of this type is physically present in the target PC, enter

```
-1
```

to automatically locate the board.

If two or more boards of this type are physically present in the target PC, enter the bus number and the PCI slot number of the board associated with this driver block. Use the format [BusNumber, SlotNumber]. To determine the bus number and the PCI slot number, type

```
getxpcpci
```

## **PCI-DIO96 Digital Output**

The PCI-DIO96 has four 8255 chips (1,2,3,4). Each chip has three ports (A,B,C). Each port has a maximum of 8 digital I/O lines that can be configured as inputs or outputs.

Use a separate driver block for each port. By selecting the digital output driver block, the port is configured as output.

## Scaling Input to Output

| Hardware Output | Block Input Data Type | Scaling                             |
|-----------------|-----------------------|-------------------------------------|
| TTL             | Double                | < 0.5 = TTL low<br>≥ 0.5 = TTL high |

### Driver Block Parameters

**Channel vector** — Enter numbers between 1 and 8 to select the digital output lines used with this port. This driver allows the selection of individual digital output lines in any order. The number of elements defines the number of digital lines used.

For example, to use all of the digital inputs for one port, enter

```
[1,2,3,4,5,6,7,8]
```

Number the lines beginning with 1 even if the board manufacturer starts numbering the lines with 0.

**Port** — From the list choose either A, B, or C. The **Port** parameter defines which port of the current 8255 chip is used for this driver block.

**Reset vector** — The reset vector controls the behavior of the channel at model termination. Enter a scalar or a vector that is the same length as the channel vector. If you specify a scalar value, that setting is used for all channels. If you specify a value of 1, the corresponding channel is reset to the value specified in the initial value vector. If you specify a value of 0, the channel remains at the last value attained while the model was running.

**Initial value vector** — The initial value vector contains the initial values (0 or 1) of the output channels. Enter a scalar or a vector that is the same length as the channel vector. If you enter a scalar, that value is used for all channels. The channels are set to these initial values between the time the model is downloaded and the time it is started.

**Chip** — From the list choose 1, 2, 3, or 4. The **Chip** parameter defines which of the four 8255 chips is used.

**Sample time** — Enter a base sample time or a multiple of the base sample time.

**PCI Slot (-1:autosearch)** — If only one board of this type is physically present in the target PC, enter

-1

to automatically locate the board.

If two or more boards of this type are physically present in the target PC, enter the bus number and the PCI slot number of the board associated with this driver block. Use the format [BusNumber, SlotNumber]. To determine the bus number and the PCI slot number, type

```
getxpcpci
```



## PCI-PDISO8

The PCI-PDISO8 is an I/O board with eight inputs and eight relay outputs. xPC Target supports this board with these driver blocks:

- “PCI-PDISO8 Digital Input” on page 21-223
- “PCI-PDISO8 Digital Output” on page 21-225

### Board Characteristics

|                                 |                |
|---------------------------------|----------------|
| Board name                      | PCI-PDISO8     |
| Manufacturer                    | ComputerBoards |
| Bus type                        | PCI            |
| Access method                   | Memory mapped  |
| Multiple block instance support | Yes            |
| Multiple board support          | Yes            |

## PCI-PDISO8 Digital Input

### Scaling Input to Output

| Hardware Input | Block Output Data Type | Scaling                                      |
|----------------|------------------------|----------------------------------------------|
| OPTO           | Double                 | Low (opto off) = 0.0<br>High (opto on) = 1.0 |

The input is rectified before being applied to the opto isolator on the input. With no additional input current limiting resistor, the opto turns on when  $|V_{in}| > 3$  volts.

### Driver Block Parameters

**Channel vector** — Enter numbers between 1 and 8 to select the digital input lines used with this port. This driver allows the selection of individual digital input lines in any order. The number of elements defines the number of digital lines used.

For example, to use all of the digital inputs, enter

```
[1,2,3,4,5,6,7,8]
```

Number the lines beginning with 1 even though the board manufacturer starts numbering the lines with 0.

**Filter vector** — This vector controls the 5 ms noise filter. It is the same length as the channel vector. A value of 1 turns the filter on, and a value of 0 turns the filter off. If you specify a scalar, this value is applied to all channels.

**Port** — From the list choose A because this board only has eight channels.

**Sample time** — Enter a base sample time or a multiple of the base sample time.

**PCI Slot (-1:autosearch)** — If only one board of this type is physically present in the target PC, enter

```
-1
```

to automatically locate the board.

If two or more boards of this type are physically present in the target PC, enter the bus number and the PCI slot number of the board associated with this driver block. Use the format [BusNumber, SlotNumber]. To determine the bus number and the PCI slot number, type

```
getxpcpci
```

## PCI-PDISO8 Digital Output

### Scaling Input to Output

| Hardware Output | Block Input Data Type | Scaling                               |
|-----------------|-----------------------|---------------------------------------|
| RELAY           | Double                | < 0.5 = relay off<br>≥ 0.5 = relay on |

### Driver Block Parameters

**Channel vector** — Enter numbers between 1 and 8 to select the digital output lines to drive. This driver allows the selection of individual digital output lines in any order. The number of elements defines the number of digital lines used.

For example, to use all of the digital outputs, enter

```
[1,2,3,4,5,6,7,8]
```

Number the lines beginning with 1 even though the board manufacturer starts numbering the lines with 0.

**Port** — From the list choose A because this board only has eight channels.

**Sample time** — Enter a base sample time or a multiple of the base sample time.

**PCI Slot (-1:autosearch)** — If only one board of this type is physically present in the target PC, enter

```
-1
```

to automatically locate the board.

If two or more boards of this type are physically present in the target PC, enter the bus number and the PCI slot number of the board associated with this driver block. Use the format [BusNumber, SlotNumber]. To determine the bus number and the PCI slot number, type

```
getxpcpci
```

## PCI-PDISO16

The PCI-PDISO16 is an I/O board with 16 inputs and 16 relay outputs. xPC Target supports this board with these driver blocks:

- “PCI-PDISO16 Digital Input” on page 21-226
- “PCI-PDISO16 Digital Output” on page 21-228

### Board Characteristics

|                                 |                |
|---------------------------------|----------------|
| Board name                      | PCI-PDISO16    |
| Manufacturer                    | ComputerBoards |
| Bus type                        | PCI            |
| Access method                   | Memory mapped  |
| Multiple block instance support | Yes            |
| Multiple board support          | Yes            |

## PCI-PDISO16 Digital Input

### Scaling Input to Output

| Hardware Input | Block Output Data Type | Scaling                                      |
|----------------|------------------------|----------------------------------------------|
| OPTO           | Double                 | Low (opto off) = 0.0<br>High (opto on) = 1.0 |

The input is rectified before being applied to the opto isolator on the input. With no additional input current limiting resistor, the opto turns on when  $|V_{in}| > 3$  volts.

### Driver Block Parameters

**Channel vector** — Enter numbers between 1 and 8 to select the digital input lines used with this port. This driver allows the selection of individual digital input lines in any order. The number of elements defines the number of digital lines used.

For example, to use all of the digital inputs, enter

```
[1,2,3,4,5,6,7,8]
```

Number the lines beginning with 1 even though the board manufacturer starts numbering the lines with 0.

**Filter vector** — This vector controls the 5 ms noise filter. It is the same length as the channel vector. A value of 1 turns the filter on, and a value of 0 turns the filter off. If you specify a scalar, this value is applied to all channels.

**Port** — From the list choose either A or B. The **Port** parameter defines which port is used for this driver block. Each port has a maximum of 8 digital inputs. More than one block can be connected to the same port, but each channel can only be referenced by one block at a time.

**Sample time** — Enter a base sample time or a multiple of the base sample time.

**PCI Slot (-1:autosearch)** — If only one board of this type is physically present in the target PC, enter

```
-1
```

to automatically locate the board.

If two or more boards of this type are physically present in the target PC, enter the bus number and the PCI slot number of the board associated with this driver block. Use the format [BusNumber, SlotNumber]. To determine the bus number and the PCI slot number, type

```
getxpcpci
```

## PCI-PDISO16 Digital Output

### Scaling Input to Output

| Hardware Output | Block Input Data Type | Scaling                               |
|-----------------|-----------------------|---------------------------------------|
| RELAY           | Double                | < 0.5 = relay off<br>≥ 0.5 = relay on |

### Driver Block Parameters

**Channel vector** — Enter numbers between 1 and 8 to select the digital output lines to drive. This driver allows the selection of individual digital output lines in any order. The number of elements defines the number of digital lines used.

For example, to use all of the digital outputs, enter

```
[ 1, 2, 3, 4, 5, 6, 7, 8]
```

Number the lines beginning with 1 even though the board manufacturer starts numbering the lines with 0.

**Port** — From the list choose either A or B. The **Port** parameter defines which port is used for this driver block. Each port has a maximum of 8 digital outputs. More than one output block can be used with the same port, but each output channel can only be controlled by one block at a time.

**Sample time** — Enter a base sample time or a multiple of the base sample time.

**PCI Slot (-1:autosearch)** — If only one board of this type is physically present in the target PC, enter

```
- 1
```

to automatically locate the board.

If two or more boards of this type are physically present in the target PC, enter the bus number and the PCI slot number of the board associated with this driver block. Use the format [BusNumber, SlotNumber]. To determine the bus number and the PCI slot number, type

```
getxpcpci
```

## PCIM-DAS1602/16

The PCIM-DAS1602/16 is an I/O board with 16 single or 8 differential analog input (A/D) channels (16-bit) with a maximum sampling rate of 100kHz, 2 analog output (D/A) channels (16-bit), and 24 digital input and output lines and 3 counters (16-bit).

xPC Target supports this board with these driver blocks:

- “PCIM-DAS1602/16 Analog Input (A/D)” on page 21-230
- “PCIM-DAS1602/16 Analog Output (D/A)” on page 21-231
- “PCIM-DAS 1602/16 Digital Input” on page 21-233
- “PCIM-DAS1602/16 Digital Output” on page 21-234

---

**Note** xPC Target supports only 24 digital I/O lines and does not support the counters on this board.

---

### Board Characteristics

|                                 |                 |
|---------------------------------|-----------------|
| Board Name                      | PCIM-DAS1602/16 |
| Manufacturer                    | ComputerBoards  |
| Bus type                        | PCI             |
| Access method                   | I/O mapped      |
| Multiple block instance support | Yes             |
| Multiple board support          | Yes             |

## PCIM-DAS1602/16 Analog Input (A/D)

### Scaling of Input to Output

| Hardware Input | Block Output Data Type | Scaling |
|----------------|------------------------|---------|
| volts          | Double                 | 1       |

### Driver Block Parameters

**Number of channels** — If you select 16 channels (**Input coupling** parameter set to 16 single-ended channels) enter a number between 1 and 16 to select the number of A/D channels used. If you select eight channels (**Input coupling** parameter set to 8 differential channels) enter a number between 1 and 8. This driver does not allow the selection of individual channels or to mix single-ended and differential inputs.

Number the lines beginning with 1 even if the board manufacturer starts numbering the lines with 0.

**Range** — From the list, choose either +-10V (-10 volts to +10 volts), +-5V, +-2.5V, +-1.25V, +-0.625V, 0-10V, 0-5V, 0-2.5V, or 0-1.25V. This driver does not allow the selection of a different range for each channel.

If a bipolar range is used, the bipolar switch on the board must be in the bipolar position. If a unipolar range is used, the bipolar switch must be in the unipolar position.

**Input coupling** — From the list, select one from the following list of input modes:

- Single-ended channels (16 channels)
- Differential channels (8 channels)

This choice must correspond to the MUX-switch setting on the board.

**Sample time** — Enter the base sample time or a multiple of the base sample time.



**PCI Slot (-1:autosearch)** — If only one board of this type is physically present in the target PC, enter

-1

to automatically locate the board.

If two or more boards of this type are physically present in the target PC, enter the bus number and the PCI slot number of the board associated with this driver block. Use the format [BusNumber, SlotNumber]. To determine the bus number and the PCI slot number, type

```
getxpcpci
```

## PCIM-DAS1602/16 Analog Output (D/A)

### Scaling of Input to Output

| Hardware Output | Block Input Data Type | Scaling |
|-----------------|-----------------------|---------|
| volts           | Double                | 1       |

### Driver Block Parameters

**Channel vector** — Enter 1 or 2. This driver allows the selection of individual D/A channels in any order. The number of elements defines the number of D/A channels used. For example, to use the first and second analog output (D/A) channels, enter

```
[1,2]
```

Number channels begin with 1 even if the board manufacturer starts numbering channels with 0.

**Range vector** — Enter a range code for each of the channels in the channel vector. The range vector must be the same length as the channel vector. This board allows the range of each channel to be different.

The following table is a list of the ranges for this driver and the corresponding range codes.

| <b>Input Range (V)</b> | <b>Range Code</b> | <b>Input Range (V)</b> | <b>Range Code</b> |
|------------------------|-------------------|------------------------|-------------------|
| -10 to +10             | -10               | 0 - 10                 | 10                |
| -5 to +5               | -5                | 0 - 5                  | 5                 |

For example, if the first channel is -10 to +10 volts, and the second channel is 0 to 5 volts, enter

[ - 10, 5 ]

The range settings have to correspond to the DIP switch settings on the board. Also the Bipolar/ Unipolar jumpers have to be inserted according to the ranges used.

**Reset vector** — The reset vector controls the behavior of the channel at model termination. Enter a scalar or a vector that is the same length as the channel vector. If you specify a scalar value, that setting is used for all channels. If you specify a value of 1, the corresponding channel is reset to the value specified in the initial value vector. If you specify a value of 0, the channel remains at the last value attained while the model was running.

**Initial value vector** — The initial value vector contains the initial voltage values for the output channels. Enter a scalar or a vector that is the same length as the channel vector. If you specify a scalar value, that value is the initial value for all channels. The channels are set to the initial values between the time the model is downloaded and the time it is started.

**Sample time** — Base sample time of a multiple of the base sample time.

**PCI Slot (-1:autosearch)** — If only one board of this type is physically present in the target PC, enter

- 1

to automatically locate the board.

If two or more boards of this type are physically present in the target PC, enter the bus number and the PCI slot number of the board associated with this driver block. Use the format [BusNumber, SlotNumber]. To determine the bus number and the PCI slot number, type

```
getxpcpci
```

## PCIM-DAS 1602/16 Digital Input

The DAS1601/16 has a 8255 chip with 3 ports (A,B,C). Each port has a maximum of 8 digital I/O lines that can be configured as inputs or outputs.

Use a separate driver block for each port. By selecting the digital input driver block, the port is configured as input.

### Scaling of Input to Output

| Hardware Input | Block Output Data Type | Scaling                         |
|----------------|------------------------|---------------------------------|
| TTL            | Double                 | TTL low = 0.0<br>TTL high = 1.0 |

### Driver Block Parameters

**Channel vector** — Enter numbers between 1 and 8 to select the digital input lines used with this port. This driver allows the selection of individual digital input lines in any order. The number of elements defines the number of digital lines used.

For example, to use all of the digital inputs for one port, enter

```
[1,2,3,4,5,6,7,8]
```

Number the lines beginning with 1 even if the board manufacturer starts numbering the lines with 0.

**Port** — From the list choose either A, B, or C. The I/O board has a 8255 chip with 3 ports. The port name defines which port of the 8255 chip is used for this driver block. Each port has a maximum of 8 digital lines that can be configured as inputs or outputs depending on which driver block is chosen. In each case, one block is needed for each port.

**Sample time** — Enter a base sample time or a multiple of the base sample time.

**PCI Slot (-1:autosearch)** — If only one board of this type is physically present in the target PC, enter

-1

to automatically locate the board.

If two or more boards of this type are physically present in the target PC, enter the bus number and the PCI slot number of the board associated with this driver block. Use the format [BusNumber, SlotNumber]. To determine the bus number and the PCI slot number, type

```
getxpcpci
```

## PCIM-DAS1602/16 Digital Output

The PCIM-DAS1601/16 has a 8255 chip with 3 ports (A,B,C). Each port has a maximum of 8 digital I/O lines that can be configured as inputs or outputs.

Use a separate driver block for each port. By selecting the digital output driver block, the port is configured as output.

### Scaling of Input to Output

| Hardware Output | Block Input Data Type | Scaling                             |
|-----------------|-----------------------|-------------------------------------|
| TTL             | Double                | < 0.5 = TTL low<br>≥ 0.5 = TTL high |

### Driver Block Parameters

**Channel vector** — Enter numbers between 1 and 8 to select the digital output lines used with this port. This driver allows the selection of individual digital output lines in any order. The number of elements defines the number of digital lines used.

For example, to use all of the digital outputs for one port, enter

```
[1,2,3,4,5,6,7,8]
```

Number the lines beginning with 1 even if the board manufacturer starts numbering the lines with 0.

**Port** — From the list choose either A, B, or C. The I/O board has a 8255 chip with 3 ports. The port name defines which port of the 8255 chip is used for this driver block. Each port has a maximum of 8 digital lines that can be configured as inputs or outputs depending on which driver block is chosen. In each case, one block is needed for each port.

**Reset vector** — The reset vector controls the behavior of the channel at model termination. Enter a scalar or a vector that is the same length as the channel vector. If you specify a scalar value, that setting is used for all channels. If you specify a value of 1, the corresponding channel is reset to the value specified in the initial value vector. If you specify a value of 0, the channel remains at the last value attained while the model was running.

**Initial value vector** — The initial value vector contains the initial values (0 or 1) of the output channels. Enter a scalar or a vector that is the same length as the channel vector. If you enter a scalar, that value is used for all channels. The channels are set to these initial values between the time the model is downloaded and the time it is started.

**Sample time** — Enter a base sample time or a multiple of the base sample time.

**PCI Slot (-1:autosearch)** — If only one board of this type is physically present in the target PC, enter

-1

to automatically locate the board.

If two or more boards of this type are physically present in the target PC, enter the bus number and the PCI slot number of the board associated with this driver block. Use the format [BusNumber, SlotNumber]. To determine the bus number and the PCI slot number, type

```
getxpcpci
```

## PCIM-DDA06/16

The PCIM-DDA06/16 is an I/O board with 6 analog output (D/A) channels (16-bit), and 24 digital I/O lines.

xPC Target supports this board with these driver blocks:

- “PCIM-DDA06/16 Analog Output (D/A)” on page 21-236
- “PCIM-DDA06/16 Digital Input” on page 21-238
- “PCIM-DDA06/16 Digital Output” on page 21-239

### Board Characteristics

|                                 |                 |
|---------------------------------|-----------------|
| Board name                      | PCIM-DDA06/16   |
| Manufacturer                    | Computer Boards |
| Bus type                        | PCIM            |
| Access method                   | I/O mapped      |
| Multiple block instance support | Yes             |
| Multiple board support          | Yes             |

### PCIM-DDA06/16 Analog Output (D/A)

#### Scaling Input to Output

| Hardware Output | Block Input Data Type | Scaling |
|-----------------|-----------------------|---------|
| volts           | Double                | 1       |

#### Driver Block Parameters

**Channel vector** — Enter numbers between 1 and 6. This driver allows the selection of individual D/A channels in any order. The number of elements defines the number of D/A channels used. For example, to use the first and second analog output channels, enter

[1,2]

Number the channels beginning with 1 even if the board manufacturer starts numbering the channels with 0.

**Range vector** — Enter a range code for each of the channels in the channel vector. The range vector must be the same length as the channel vector. This board allows the range of each channel to be different.

The following table is a list of the ranges for this driver and the corresponding range codes.

| Input Range (V) | Range Code | Input Range (V) | Range Code |
|-----------------|------------|-----------------|------------|
| -10 to +10      | -10        | 0 to 10         | 10         |
| -5 to +5        | -5         | 0 to +5         | 5          |
| -2.5 to +2.5    | -2.5       | 0 to +2.5       | 2.5        |
| -1.67 to +1.67  | -1.67      | 0 to +1.67      | 1.67       |
| -.625 to +.625  | -0.625     |                 |            |

For example, if the first channel is -10 to +10 volts, and the second channel is 0 to 5 volts, enter

[ -10,5]

The range settings have to correspond to the DIP switch settings on the board.

---

**Note** For xPC Target, set the Simultaneous Transfer jumper to the XFER setting.

---

**Reset vector** — The reset vector controls the behavior of the channel at model termination. Enter a scalar or a vector that is the same length as the channel vector. If you specify a scalar value, that setting is used for all channels. If you specify a value of 1, the corresponding channel is reset to the value specified in the initial value vector. If you specify a value of 0, the channel remains at the last value attained while the model was running.

**Initial value vector** — The initial value vector contains the initial voltage values for the output channels. Enter a scalar or a vector that is the same length as the channel vector. If you specify a scalar value, that value is the initial value for all channels. The channels are set to the initial values between the time the model is downloaded and the time it is started.

**Sample time** — Base sample time of a multiple of the base sample time.

**PCI Slot (-1:autosearch)** — If only one board of this type is physically present in the target PC, enter

-1

to automatically locate the board.

If two or more boards of this type are physically present in the target PC, enter the bus number and the PCI slot number of the board associated with this driver block. Use the format [BusNumber, SlotNumber]. To determine the bus number and the PCI slot number, type

```
getxpcpci
```

## PCIM-DDA06/16 Digital Input

The PCIM-DDA6/16 has a 8255 chip with three ports (A,B,C). Each port has a maximum of 8 digital I/O lines that can be configured as inputs or outputs.

Use a separate driver block for each port. By selecting the digital input driver block, the port is configured as input.

### Scaling Input to Output

| Hardware Input | Block Output Data Type | Scaling                         |
|----------------|------------------------|---------------------------------|
| TTL            | Double                 | TTL low = 0.0<br>TTL high = 1.0 |

### Driver Block Parameters

**Channel vector** — Enter numbers between 1 and 8 to select the digital input lines used with this port. This driver allows the selection of individual digital input lines in any order. The number of elements defines the number of digital lines used.



For example, to use all of the digital inputs for one port, enter

```
[1,2,3,4,5,6,7,8]
```

Number the lines beginning with 1 even if the board manufacturer starts numbering the lines with 0.

**Port** — From the list choose either A, B, or C. The I/O board has two 8255 chips with 3 ports. The **Port** parameter defines which port of the 8255 chip is used for this driver block. Each port has a maximum of 8 digital lines that can be configured as inputs or outputs depending on which driver block is chosen. In each case, one block is needed for each port.

**Sample time** — Enter a base sample time or a multiple of the base sample time.

**PCI Slot (-1:autosearch)** — If only one board of this type is physically present in the target PC, enter

```
-1
```

to automatically locate the board.

If two or more boards of this type are physically present in the target PC, enter the bus number and the PCI slot number of the board associated with this driver block. Use the format [BusNumber, SlotNumber]. To determine the bus number and the PCI slot number, type

```
getxpcpci
```

## PCIM-DDA06/16 Digital Output

The PCIM-DDA06/16 has a 8255 chip with three ports (A,B,C). Each port has a maximum of 8 digital I/O lines that can be configured as inputs or outputs.

Use a separate driver block for each port. By selecting the digital output driver block, the port is configured as output.

## Scaling Input to Output

| Hardware Output | Block Input Data Type | Scaling                             |
|-----------------|-----------------------|-------------------------------------|
| TTL             | Double                | < 0.5 = TTL low<br>≥ 0.5 = TTL high |

### Driver Block Parameters

**Channel vector** — Enter numbers between 1 and 8 to select the digital output lines used with this port. This driver allows the selection of individual digital output lines in any order. The number of elements defines the number of digital lines used.

For example, to use all of the digital outputs for one port, enter

[ 1,2,3,4,5,6,7,8]

Number the lines beginning with 1 even if the board manufacturer starts numbering the lines with 0.

**Port** — From the list choose either A, B, or C. The I/O board has two 8255 chips with 3 ports. The **Port** parameter defines which port of the 8255 chip is used for this driver block. Each port has a maximum of 8 digital lines that can be configured as inputs or outputs depending on which driver block is chosen. In each case, one block is needed for each port.

**Reset vector** — The reset vector controls the behavior of the channel at model termination. Enter a scalar or a vector that is the same length as the channel vector. If you specify a scalar value, that setting is used for all channels. If you specify a value of 1, the corresponding channel is reset to the value specified in the initial value vector. If you specify a value of 0, the channel remains at the last value attained while the model was running.

**Initial value vector** — The initial value vector contains the initial values (0 or 1) of the output channels. Enter a scalar or a vector that is the same length as the channel vector. If you enter a scalar, that value is used for all channels. The channels are set to these initial values between the time the model is downloaded and the time it is started.

**Sample time** — Enter a base sample time or a multiple of the base sample time.

**PCI Slot (-1:autosearch)** — If only one board of this type is physically present in the target PC, enter

-1

to automatically locate the board.

If two or more boards of this type are physically present in the target PC, enter the bus number and the PCI slot number of the board associated with this driver block. Use the format [BusNumber, SlotNumber]. To determine the bus number and the PCI slot number, type

`getxpcpci`

## PCI-DUAL-AC5

The PCI-DUAL-AC5 is an I/O board with 48 digital I/O lines.

xPC Target supports this board with these driver blocks:

- “PCI-DUAL-AC5 Digital Input” on page 21-242
- “PCI-DUAL-AC5 Digital Output” on page 21-243

### Board Characteristics

|                                 |                |
|---------------------------------|----------------|
| Board name                      | PCI-DUAL-AC5   |
| Manufacturer                    | ComputerBoards |
| Bus type                        | compact PCI    |
| Access method                   | I/O mapped     |
| Multiple block instance support | Yes            |
| Multiple board support          | Yes            |

### PCI-DUAL-AC5 Digital Input

The PCI-DUAL-AC5 has two 8255 chips (1,2). Each chip has three ports (A,B,C). Each port has a maximum of 8 digital I/O lines that can be configured as inputs or outputs.

Use a separate driver block for each port. By selecting the digital input driver block, the port is configured as input.

### Scaling Input to Output

| Hardware Input | Block Output Data Type | Scaling                         |
|----------------|------------------------|---------------------------------|
| TTL            | Double                 | TTL low = 0.0<br>TTL high = 1.0 |

## Driver Block Parameters

**Channel vector** — Enter numbers between 1 and 8 to select the digital input lines used with this port. This driver allows the selection of individual digital input lines in any order. The number of elements defines the number of digital lines used.

For example, to use all of the digital inputs for one port, enter

```
[1,2,3,4,5,6,7,8]
```

Number the lines beginning with 1 even if the board manufacturer starts numbering the lines with 0.

**Port** — From the list choose either A, B, or C. The I/O board has two 8255 chips with 3 ports. The **Port** parameter defines which port of the 8255 chip is used for this driver block. Each port has a maximum of 8 digital lines that can be configured as inputs or outputs depending on which driver block is chosen. In each case, one block is needed for each port.

**Chip** — From the list choose 1 or 2. The **Chip** parameter defines which of the two 8255 chips is used.

**Sample time** — Enter a base sample time or a multiple of the base sample time.

**PCI Slot (-1:autosearch)** — If only one board of this type is physically present in the target PC, enter

```
-1
```

to automatically locate the board.

If two or more boards of this type are physically present in the target PC, enter the bus number and the PCI slot number of the board associated with this driver block. Use the format [BusNumber, SlotNumber]. To determine the bus number and the PCI slot number, type

```
getxpcpci
```

## PCI-DUAL-AC5 Digital Output

The PCI-DUAL-AC5 has two 8255 chips (1,2). Each chip has three ports (A,B,C). Each port has a maximum of 8 digital I/O lines that can be configured as inputs or outputs.

Use a separate driver block for each port. By selecting the digital output driver block, the port is configured as output.

### Scaling Input to Output

| Hardware Output | Block Input Data Type | Scaling                             |
|-----------------|-----------------------|-------------------------------------|
| TTL             | Double                | < 0.5 = TTL low<br>≥ 0.5 = TTL high |

### Driver Block Parameters

**Channel vector** — Enter numbers between 1 and 8 to select the digital output lines used with this port. This driver allows the selection of individual digital output lines in any order. The number of elements defines the number of digital lines used.

For example, to use all of the digital inputs for one port, enter

[ 1, 2, 3, 4, 5, 6, 7, 8 ]

Number the lines beginning with 1 even if the board manufacturer starts numbering the lines with 0.

**Port** — From the list choose either A, B, or C. The I/O board has two 8255 chips with 3 ports. The **Port** parameter defines which port of the 8255 chip is used for this driver block. Each port has a maximum of 8 digital lines that can be configured as inputs or outputs depending on which driver block is chosen. In each case, one block is needed for each port.

**Reset vector** — The reset vector controls the behavior of the channel at model termination. Enter a scalar or a vector that is the same length as the channel vector. If you specify a scalar value, that setting is used for all channels. If you specify a value of 1, the corresponding channel is reset to the value specified in the initial value vector. If you specify a value of 0, the channel remains at the last value attained while the model was running.

**Initial value vector** — The initial value vector contains the initial values (0 or 1) of the output channels. Enter a scalar or a vector that is the same length as the channel vector. If you enter a scalar, that value is used for all channels. The channels are set to these initial values between the time the model is downloaded and the time it is started.

**Chip** — From the list choose 1 or 2. The **Chip** parameter defines which of the two 8255 chips is used.

**Sample time** — Enter a base sample time or a multiple of the base sample time.

**PCI Slot (-1:autosearch)** — If only one board of this type is physically present in the target PC, enter

-1

to automatically locate the board.

If two or more boards of this type are physically present in the target PC, enter the bus number and the PCI slot number of the board associated with this driver block. Use the format [BusNumber, SlotNumber]. To determine the bus number and the PCI slot number, type

```
getxpcpci
```

## PCI-QUAD04

The PCI-QUAD04 is a 24-bit counting board with 4 channels. This board typically connects to incremental encoders. Incremental encoders convert physical motion into electrical pulses that can be used to determine velocity, direction, and distance.

xPC Target supports this board with this driver block:

- “PCI-QUAD04 Incremental Encoder” on page 21-247

See “PCI-QUAD04 Incremental Encoder (Obsolete)” on page 21-251 if you have an earlier version of this driver.

Note on usage

There is a hardware limitation with the PCI-Quad04 boards in the way that they handle unconnected inputs. Even with the **Index input resets counter** check box disabled, noise on the index input line might cause the counter chip on the board to latch an incorrect value. This value differs from the correct value by a multiple of 256. The frequency of occurrence of the bad reads depends on the count frequency coming from the encoder. High count rates result in more bad reads.

To work around this issue, try the following:

- 1** If the index signal from an encoder is not being used, connect the index inputs.
- 2** Connect the index+ input to +5 volts.
- 3** Connect the index- input to ground.

These connections should be made as close to the board as possible to minimize any crosstalk at high count frequencies.



## Board Characteristics

|                                 |                |
|---------------------------------|----------------|
| Board name                      | PCI-QUAD04     |
| Manufacturer                    | ComputerBoards |
| Bus type                        | PCI            |
| Access method                   | I/O mapped     |
| Multiple block instance support | Yes            |
| Multiple board support          | Yes            |

## PCI-QUAD04 Incremental Encoder

This driver block has one block output: **Count**.

The raw count value is a 24-bit integer that is converted to a double precision float output from the block. The 24-bit value can be interpreted in different ways (see **Count Range**).

In this section, the clockwise direction is the direction in which the counter increments. The counterclockwise direction is the direction in which the counter decrements. Note that the counter direction depends on the encoder manufacturer and the way in which the encoder is installed.

---

**Note** If you are using an earlier version of this driver block, see the description at the end of this section.

---

### Driver Block Parameters

**Channel** — From the list, choose 1, 2, 3, or 4. This parameter specifies the channel you use for this block. For the same board (same PCI slot) two blocks cannot have the same channel number.

**Index input resets counter** — Choose this check box to control the behavior when the index is reached. For example, a rotary encoder typically reaches the index at one particular position in its range of motion. Setting this check box to reset the count value allows you to get a repeatable position from an encoder. When the encoder reaches the index (asserts the index), the counter value is set to the value given in the **Count Limit or Reset Value** field.

**Index Polarity** — From the list, select the index pulse slope that the board should detect. Select **Positive Index** for a positive slope; select **Negative Index** for a negative slope.

**Counting Mode** — From the list, select a counting mode (Normal, Range Limit, Non-recycle, or Modulo-N). The output of the block depends on both the setting of **Index input resets counter** and on the counting mode as described in the following table.

| <b>Counting Mode</b> | <b>Index input resets counter Selected</b>                                                                                                                                                                                                                                                                                                                                                                                                                                                                                                                                                                   | <b>Index input resets counter Deselected</b>                                                                                                                                                                                                                                                                                                                                      |
|----------------------|--------------------------------------------------------------------------------------------------------------------------------------------------------------------------------------------------------------------------------------------------------------------------------------------------------------------------------------------------------------------------------------------------------------------------------------------------------------------------------------------------------------------------------------------------------------------------------------------------------------|-----------------------------------------------------------------------------------------------------------------------------------------------------------------------------------------------------------------------------------------------------------------------------------------------------------------------------------------------------------------------------------|
| Normal               | <p>Upon model start, the output count is initialized to <b>Count Limit or Reset Value</b>. The output count increments or decreases one full revolution from the <b>Count Limit or Reset Value</b>. The output count is reset to this value each time the index is reached.</p> <p>For example, if <b>Index input resets counter</b> is selected, and a rotary encoder has 1024 counts per revolution, and a <b>Count Limit or Reset Value</b> value of 5000, a full clockwise revolution of the encoder increments the counter to 6023, at which the index is reached. The counter then resets to 5000.</p> | <p>Upon model start, the counter is initialized to 0. The counter then increments or decrements until it either overflows or underflows. For a rotary encoder, the number of revolutions is the number of output counts divided by the number of counts per revolution. The resulting integer is the number of revolutions; the fractional part can be converted to an angle.</p> |

| <b>Counting Mode</b> | <b>Index input resets counter Selected</b>                                                                                                                                                                                                                                                                                                                                                                                                                                                                                                                            | <b>Index input resets counter Deselected</b>                                                                                                                                                                                                                                                                                                                                                                                                                                                                                                                     |
|----------------------|-----------------------------------------------------------------------------------------------------------------------------------------------------------------------------------------------------------------------------------------------------------------------------------------------------------------------------------------------------------------------------------------------------------------------------------------------------------------------------------------------------------------------------------------------------------------------|------------------------------------------------------------------------------------------------------------------------------------------------------------------------------------------------------------------------------------------------------------------------------------------------------------------------------------------------------------------------------------------------------------------------------------------------------------------------------------------------------------------------------------------------------------------|
| Range Limit          | <p>Upon model start, the counter increments or decrements until it reaches the count limit <b>Count Limit or Reset Value</b>. If the clock motion is clockwise, the counter stays at <b>Count Limit or Reset Value</b> once it reaches that value. If the clock motion is counterclockwise, the counter decrements one revolution then resets to <b>Count Limit or Reset Value</b>.</p>                                                                                                                                                                               | <p>Upon model start, the counter is initialized to 0. In the clockwise direction, the counter increments until it saturates at <b>Count Limit or Reset Value</b>. In the counterclockwise direction, the counter decrements until it saturates at 0.</p> <p>You can use this setting to set a repeatable 0 when there is a mechanical stop. At model start, the count is initialized to 0. The machine then shifts to the negative direction stop. At that point, the encoder reports 0 at the stop and all other positions will be positive and repeatable.</p> |
| Non-recycle          | <p>Upon model start, the counter is initialized to <b>Count Limit or Reset Value</b>. With counterclockwise rotation, the counter decrements and saturates at 0. If the encoder reaches the index before the counter saturates at 0, the counter resets to <b>Count Limit or Reset Value</b>. With clockwise rotation, the counter increments until the encoder reaches the index. When the encoder reaches the index, the counter resets to <b>Count Limit or Reset Value</b>. You can use this setting to place 0 at the first index inside a mechanical limit.</p> | <p>The behavior of this option is undefined.</p>                                                                                                                                                                                                                                                                                                                                                                                                                                                                                                                 |

| Counting Mode | Index input resets counter Selected       | Index input resets counter Deselected                                                                                                                                                                                                                                                                                                                                                                                                                  |
|---------------|-------------------------------------------|--------------------------------------------------------------------------------------------------------------------------------------------------------------------------------------------------------------------------------------------------------------------------------------------------------------------------------------------------------------------------------------------------------------------------------------------------------|
| Modulo-N      | The behavior of this option is undefined. | Upon model start, the counter is initialized to 0. In the clockwise direction, the counter increments to <b>Count Limit or Reset Value</b> , then resets to 0 and repeats. When the counter decrements, it counts to 0, then resets to the <b>Count Limit or Reset Value</b> value and continues to decrement. You can use this setting to repeat intervals that do not match the distance between indexes (resulting, for example, from gear ratios). |

**Count Limit or Reset Value** — The preset register (PR) on the counter chip is a 24-bit quantity. The counter uses this value as a limit for the **Range Limit**, **Non-recycle**, and **Modulo-N** counting modes.

When **Index input resets counter** is selected, this value acts as both the initial value at model start and the value that an index resets the count to.

You can enter negative limit values, but the counter treats them as large positive values. For example, a limit of -1 results in the **Modulo-N** range from 0 to  $2^{24} - 1$ , not from -1 to 0.

**Count Range** — From the list, choose  $0 \dots 2^{24}-1$  or  $-2^{23} \dots +2^{23}-1$ . The counter uses a 24-bit accumulator which overflows from  $2^{24} - 1$  to 0. This same overflow can be interpreted as the transition from -1 to 0. Selecting the unipolar range  $0$  to  $2^{24} - 1$  puts the discontinuity in counts at 0. Selecting the bipolar range of  $(-2)^{23}$  to  $2^{23} - 1$  puts the discontinuity far away from 0. The bipolar range is achieved by sign extending the 24-bit count to 32 bits before converting to double.

**Count Speed** — From the list, choose non-quadrature, 1X, 2X, or 4X:

- non-quadrature — Counts the rising edges of the A input, losing direction information in the process. The presence of a quadrature signal on the B input might cause undefined results. You should disconnect the B and index inputs.
- 1X — Counts up or down once per complete cycle of the quadrature signal.
- 2X — Counts up or down twice per complete cycle of the quadrature signal.
- 4X — Counts up or down four times per complete cycle of the quadrature signal.

**Filter prescale factor** — Enter a base prescale factor for digital filtering. This filter helps eliminate high frequency noise. Enter a value from 0 to ff in hexadecimal (0 to 256 in decimal). For example, for a prescale factor value of ff in hexadecimal, enter

```
0xff
```

**Sample time** — Enter a base sample time or a multiple of the base sample time. The sample time indicates the update rate of registration on the input (Duty Cycle). Enter -1 to inherit the model sample time from another block. The sample time is in seconds.

**PCI Slot (-1:autosearch)** — If only one board of this type is physically present in the target PC, enter

```
-1
```

to automatically locate the board.

If two or more boards of this type are physically present in the target PC, enter the bus number and the PCI slot number of the board associated with this driver block. Use the format [BusNumber, SlotNumber]. To determine the bus number and the PCI slot number, type

```
getxpcpci
```

## PCI-QUAD04 Incremental Encoder (Obsolete)

This driver block has three block outputs: **Angle**, **Turns**, and **Init**.

You can use **Init** to determine when the block output values are valid. **Init** is first set to 0. When the encoder reached the first index, **Init** is set to 1. From then on, you can determine the exact position, direction, and velocity. **Init**

remains 1 unless **Counting reset by index** is set to Only First, and the counter detects a rollover. For more information, see “Driver Block Parameters” on page 21-107.

**Turns** is the number of complete revolutions made by the encoder. **Angle** is the amount the encoder turns since the last full revolution.

The distance is given by:

$$\text{distance} = 2 * \text{pi} * \text{Turns} + \text{Angle}$$

The velocity is given by:

$$\text{velocity} = (\text{distance}(t_s) - \text{distance}(t_s-1)) / t_s$$

The direction is given by:

$$\text{direction} = \text{distance}(t_s) - \text{distance}(t_s-1)$$

A negative value is reverse, while a positive value is forward.

### Driver Block Parameters

**Function module** — From the list choose 1, 2, 3, or 4. This parameter specifies which channel you use for this block. For the same board (same base address) two blocks cannot have the same channel number.

**Counting reset by index** — From the list choose Only First, Continuous, or Index input disabled.

If you choose Only First, the first time the encoder reaches the index, the counter is reset to zero, the **Init** output signal is set to 1, and the encoder begins to count. The encoder ignores all other times it reaches the index. **Init** remains 1 until a rollover is detected, and then set to -1. A rollover is when the counter reaches its maximum value and begins to start counting at zero again. A rollover can also occur when the counter reaches its minimum value and the counter resets itself to the maximum value and resumes counting down. The outputs are still accurate after rollover. The -1 flag is used to alert that a rollover has occurred.

If you choose Continuous, The first time the encoder reaches the index, the counter is reset to zero, the **Init** output signal is set to 1, and the encoder begins to count. Each time the encoder reaches the index, it resets to zero. **Init** remains always at 1 because a rollover cannot occur.

**Positive Rotation** — From the list, choose either `Clockwise` or `Counter Clockwise`. This parameter sets the direction for positive rotation. If you choose `Clockwise`, when the encoder is turned clockwise it counts up, and when turned counter clockwise it counts down. If you choose `Counter Clockwise`, the counting direction is reversed.

**Mode** — From the list, choose `Single`, `Double`, or `Quadruple`. This parameter specifies the phase detection mode. That is, how many phase changes are detected. For more information, see the board manual.

**Resolution** — This field specifies the divisions of the connected incremental encoder for one revolution.

**Filter prescale factor** — Enter a base prescale factor for digital filtering. This filter helps eliminate high frequency noise. Enter a value from 0 to `ff` in hexadecimal (0 to 256 in decimal). For example, for a prescale factor value of `ff` in hexadecimal, enter

`0xff`

**Sample time** — Enter a base sample time or a multiple of the base sample time. The sample time indicates the update rate of registration on the input (Duty Cycle). Enter `-1` to inherit the model sample time from another block. The sample time is in seconds.

**PCI Slot (-1:autosearch)** — If only one board of this type is physically present in the target PC, enter

`-1`

to automatically locate the board.

## PCI-DAS-TC

The PCI-DAS-TC is an I/O board with 16 differential analog thermocouple input channels. The thermocouple signals are converted by a high frequency synchronous V-F A/D converter. The board is equipped with its own micro-controller responsible for calibration, cold junction compensation, moving average calculations, conversion, and conversion into physical engineering units. The on-board micro-controller significantly off loads the main CPU.

xPC Target supports this board with this driver block:

- “PCI-DAS-TC Thermocouple” on page 21-255

### Board Characteristics

|                                 |                 |
|---------------------------------|-----------------|
| Board name                      | PCI-DAS-TC      |
| Manufacturer                    | Computer Boards |
| Bus type                        | PCI             |
| Access method                   | I/O mapped      |
| Multiple block instance support | No              |
| Multiple board support          | Yes             |



## PCI-DAS-TC Thermocouple

### Scaling Input to Output

| Hardware Input | Block Input Data Type | Scaling                                   |
|----------------|-----------------------|-------------------------------------------|
| Volts          | Double                | temperature in either degrees C, K, or F. |

### Driver Block Parameters

**Conversion rate (interrogation time)** — From the list, choose either 50Hz, 60Hz, or 400 Hz. This is the conversion rate for the V-F A/D converter. The conversion rate is the same for all input channels.

**Number of samples for moving average** — From the list, choose a value from 1 to 16. Converted signal values are put into a cyclic buffer of size **n** which is used to calculate the moving average over these **n** samples.

**Number of channels to be acquired (1..n)** — From the list, choose a value from 1 to 16. This is the number of input channels activated for conversion. The first channel of the scan is always and input channel with the number 1 and the last channel has the number **n**.

**Vector input thermocouple types (cell array of char)** — For each acquired channel, enter a valid type of either 'J', 'K', 'E', 'T', 'R', 'S', or 'B'. This vector defines the type of thermocouple for each channel. The vector must be the same length as the **Number of channels to be acquired**.

**Vector of input gains (double array)** — For each acquired channel, enter a valid input gain of either 1, 125, 166.7, or 400. This vector defines the input gain for each channel. The vector must be the same length as the **Number of channels to be acquired**.

**Vector or temperature formats (cell array of char)** — For each acquired channel, enter a valid format of either 'C' or 'F'. 'C' = Celsius and 'F' = Fahrenheit. The vector must be the same length as the **Number of channels to be acquired**.

**Read and output CJC temperature** — If you want the block to read, convert, and output the temperature of the cold junction (CJC) sensor on the board, select this check box. If selected, the block shows an additional output port with the value of the CJC temperature.

**Sample time** — Enter a base sample time or a multiple of the base sample time.

**PCI Slot (-1:autosearch)** — If only one board of this type is physically present in the target PC, enter

-1

to automatically locate the board.

If two or more boards of this type are physically present in the target PC, enter the bus number and the PCI slot number of the board associated with this driver block. Use the format [BusNumber, SlotNumber]. To determine the bus number and the PCI slot number, type

```
getxpcpci
```

---

**Note** Each time a target application containing this driver block is downloaded to the target PC, the board automatically does a full calibration. Thermocouple sensor calibration is an extensive procedure and because it has to take place for each channel independently, the calibration time can easily exceed several seconds, especially when the number of channels to be acquired is 5 or higher.

Because of this long calibration period during the initialization stage of the target application, the download procedure can time-out and return an error message. To avoid this error, increase the default timeout duration. See “Increasing the Time-Out Value” on page 3-49.

---

# National Instruments

---

This chapter I/O boards supported by xPC Target (<http://www.ni.com>).

|                                                    |                                                                                                                                                                  |
|----------------------------------------------------|------------------------------------------------------------------------------------------------------------------------------------------------------------------|
| AT-AO-6 (p. 22-4)                                  | I/O board with 6 analog output (D/A) channels, and 16 digital I/O lines.                                                                                         |
| AT-AO-10 (p. 22-6)                                 | I/O board with 10 analog output (D/A) channels, and 16 digital I/O lines.                                                                                        |
| PC-DIO-24 (p. 22-8)                                | I/O board with 24 digital input and output lines.                                                                                                                |
| PC-TIO-10 (p. 22-12)                               | I/O board with 16 digital input and output lines, and 10 counter/timer channels.                                                                                 |
| PCI-6023E (p. 22-23)                               | I/O board with 16 single or 8 differential analog input (A/D) channels, 8 digital I/O lines, and 2 counter/timers.                                               |
| PCI-6024E (p. 22-31)                               | I/O board with 16 single or 8 differential analog input (A/D) channels, 2 analog output (D/A) channels, 8 digital input and output lines, and 2 counter/timers.  |
| PCI-6025E (p. 22-40)                               | I/O board with 16 single or 8 differential analog inputs (A/D) channels, 2 analog output channels, 32 digital input and output lines, and 2 counter/timers.      |
| PCI-6030E (Formerly<br>PCI-MIO-16XE-10) (p. 22-49) | I/O board with 16 single or 8 differential analog input (A/D) channels, 2 analog output (D/A) channels, 8 digital input and output lines, and 2 counter/timers.  |
| PCI-6031E (p. 22-59)                               | I/O board with 64 single or 32 differential analog input (A/D) channels, 2 analog output (D/A) channels, 8 digital input and output lines, and 2 counter/timers. |
| PCI-6040E (Formerly PCI-MIO-16E-4)<br>(p. 22-69)   | I/O board with 16 single or 8 differential analog input channels, 2 analog output channels, 8 digital input and output lines, and 2 counter/timers.              |

|                                               |                                                                                                                                                                 |
|-----------------------------------------------|-----------------------------------------------------------------------------------------------------------------------------------------------------------------|
| PCI/PXI-6052E (p. 22-79)                      | I/O board with 16 single or 8 differential analog input channels, 2 analog output channels and 8 digital input and output lines.                                |
| PCI-6070E (Formerly PCI-MIO-16E-1) (p. 22-89) | I/O board with 16 single or 8 differential analog input channels, 2 analog output channels, 8 digital input and output lines, and 2 counter/timers.             |
| PCI-6071E (p. 22-99)                          | I/O board with 64 single or 8 differential analog input (A/D) channels, 2 analog output (D/A) channels, 8 digital input and output lines, and 2 counter/timers. |
| PCI-6503 (p. 22-109)                          | I/O board with 24 digital input and output lines.                                                                                                               |
| PCI-6527 (p. 22-113)                          | I/O board with 24 filtered digital input lines and 24 digital output lines. You can individually turn input filtering on or off for each of the 24 input lines. |
| PCI-6601 (p. 22-117)                          | General purpose counter/timer board. It has four 32-bit counter channels.                                                                                       |
| PCI/PXI-6602 (p. 22-125)                      | General purpose counter/timer board. It has eight 32-bit counter channels.                                                                                      |
| PCI-6703 (p. 22-134)                          | I/O board with 16 voltage outputs and 8 digital I/O lines.                                                                                                      |
| PCI-6704 (p. 22-136)                          | I/O board with 16 voltage outputs, 16 current outputs, and 8 digital I/O lines.                                                                                 |
| PCI-6711 (p. 22-138)                          | I/O board with 8 analog output (D/A) channels and 8 digital input and output lines.                                                                             |
| PCI/PXI-6713 (p. 22-143)                      | I/O board with 4 analog output (D/A) channels and 8 digital input and output lines.                                                                             |
| PCI-DIO-96 (p. 22-148)                        | I/O board with 96 digital input and output lines.                                                                                                               |
| PXI-6040E (p. 22-152)                         | I/O board with 16 single or 8 differential analog input channels, 2 analog output channels, 8 digital input and output lines, and 2 counter/timers.             |
| PXI-6070E (p. 22-162)                         | I/O board with 16 single or 8 differential analog input channels, 2 analog output channels, 8 digital input and output lines, and 2 counter/timers.             |

---

PXI-6071E (p. 22-171)

I/O board with 64 single or 8 differential analog input (A/D) channels, 2 analog output (D/A) channels, 8 digital input and output lines, and 2 counter/timers.

PXI-6508 (p. 22-181)

I/O board with 96 digital input and output lines.

PXI-6527 (p. 22-185)

I/O board with 24 filtered digital input lines and 24 digital output lines. You can individually turn input filtering on or off for each of the 24 input lines.

PXI-6704 (p. 22-189)

I/O board with 16 voltage outputs, 16 current outputs, and 8 digital I/O lines.

## AT-AO-6

The AT-AO-6 is an I/O board with 6 analog output (D/A) channels (12-bit), and 16 digital I/O lines.

xPC Target supports this board with this driver block:

- “AT-AO-6 Analog Output (D/A)” on page 22-4

### Board Characteristics

|                                 |                      |
|---------------------------------|----------------------|
| Board name                      | AT-AO-6              |
| Manufacturer                    | National Instruments |
| Bus type                        | ISA                  |
| Access method                   | I/O mapped           |
| Multiple block instance support | Yes                  |
| Multiple board support          | Yes                  |

## AT-AO-6 Analog Output (D/A)

### Scaling Input to Output

| Hardware Output | Block Input Data Type | Scaling |
|-----------------|-----------------------|---------|
| volts           | Double                | 1       |

### Driver Block Parameters

**Channel vector** — Enter numbers between 1 and 6. This driver allows the selection of individual D/A channels in any order. The number of elements defines the number of D/A channels used. For example, to use the first and second analog output (D/A) channels, enter

[1,2]

Number the channels beginning with 1 even if the board manufacturer starts numbering the channels with 0.

**Range vector** — Enter a range code for each of the channels in the channel vector. The range vector must be the same length as the channel vector. This board allows the range of each channel to be different.

The following table is a list of the ranges for this driver and the corresponding range codes.

| Input Range (V) | Range Code | Input Range (V) | Range Code |
|-----------------|------------|-----------------|------------|
| -10 to +10      | -10        | 0 to 10         | 10         |

For example, if the first channel is -10 to +10 volts, and the second channel is 0 to 10 volts, enter

[ -10,10]

The range settings have to correspond to the jumper settings on the board.

**Reset vector** — The reset vector controls the behavior of the channel at model termination. Enter a scalar or a vector that is the same length as the channel vector. If you specify a scalar value, that setting is used for all channels. If you specify a value of 1, the corresponding channel is reset to the value specified in the initial value vector. If you specify a value of 0, the channel remains at the last value attained while the model was running.

**Initial value vector** — The initial value vector contains the initial voltage values for the output channels. Enter a scalar or a vector that is the same length as the channel vector. If you specify a scalar value, that value is the initial value for all channels. The channels are set to the initial values between the time the model is downloaded and the time it is started.

**Sample time** — Base sample time or a multiple of the base sample time.

**Base address** — Enter the base address of the board. It is important that this entry corresponds to the DIP-switch settings on the board. For example, if the base address is 300 (hexadecimal), enter

0x300

numbering the lines with 0.

## AT-AO-10

The AT-AO-10 is an I/O board with 10 analog output (D/A) channels (12-bit), and 16 digital I/O lines.

xPC Target supports this board with this driver block:

- “AT-AO-10 Analog Output (D/A)” on page 22-6

### Board Characteristics

|                                 |                      |
|---------------------------------|----------------------|
| Board name                      | AT-AO-10             |
| Manufacturer                    | National Instruments |
| Bus type                        | ISA                  |
| Access method                   | I/O mapped           |
| Multiple block instance support | Yes                  |
| Multiple board support          | Yes                  |

## AT-AO-10 Analog Output (D/A)

### Scaling Input to Output

| Hardware Output | Block Input Data Type | Scaling |
|-----------------|-----------------------|---------|
| volts           | Double                | 1       |

### Driver Block Parameters

**Channel vector** — Enter numbers between 1 and 10. This driver allows the selection of individual D/A channels in any order. The number of elements defines the number of D/A channels used. For example, to use the first and second analog output (D/A) channels, enter

[1,2]

Number the channels beginning with 1 even if the board manufacturer starts numbering the channels with 0.



**Range vector** — Enter a range code for each of the channels in the channel vector. The range vector must be the same length as the channel vector. This board allows the range of each channel to be different.

The following table is a list of the ranges for this driver and the corresponding range codes.

| Input range (V) | Range code | Input range (V) | Range code |
|-----------------|------------|-----------------|------------|
| -10 to +10      | -10        | 0 to 10         | 10         |

For example, if the first channel is -10 to +10 volts, and the second channel is 0 to 10volts, enter

[ -10,10]

The range settings have to correspond to the jumper settings on the board.

**Reset vector** — The reset vector controls the behavior of the channel at model termination. Enter a scalar or a vector that is the same length as the channel vector. If you specify a scalar value, that setting is used for all channels. If you specify a value of 1, the corresponding channel is reset to the value specified in the initial value vector. If you specify a value of 0, the channel remains at the last value attained while the model was running.

**Initial value vector** — The initial value vector contains the initial voltage values for the output channels. Enter a scalar or a vector that is the same length as the channel vector. If you specify a scalar value, that value is the initial value for all channels. The channels are set to the initial values between the time the model is downloaded and the time it is started.

**Sample time** — Base sample time or a multiple of the base sample time.

**Base address** — Enter the base address of the board. It is important that this entry corresponds to the DIP-switch settings on the board. For example, if the base address is 300 (hexadecimal), enter

0x300

## PC-DIO-24

The PC-DIO-24 is an I/O board with 24 digital input and output lines. xPC Target supports this board with these driver blocks:

- “PC-DIO-24 Digital Input” on page 22-8
- “PC-DIO-24 Digital Output” on page 22-9

### Board Characteristics

|                                 |                      |
|---------------------------------|----------------------|
| Board name                      | PC-DIO-24            |
| Manufacturer                    | National Instruments |
| Bus type                        | ISA                  |
| Access method                   | I/O-mapped           |
| Multiple block instance support | Yes                  |
| Multiple board support          | Yes                  |

### PC-DIO-24 Digital Input

The PC-DIO24 has one 8255 chip with 3 ports (A,B,C). Each port has a maximum of 8 digital I/O lines that can be configured as inputs or outputs.

Use a separate driver block for each port. By selecting the digital input driver block, the port is configured as input.

### Scaling Input to Output

| Hardware Input | Block Output Data Type | Scaling                         |
|----------------|------------------------|---------------------------------|
| TTL            | Double                 | TTL low = 0.0<br>TTL high = 1.0 |

## Driver Block Parameters

**Channel vector** — Enter numbers between 1 and 8 to select the digital input lines used with this port. This driver allows the selection of individual digital input lines in any order. The number of elements defines the number of digital lines used.

For example, to use all of the digital inputs for one port, enter

```
[1,2,3,4,5,6,7,8]
```

Number the lines beginning with 1 even if the board manufacturer starts numbering the lines with 0.

**Port** — From the list choose either A, B, or C. The I/O board has a 8255 chip with 3 ports. The **Port** parameter defines which port of the 8255 chip is used for this driver block. Each port has a maximum of 8 digital lines that can be configured as inputs or outputs depending on which driver block is chosen. In each case, one block is needed for each port.

**Sample time** — Enter a base sample time or a multiple of the base sample time.

**Base address** — Enter the base address of the board. This entry must correspond to the DIP-switch settings on the board. For example, if the base address is 300 (hexadecimal), enter

```
0x300
```

## PC-DIO-24 Digital Output

The PC-DIO24 has one 8255 chip with 3 ports (A,B,C). Each port has a maximum of 8 digital I/O lines that can be configured as inputs or outputs.

Use a separate driver block for each port. By selecting the digital output driver block, the port is configured as output.

## Scaling Input to Output

| Hardware Output | Block Input Data Type | Scaling                             |
|-----------------|-----------------------|-------------------------------------|
| TTL             | Double                | < 0.5 = TTL low<br>≥ 0.5 = TTL high |

### Driver Block Parameters

**Channel vector** — Enter numbers between 1 and 8 to select the digital output lines used with this port. This driver allows the selection of individual digital output lines in any order. The number of elements defines the number of digital lines used.

For example, to use all of the digital outputs for one port, enter

```
[1,2,3,4,5,6,7,8]
```

Number the lines beginning with 1 even if the board manufacturer starts numbering the lines with 0.

**Port** — From the list choose either A, B, or C. The I/O board has a 8255 chip with 3 ports. The **Port** parameter defines which port of the 8255 chip is used for this driver block. Each port has a maximum of 8 digital lines that can be configured as inputs or outputs depending on which driver block is chosen. In each case, one block is needed for each port.

**Reset vector** — The reset vector controls the behavior of the channel at model termination. Enter a scalar or a vector that is the same length as the channel vector. If you specify a scalar value, that setting is used for all channels. If you specify a value of 1, the corresponding channel is reset to the value specified in the initial value vector. If you specify a value of 0, the channel remains at the last value attained while the model was running.

**Initial value vector** — The initial value vector contains the initial values (0 or 1) of the output channels. Enter a scalar or a vector that is the same length as the channel vector. If you enter a scalar, that value is used for all channels. The channels are set to these initial values between the time the model is downloaded and the time it is started.

**Sample time** — Enter a base sample time or a multiple of the base sample time.

**Base address** — Enter the base address of the board. This entry must correspond to the DIP-switch settings on the board. For example, if the base address is 300 (hexadecimal), enter

0x300

## PC-TIO-10

The PC-TIO-10 is an I/O board with 16 digital input and output lines, and 10 counter/timer channels (16-bit).

xPC Target supports this board with these driver blocks:

- “PC-TIO-10 Digital Input” on page 22-12
- “PC-TIO-10 Digital Output” on page 22-13
- “PC-TIO-10 Counter PWM” on page 22-15
- “PC-TIO-10 Counter PWM & ARM” on page 22-16
- “PC-TIO-10 Counter FM” on page 22-17
- “PC-TIO10 Counter FM & ARM” on page 22-19
- “PC-TIO10 PWM Capture” on page 22-21
- “PC-TIO10 FM Capture” on page 22-22

### Board Characteristics

|                                 |                      |
|---------------------------------|----------------------|
| Board Name                      | PC-TIO10             |
| Manufacturer                    | National Instruments |
| Bus type                        | ISA                  |
| Access method                   | I/O mapped           |
| Multiple block instance support | Yes                  |
| Multiple board support          | Yes                  |

### PC-TIO-10 Digital Input

The PC-TIO-10 has one MC6821 chip with 2 ports (PIA A, PIA B). Each port has a maximum of 8 digital I/O lines that can be configured as inputs or outputs.

Use a separate driver block for each port. By selecting the digital input driver block, the port is configured as input.

## Scaling Input to Output

| Hardware Input | Block Output Data Type | Scaling                         |
|----------------|------------------------|---------------------------------|
| TTL            | Double                 | TTL low = 0.0<br>TTL high = 1.0 |

### Driver Block Parameters

**Number of channels** — Enter the number of digital input channels (from 1 to 8) to use with the port specified in **Port**.

**Port** — From the list choose either PIA A, or PCA B. The I/O board has a MC6821 chip with 2 ports. The **Port** parameter defines which port of the MC6821 chip is used for this driver block. Each port has a maximum of 8 digital lines that can be configured as inputs or outputs depending on which driver block is chosen. In each case, one block is needed for each port.

**Sample time** — Enter a base sample time or a multiple of the base sample time.

**Base address** — Enter the base address of the board. This entry must correspond to the DIP-switch settings on the board. For example, if the base address is 300 (hexadecimal), enter

0x300

## PC-TIO-10 Digital Output

The PC-TIO-10 has one MC6821 chip with 2 ports (PIA A, PIA B). Each port has a maximum of 8 digital I/O lines that can be configured as inputs or outputs.

Use a separate driver block for each port. By selecting the digital output driver block, the port is configured as output.

## Scaling Input to Output

| Hardware Output | Block Input Data Type | Scaling                             |
|-----------------|-----------------------|-------------------------------------|
| TTL             | Double                | < 0.5 = TTL low<br>≥ 0.5 = TTL high |

### Driver Block Parameters

**Number of channels** — Enter the number of digital output channels (from 1 to 8) to use with the port specified in **Port**.

**Port** — From the list choose either PIA A, or PCA B. The I/O board has a MC6821 chip with 2 ports. The **Port** parameter defines which port of the MC6821 chip is used for this driver block. Each port has a maximum of 8 digital lines that can be configured as inputs or outputs depending on which driver block is chosen. In each case, one block is needed for each port.

**Sample time** — Enter the base sample time or a multiple of the base sample time.

**Base address** — Enter the base address of the board. This entry must correspond to the DIP-switch settings on the board. For example, if the base address is 300 (hexadecimal), enter

0x300



## PC-TIO-10 Counter PWM

The PC-TIO-10 has two AM9513A chips each with 5 counters for a total of 10 counters on the board.

The PC-TIO-10 PWM driver programs the AM9513A for PWM (Pulse Width Modulation) signal generation (a square wave with fixed frequency and variable duty cycle). The block has one input which defines the variable duty cycle between 0 and 1. For the corresponding counter channel, the PWM signal is output at the pin named OUT.

### Scaling Input to Output

| Hardware Input | Block Output Data Type | Scaling |
|----------------|------------------------|---------|
| TTL            | Double                 | 0 to 1  |

### Driver Block Parameters

**Counter** — From the list, choose 1, 2, 3, 4, 5, 6, 7, 8, 9, or 10 to select which counter is used with this driver block. In each case, one block is needed for each counter.

**Frequency base** — From the list, choose F1=1MHz, F2=100kHz, F3=10kHz, F4=1kHz, or F5=100Hz to set the base frequency.

**Relative output frequency** — Enter a value less than 1. The **Relative output frequency** is multiplied by the **Frequency base** to set the fixed output frequency of the PWM-signal.

For example, if the output frequency of a square wave has to be 17.5 kHz, then choose F2=100kHz as the Frequency base and enter 0.175 as the **Relative output frequency**.  $100\text{kHz} \times 0.175 = 17.5\text{ kHz}$

**Level sequence of square wave** — From the list, choose either high-low or low-high:

- If you choose high-low, the square wave period starts with the TTL high part followed by the TTL low part.
- If you choose low-high, the square wave period starts with the TTL low part followed by the TTL high part.

In either case, the duty cycle entering the block defines the duration of the TTL high part.

**Level when disarmed** — From the list, choose either high or low. The counter is automatically disarmed when the target application is not running and gets armed when the application begins running. This parameter sets the TTL level when the counter is disarmed.

**Sample time** — Enter the base sample time or a multiple of the base sample time. The sample time indicates the update rate of registration on the input (Duty Cycle)

**Base address** — Enter the base address of the board. This entry must corresponds to the DIP-switch settings on the board. For example, if the base address is 300 (hexadecimal), enter

0x300

## PC-TIO-10 Counter PWM & ARM

The PC-TIO-10 has two AM9513A chips each with 5 counters for a total of 10 counters on the board.

The PC-TIO-10 PWM & ARM driver programs the AM9513A for PWM or disarmed signal generation (a square wave with fixed frequency and variable duty cycle). Additionally the driver allows to arm and disarm the counter by the second block input. For the corresponding counter channel, the PWM signal is output at the pin named OUT.

### Scaling Input to Output

| Hardware Input | Block Output Data Type            | Scaling                               |
|----------------|-----------------------------------|---------------------------------------|
| TTL            | Duty cycle: Double<br>Arm: Double | 0 to 1<br><0.5 disarmed<br>≥0.5 armed |

### Driver Block Parameters

**Counter** — From the list, choose 1, 2, 3, 4, 5, 6, 7, 8, 9, or 10 to select which counter is used with this driver block. In each case, one block is needed for each counter.

**Frequency base** — From the list, choose F1=1MHz, F2=100kHz, F3=10kHz, F4=1kHz, or F5=100Hz to set the base frequency.

**Relative output frequency** — Enter a value less than 1. The **Relative output frequency** is multiplied by the **Frequency base** to set the fixed output frequency of the PWM-signal.

For example, if the output frequency of a square wave has to be 17.5 kHz, then choose F2=100kHz as the **Frequency base** and enter 0.175 as the **Relative output frequency**.  $100\text{kHz} \times 0.175 = 17.5 \text{ kHz}$

**Level sequence of square wave** — From the list, choose either high-low or low-high:

- If you choose high-low, the square wave period starts with the TTL high part followed by the TTL low part.
- If you choose low-high, the square wave period starts with the TTL low part followed by the TTL high part.

In either case, the duty cycle entering the block defines the duration of the TTL high part.

**Level when disarmed** — From the list, choose either high or low. The counter is automatically disarmed when the target application is not running. If the application is running, the second input port controls whether the counter is armed or disarmed. This parameter sets the TTL level when the counter is disarmed.

**Sample time** — Enter the base sample time or a multiple of the base sample time. The sample time indicates the update rate of registration on the input (Duty Cycle)

**Base address** — Enter the base address of the board. This entry must correspond to the DIP-switch settings on the board. For example, if the base address is 300 (hexadecimal), enter

0x300

## PC-TIO-10 Counter FM

The PC-TIO-10 has two AM9513A chips each with 5 counters for a total of 10 counters on the board.

The PC-TIO-10 FM driver programs the AM9513A for FM (Frequency Modulation) signal generation (a square wave with fixed duty cycle and variable frequency). For the corresponding counter channel, the PWM signal is output at the pin named OUT.

**Scaling Input to Output**

| Hardware Input | Block Output Data Type | Scaling |
|----------------|------------------------|---------|
| TTL            | Double                 | 0 to 1  |

**Driver Block Parameters**

**Counter** — From the list, choose 1, 2, 3, 4, 5, 6, 7, 8, 9, or 10 to select which counter is used with this driver block. In each case, one block is needed for each counter.

**Frequency base** — From the list, choose F1=1MHz, F2=100kHz, F3=10kHz, F4=1kHz, or F5=100Hz to set the base frequency.

**Output duty Cycle** — Enter a value between 0 and 1 to set the duty cycle of the square wave. The Duty Cycle is held fixed during execution of the target application.

---

**Note** Your control over the output duty cycle is not always precise. See “PWM and FM Driver Block Notes” on page 1-8 for details.

---

**Level sequence of square wave** — From the list, choose either high-low or low-high:

- If you choose high-low, the square wave period starts with the TTL high part followed by the TTL low part.
- If you choose low-high, the square wave period starts with the TTL low part followed by the TTL high part.

In either case, the duty cycle entering the block defines the duration of the TTL high part.

**Level when disarmed** — From the list, choose either high or low. The counter is automatically disarmed when the target application is not running and gets armed when the application begins running. This parameter sets the TTL level when the counter is disarmed.

**Sample time** — Enter the base sample time or a multiple of the base sample time. The sample time indicates the update rate of registration on the input (Duty Cycle)

**Base address** — Enter the base address of the board. This entry must correspond to the DIP-switch settings on the board. For example, if the base address is 300 (hexadecimal), enter

0x300

## PC-TIO10 Counter FM & ARM

The PC-TIO-10 has two AM9513A chips each with 5 counters for a total of 10 counters on the board.

The PC-TIO-10 FM & ARM driver programs the AM9513A for FM (Frequency Modulation) signal generation (a square wave with fixed duty cycle and variable frequency). Additionally the driver allows to arm and disarm the counter by the second block input. For the corresponding counter channel, the PWM signal is output at the pin named OUT.

### Scaling of Input to Output

| Hardware Input | Block Output Data Type                    | Scaling                     |
|----------------|-------------------------------------------|-----------------------------|
| TTL            | Variable frequency: Double<br>Arm: Double | <0.5 disarmed<br>≥0.5 armed |

### Driver Block Parameters

**Counter** — From the list, choose 1, 2, 3, 4, 5, 6, 7, 8, 9, or 10 to select which counter is used with this driver block. In each case, one block is needed for each counter.

**Frequency base** — From the list, choose F1=1MHz, F2=100kHz, F3=10kHz, F4=1kHz, or F5=100Hz to set the base frequency.

**Output duty Cycle** — Enter a value between 0 and 1 to set the duty cycle of the square wave. The Duty Cycle is held fixed during execution of the target application.

---

**Note** Your control over the output duty cycle is not always precise. See “PWM and FM Driver Block Notes” on page 1-8 for details.

---

**Level sequence of square wave** — From the list, choose either high-low or low-high:

- If you choose high-low, the square wave period starts with the TTL high part followed by the TTL low part.
- If you choose low-high, the square wave period starts with the TTL low part followed by the TTL high part.

In either case, the **Output duty cycle** defined in the setting above define the duration of the TTL high part.

**Level when disarmed** — From the list, choose either high or low. The counter is automatically disarmed when the target application is not running. If the application is running, the second input port controls whether the counter is armed or disarmed. This parameter sets the TTL level when the counter is disarmed. If a value 1 is asserted, the counter gets armed.

**Sample time** — Enter the base sample time or a multiple of the base sample time. The sample time indicates the update rate of registration on the input (Duty Cycle)

**Base address** — Enter the base address of the board. This entry must corresponds to the DIP-switch settings on the board. For example, if the base address is 300 (hexadecimal), enter

0x300

The dialogue box of the block allows the following settings:

## PC-TIO10 PWM Capture

This block programs the AMD9513A for capturing PWM signals by using two counters. One counter measures the cycle duration, and the other counter measures the duration the signal is high.

There are two outputs. One output is the relative frequency compared to the base frequency. The other output is the duty cycle. To get the actual frequency, multiply the base frequency by the relative frequency.

The PWM signal has to enter the pins named GATE of both corresponding counter channels (parallel wiring). Both CLK pins have to be left unconnected.

### Scaling Input to Output

| Hardware Output | Block Input Data Type | Scaling |
|-----------------|-----------------------|---------|
| TTL             | Double                | 0 to 1  |

### Driver Block Parameters

**Counter** — From the list, choose 1&2, 2&3, 3&4, 4&5, 6&7, 7&8, 8&9, 9&10. This selects which two counters the driver block uses to determine the PWM. Use one block for each pair of counters. No two blocks should use the same counter. For example, use counters 1&2 for one block and 3&4 for a second block. Do not use a combination like 1&2 and 2&3.

**Frequency base** — From the list, choose F1=1MHz, F2=100kHz, F3=10kHz, F4=1kHz, or F5=100Hz to set the base frequency. The XTAL frequency is assumed to be 1MHz, therefore the jumper on the CIO-CTR05 has to be in position 1MHz not 5MHz.

**Sample time** — Enter the base sample time or a multiple of the base sample time. The sample time indicates the update rate of registration on the input (Duty Cycle)

**Base address** — Enter the base address of the board. This entry must corresponds to the DIP-switch settings on the board. For example, if the base address is 300 (hexadecimal), enter

0x300

## PC-TIO10 FM Capture

This block programs the AMD9513A for capturing FM signals.

There is one output for relative frequency compared to the base frequency. To get the actual frequency, multiply the base frequency by the relative frequency.

The FM signal has to enter the pin named GATE of the corresponding counter channel. The CLK pin has to be left unconnected.

### Scaling Input to Output

| Hardware Output | Block Input Data Type | Scaling |
|-----------------|-----------------------|---------|
| TTL             | Double                | 0 to 1  |

### Driver Block Parameters

**Counter** — From the list, choose 1, 2, 3, 4, or 5. This selects which counter the driver block uses to determine the FM. In each case, one block is needed for each counter.

**Frequency base** — From the list, choose F1=1MHz, F2=100kHz, F3=10kHz, F4=1kHz, or F5=100Hz to set the base frequency. The XTAL frequency is assumed to be 1MHz, therefore the jumper on the CIO-CTR05 has to be in position 1MHz not 5MHz.

**Sample time** — Enter the base sample time or a multiple of the base sample time. The sample time indicates the update rate of registration on the input (Duty Cycle)

**Base address** — Enter the base address of the board. This entry must correspond to the DIP-switch settings on the board. For example, if the base address is 300 (hexadecimal), enter

0x300

## PC-TIO-10xx

You can use this block to program the AMD9513A counter. The PWM, PWM & ARM, FM, FM & ARM, PWM Capture, and FM Capture blocks use this block in their underlying subsystems. The API for this block is not currently documented.



## PCI-6023E

The PCI-6023E is an I/O board with 16 single or 8 differential analog input (A/D) channels (12-bit) with a maximum sample rate of 200 kHz, 8 digital I/O lines, and 2 counter/timers (24-bit) with a maximum source clock rate of 20 MHz.

xPC Target supports this board with these driver blocks:

- “PCI-6023E Analog Input (A/D)” on page 22-24
- “PCI-6023E Digital Input” on page 22-26
- “PCI-6023E Digital Output” on page 22-27
- “PCI-6023E Pulse Generation” on page 22-28
- “PCI-6023E Pulse Width/Period Measurement” on page 22-29

### Board Characteristics

|                                 |                                                                                                 |
|---------------------------------|-------------------------------------------------------------------------------------------------|
| Board name                      | PCI-6023E                                                                                       |
| Manufacturer                    | National Instruments                                                                            |
| Bus type                        | PCI                                                                                             |
| Access method                   | Memory mapped                                                                                   |
| Multiple block instance support | A/D: No, Digital I/O: Yes;<br>Period/Pulsewidth Measurement: Yes;<br>Pulsetrain Generation: No. |
| Multiple board support          | Yes                                                                                             |

## PCI-6023E Analog Input (A/D)

### Scaling Input to Output

| Hardware Input | Block Output Data Type | Scaling |
|----------------|------------------------|---------|
| volts          | Double                 | 1       |

### Driver Block Parameters

**Channel vector** — Enter numbers between 1 and 16. This driver allows you to enter channel numbers in any order.

For example, to use the first, second and fifth channels, enter

```
[ 1, 2, 5]
```

Number the channels beginning with 1 even if the board manufacturer starts numbering the channels with 0.

**Range vector** — Enter a range code for each of the channels in the channel vector. The range vector must be the same length as the channel vector. This driver allows each channel to be different.

The following table is a list of the ranges for this driver and the corresponding range codes.

| Input Range (V) | Range Code | Input Range (V) | Range Code |
|-----------------|------------|-----------------|------------|
| -10 to +10      | -10        | -0.5 to +0.5    | -0.5       |
| -5 to +5        | -5         | -0.05 to +0.05  | -0.05      |

For example, if the first channel is -10 to + 10 volts and the second and fifth channels are 0 to +1 volts, enter

```
[- 10, 1, 1]
```

**Input coupling vector** — Enter a coupling code for each of the channels in the channel vector. The coupling vector must be the same length as the channel vector. This driver allows a different coupling for each channel.

The following table is a list of the couplings for this driver and the corresponding coupling codes.

| <b>Coupling</b> | <b>Coupling Code</b> | <b>Description</b>                                                                                                                                                       |
|-----------------|----------------------|--------------------------------------------------------------------------------------------------------------------------------------------------------------------------|
| RSE             | 0                    | Analog input line connected to the positive input of the PGIA. Analog input ground (AIGND) internally connected to the negative input of the PGIA. See the board manual. |
| NRSE            | 1                    | Analog input line connected to the positive input of the PGIA. Analog input sense (AISENSE) connected to the negative input of the PGIA. See the board manual.           |
| DIFF            | 2                    | First analog input line connected to the positive input of the PGIA. Second analog input line connected to the negative input of the PGIA. See the board manual.         |

For example, if the first and second channels are single input and the fifth channel is a differential input, enter

[0,0,2]

The driver selects a second differential input 8 channels higher than the first channel. In the example above, the driver would select the thirteenth channel as a differential input with the fifth channel.

**Sample time** — Model base sample time or a multiple of the base sample time.

**PCI Slot (-1:autosearch)** — If only one board of this type is physically present in the target PC, enter

-1

to automatically locate the board.

If two or more boards of this type are physically present in the target PC, enter the bus number and the PCI slot number of the board associated with this driver block. Use the format [BusNumber, SlotNumber]. To determine the bus number and the PCI slot number, type

```
getxpcpci
```

## PCI-6023E Digital Input

### Scaling Input to Output

| Hardware Input | Block Output Data Type | Scaling                         |
|----------------|------------------------|---------------------------------|
| TTL            | Double                 | TTL low = 0.0<br>TTL high = 1.0 |

### Driver Block Parameters

**Channel vector** — Enter numbers between 1 and 8 to select the digital input lines used with this port. This driver allows the selection of individual digital input lines in any order. The number of elements defines the number of digital lines used.

For example, to use all of the digital inputs for one port, enter

```
[1,2,3,4,5,6,7,8]
```

Number the lines beginning with 1 even if the board manufacturer starts numbering the lines with 0.

**Sample time** — Enter a base sample time or a multiple of the base sample time.

**PCI Slot (-1:autosearch)** — If only one board of this type is physically present in the target PC, enter

-1

to automatically locate the board.

If two or more boards of this type are physically present in the target PC, enter the bus number and the PCI slot number of the board associated with this driver block. Use the format [BusNumber, SlotNumber]. To determine the bus number and the PCI slot number, type

```
getxpcpci
```

## PCI-6023E Digital Output

### Scaling Input to Output

| Hardware Output | Block Input Data Type | Scaling                             |
|-----------------|-----------------------|-------------------------------------|
| TTL             | Double                | < 0.5 = TTL low<br>≥ 0.5 = TTL high |

### Driver Block Parameters

**Channel vector** — Enter numbers between 1 and 8 to select the digital output lines used with this port. This driver allows the selection of individual digital output lines in any order. The number of elements defines the number of digital lines used.

For example, to use all of the digital outputs for one port, enter

```
[1,2,3,4,5,6,7,8]
```

Number the lines beginning with 1 even if the board manufacturer starts numbering the lines with 0.

**Reset vector** — The reset vector controls the behavior of the channel at model termination. Enter a scalar or a vector that is the same length as the channel vector. If you specify a scalar value, that setting is used for all channels. If you specify a value of 1, the corresponding channel is reset to the value specified in

the initial value vector. If you specify a value of 0, the channel remains at the last value attained while the model was running.

**Initial value vector** — The initial value vector contains the initial values (0 or 1) of the output channels. Enter a scalar or a vector that is the same length as the channel vector. If you enter a scalar, that value is used for all channels. The channels are set to these initial values between the time the model is downloaded and the time it is started.

**Sample time** — Enter a base sample time or a multiple of the base sample time.

**PCI Slot (-1:autosearch)** — If only one board of this type is physically present in the target PC, enter

-1

to automatically locate the board.

If two or more boards of this type are physically present in the target PC, enter the bus number and the PCI slot number of the board associated with this driver block. Use the format [BusNumber, SlotNumber]. To determine the bus number and the PCI slot number, type

```
getxpcpci
```

## PCI-6023E Pulse Generation

The inputs to the block should be a two element vector. The first element is the number of counts (of the 20 MHz source clock) that the counter should maintain at a low level, and the second element is the number of clock ticks for a high level. For example, to generate a pulsetrain at 1KHz with 25% low and 75% high, use the vector

```
[5000 15000]
```

### Driver Block Parameters

**Counter** — From the list, choose Counter 0, Counter 1, or Both to select the counter(s) to be used with this driver block. In each case, one block is needed for each physical board.

**Sample time** — Base sample time or a multiple of the base sample time.

**PCI slot (-1:autosearch)** — If only one board of this type is physically present in the target PC, enter

-1

to automatically locate the board.

If two or more boards of this type are physically present in the target PC, enter the bus number and the PCI slot number of the board associated with this driver block. Use the format [BusNumber, SlotNumber]. To determine the bus number and the PCI slot number, type

```
getxpcpci
```

## PCI-6023E Pulse Width/Period Measurement

### Driver Block Parameters

**Counter** — From the list, select a counter from 0 or 1.

**Trigger mode** — From the list, choose Level Triggered or Edge Triggered. See the table below for an example of how **Trigger mode** and **Polarity** affect one another. In this table, the data in the Output column is the result of a 1KHz pulse train with a 25% low and a 75% high pulse.

**Polarity** — From the list, choose Active low or Active high. See the table below for an example of how **Trigger mode** and **Polarity** affect one another. In this table, the data in the Output column resulted from a 1KHz pulse train with a 25% low and a 75% high pulse.

| Measurement objective    | Trigger mode    | Polarity    | Output |
|--------------------------|-----------------|-------------|--------|
| Pulse width (low pulse)  | Level Triggered | Active low  | 5000   |
| Pulse width (high pulse) | Level Triggered | Active High | 15000  |
| Period                   | Edge Triggered  | NA          | 20000  |

In every case, the output of the block is the number of clock ticks (of the 20MHz source clock) required for the specified measurement. When measuring pulse width, the output reflects the number of clock ticks for which the input signal was in the specified (low or high) state. See the table above for an example.

**Sample time** — Base sample time or a multiple of the base sample time.

**PCI slot (-1:autosearch)** — If only one board of this type is physically present in the target PC, enter

-1

to automatically locate the board.

If two or more boards of this type are physically present in the target PC, enter the bus number and the PCI slot number of the board associated with this driver block. Use the format [BusNumber, SlotNumber]. To determine the bus number and the PCI slot number, type

```
getxpcpci
```



## PCI-6024E

The PCI-6024E is an I/O board with 16 single or 8 differential analog input (A/D) channels (12-bit) with a maximum sample rate of 200 kHz, 2 analog output (D/A) channels (12-bit), 8 digital input and output lines, and 2 counter/timers (24-bit) with a maximum source clock rate of 20 MHz.

xPC Target supports this board with these driver blocks:

- “PCI-6024E Analog Input (A/D)” on page 22-32
- “PCI-6024E Analog Output (D/A)” on page 22-34
- “PCI-6024E Digital Input” on page 22-35
- “PCI-6024E Digital Output” on page 22-36
- “PCI-6024E Pulse Generation” on page 22-37
- “PCI-6024E Pulse Width/Period Measurement” on page 22-38

### Board Characteristics

|                                 |                                                                                                         |
|---------------------------------|---------------------------------------------------------------------------------------------------------|
| Board name                      | PCI-6024E                                                                                               |
| Manufacturer                    | National Instruments                                                                                    |
| Bus type                        | PCI                                                                                                     |
| Access method                   | Memory mapped                                                                                           |
| Multiple block instance support | A/D: No, D/A: No, Digital I/O: Yes;<br>Period/Pulsewidth measurement: Yes;<br>Pulsetrain Generation: No |
| Multiple board support          | Yes                                                                                                     |

## PCI-6024E Analog Input (A/D)

### Scaling Input to Output

| Hardware Input | Block Output Data Type | Scaling |
|----------------|------------------------|---------|
| volts          | Double                 | 1       |

### Driver Block Parameters

**Channel vector** — Enter numbers between 1 and 16. This driver allows you to enter channel numbers in any order.

For example, to use the first, second and fifth channels, enter

[ 1, 2, 5 ]

Number the channels beginning with 1 even if the board manufacturer starts numbering the channels with 0.

**Range vector** — Enter a range code for each of the channels in the channel vector. The range vector must be the same length as the channel vector. This driver allows each channel to be different.

The following table is a list of the ranges for this driver and the corresponding range codes.

| Input Range (V) | Range Code | Input Range (V) | Range Code |
|-----------------|------------|-----------------|------------|
| -10 to +10      | -10        | -0.5 to +0.5    | -0.5       |
| -5 to +5        | -5         | -0.05 to +0.05  | -0.05      |

For example, if the first channel is -10 to + 10 volts and the second and fifth channels are 0 to +1 volts, enter

[ -10, 1, 1 ]

**Input coupling vector** — Enter a coupling code for each of the channels in the channel vector. The coupling vector must be the same length as the channel vector. This driver allows a different coupling for each channel.

The following table is a list of the couplings for this driver and the corresponding coupling codes.

| <b>Coupling</b> | <b>Coupling Code</b> | <b>Description</b>                                                                                                                                                       |
|-----------------|----------------------|--------------------------------------------------------------------------------------------------------------------------------------------------------------------------|
| RSE             | 0                    | Analog input line connected to the positive input of the PGIA. Analog input ground (AIGND) internally connected to the negative input of the PGIA. See the board manual. |
| NRSE            | 1                    | Analog input line connected to the positive input of the PGIA. Analog input sense (AISENSE) connected to the negative input of the PGIA. See the board manual.           |
| DIFF            | 2                    | First analog input line connected to the positive input of the PGIA. Second analog input line connected to the negative input of the PGIA. See the board manual.         |

For example, if the first and second channels are single input and the fifth channel is a differential input, enter

[0,0,2]

The driver selects a second differential input 8 channels higher than the first channel. In the example above, the driver would select the thirteenth channel as a differential input with the fifth channel.

**Sample time** — Model base sample time or a multiple of the base sample time.

**PCI Slot (-1:autosearch)** — If only one board of this type is physically present in the target PC, enter

-1

to automatically locate the board.

If two or more boards of this type are physically present in the target PC, enter the bus number and the PCI slot number of the board associated with this driver block. Use the format [BusNumber, SlotNumber]. To determine the bus number and the PCI slot number, type

```
getxpcpci
```

## PCI-6024E Analog Output (D/A)

The analog output range of this board is set -10 to +10 volts.

### Scaling Input to Output

| Hardware Output | Block Input Data Type | Scaling |
|-----------------|-----------------------|---------|
| volts           | Double                | 1       |

### Driver Block Parameters

**Channel vector** — Enter 1 or 2. This driver allows the selection of individual D/A channels in any order. The number of elements defines the number of D/A channels used. For example, to use both of the analog output channels, enter

```
[1,2]
```

Number the channels beginning with 1 even if the board manufacturer starts numbering the channels with 0.

**Reset vector** — The reset vector controls the behavior of the channel at model termination. Enter a scalar or a vector that is the same length as the channel vector. If you specify a scalar value, that setting is used for all channels. If you specify a value of 1, the corresponding channel is reset to the value specified in the initial value vector. If you specify a value of 0, the channel remains at the last value attained while the model was running.

**Initial value vector** — The initial value vector contains the initial voltage values for the output channels. Enter a scalar or a vector that is the same length as the channel vector. If you specify a scalar value, that value is the initial value for all channels. The channels are set to the initial values between the time the model is downloaded and the time it is started.

**Sample time** — Base sample time or a multiple of the base sample time.

**PCI Slot (-1:autosearch)** — If only one board of this type is physically present in the target PC, enter

-1

to automatically locate the board.

If two or more boards of this type are physically present in the target PC, enter the bus number and the PCI slot number of the board associated with this driver block. Use the format [BusNumber, SlotNumber]. To determine the bus number and the PCI slot number, type

```
getxpcpci
```

## PCI-6024E Digital Input

### Scaling Input to Output

| Hardware Input | Block Output Data Type | Scaling                         |
|----------------|------------------------|---------------------------------|
| TTL            | Double                 | TTL low = 0.0<br>TTL high = 1.0 |

### Driver Block Parameters

**Channel vector** — Enter numbers between 1 and 8 to select the digital input lines used with this port. This driver allows the selection of individual digital input lines in any order. The number of elements defines the number of digital lines used.

For example, to use all of the digital inputs for one port, enter

```
[1,2,3,4,5,6,7,8]
```

Number the lines beginning with 1 even if the board manufacturer starts numbering the lines with 0.

**Sample time** — Enter a base sample time or a multiple of the base sample time.

**PCI Slot (-1:autosearch)** — If only one board of this type is physically present in the target PC, enter

-1

to automatically locate the board.

If two or more boards of this type are physically present in the target PC, enter the bus number and the PCI slot number of the board associated with this driver block. Use the format [BusNumber, SlotNumber]. To determine the bus number and the PCI slot number, type

getxpcpci

## PCI-6024E Digital Output

### Scaling Input to Output

| Hardware Output | Block Input Data Type | Scaling                             |
|-----------------|-----------------------|-------------------------------------|
| TTL             | Double                | < 0.5 = TTL low<br>≥ 0.5 = TTL high |

### Driver Block Parameters

**Channel vector** — Enter numbers between 1 and 8 to select the digital output lines used with this port. This driver allows the selection of individual digital output lines in any order. The number of elements defines the number of digital lines used.

For example, to use all of the digital outputs for one port, enter

[1,2,3,4,5,6,7,8]

Number the lines beginning with 1 even if the board manufacturer starts numbering the lines with 0.

**Reset vector** — The reset vector controls the behavior of the channel at model termination. Enter a scalar or a vector that is the same length as the channel vector. If you specify a scalar value, that setting is used for all channels. If you specify a value of 1, the corresponding channel is reset to the value specified in

the initial value vector. If you specify a value of 0, the channel remains at the last value attained while the model was running.

**Initial value vector** — The initial value vector contains the initial values (0 or 1) of the output channels. Enter a scalar or a vector that is the same length as the channel vector. If you enter a scalar, that value is used for all channels. The channels are set to these initial values between the time the model is downloaded and the time it is started.

**Sample time** — Enter a base sample time or a multiple of the base sample time.

**PCI Slot (-1:autosearch)** — If only one board of this type is physically present in the target PC, enter

-1

to automatically locate the board.

If two or more boards of this type are physically present in the target PC, enter the bus number and the PCI slot number of the board associated with this driver block. Use the format [BusNumber, SlotNumber]. To determine the bus number and the PCI slot number, type

```
getxpcpci
```

## PCI-6024E Pulse Generation

The inputs to the block should be a two element vector. The first element is the number of counts (of the 20 MHz source clock) that the counter should maintain at a low level, and the second element is the number of clock ticks for a high level. For example, to generate a pulsetrain at 1KHz with 25% low and 75% high, use the vector

```
[5000 15000]
```

### Driver Block Parameters

**Counter** — From the list, choose Counter 0, Counter 1, or Both to select the counter(s) to be used with this driver block. In each case, one block is needed for each physical board.

**Sample time** — Base sample time or a multiple of the base sample time.

**PCI slot (-1:autosearch)** — If only one board of this type is physically present in the target PC, enter

-1

to automatically locate the board.

If two or more boards of this type are physically present in the target PC, enter the bus number and the PCI slot number of the board associated with this driver block. Use the format [BusNumber, SlotNumber]. To determine the bus number and the PCI slot number, type

```
getxpcpci
```

## PCI-6024E Pulse Width/Period Measurement

### Driver Block Parameters

**Counter** — From the list, select a counter from 0 or 1.

**Trigger mode** — From the list, choose Level Triggered or Edge Triggered. See the table below for an example of how **Trigger mode** and **Polarity** affect one another. In this table, the data in the Output column resulted from a 1KHz pulse train with a 25% low and a 75% high pulse.

**Polarity** — From the list, choose Active low or Active high. See the table below for an example of how **Trigger mode** and **Polarity** affect one another. In this table, the data in the Output column resulted from a 1KHz pulse train with a 25% low and a 75% high pulse.

| Measurement objective    | Trigger mode    | Polarity    | Output |
|--------------------------|-----------------|-------------|--------|
| Pulse width (low pulse)  | Level Triggered | Active low  | 5000   |
| Pulse width (high pulse) | Level Triggered | Active High | 15000  |
| Period                   | Edge Triggered  | NA          | 20000  |



In every case, the output of the block is the number of clock ticks (of the 20MHz source clock) required for the specified measurement. When measuring pulse width, the output reflects the number of clock ticks for which the input signal was in the specified (low or high) state. See the table above for an example.

**Sample time** — Base sample time or a multiple of the base sample time.

**PCI slot (-1:autosearch)** — If only one board of this type is physically present in the target PC, enter

-1

to automatically locate the board.

If two or more boards of this type are physically present in the target PC, enter the bus number and the PCI slot number of the board associated with this driver block. Use the format [BusNumber, SlotNumber]. To determine the bus number and the PCI slot number, type

`getxpcpci`

## PCI-6025E

The PCI-6025E is an I/O board with 16 single or 8 differential analog inputs (A/D) channels (12-bit) with a maximum sample rate of 200 kHz, 2 analog output channels (12-bit), 32 digital input and output lines, and 2 counter/timers (24-bit) with a maximum source clock rate of 20 MHz.

The PCI-6025E provides 8 digital input and output lines, the PCI-6025E 8255 provides an additional 24 digital input and output lines.

xPC Target supports this board with these driver blocks:

- “PCI-6025E Analog Input (A/D)” on page 22-41
- “PCI-6025E Analog Output (D/A)” on page 22-43
- “PCI-6025E and PCI-6025E 8255 Digital Input” on page 22-44
- “PCI-6025E Digital Output” on page 22-45
- “PCI-6025E Pulse Generation” on page 22-46
- “PCI-6025E Pulse Width/Period Measurement” on page 22-47

### Board Characteristics

|                                 |                                                                                                         |
|---------------------------------|---------------------------------------------------------------------------------------------------------|
| Board name                      | PCI-6025E                                                                                               |
| Manufacturer                    | National Instruments                                                                                    |
| Bus type                        | PCI                                                                                                     |
| Access method                   | Memory mapped                                                                                           |
| Multiple block instance support | A/D: No, D/A: No, Digital I/O: Yes;<br>Period/Pulsewidth measurement: Yes;<br>Pulsetrain Generation: No |
| Multiple board support          | Yes                                                                                                     |

## PCI-6025E Analog Input (A/D)

### Scaling Input to Output

| Hardware Input | Block Output Data Type | Scaling |
|----------------|------------------------|---------|
| volts          | Double                 | 1       |

### Driver Block Parameters

**Channel vector** — Enter numbers between 1 and 16. This driver allows you to enter channel numbers in any order.

For example, to use the first, second and fifth channels, enter

[ 1, 2, 5 ]

Number the channels beginning with 1 even if the board manufacturer starts numbering the channels with 0.

**Range vector** — Enter a range code for each of the channels in the channel vector. The range vector must be the same length as the channel vector. This driver allows each channel to be different.

The following table is a list of the ranges for this driver and the corresponding range codes.

| Input Range (V) | Range Code | Input Range (V) | Range Code |
|-----------------|------------|-----------------|------------|
| -10 to +10      | -10        | -0.5 to +0.5    | -0.5       |
| -5 to +5        | -5         | -0.05 to +0.05  | -0.05      |

For example, if the first channel is -10 to + 10 volts and the second and fifth channels are 0 to +1 volts, enter

[ -10, 1, 1 ]

**Input coupling vector** — Enter a coupling code for each of the channels in the channel vector. The coupling vector must be the same length as the channel vector. This driver allows a different coupling for each channel.

The following table is a list of the couplings for this driver and the corresponding coupling codes.

| <b>Coupling</b> | <b>Coupling Code</b> | <b>Description</b>                                                                                                                                                       |
|-----------------|----------------------|--------------------------------------------------------------------------------------------------------------------------------------------------------------------------|
| RSE             | 0                    | Analog input line connected to the positive input of the PGIA. Analog input ground (AIGND) internally connected to the negative input of the PGIA. See the board manual. |
| NRSE            | 1                    | Analog input line connected to the positive input of the PGIA. Analog input sense (AISENSE) connected to the negative input of the PGIA. See the board manual.           |
| DIFF            | 2                    | First analog input line connected to the positive input of the PGIA. Second analog input line connected to the negative input of the PGIA. See the board manual.         |

For example, if the first and second channels are single input and the fifth channel is a differential input, enter

[0,0,2]

The driver selects a second differential input 8 channels higher than the first channel. In the example above, the driver would select the thirteenth channel as a differential input with the fifth channel.

**Sample time** — Model base sample time or a multiple of the base sample time.

**PCI Slot (-1:autosearch)** — If only one board of this type is physically present in the target PC, enter

-1

to automatically locate the board.

If two or more boards of this type are physically present in the target PC, enter the bus number and the PCI slot number of the board associated with this

driver block. Use the format [BusNumber, SlotNumber]. To determine the bus number and the PCI slot number, type

```
getxpcpci
```

## PCI-6025E Analog Output (D/A)

The analog output range of this board is set -10 to +10 volts.

### Scaling Input to Output

| Hardware Output | Block Input Data Type | Scaling |
|-----------------|-----------------------|---------|
| volts           | Double                | 1       |

### Driver Block Parameters

**Channel vector** — Enter 1 or 2. This driver allows the selection of individual D/A channels in any order. The number of elements defines the number of D/A channels used. For example, to use both of the analog output channels, enter

```
[1,2]
```

Number the channels beginning with 1 even if the board manufacturer starts numbering the channels with 0.

**Reset vector** — The reset vector controls the behavior of the channel at model termination. Enter a scalar or a vector that is the same length as the channel vector. If you specify a scalar value, that setting is used for all channels. If you specify a value of 1, the corresponding channel is reset to the value specified in the initial value vector. If you specify a value of 0, the channel remains at the last value attained while the model was running.

**Initial value vector** — The initial value vector contains the initial voltage values for the output channels. Enter a scalar or a vector that is the same length as the channel vector. If you specify a scalar value, that value is the initial value for all channels. The channels are set to the initial values between the time the model is downloaded and the time it is started.

**Sample time** — Base sample time or a multiple of the base sample time.

**PCI Slot (-1:autosearch)** — If only one board of this type is physically present in the target PC, enter

-1

to automatically locate the board.

If two or more boards of this type are physically present in the target PC, enter the bus number and the PCI slot number of the board associated with this driver block. Use the format [BusNumber, SlotNumber]. To determine the bus number and the PCI slot number, type

getxpcpci

## PCI-6025E and PCI-6025E 8255 Digital Input

### Scaling Input to Output

| Hardware Input | Block Output Data Type | Scaling                         |
|----------------|------------------------|---------------------------------|
| TTL            | Double                 | TTL low = 0.0<br>TTL high = 1.0 |

### Driver Block Parameters

**Channel vector** — Enter numbers between 1 and 8 to select the digital input lines used with this port. This driver allows the selection of individual digital input lines in any order. The number of elements defines the number of digital lines used.

For example, to use all of the digital inputs for one port, enter

[1,2,3,4,5,6,7,8]

Number the lines beginning with 1 even if the board manufacturer starts numbering the lines with 0.

**Port** — (PCI-6025E 8255) From the list choose either A, B, or C. The I/O board has an 82C55A chip with 3 ports. The port name defines which port of the 82C55A chip is used for this driver block. Each port has a maximum of 8 digital lines that can be configured as inputs. The PCI-6025E provides 8 digital input lines, the PCI-6025E 8255 provides an additional 24 digital input lines,

distributed across the ports A, B, and C. In each case, one block is needed for each port.

**Sample time** — Enter a base sample time or a multiple of the base sample time.

**PCI Slot (-1:autosearch)** — If only one board of this type is physically present in the target PC, enter

-1

to automatically locate the board.

If two or more boards of this type are physically present in the target PC, enter the bus number and the PCI slot number of the board associated with this driver block. Use the format [BusNumber, SlotNumber]. To determine the bus number and the PCI slot number, type

```
getxpcpci
```

## PCI-6025E Digital Output

### Scaling Input to Output

| Hardware Output | Block Input Data Type | Scaling                             |
|-----------------|-----------------------|-------------------------------------|
| TTL             | Double                | < 0.5 = TTL low<br>≥ 0.5 = TTL high |

### Driver Block Parameters

**Channel vector** — Enter numbers between 1 and 8 to select the digital output lines used with this port. This driver allows the selection of individual digital output lines in any order. The number of elements defines the number of digital lines used.

For example, to use all of the digital outputs for one port, enter

```
[1,2,3,4,5,6,7,8]
```

Number the lines beginning with 1 even if the board manufacturer starts numbering the lines with 0.

**Port** — (PCI-6025E 8255) From the list choose either A, B, or C. The I/O board has an 82C55A chip with 3 ports. The port name defines which port of the 82C55A chip is used for this driver block. Each port has a maximum of 8 digital lines that can be configured as inputs. The PCI-6025E provides 8 digital input lines, the PCI-6025E 8255 provides an additional 24 digital input lines, distributed across the ports A, B, and C. In each case, one block is needed for each port.

**Reset vector** — The reset vector controls the behavior of the channel at model termination. Enter a scalar or a vector that is the same length as the channel vector. If you specify a scalar value, that setting is used for all channels. If you specify a value of 1, the corresponding channel is reset to the value specified in the initial value vector. If you specify a value of 0, the channel remains at the last value attained while the model was running.

**Initial value vector** — The initial value vector contains the initial values (0 or 1) of the output channels. Enter a scalar or a vector that is the same length as the channel vector. If you enter a scalar, that value is used for all channels. The channels are set to these initial values between the time the model is downloaded and the time it is started.

**Sample time** — Enter a base sample time or a multiple of the base sample time.

**PCI Slot (-1:autosearch)** — If only one board of this type is physically present in the target PC, enter

-1

to automatically locate the board.

If two or more boards of this type are physically present in the target PC, enter the bus number and the PCI slot number of the board associated with this driver block. Use the format [BusNumber, SlotNumber]. To determine the bus number and the PCI slot number, type

```
getxpcpci
```

## PCI-6025E Pulse Generation

The inputs to the block should be a two element vector. The first element is the number of counts (of the 20 MHz source clock) that the counter should maintain at a low level, and the second element is the number of clock ticks for



a high level. For example, to generate a pulsetrain at 1KHz with 25% low and 75% high, use the vector

```
[5000 15000]
```

### Driver Block Parameters

**Counter** — From the list, choose Counter 0, Counter 1, or Both to select the counter(s) to be used with this driver block. In each case, one block is needed for each physical board.

**Sample time** — Base sample time or a multiple of the base sample time.

**PCI slot (-1:autosearch)** — If only one board of this type is physically present in the target PC, enter

```
-1
```

to automatically locate the board.

If two or more boards of this type are physically present in the target PC, enter the bus number and the PCI slot number of the board associated with this driver block. Use the format [BusNumber, SlotNumber]. To determine the bus number and the PCI slot number, type

```
getxpcpci
```

## PCI-6025E Pulse Width/Period Measurement

### Driver Block Parameters

**Counter** — From the list, select a counter from 0 or 1.

**Trigger mode** — From the list, choose Level Triggered or Edge Triggered. See the table below for an example of how **Trigger mode** and **Polarity** affect one another. In this table, the data in the Output column resulted from a 1KHz pulse train with a 25% low and a 75% high pulse.

**Polarity** — From the list, choose Active low or Active high. See the table below for an example of how **Trigger mode** and **Polarity** affect one another. In

this table, the data in the Output column resulted from a 1KHz pulse train with a 25% low and a 75% high pulse.

| <b>Measurement objective</b> | <b>Trigger mode</b> | <b>Polarity</b> | <b>Output</b> |
|------------------------------|---------------------|-----------------|---------------|
| Pulse width (low pulse)      | Level Triggered     | Active low      | 5000          |
| Pulse width (high pulse)     | Level Triggered     | Active High     | 15000         |
| Period                       | Edge Triggered      | NA              | 20000         |

In every case, the output of the block is the number of clock ticks (of the 20MHz source clock) required for the specified measurement. When measuring pulse width, the output reflects the number of clock ticks for which the input signal was in the specified (low or high) state. See the table above for an example.

**Sample time** — Base sample time or a multiple of the base sample time.

**PCI slot (-1:autosearch)** — If only one board of this type is physically present in the target PC, enter

-1

to automatically locate the board.

If two or more boards of this type are physically present in the target PC, enter the bus number and the PCI slot number of the board associated with this driver block. Use the format [BusNumber, SlotNumber]. To determine the bus number and the PCI slot number, type

```
getxpcpci
```

## PCI-6030E (Formerly PCI-MIO-16XE-10)

The PCI-6030E is an I/O board with 16 single or 8 differential analog input (A/D) channels (16-bit) with a maximum sample rate of 100 kHz, 2 analog output (D/A) channels (16-bit), 8 digital input and output lines, and 2 counter/timers (24-bit) with a maximum source clock rate of 20 MHz.

xPC Target supports this board with these driver blocks:

- “PCI-6030E Analog Input (A/D)” on page 22-50
- “PCI-6030E Analog Output (D/A)” on page 22-52
- “PCI-6030E Digital Input” on page 22-54
- “PCI-6030E Digital Output” on page 22-55
- “PCI-6030E Pulse Generation” on page 22-56
- “PCI-6030E Pulse Width/Period Measurement” on page 22-57

### Board Characteristics

|                                 |                                                                                                         |
|---------------------------------|---------------------------------------------------------------------------------------------------------|
| Board name                      | PCI-6030E                                                                                               |
| Manufacturer                    | National Instruments                                                                                    |
| Bus type                        | PCI                                                                                                     |
| Access method                   | I/O mapped                                                                                              |
| Multiple block instance support | A/D: No, D/A: No, Digital I/O: Yes;<br>Period/Pulsewidth measurement: Yes;<br>Pulsetrain Generation: No |
| Multiple board support          | Yes                                                                                                     |

## PCI-6030E Analog Input (A/D)

### Scaling of Input to Output

| Hardware Input | Block Output Data Type | Scaling |
|----------------|------------------------|---------|
| volts          | Double                 | 1       |

### Driver Block Parameters

**Channel vector** — Enter numbers between 1 and 16. This driver allows you to enter channel numbers in any order.

For example, to use the first, second and fifth channels, enter

[1,2,5]

Number the channels beginning with 1, even if the board manufacturer starts numbering the channels with 0.

**Range vector** — Enter a range code for each of the channels in the channel vector. The range vector must be the same length as the channel vector. This driver allows each channel to be different.

The following table is a list of the ranges for this driver and the corresponding range codes.

| Input Range (V) | Range Code | Input Range (V) | Range Code |
|-----------------|------------|-----------------|------------|
| -10 to +10      | -10        | 0 - 10          | 10         |
| -5 to +5        | -5         | 0 - 5           | 5          |
| -2 to +2        | -2         | 0 - 2           | 2          |
| -1 to + 1       | -1         | 0 - 1           | 1          |
| -0.5 to +0.5    | -0.5       | 0 - 0.5         | 0.5        |
| -0.2 to +0.2    | -0.2       | 0 - 0.2         | 0.2        |
| -0.1 to +0.1    | -0.1       | 0 - 0.1         | 0.1        |

For example, if the first channel is -10 to + 10 volts and the second and fifth channels are 0 to +1 volts, enter

[ -10,1,1]

**Input coupling vector** — Enter a coupling code for each of the channels in the channel vector. The coupling vector must be the same length as the channel vector. This driver allows a different coupling for each channel.

The following table is a list of the couplings for this driver and the corresponding coupling codes.

| Coupling | Coupling Code | Description                                                                                                                                                              |
|----------|---------------|--------------------------------------------------------------------------------------------------------------------------------------------------------------------------|
| RSE      | 0             | Analog input line connected to the positive input of the PGIA. Analog input ground (AIGND) internally connected to the negative input of the PGIA. See the board manual. |
| NRSE     | 1             | Analog input line connected to the positive input of the PGIA. Analog input sense (AISENSE) connected to the negative input of the PGIA. See the board manual.           |
| DIFF     | 2             | First analog input line connected to the positive input of the PGIA. Second analog input line connected to the negative input of the PGIA. See the board manual.         |

For example, if the first and second channels are single input and the fifth channel is a differential input, enter

[0,0,2]

The driver selects a second differential input 8 channels higher than the first channel. In the example above, the driver would select the thirteenth channel as a differential input with the fifth channel.

**Sample time** — Model base sample time or a multiple of the base sample time.

**PCI Slot (-1:autosearch)** — If only one board of this type is physically present in the target PC, enter

-1

to automatically locate the board.

If two or more boards of this type are physically present in the target PC, enter the bus number and the PCI slot number of the board associated with this driver block. Use the format [BusNumber, SlotNumber]. To determine the bus number and the PCI slot number, type

getxpcpci

## PCI-6030E Analog Output (D/A)

The analog output range of this board is set -10 to +10 volts.

### Scaling of Input to Output

| Hardware Output | Block Input Data Type | Scaling |
|-----------------|-----------------------|---------|
| volts           | Double                | 1       |

### Driver Block Parameters

**Channel vector** — Enter 1 or 2. This driver allows the selection of individual D/A channels in any order. The number of elements defines the number of D/A channels used. For example, to use both of the analog output channels, enter

[1,2]

Number the channels begin with 1 even if the board manufacturer starts numbering the channels with 0.

**Range vector** — Enter a range code for each of the channels in the channel vector. The range vector must be the same length as the channel vector. This board allows the range of each channel to be different.

The following table is a list of the ranges for this driver and the corresponding range codes.

| <b>Input Range (V)</b> | <b>Range Code</b> | <b>Input Range (V)</b> | <b>Range Code</b> |
|------------------------|-------------------|------------------------|-------------------|
| -10 to +10             | -10               | 0 - 10                 | 10                |

For example, if the first channel is -10 to +10 volts, and the second channel is 0 to 10volts, enter

```
[ -10,10]
```

**Reset vector** — The reset vector controls the behavior of the channel at model termination. Enter a scalar or a vector that is the same length as the channel vector. If you specify a scalar value, that setting is used for all channels. If you specify a value of 1, the corresponding channel is reset to the value specified in the initial value vector. If you specify a value of 0, the channel remains at the last value attained while the model was running.

**Initial value vector** — The initial value vector contains the initial voltage values for the output channels. Enter a scalar or a vector that is the same length as the channel vector. If you specify a scalar value, that value is the initial value for all channels. The channels are set to the initial values between the time the model is downloaded and the time it is started.

**Sample time** — Base sample time or a multiple of the base sample time.

**PCI Slot (-1:autosearch)** — If only one board of this type is physically present in the target PC, enter

```
-1
```

to automatically locate the board.

If two or more boards of this type are physically present in the target PC, enter the bus number and the PCI slot number of the board associated with this driver block. Use the format [BusNumber, SlotNumber]. To determine the bus number and the PCI slot number, type

```
getxpcpci
```

## PCI-6030E Digital Input

### Scaling of Input to Output

| Hardware Input | Block Output Data Type | Scaling                         |
|----------------|------------------------|---------------------------------|
| TTL            | Double                 | TTL low = 0.0<br>TTL high = 1.0 |

### Driver Block Parameters

**Channel vector** — Enter numbers between 1 and 8 to select the digital input lines used with this port. This driver allows the selection of individual digital input lines in any order. The number of elements defines the number of digital lines used.

For example, to use all of the digital inputs for one port, enter

```
[1,2,3,4,5,6,7,8]
```

Number the lines beginning with 1 even if the board manufacturer starts numbering the lines with 0.

**Sample time** — Enter a base sample time or a multiple of the base sample time.

**PCI Slot (-1:autosearch)** — If only one board of this type is physically present in the target PC, enter

```
-1
```

to automatically locate the board.

If two or more boards of this type are physically present in the target PC, enter the bus number and the PCI slot number of the board associated with this driver block. Use the format [BusNumber, SlotNumber]. To determine the bus number and the PCI slot number, type

```
getxpcpci
```



## PCI-6030E Digital Output

### Scaling of Input to Output

| Hardware Output | Block Input Data Type | Scaling                             |
|-----------------|-----------------------|-------------------------------------|
| TTL             | Double                | < 0.5 = TTL low<br>≥ 0.5 = TTL high |

### Driver Block Parameters

**Channel vector** — Enter numbers between 1 and 8 to select the digital output lines used with this port. This driver allows the selection of individual digital output lines in any order. The number of elements defines the number of digital lines used.

For example, to use all of the digital outputs for one port, enter

```
[1,2,3,4,5,6,7,8]
```

Number the lines beginning with 1 even if the board manufacturer starts numbering the lines with 0.

**Reset vector** — The reset vector controls the behavior of the channel at model termination. Enter a scalar or a vector that is the same length as the channel vector. If you specify a scalar value, that setting is used for all channels. If you specify a value of 1, the corresponding channel is reset to the value specified in the initial value vector. If you specify a value of 0, the channel remains at the last value attained while the model was running.

**Initial value vector** — The initial value vector contains the initial values (0 or 1) of the output channels. Enter a scalar or a vector that is the same length as the channel vector. If you enter a scalar, that value is used for all channels. The channels are set to these initial values between the time the model is downloaded and the time it is started.

**Sample time** — Enter a base sample time or a multiple of the base sample time.

**PCI Slot (-1:autosearch)** — If only one board of this type is physically present in the target PC, enter

```
-1
```

to automatically locate the board.

If two or more boards of this type are physically present in the target PC, enter the bus number and the PCI slot number of the board associated with this driver block. Use the format [BusNumber, SlotNumber]. To determine the bus number and the PCI slot number, type

```
getxpcpci
```

## PCI-6030E Pulse Generation

The inputs to the block should be a two element vector. The first element is the number of counts (of the 20 MHz source clock) that the counter should maintain at a low level, and the second element is the number of clock ticks for a high level. For example, to generate a pulsetrain at 1KHz with 25% low and 75% high, use the vector

```
[5000 15000]
```

### Driver Block Parameters

**Counter** — From the list, choose Counter 0, Counter 1, or Both to select the counter(s) to be used with this driver block. In each case, one block is needed for each physical board.

**Sample time** — Base sample time or a multiple of the base sample time.

**PCI slot (-1:autosearch)** — If only one board of this type is physically present in the target PC, enter

```
-1
```

to automatically locate the board.

If two or more boards of this type are physically present in the target PC, enter the bus number and the PCI slot number of the board associated with this driver block. Use the format [BusNumber, SlotNumber]. To determine the bus number and the PCI slot number, type

```
getxpcpci
```

## PCI-6030E Pulse Width/Period Measurement

### Driver Block Parameters

**Counter** — From the list, select a counter from 0 or 1.

**Trigger mode** — From the list, choose Level Triggered or Edge Triggered. See the table below for an example of how **Trigger mode** and **Polarity** affect one another. In this table, the data in the Output column resulted from a 1KHz pulse train with a 25% low and a 75% high pulse.

**Polarity** — From the list, choose Active low or Active high. See the table below for an example of how **Trigger mode** and **Polarity** affect one another. In this table, the data in the Output column resulted from a 1KHz pulse train with a 25% low and a 75% high pulse.

| Measurement objective    | Trigger mode    | Polarity    | Output |
|--------------------------|-----------------|-------------|--------|
| Pulse width (low pulse)  | Level Triggered | Active low  | 5000   |
| Pulse width (high pulse) | Level Triggered | Active High | 15000  |
| Period                   | Edge Triggered  | NA          | 20000  |

In every case, the output of the block is the number of clock ticks (of the 20MHz source clock) required for the specified measurement. When measuring pulse width, the output reflects the number of clock ticks for which the input signal was in the specified (low or high) state. See the table above for an example.

**Sample time** — Base sample time or a multiple of the base sample time.

**PCI slot (-1:autosearch)** — If only one board of this type is physically present in the target PC, enter

-1

to automatically locate the board.

If two or more boards of this type are physically present in the target PC, enter the bus number and the PCI slot number of the board associated with this driver block. Use the format [BusNumber, SlotNumber]. To determine the bus number and the PCI slot number, type

```
getxpcpci
```

## PCI-6031E

The PCI-6031E is an I/O board with 64 single or 32 differential analog input (A/D) channels (16-bit) with a maximum sample rate of 100 kHz, 2 analog output (D/A) channels (16-bit), 8 digital input and output lines, and 2 counter/timers (24-bit) with a maximum source clock rate of 20 MHz.

xPC Target supports this board with these driver blocks:

- “PCI-6031E Analog Input (A/D)” on page 22-60
- “PCI-6031E Analog Output (D/A)” on page 22-62
- “PCI-6031E Digital Input” on page 22-64
- “PCI-6031E Digital Output” on page 22-65
- “PCI-6031E Pulse Generation” on page 22-66
- “PCI-6031E Pulse Width/Period Measurement” on page 22-67

### Board Characteristics

|                                 |                                                                                                         |
|---------------------------------|---------------------------------------------------------------------------------------------------------|
| Board name                      | PCI-6031E                                                                                               |
| Manufacturer                    | National Instruments                                                                                    |
| Bus type                        | PCI                                                                                                     |
| Access method                   | Memory mapped                                                                                           |
| Multiple block instance support | A/D: No, D/A: No, Digital I/O: Yes;<br>Period/Pulsewidth measurement: Yes;<br>Pulsetrain Generation: No |
| Multiple board support          | Yes                                                                                                     |

## PCI-6031E Analog Input (A/D)

### Scaling of Input to Output

| Hardware Input | Block Output Data Type | Scaling |
|----------------|------------------------|---------|
| volts          | Double                 | 1       |

### Driver Block Parameters

**Channel vector** — Enter numbers between 1 and 64. This driver allows you to enter channel numbers in any order.

For example, to use the first, second and fifth channels, enter

[1,2,5]

Number the channels beginning with 1, even if the board manufacturer starts numbering the channels with 0.

**Range vector** — Enter a range code for each of the channels in the channel vector. The range vector must be the same length as the channel vector. This driver allows each channel to be different.

The following table is a list of the ranges for this driver and the corresponding range codes.

| Input Range (V) | Range Code | Input Range (V) | Range Code |
|-----------------|------------|-----------------|------------|
| -10 to +10      | -10        | 0 - 10          | 10         |
| -5 to +5        | -5         | 0 - 5           | 5          |
| -2 to +2        | -2         | 0 - 2           | 2          |
| -1 to + 1       | -1         | 0 - 1           | 1          |
| -0.5 to +0.5    | -0.5       | 0 - 0.5         | 0.5        |
| -0.2 to +0.2    | -0.2       | 0 - 0.2         | 0.2        |
| -0.1 to +0.1    | -0.1       | 0 - 0.1         | 0.1        |

For example, if the first channel is -10 to + 10 volts and the second and fifth channels are 0 to +1 volts, enter

```
[ -10,1,1]
```

**Input coupling vector** — Enter a coupling code for each of the channels in the channel vector. The coupling vector must be the same length as the channel vector. This driver allows a different coupling for each channel.

The following table is a list of the couplings for this driver and the corresponding coupling codes.

| Coupling | Coupling Code | Description                                                                                                                                                              |
|----------|---------------|--------------------------------------------------------------------------------------------------------------------------------------------------------------------------|
| RSE      | 0             | Analog input line connected to the positive input of the PGIA. Analog input ground (AIGND) internally connected to the negative input of the PGIA. See the board manual. |
| NRSE     | 1             | Analog input line connected to the positive input of the PGIA. Analog input sense (AISENSE) connected to the negative input of the PGIA. See the board manual.           |
| DIFF     | 2             | First analog input line connected to the positive input of the PGIA. Second analog input line connected to the negative input of the PGIA. See the board manual.         |

For example, if the first and second channels are single input and the fifth channel is a differential input, enter

```
[0,0,2]
```

The driver selects a second differential input 8 channels higher than the first channel. In the example above, the driver would select the thirteenth channel as a differential input with the fifth channel.

**Sample time** — Model base sample time or a multiple of the base sample time.

**PCI Slot (-1:autosearch)** — If only one board of this type is physically present in the target PC, enter

-1

to automatically locate the board.

If two or more boards of this type are physically present in the target PC, enter the bus number and the PCI slot number of the board associated with this driver block. Use the format [BusNumber, SlotNumber]. To determine the bus number and the PCI slot number, type

getxpcpci

## PCI-6031E Analog Output (D/A)

The analog output range of this board is set -10 to +10 volts.

### Scaling of Input to Output

| Hardware Output | Block Input Data Type | Scaling |
|-----------------|-----------------------|---------|
| volts           | Double                | 1       |

### Driver Block Parameters

**Channel vector** — Enter 1 or 2. This driver allows the selection of individual D/A channels in any order. The number of elements defines the number of D/A channels used. For example, to use both of the analog output channels, enter

[1,2]

Number the channels begin with 1 even if the board manufacturer starts numbering the channels with 0.

**Range vector** — Enter a range code for each of the channels in the channel vector. The range vector must be the same length as the channel vector. This board allows the range of each channel to be different.



The following table is a list of the ranges for this driver and the corresponding range codes.

| <b>Input Range (V)</b> | <b>Range Code</b> | <b>Input Range (V)</b> | <b>Range Code</b> |
|------------------------|-------------------|------------------------|-------------------|
| -10 to +10             | -10               | 0 - 10                 | 10                |

For example, if the first channel is -10 to +10 volts, and the second channel is 0 to 10volts, enter

```
[ -10, 10]
```

**Reset vector** — The reset vector controls the behavior of the channel at model termination. Enter a scalar or a vector that is the same length as the channel vector. If you specify a scalar value, that setting is used for all channels. If you specify a value of 1, the corresponding channel is reset to the value specified in the initial value vector. If you specify a value of 0, the channel remains at the last value attained while the model was running.

**Initial value vector** — The initial value vector contains the initial voltage values for the output channels. Enter a scalar or a vector that is the same length as the channel vector. If you specify a scalar value, that value is the initial value for all channels. The channels are set to the initial values between the time the model is downloaded and the time it is started.

**Sample time** — Base sample time or a multiple of the base sample time.

**PCI Slot (-1:autosearch)** — If only one board of this type is physically present in the target PC, enter

```
-1
```

to automatically locate the board.

If two or more boards of this type are physically present in the target PC, enter the bus number and the PCI slot number of the board associated with this driver block. Use the format [BusNumber, SlotNumber]. To determine the bus number and the PCI slot number, type

```
getxpcpci
```

## PCI-6031E Digital Input

### Scaling of Input to Output

| Hardware Input | Block Output Data Type | Scaling                         |
|----------------|------------------------|---------------------------------|
| TTL            | Double                 | TTL low = 0.0<br>TTL high = 1.0 |

### Driver Block Parameters

**Channel vector** — Enter numbers between 1 and 8 to select the digital input lines used with this port. This driver allows the selection of individual digital input lines in any order. The number of elements defines the number of digital lines used.

For example, to use all of the digital inputs for one port, enter

```
[1,2,3,4,5,6,7,8]
```

Number the lines beginning with 1 even if the board manufacturer starts numbering the lines with 0.

**Sample time** — Enter a base sample time or a multiple of the base sample time.

**PCI Slot (-1:autosearch)** — If only one board of this type is physically present in the target PC, enter

```
-1
```

to automatically locate the board.

If two or more boards of this type are physically present in the target PC, enter the bus number and the PCI slot number of the board associated with this driver block. Use the format [BusNumber, SlotNumber]. To determine the bus number and the PCI slot number, type

```
getxpcpci
```

## PCI-6031E Digital Output

### Scaling of Input to Output

| Hardware Output | Block Input Data Type | Scaling                             |
|-----------------|-----------------------|-------------------------------------|
| TTL             | Double                | < 0.5 = TTL low<br>≥ 0.5 = TTL high |

### Driver Block Parameters

**Channel vector** — Enter numbers between 1 and 8 to select the digital output lines used with this port. This driver allows the selection of individual digital output lines in any order. The number of elements defines the number of digital lines used.

For example, to use all of the digital outputs for one port, enter

```
[1,2,3,4,5,6,7,8]
```

Number the lines beginning with 1 even if the board manufacturer starts numbering the lines with 0.

**Reset vector** — The reset vector controls the behavior of the channel at model termination. Enter a scalar or a vector that is the same length as the channel vector. If you specify a scalar value, that setting is used for all channels. If you specify a value of 1, the corresponding channel is reset to the value specified in the initial value vector. If you specify a value of 0, the channel remains at the last value attained while the model was running.

**Initial value vector** — The initial value vector contains the initial values (0 or 1) of the output channels. Enter a scalar or a vector that is the same length as the channel vector. If you enter a scalar, that value is used for all channels. The channels are set to these initial values between the time the model is downloaded and the time it is started.

**Sample time** — Enter a base sample time or a multiple of the base sample time.

**PCI Slot (-1:autosearch)** — If only one board of this type is physically present in the target PC, enter

-1

to automatically locate the board.

If two or more boards of this type are physically present in the target PC, enter the bus number and the PCI slot number of the board associated with this driver block. Use the format [BusNumber, SlotNumber]. To determine the bus number and the PCI slot number, type

```
getxpcpci
```

## PCI-6031E Pulse Generation

The inputs to the block should be a two element vector. The first element is the number of counts (of the 20 MHz source clock) that the counter should maintain at a low level, and the second element is the number of clock ticks for a high level. For example, to generate a pulsetrain at 1KHz with 25% low and 75% high, use the vector

```
[5000 15000]
```

### Driver Block Parameters

**Counter** — From the list, choose Counter 0, Counter 1, or Both to select the counter(s) to be used with this driver block. In each case, one block is needed for each physical board.

**Sample time** — Base sample time or a multiple of the base sample time.

**PCI slot (-1:autosearch)** — If only one board of this type is physically present in the target PC, enter

-1

to automatically locate the board.

If two or more boards of this type are physically present in the target PC, enter the bus number and the PCI slot number of the board associated with this driver block. Use the format [BusNumber, SlotNumber]. To determine the bus number and the PCI slot number, type

```
getxpcpci
```

## PCI-6031E Pulse Width/Period Measurement

### Driver Block Parameters

**Counter** — From the list, select a counter from 0 or 1.

**Trigger mode** — From the list, choose Level Triggered or Edge Triggered. See the table below for an example of how **Trigger mode** and **Polarity** affect one another. In this table, the data in the Output column resulted from a 1KHz pulse train with a 25% low and a 75% high pulse.

**Polarity** — From the list, choose Active low or Active high. See the table below for an example of how **Trigger mode** and **Polarity** affect one another. In this table, the data in the Output column resulted from a 1KHz pulse train with a 25% low and a 75% high pulse.

| Measurement objective    | Trigger mode    | Polarity    | Output |
|--------------------------|-----------------|-------------|--------|
| Pulse width (low pulse)  | Level Triggered | Active low  | 5000   |
| Pulse width (high pulse) | Level Triggered | Active High | 15000  |
| Period                   | Edge Triggered  | NA          | 20000  |

In every case, the output of the block is the number of clock ticks (of the 20MHz source clock) required for the specified measurement. When measuring pulse width, the output reflects the number of clock ticks for which the input signal was in the specified (low or high) state. See the table above for an example.

**Sample time** — Base sample time or a multiple of the base sample time.

**PCI slot (-1:autosearch)** — If only one board of this type is physically present in the target PC, enter

-1

to automatically locate the board.

If two or more boards of this type are physically present in the target PC, enter the bus number and the PCI slot number of the board associated with this driver block. Use the format [BusNumber, SlotNumber]. To determine the bus number and the PCI slot number, type

```
getxpcpci
```

## PCI-6040E (Formerly PCI-MIO-16E-4)

The PCI-6040E is an I/O board with 16 single or 8 differential analog input channels (12-bit) with a maximum sample rate of 500 kHz, 2 analog output channels (12-bit), 8 digital input and output lines, and 2 counter/timers (24-bit) with a maximum source clock rate of 20 MHz.

xPC Target supports this board with these driver blocks:

- “PCI-6040E Analog Input (A/D)” on page 22-70
- “PCI-6040E Analog Output (D/A)” on page 22-72
- “PCI-6040E Digital Input” on page 22-74
- “PCI-6040E Digital Input” on page 22-74
- “PCI-6040E Pulse Generation” on page 22-76
- “PCI-6040E Pulse Width/Period Measurement” on page 22-77

### Board Characteristics

|                                 |                                                                                                         |
|---------------------------------|---------------------------------------------------------------------------------------------------------|
| Board name                      | PCI-6040E                                                                                               |
| Manufacturer                    | National Instruments                                                                                    |
| Bus type                        | PCI                                                                                                     |
| Access method                   | Memory mapped                                                                                           |
| Multiple block instance support | A/D: No, D/A: No, Digital I/O: Yes;<br>Period/Pulsewidth measurement: Yes;<br>Pulsetrain Generation: No |
| Multiple board support          | Yes                                                                                                     |

## PCI-6040E Analog Input (A/D)

### Scaling Input to Output

| Hardware Input | Block Output Data Type | Scaling |
|----------------|------------------------|---------|
| volts          | Double                 | 1       |

### Driver Block Parameters

**Channel vector** — Enter numbers between 1 and 16. This driver allows you to enter channel numbers in any order.

For example, to use the first, second and fifth channels, enter

[1,2,5]

Number the channels beginning with 1 even if the board manufacturer starts numbering the channels with 0.

**Range vector** — Enter a range code for each of the channels in the channel vector. The range vector must be the same length as the channel vector. This driver allows each channel to be different.

The following table is a list of the ranges for this driver and the corresponding range codes.

| Input Range (V) | Range Code | Input Range (V) | Range Code |
|-----------------|------------|-----------------|------------|
| -10 to +10      | -10        | 0 - 10          | 10         |
| -5 to +5        | -5         | 0 - 5           | 5          |
| -2 to +2        | -2         | 0 - 2           | 2          |
| -1 to + 1       | -1         | 0 - 1           | 1          |
| -0.5 to +0.5    | -0.5       | 0 - 0.5         | 0.5        |
| -0.2 to +0.2    | -0.2       | 0 - 0.2         | 0.2        |



| Input Range (V) | Range Code | Input Range (V) | Range Code |
|-----------------|------------|-----------------|------------|
| -0.1 to +0.1    | -0.1       | 0 - 0.1         | 0.1        |
| -0.05 to +0.05  | -0.05      |                 |            |

For example, if the first channel is -10 to + 10 volts and the second and fifth channels are 0 to +1 volts, enter

[ -10, 1, 1]

**Input coupling vector** — Enter a coupling code for each of the channels in the channel vector. The coupling vector must be the same length as the channel vector. This driver allows a different coupling for each channel.

The following table is a list of the couplings for this driver and the corresponding coupling codes.

| Coupling | Coupling Code | Description                                                                                                                                                              |
|----------|---------------|--------------------------------------------------------------------------------------------------------------------------------------------------------------------------|
| RSE      | 0             | Analog input line connected to the positive input of the PGIA. Analog input ground (AIGND) internally connected to the negative input of the PGIA. See the board manual. |
| NRSE     | 1             | Analog input line connected to the positive input of the PGIA. Analog input sense (AISENSE) connected to the negative input of the PGIA. See the board manual.           |
| DIFF     | 2             | First analog input line connected to the positive input of the PGIA. Second analog input line connected to the negative input of the PGIA. See the board manual.         |

For example, if the first and second channels are single input and the fifth channel is a differential input, enter

[0, 0, 2]

The driver selects a second differential input 8 channels higher than the first channel. In the example above, the driver would select the thirteenth channel as a differential input with the fifth channel.

**Sample time** — Model base sample time or a multiple of the base sample time.

**PCI Slot (-1:autosearch)** — If only one board of this type is physically present in the target PC, enter

-1

to automatically locate the board.

If two or more boards of this type are physically present in the target PC, enter the bus number and the PCI slot number of the board associated with this driver block. Use the format [BusNumber, SlotNumber]. To determine the bus number and the PCI slot number, type

```
getxpcpci
```

## PCI-6040E Analog Output (D/A)

### Scaling Input to Output

| Hardware Output | Block Input Data Type | Scaling |
|-----------------|-----------------------|---------|
| volts           | Double                | 1       |

### Driver Block Parameters

**Channel vector** — Enter 1 or 2. This driver allows the selection of individual D/A channels in any order. The number of elements defines the number of D/A channels used. For example, to use both of the analog output channels, enter

[1,2]

Number the channels beginning with 1 even if the board manufacturer starts numbering the channels with 0.

**Range vector** — Enter a range code for each of the channels in the channel vector. The range vector must be the same length as the channel vector. This board allows the range of each channel to be different.

The following table is a list of the ranges for this driver and the corresponding range codes.

| <b>Input Range (V)</b> | <b>Range Code</b> | <b>Input Range (V)</b> | <b>Range Code</b> |
|------------------------|-------------------|------------------------|-------------------|
| -10 to +10             | -10               | 0 - 10                 | 10                |

For example, if the first channel is -10 to +10 volts, and the second channel is 0 to 5 volts, enter

```
[ -10,5]
```

**Reset vector** — The reset vector controls the behavior of the channel at model termination. Enter a scalar or a vector that is the same length as the channel vector. If you specify a scalar value, that setting is used for all channels. If you specify a value of 1, the corresponding channel is reset to the value specified in the initial value vector. If you specify a value of 0, the channel remains at the last value attained while the model was running.

**Initial value vector** — The initial value vector contains the initial voltage values for the output channels. Enter a scalar or a vector that is the same length as the channel vector. If you specify a scalar value, that value is the initial value for all channels. The channels are set to the initial values between the time the model is downloaded and the time it is started.

**Sample time** — Base sample time or a multiple of the base sample time.

**PCI Slot (-1:autosearch)** — If only one board of this type is physically present in the target PC, enter

```
-1
```

to automatically locate the board.

If two or more boards of this type are physically present in the target PC, enter the bus number and the PCI slot number of the board associated with this driver block. Use the format [BusNumber, SlotNumber]. To determine the bus number and the PCI slot number, type

```
getxpcpci
```

## PCI-6040E Digital Input

### Scaling Input to Output

| Hardware Input | Block Output Data Type | Scaling                         |
|----------------|------------------------|---------------------------------|
| TTL            | Double                 | TTL low = 0.0<br>TTL high = 1.0 |

### Driver Block Parameters

**Channel vector** — Enter numbers between 1 and 8 to select the digital input lines used with this port. This driver allows the selection of individual digital input lines in any order. The number of elements defines the number of digital lines used.

For example, to use all of the digital inputs for one port, enter

```
[ 1, 2, 3, 4, 5, 6, 7, 8]
```

Number the lines beginning with 1 even if the board manufacturer starts numbering the lines with 0.

**Sample time** — Enter a base sample time or a multiple of the base sample time.

**PCI Slot (-1:autosearch)** — If only one board of this type is physically present in the target PC, enter

```
- 1
```

to automatically locate the board.

If two or more boards of this type are physically present in the target PC, enter the bus number and the PCI slot number of the board associated with this driver block. Use the format [BusNumber, SlotNumber]. To determine the bus number and the PCI slot number, type

```
getxpcpci
```

## PCI-6040E Digital Output

### Scaling of Input to Output

| Hardware Output | Block Input Data Type | Scaling                             |
|-----------------|-----------------------|-------------------------------------|
| TTL             | Double                | < 0.5 = TTL low<br>≥ 0.5 = TTL high |

### Driver Block Parameters

**Channel vector** — Enter numbers between 1 and 8 to select the digital output lines used with this port. This driver allows the selection of individual digital output lines in any order. The number of elements defines the number of digital lines used.

For example, to use all of the digital outputs for one port, enter

```
[1,2,3,4,5,6,7,8]
```

Number the lines beginning with 1 even if the board manufacturer starts numbering the lines with 0.

**Reset vector** — The reset vector controls the behavior of the channel at model termination. Enter a scalar or a vector that is the same length as the channel vector. If you specify a scalar value, that setting is used for all channels. If you specify a value of 1, the corresponding channel is reset to the value specified in the initial value vector. If you specify a value of 0, the channel remains at the last value attained while the model was running.

**Initial value vector** — The initial value vector contains the initial values (0 or 1) of the output channels. Enter a scalar or a vector that is the same length as the channel vector. If you enter a scalar, that value is used for all channels. The channels are set to these initial values between the time the model is downloaded and the time it is started.

**Sample time** — Enter a base sample time or a multiple of the base sample time.

**PCI Slot (-1:autosearch)** — If only one board of this type is physically present in the target PC, enter

-1

to automatically locate the board.

If two or more boards of this type are physically present in the target PC, enter the bus number and the PCI slot number of the board associated with this driver block. Use the format [BusNumber, SlotNumber]. To determine the bus number and the PCI slot number, type

```
getxpcpci
```

## PCI-6040E Pulse Generation

The inputs to the block should be a two element vector. The first element is the number of counts (of the 20 MHz source clock) that the counter should maintain at a low level, and the second element is the number of clock ticks for a high level. For example, to generate a pulsetrain at 1KHz with 25% low and 75% high, use the vector

```
[5000 15000]
```

### Driver Block Parameters

**Counter** — From the list, choose Counter 0, Counter 1, or Both to select the counter(s) to be used with this driver block. In each case, one block is needed for each physical board.

**Sample time** — Base sample time or a multiple of the base sample time.

**PCI slot (-1:autosearch)** — If only one board of this type is physically present in the target PC, enter

-1

to automatically locate the board.

If two or more boards of this type are physically present in the target PC, enter the bus number and the PCI slot number of the board associated with this driver block. Use the format [BusNumber, SlotNumber]. To determine the bus number and the PCI slot number, type

```
getxpcpci
```

## PCI-6040E Pulse Width/Period Measurement

### Driver Block Parameters

**Counter** — From the list, select a counter from 0 or 1.

**Trigger mode** — From the list, choose Level Triggered or Edge Triggered. See the table below for an example of how **Trigger mode** and **Polarity** affect one another. In this table, the data in the Output column resulted from a 1KHz pulse train with a 25% low and a 75% high pulse.

**Polarity** — From the list, choose Active low or Active high. See the table below for an example of how **Trigger mode** and **Polarity** affect one another. In this table, the data in the Output column resulted from a 1KHz pulse train with a 25% low and a 75% high pulse.

| Measurement objective    | Trigger mode    | Polarity    | Output |
|--------------------------|-----------------|-------------|--------|
| Pulse width (low pulse)  | Level Triggered | Active low  | 5000   |
| Pulse width (high pulse) | Level Triggered | Active High | 15000  |
| Period                   | Edge Triggered  | NA          | 20000  |

In every case, the output of the block is the number of clock ticks (of the 20MHz source clock) required for the specified measurement. When measuring pulse width, the output reflects the number of clock ticks for which the input signal was in the specified (low or high) state. See the table above for an example.

**Sample time** — Base sample time or a multiple of the base sample time.

**PCI slot (-1:autosearch)** — If only one board of this type is physically present in the target PC, enter

-1

to automatically locate the board.

If two or more boards of this type are physically present in the target PC, enter the bus number and the PCI slot number of the board associated with this driver block. Use the format [BusNumber, SlotNumber]. To determine the bus number and the PCI slot number, type

```
getxpcpci
```



## PCI/PXI-6052E

The PXI/PCI-6052E is an I/O board with 16 single or 8 differential analog input channels (16-bit) with a maximum sample rate of 333 kHz, 2 analog output channels (16-bit) and 8 digital input and output lines, and two counters/timers (24-bit) with a maximum source clock rate of 20 MHz.

xPC Target supports this board with these driver blocks:

- “PXI/PCI-6052E Analog Input (A/D)” on page 22-80
- “PXI/PCI-6052E Analog Output (D/A)” on page 22-82
- “PXI/PCI-6052E Digital Input” on page 22-84
- “PXI/PCI-6052E Digital Output” on page 22-85
- “PXI/PCI-6052E Pulse Generation” on page 22-86
- “PXI/PCI-6052E Pulse Width/Period Measurement” on page 22-87

### Board Characteristics

|                                 |                                                                                                         |
|---------------------------------|---------------------------------------------------------------------------------------------------------|
| Board name                      | PXI/PCI-6052E                                                                                           |
| Manufacturer                    | National Instruments                                                                                    |
| Bus type                        | PCI/PXI                                                                                                 |
| Access method                   | Memory mapped                                                                                           |
| Multiple block instance support | A/D: No, D/A: No, Digital I/O: Yes;<br>Period/Pulsewidth measurement: Yes;<br>Pulsetrain Generation: No |
| Multiple board support          | Yes                                                                                                     |

## PXI/PCI-6052E Analog Input (A/D)

### Scaling of Input to Output

| Hardware Input | Block Output Data Type | Scaling |
|----------------|------------------------|---------|
| volts          | Double                 | 1       |

### Driver Block Parameters

**Channel vector** — Enter numbers between 1 and 16. This driver allows you to enter channel numbers in any order.

For example, to use the first, second and fifth channels, enter

[1,2,5]

Number the channels beginning with 1 even if the board manufacturer starts numbering the channels with 0.

**Range vector** — Enter a range code for each of the channels in the channel vector. The range vector must be the same length as the channel vector. This driver allows each channel to be different.

The following table is a list of the ranges for this driver and the corresponding range codes.

| Input Range (V) | Range Code | Input Range (V) | Range Code |
|-----------------|------------|-----------------|------------|
| -10 to +10      | -10        | 0 - 10          | 10         |
| -5 to +5        | -5         | 0 - 5           | 5          |
| -2 to +2        | -2         | 0 - 2           | 2          |
| -1 to + 1       | -1         | 0 - 1           | 1          |
| -0.5 to +0.5    | -0.5       | 0 - 0.5         | 0.5        |
| -0.2 to +0.2    | -0.2       | 0 - 0.2         | 0.2        |

| Input Range (V) | Range Code | Input Range (V) | Range Code |
|-----------------|------------|-----------------|------------|
| -0.1 to +0.1    | -0.1       | 0 - 0.1         | 0.1        |
| -0.05 to +0.05  | -0.05      |                 |            |

For example, if the first channel is -10 to + 10 volts and the second and fifth channels are 0 to +1 volts, enter

[ -10, 1, 1]

**Input coupling vector** — Enter a coupling code for each of the channels in the channel vector. The coupling vector must be the same length as the channel vector. This driver allows a different coupling for each channel.

The following table is a list of the couplings for this driver and the corresponding coupling codes.

| Coupling | Coupling Code | Description                                                                                                                                                              |
|----------|---------------|--------------------------------------------------------------------------------------------------------------------------------------------------------------------------|
| RSE      | 0             | Analog input line connected to the positive input of the PGIA. Analog input ground (AIGND) internally connected to the negative input of the PGIA. See the board manual. |
| NRSE     | 1             | Analog input line connected to the positive input of the PGIA. Analog input sense (AISENSE) connected to the negative input of the PGIA. See the board manual.           |
| DIFF     | 2             | First analog input line connected to the positive input of the PGIA. Second analog input line connected to the negative input of the PGIA. See the board manual.         |

For example, if the first and second channels are single input and the fifth channel is a differential input, enter

[ 0, 0, 2]

The driver selects a second differential input 8 channels higher than the first channel. In the example above, the driver would select the thirteenth channel as a differential input with the fifth channel.

**Sample time** — Model base sample time or a multiple of the base sample time.

**PCI Slot (-1:autosearch)** — If only one board of this type is physically present in the target PC, enter

-1

to automatically locate the board.

If two or more boards of this type are physically present in the target PC, enter the bus number and the PCI slot number of the board associated with this driver block. Use the format [BusNumber, SlotNumber]. To determine the bus number and the PCI slot number, type

```
getxpcpci
```

## PXI/PCI-6052E Analog Output (D/A)

### Scaling of Input to Output

| Hardware Output | Block Input Data Type | Scaling |
|-----------------|-----------------------|---------|
| volts           | Double                | 1       |

### Driver Block Parameters

**Channel vector** — Enter 1 or 2. This driver allows the selection of individual D/A channels in any order. The number of elements defines the number of D/A channels used. For example, to use both of the analog output channels, enter

[1,2]

Number the channels begin with 1 even if the board manufacturer starts numbering the channels with 0.

**Range vector** — Enter a range code for each of the channels in the channel vector. The range vector must be the same length as the channel vector. This board allows the range of each channel to be different.

The following table is a list of the ranges for this driver and the corresponding range codes.

| <b>Input Range (V)</b> | <b>Range Code</b> | <b>Input Range (V)</b> | <b>Range Code</b> |
|------------------------|-------------------|------------------------|-------------------|
| -10 to +10 V           | -10               | 0 - 10 V               | 10                |

For example, if the first channel is -10 to +10 volts, and the second channel is 0 to 5 volts, enter

[ -10,5]

**Reset vector** — The reset vector controls the behavior of the channel at model termination. Enter a scalar or a vector that is the same length as the channel vector. If you specify a scalar value, that setting is used for all channels. If you specify a value of 1, the corresponding channel is reset to the value specified in the initial value vector. If you specify a value of 0, the channel remains at the last value attained while the model was running.

**Initial value vector** — The initial value vector contains the initial voltage values for the output channels. Enter a scalar or a vector that is the same length as the channel vector. If you specify a scalar value, that value is the initial value for all channels. The channels are set to the initial values between the time the model is downloaded and the time it is started.

**Sample time** — Base sample time or a multiple of the base sample time.

**PCI Slot (-1:autosearch)** — If only one board of this type is physically present in the target PC, enter

-1

to automatically locate the board.

If two or more boards of this type are physically present in the target PC, enter the bus number and the PCI slot number of the board associated with this driver block. Use the format [BusNumber, SlotNumber]. To determine the bus number and the PCI slot number, type

getxpcpci

## PXI/PCI-6052E Digital Input

### Scaling of Input to Output

| Hardware Input | Block Output Data Type | Scaling                         |
|----------------|------------------------|---------------------------------|
| TTL            | Double                 | TTL low = 0.0<br>TTL high = 1.0 |

### Driver Block Parameters

**Channel vector** — Enter numbers between 1 and 8 to select the digital input lines used with this port. This driver allows the selection of individual digital input lines in any order. The number of elements defines the number of digital lines used.

For example, to use all of the digital inputs for one port, enter

```
[1,2,3,4,5,6,7,8]
```

Number the lines beginning with 1 even if the board manufacturer starts numbering the lines with 0.

**Sample time** — Enter a base sample time or a multiple of the base sample time.

**PCI Slot (-1:autosearch)** — If only one board of this type is physically present in the target PC, enter

```
-1
```

to automatically locate the board.

If two or more boards of this type are physically present in the target PC, enter the bus number and the PCI slot number of the board associated with this driver block. Use the format [BusNumber, SlotNumber]. To determine the bus number and the PCI slot number, type

```
getxpcpci
```

## PXI/PCI-6052E Digital Output

### Scaling of Input to Output

| Hardware Output | Block Input Data Type | Scaling                           |
|-----------------|-----------------------|-----------------------------------|
| TTL             | Double                | <0.5 = TTL low<br>≥0.5 = TTL high |

### Driver Block Parameters

**Channel vector** — Enter numbers between 1 and 8 to select the digital output lines used with this port. This driver allows the selection of individual digital output lines in any order. The number of elements defines the number of digital lines used.

For example, to use all of the digital outputs for one port, enter

```
[1,2,3,4,5,6,7,8]
```

Number the lines beginning with 1 even if the board manufacturer starts numbering the lines with 0.

**Reset vector** — The reset vector controls the behavior of the channel at model termination. Enter a scalar or a vector that is the same length as the channel vector. If you specify a scalar value, that setting is used for all channels. If you specify a value of 1, the corresponding channel is reset to the value specified in the initial value vector. If you specify a value of 0, the channel remains at the last value attained while the model was running.

**Initial value vector** — The initial value vector contains the initial values (0 or 1) of the output channels. Enter a scalar or a vector that is the same length as the channel vector. If you enter a scalar, that value is used for all channels. The channels are set to these initial values between the time the model is downloaded and the time it is started.

**Sample time** — Enter a base sample time or a multiple of the base sample time.

**PCI Slot (-1:autosearch)** — If only one board of this type is physically present in the target PC, enter

```
-1
```

to automatically locate the board.

If two or more boards of this type are physically present in the target PC, enter the bus number and the PCI slot number of the board associated with this driver block. Use the format [BusNumber, SlotNumber]. To determine the bus number and the PCI slot number, type

```
getxpcpci
```

## **PXI/PCI-6052E Pulse Generation**

The inputs to the block should be a two element vector. The first element is the number of counts (of the 20 MHz source clock) that the counter should maintain at a low level, and the second element is the number of clock ticks for a high level. For example, to generate a pulsetrain at 1KHz with 25% low and 75% high, use the vector

```
[5000 15000]
```

### **Driver Block Parameters**

**Counter** — From the list, choose Counter 0, Counter 1, or Both to select the counter(s) to be used with this driver block. In each case, one block is needed for each physical board.

**Sample time** — Base sample time or a multiple of the base sample time.

**PCI slot (-1:autosearch)** — If only one board of this type is physically present in the target PC, enter

```
-1
```

to automatically locate the board.

If two or more boards of this type are physically present in the target PC, enter the bus number and the PCI slot number of the board associated with this driver block. Use the format [BusNumber, SlotNumber]. To determine the bus number and the PCI slot number, type

```
getxpcpci
```



## PXI/PCI-6052E Pulse Width/Period Measurement

### Driver Block Parameters

**Counter** — From the list, select a counter from 0 or 1.

**Trigger mode** — From the list, choose Level Triggered or Edge Triggered. See the table below for an example of how **Trigger mode** and **Polarity** affect one another. In this table, the data in the Output column resulted from a 1KHz pulse train with a 25% low and a 75% high pulse.

**Polarity** — From the list, choose Active low or Active high. See the table below for an example of how **Trigger mode** and **Polarity** affect one another. In this table, the data in the Output column resulted from a 1KHz pulse train with a 25% low and a 75% high pulse.

| Measurement objective    | Trigger mode    | Polarity    | Output |
|--------------------------|-----------------|-------------|--------|
| Pulse width (low pulse)  | Level Triggered | Active low  | 5000   |
| Pulse width (high pulse) | Level Triggered | Active High | 15000  |
| Period                   | Edge Triggered  | NA          | 20000  |

In every case, the output of the block is the number of clock ticks (of the 20MHz source clock) required for the specified measurement. When measuring pulse width, the output reflects the number of clock ticks for which the input signal was in the specified (low or high) state. See the table above for an example.

**Sample time** — Base sample time or a multiple of the base sample time.

**PCI slot (-1:autosearch)** — If only one board of this type is physically present in the target PC, enter

-1

to automatically locate the board.

If two or more boards of this type are physically present in the target PC, enter the bus number and the PCI slot number of the board associated with this driver block. Use the format [BusNumber, SlotNumber]. To determine the bus number and the PCI slot number, type

```
getxpcpci
```

## PCI-6070E (Formerly PCI-MIO-16E-1)

The PCI-6070E is an I/O board with 16 single or 8 differential analog input channels (12-bit) with a maximum sample rate of 1.25 MHz, 2 analog output channels (12-bit), 8 digital input and output lines, and 2 counter/timers (24-bit) with a maximum source clock rate of 20 MHz.

xPC Target supports this board with these driver blocks:

- “PCI-6070E Analog Input (A/D)” on page 22-90
- “PCI-6070E Analog Output (D/A)” on page 22-92
- “PCI-6070E Digital Input” on page 22-94
- “PCI-6070E Digital Output” on page 22-95
- “PCI-6070E Pulse Generation” on page 22-96
- “PCI-6070E Pulse Width/Period Measurement” on page 22-97

### Board Characteristics

|                                 |                                                                                                         |
|---------------------------------|---------------------------------------------------------------------------------------------------------|
| Board name                      | PCI-6070E                                                                                               |
| Manufacturer                    | National Instruments                                                                                    |
| Bus type                        | PCI                                                                                                     |
| Access method                   | Memory mapped                                                                                           |
| Multiple block instance support | A/D: No, D/A: No, Digital I/O: Yes;<br>Period/Pulsewidth measurement: Yes;<br>Pulsetrain Generation: No |
| Multiple board support          | Yes                                                                                                     |

## PCI-6070E Analog Input (A/D)

### Scaling Input to Output

| Hardware Input | Block Output Data Type | Scaling |
|----------------|------------------------|---------|
| volts          | Double                 | 1       |

### Driver Block Parameters

**Channel vector** — Enter numbers between 1 and 16. This driver allows you to enter channel numbers in any order.

For example, to use the first, second and fifth channels, enter

[1,2,5]

Number the channels beginning with 1 even if the board manufacturer starts numbering the channels with 0.

**Range vector** — Enter a range code for each of the channels in the channel vector. The range vector must be the same length as the channel vector. This driver allows each channel to be different.

The following table is a list of the ranges for this driver and the corresponding range codes.

| Input Range (V) | Range Code | Input Range (V) | Range Code |
|-----------------|------------|-----------------|------------|
| -10 to +10      | -10        | 0 - 10          | 10         |
| -5 to +5        | -5         | 0 - 5           | 5          |
| -2 to +2        | -2         | 0 - 2           | 2          |
| -1 to + 1       | -1         | 0 - 1           | 1          |
| -0.5 to +0.5    | -0.5       | 0 - 0.5         | 0.5        |
| -0.2 to +0.2    | -0.2       | 0 - 0.2         | 0.2        |

| Input Range (V) | Range Code | Input Range (V) | Range Code |
|-----------------|------------|-----------------|------------|
| -0.1 to +0.1    | -0.1       | 0 - 0.1         | 0.1        |
| -0.05 to +0.05  | -0.05      |                 |            |

For example, if the first channel is -10 to + 10 volts and the second and fifth channels are 0 to +1 volts, enter

[ -10, 1, 1]

**Input coupling vector** — Enter a coupling code for each of the channels in the channel vector. The coupling vector must be the same length as the channel vector. This driver allows a different coupling for each channel.

The following table is a list of the couplings for this driver and the corresponding coupling codes.

| Coupling | Coupling Code | Description                                                                                                                                                              |
|----------|---------------|--------------------------------------------------------------------------------------------------------------------------------------------------------------------------|
| RSE      | 0             | Analog input line connected to the positive input of the PGIA. Analog input ground (AIGND) internally connected to the negative input of the PGIA. See the board manual. |
| NRSE     | 1             | Analog input line connected to the positive input of the PGIA. Analog input sense (AISENSE) connected to the negative input of the PGIA. See the board manual.           |
| DIFF     | 2             | First analog input line connected to the positive input of the PGIA. Second analog input line connected to the negative input of the PGIA. See the board manual.         |

For example, if the first and second channels are single input and the fifth channel is a differential input, enter

[ 0, 0, 2]

The driver selects a second differential input 8 channels higher than the first channel. In the example above, the driver would select the thirteenth channel as a differential input with the fifth channel.

**Sample time** — Model base sample time or a multiple of the base sample time.

**PCI Slot (-1:autosearch)** — If only one board of this type is physically present in the target PC, enter

-1

to automatically locate the board.

If two or more boards of this type are physically present in the target PC, enter the bus number and the PCI slot number of the board associated with this driver block. Use the format [BusNumber, SlotNumber]. To determine the bus number and the PCI slot number, type

```
getxpcpci
```

## PCI-6070E Analog Output (D/A)

### Scaling Input to Output

| Hardware Output | Block Input Data Type | Scaling |
|-----------------|-----------------------|---------|
| volts           | Double                | 1       |

### Driver Block Parameters

**Channel vector** — Enter 1 or 2. This driver allows the selection of individual D/A channels in any order. The number of elements defines the number of D/A channels used. For example, to use both of the analog output channels, enter

```
[1,2]
```

Number the channels beginning with 1 even if the board manufacturer starts numbering the channels with 0.

**Range vector** — Enter a range code for each of the channels in the channel vector. The range vector must be the same length as the channel vector. This board allows the range of each channel to be different.

The following table is a list of the ranges for this driver and the corresponding range codes.

| <b>Input Range (V)</b> | <b>Range Code</b> | <b>Input Range (V)</b> | <b>Range Code</b> |
|------------------------|-------------------|------------------------|-------------------|
| -10 to +10             | -10               | 0 - 10                 | 10                |

For example, if the first channel is -10 to +10 volts, and the second channel is 0 to 5 volts, enter

```
[ -10,5]
```

**Reset vector** — The reset vector controls the behavior of the channel at model termination. Enter a scalar or a vector that is the same length as the channel vector. If you specify a scalar value, that setting is used for all channels. If you specify a value of 1, the corresponding channel is reset to the value specified in the initial value vector. If you specify a value of 0, the channel remains at the last value attained while the model was running.

**Initial value vector** — The initial value vector contains the initial voltage values for the output channels. Enter a scalar or a vector that is the same length as the channel vector. If you specify a scalar value, that value is the initial value for all channels. The channels are set to the initial values between the time the model is downloaded and the time it is started.

**Sample time** — Base sample time or a multiple of the base sample time.

**PCI Slot (-1:autosearch)** — If only one board of this type is physically present in the target PC, enter

```
-1
```

to automatically locate the board.

If two or more boards of this type are physically present in the target PC, enter the bus number and the PCI slot number of the board associated with this driver block. Use the format [BusNumber, SlotNumber]. To determine the bus number and the PCI slot number, type

```
getxpcpci
```

## PCI-6070E Digital Input

### Scaling Input to Output

| Hardware Input | Block Output Data Type | Scaling                         |
|----------------|------------------------|---------------------------------|
| TTL            | Double                 | TTL low = 0.0<br>TTL high = 1.0 |

### Driver Block Parameters

**Channel vector** — Enter numbers between 1 and 8 to select the digital input lines used with this port. This driver allows the selection of individual digital input lines in any order. The number of elements defines the number of digital lines used.

For example, to use all of the digital inputs for one port, enter

```
[ 1, 2, 3, 4, 5, 6, 7, 8]
```

Number the lines beginning with 1 even if the board manufacturer starts numbering the lines with 0.

**Sample time** — Enter a base sample time or a multiple of the base sample time.

**PCI Slot (-1:autosearch)** — If only one board of this type is physically present in the target PC, enter

```
- 1
```

to automatically locate the board.

If two or more boards of this type are physically present in the target PC, enter the bus number and the PCI slot number of the board associated with this driver block. Use the format [BusNumber, SlotNumber]. To determine the bus number and the PCI slot number, type

```
getxpcpci
```



## PCI-6070E Digital Output

### Scaling Input to Output

| Hardware Output | Block Input Data Type | Scaling                             |
|-----------------|-----------------------|-------------------------------------|
| TTL             | Double                | < 0.5 = TTL low<br>≥ 0.5 = TTL high |

### Driver Block Parameters

**Channel vector** — Enter numbers between 1 and 8 to select the digital output lines used with this port. This driver allows the selection of individual digital output lines in any order. The number of elements defines the number of digital lines used.

For example, to use all of the digital outputs for one port, enter

```
[1,2,3,4,5,6,7,8]
```

Number the lines beginning with 1 even if the board manufacturer starts numbering the lines with 0.

**Reset vector** — The reset vector controls the behavior of the channel at model termination. Enter a scalar or a vector that is the same length as the channel vector. If you specify a scalar value, that setting is used for all channels. If you specify a value of 1, the corresponding channel is reset to the value specified in the initial value vector. If you specify a value of 0, the channel remains at the last value attained while the model was running.

**Initial value vector** — The initial value vector contains the initial values (0 or 1) of the output channels. Enter a scalar or a vector that is the same length as the channel vector. If you enter a scalar, that value is used for all channels. The channels are set to these initial values between the time the model is downloaded and the time it is started.

**Sample time** — Enter a base sample time or a multiple of the base sample time.

**PCI Slot (-1:autosearch)** — If only one board of this type is physically present in the target PC, enter

```
-1
```

to automatically locate the board.

If two or more boards of this type are physically present in the target PC, enter the bus number and the PCI slot number of the board associated with this driver block. Use the format [BusNumber, SlotNumber]. To determine the bus number and the PCI slot number, type

```
getxpcpci
```

## **PCI-6070E Pulse Generation**

The inputs to the block should be a two element vector. The first element is the number of counts (of the 20 MHz source clock) that the counter should maintain at a low level, and the second element is the number of clock ticks for a high level. For example, to generate a pulsetrain at 1KHz with 25% low and 75% high, use the vector

```
[5000 15000]
```

### **Driver Block Parameters**

**Counter** — From the list, choose Counter 0, Counter 1, or Both to select the counter(s) to be used with this driver block. In each case, one block is needed for each physical board.

**Sample time** — Base sample time or a multiple of the base sample time.

**PCI slot (-1:autosearch)** — If only one board of this type is physically present in the target PC, enter

```
-1
```

to automatically locate the board.

If two or more boards of this type are physically present in the target PC, enter the bus number and the PCI slot number of the board associated with this driver block. Use the format [BusNumber, SlotNumber]. To determine the bus number and the PCI slot number, type

```
getxpcpci
```

## PCI-6070E Pulse Width/Period Measurement

### Driver Block Parameters

**Counter** — From the list, select a counter from 0 or 1.

**Trigger mode** — From the list, choose Level Triggered or Edge Triggered. See the table below for an example of how **Trigger mode** and **Polarity** affect one another. In this table, the data in the Output column resulted from a 1KHz pulse train with a 25% low and a 75% high pulse.

**Polarity** — From the list, choose Active low or Active high. See the table below for an example of how **Trigger mode** and **Polarity** affect one another. In this table, the data in the Output column resulted from a 1KHz pulse train with a 25% low and a 75% high pulse.

| Measurement objective    | Trigger mode    | Polarity    | Output |
|--------------------------|-----------------|-------------|--------|
| Pulse width (low pulse)  | Level Triggered | Active low  | 5000   |
| Pulse width (high pulse) | Level Triggered | Active High | 15000  |
| Period                   | Edge Triggered  | NA          | 20000  |

In every case, the output of the block is the number of clock ticks (of the 20MHz source clock) required for the specified measurement. When measuring pulse width, the output reflects the number of clock ticks for which the input signal was in the specified (low or high) state. See the table above for an example.

**Sample time** — Base sample time or a multiple of the base sample time.

**PCI slot (-1:autosearch)** — If only one board of this type is physically present in the target PC, enter

-1

to automatically locate the board.

If two or more boards of this type are physically present in the target PC, enter the bus number and the PCI slot number of the board associated with this driver block. Use the format [BusNumber, SlotNumber]. To determine the bus number and the PCI slot number, type

```
getxpcpci
```

## PCI-6071E

The PCI-6071E is an I/O board with 64 single or 32 differential analog input (A/D) channels (12-bit) with a maximum sample rate of 1.25 MHz, 2 analog output (D/A) channels (12-bit), 8 digital input and output lines, and 2 counter/timers (24-bit) with a maximum source clock rate of 20 MHz.

xPC Target supports this board with these driver blocks:

- “PCI-6071E Analog Input (A/D)” on page 22-100
- “PCI-6071E Analog Output (D/A)” on page 22-102
- “PCI-6071E Digital Input” on page 22-104
- “PCI-6071E Digital Output” on page 22-105
- “PCI-6071E Pulse Generation” on page 22-106
- “PCI-6071E Pulse Width/Period Measurement” on page 22-107

### Board Characteristics

|                                 |                                                                                                         |
|---------------------------------|---------------------------------------------------------------------------------------------------------|
| Board Name                      | PCI-6071E                                                                                               |
| Manufacturer                    | National Instruments                                                                                    |
| Bus type                        | PCI                                                                                                     |
| Access method                   | Memory mapped                                                                                           |
| Multiple block instance support | A/D: No, D/A: No, Digital I/O: Yes;<br>Period/Pulsewidth measurement: Yes;<br>Pulsetrain Generation: No |
| Multiple board support          | Yes                                                                                                     |

## PCI-6071E Analog Input (A/D)

### Scaling Input to Output

| Hardware Input | Block Output Data Type | Scaling |
|----------------|------------------------|---------|
| volts          | Double                 | 1       |

### Driver Block Parameters

**Channel vector** — Enter numbers between 1 and 64. This driver allows you to enter channel numbers in any order.

For example, to use the first, second, and fifth channels, enter

[1,2,5]

Number the channels beginning with 1 even if the board manufacturer starts numbering the channels with 0.

**Range vector** — Enter a range code for each of the channels in the channel vector. The range vector must be the same length as the channel vector. This driver allows each channel to be different.

The following table is a list of the ranges for this driver and the corresponding range codes.

| Input Range (V) | Range Code | Input Range (V) | Range Code |
|-----------------|------------|-----------------|------------|
| -10 to +10      | -10        | 0 to +10        | 10         |
| -5 to +5        | -5         | 0 to +5         | 5          |
| -2 to +2        | -2         | 0 to +2         | 2          |
| -1 to +1        | -1         | 0 to +1         | 1          |
| -0.5 to +0.5    | -0.5       | 0 to +0.5       | 0.5        |
| -0.2 to +0.2    | -0.2       | 0 to +0.2       | 0.2        |

| Input Range (V) | Range Code | Input Range (V) | Range Code |
|-----------------|------------|-----------------|------------|
| -0.1 to +0.1    | -0.1       | 0 to +0.1       | 0.1        |
| -0.05 to +0.05  | -0.05      |                 |            |

For example, if the first channel is -10 to + 10 volts and the second and fifth channels are 0 to +1 volts, enter

[ -10, 1, 1]

**Input coupling vector** — Enter a coupling code for each of the channels in the channel vector. The coupling vector must be the same length as the channel vector. This driver allows a different coupling for each channel.

The following table is a list of the couplings for this driver and the corresponding coupling codes.

| Coupling | Coupling Code | Description                                                                                                                                                              |
|----------|---------------|--------------------------------------------------------------------------------------------------------------------------------------------------------------------------|
| RSE      | 0             | Analog input line connected to the positive input of the PGIA. Analog input ground (AIGND) internally connected to the negative input of the PGIA. See the board manual. |
| NRSE     | 1             | Analog input line connected to the positive input of the PGIA. Analog input sense (AISENSE) connected to the negative input of the PGIA. See the board manual.           |
| DIFF     | 2             | First analog input line connected to the positive input of the PGIA. Second analog input line connected to the negative input of the PGIA. See the board manual.         |

For example, if the first and second channels are single input and the fifth channel is a differential input, enter

[0, 0, 2]

The driver selects a second differential input 8 channels higher than the first channel. In the example above, the driver would select the thirteenth channel as a differential input with the fifth channel.

**Sample time** — Model base sample time or a multiple of the base sample time.

**PCI Slot (-1:autosearch)** — If only one board of this type is physically present in the target PC, enter

-1

to automatically locate the board.

If two or more boards of this type are physically present in the target PC, enter the bus number and the PCI slot number of the board associated with this driver block. Use the format [BusNumber, SlotNumber]. To determine the bus number and the PCI slot number, type

```
getxpcpci
```

## PCI-6071E Analog Output (D/A)

### Scaling Input to Output

| Hardware Output | Block Input Data Type | Scaling |
|-----------------|-----------------------|---------|
| volts           | Double                | 1       |

### Driver Block Parameters

**Channel vector** — Enter 1 or 2. This driver allows the selection of individual D/A channels in any order. The number of elements defines the number of D/A channels used. For example, to use both of the analog output channels, enter

[1,2]

Number the channels beginning with 1 even if the board manufacturer starts numbering the channels with 0.

**Range vector** — Enter a range code for each of the channels in the channel vector. The range vector must be the same length as the channel vector. This board allows the range of each channel to be different.



The following table is a list of the ranges for this driver and the corresponding range codes.

| <b>Input Range (V)</b> | <b>Range Code</b> | <b>Input Range (V)</b> | <b>Range Code</b> |
|------------------------|-------------------|------------------------|-------------------|
| -10 to +10             | -10               | 0 - 10                 | 10                |

For example, if the first channel is -10 to +10 volts, and the second channel is 0 to 5 volts, enter

```
[ -10,5]
```

**Reset vector** — The reset vector controls the behavior of the channel at model termination. Enter a scalar or a vector that is the same length as the channel vector. If you specify a scalar value, that setting is used for all channels. If you specify a value of 1, the corresponding channel is reset to the value specified in the initial value vector. If you specify a value of 0, the channel remains at the last value attained while the model was running.

**Initial value vector** — The initial value vector contains the initial voltage values for the output channels. Enter a scalar or a vector that is the same length as the channel vector. If you specify a scalar value, that value is the initial value for all channels. The channels are set to the initial values between the time the model is downloaded and the time it is started.

**Sample time** — Base sample time or a multiple of the base sample time.

**PCI Slot (-1:autosearch)** — If only one board of this type is physically present in the target PC, enter

```
-1
```

to automatically locate the board.

If two or more boards of this type are physically present in the target PC, enter the bus number and the PCI slot number of the board associated with this driver block. Use the format [BusNumber, SlotNumber]. To determine the bus number and the PCI slot number, type

```
getxpcpci
```

## PCI-6071E Digital Input

### Scaling Input to Output

| Hardware Input | Block Output Data Type | Scaling                         |
|----------------|------------------------|---------------------------------|
| TTL            | Double                 | TTL low = 0.0<br>TTL high = 1.0 |

### Driver Block Parameters

**Channel vector** — Enter numbers between 1 and 8 to select the digital input lines used with this port. This driver allows the selection of individual digital input lines in any order. The number of elements defines the number of digital lines used.

For example, to use all of the digital inputs for one port, enter

```
[1,2,3,4,5,6,7,8]
```

Number the lines beginning with 1 even if the board manufacturer starts numbering the lines with 0.

**Sample time** — Enter a base sample time or a multiple of the base sample time.

**PCI Slot (-1:autosearch)** — If only one board of this type is physically present in the target PC, enter

```
-1
```

to automatically locate the board.

If two or more boards of this type are physically present in the target PC, enter the bus number and the PCI slot number of the board associated with this driver block. Use the format [BusNumber, SlotNumber]. To determine the bus number and the PCI slot number, type

```
getxpcpci
```

## PCI-6071E Digital Output

### Scaling Input to Output

| Hardware Output | Block Input Data Type | Scaling                             |
|-----------------|-----------------------|-------------------------------------|
| TTL             | Double                | < 0.5 = TTL low<br>≥ 0.5 = TTL high |

### Driver Block Parameters

**Channel vector** — Enter numbers between 1 and 8 to select the digital output lines used with this port. This driver allows the selection of individual digital output lines in any order. The number of elements defines the number of digital lines used.

For example, to use all of the digital outputs for one port, enter

```
[1,2,3,4,5,6,7,8]
```

Number the lines beginning with 1 even if the board manufacturer starts numbering the lines with 0.

**Reset vector** — The reset vector controls the behavior of the channel at model termination. Enter a scalar or a vector that is the same length as the channel vector. If you specify a scalar value, that setting is used for all channels. If you specify a value of 1, the corresponding channel is reset to the value specified in the initial value vector. If you specify a value of 0, the channel remains at the last value attained while the model was running.

**Initial value vector** — The initial value vector contains the initial values (0 or 1) of the output channels. Enter a scalar or a vector that is the same length as the channel vector. If you enter a scalar, that value is used for all channels. The channels are set to these initial values between the time the model is downloaded and the time it is started.

**Sample time** — Enter a base sample time or a multiple of the base sample time.

**PCI Slot (-1:autosearch)** — If only one board of this type is physically present in the target PC, enter

-1

to automatically locate the board.

If two or more boards of this type are physically present in the target PC, enter the bus number and the PCI slot number of the board associated with this driver block. Use the format [BusNumber, SlotNumber]. To determine the bus number and the PCI slot number, type

```
getxpcpci
```

## PCI-6071E Pulse Generation

The inputs to the block should be a two element vector. The first element is the number of counts (of the 20 MHz source clock) that the counter should maintain at a low level, and the second element is the number of clock ticks for a high level. For example, to generate a pulsetrain at 1KHz with 25% low and 75% high, use the vector

```
[5000 15000]
```

### Driver Block Parameters

**Counter** — From the list, choose Counter 0, Counter 1, or Both to select the counter(s) to be used with this driver block. In each case, one block is needed for each physical board.

**Sample time** — Base sample time or a multiple of the base sample time.

**PCI slot (-1:autosearch)** — If only one board of this type is physically present in the target PC, enter

-1

to automatically locate the board.

If two or more boards of this type are physically present in the target PC, enter the bus number and the PCI slot number of the board associated with this driver block. Use the format [BusNumber, SlotNumber]. To determine the bus number and the PCI slot number, type

```
getxpcpci
```

## PCI-6071E Pulse Width/Period Measurement

### Driver Block Parameters

**Counter** — From the list, select a counter from 0 or 1.

**Trigger mode** — From the list, choose Level Triggered or Edge Triggered. See the table below for an example of how **Trigger mode** and **Polarity** affect one another. In this table, the data in the Output column resulted from a 1KHz pulse train with a 25% low and a 75% high pulse.

**Polarity** — From the list, choose Active low or Active high. See the table below for an example of how **Trigger mode** and **Polarity** affect one another. In this table, the data in the Output column resulted from a 1KHz pulse train with a 25% low and a 75% high pulse.

| Measurement objective    | Trigger mode    | Polarity    | Output |
|--------------------------|-----------------|-------------|--------|
| Pulse width (low pulse)  | Level Triggered | Active low  | 5000   |
| Pulse width (high pulse) | Level Triggered | Active High | 15000  |
| Period                   | Edge Triggered  | NA          | 20000  |

In every case, the output of the block is the number of clock ticks (of the 20MHz source clock) required for the specified measurement. When measuring pulse width, the output reflects the number of clock ticks for which the input signal was in the specified (low or high) state. See the table above for an example.

**Sample time** — Base sample time or a multiple of the base sample time.

**PCI slot (-1:autosearch)** — If only one board of this type is physically present in the target PC, enter

-1

to automatically locate the board.

If two or more boards of this type are physically present in the target PC, enter the bus number and the PCI slot number of the board associated with this driver block. Use the format [BusNumber, SlotNumber]. To determine the bus number and the PCI slot number, type

```
getxpcpci
```

## PCI-6503

The PCI-6503 is an I/O board with 24 digital input and output lines. xPC Target supports this board with these driver blocks:

- “PCI-6503 Digital Input” on page 22-109
- “PCI-6503 Digital Output” on page 22-110

### Board Characteristics

|                                 |                      |
|---------------------------------|----------------------|
| Board name                      | PCI-6503             |
| Manufacturer                    | National Instruments |
| Bus type                        | PCI                  |
| Access method                   | I/O mapped           |
| Multiple block instance support | Yes                  |
| Multiple board support          | Yes                  |

### PCI-6503 Digital Input

The PCI-6503 has one 8255 chip with 3 ports (A,B,C). Each port has a maximum of 8 digital I/O lines that can be configured as inputs or outputs.

Use a separate driver block for each port. By selecting the digital input driver block, the port is configured as input.

### Scaling of Input to Output

| Hardware Input | Block Output Data Type | Scaling                         |
|----------------|------------------------|---------------------------------|
| TTL            | Double                 | TTL low = 0.0<br>TTL high = 1.0 |

### Driver Block Parameters

**Channel vector** — Enter numbers between 1 and 8 to select the digital input lines used with this port. This driver allows the selection of individual digital input lines in any order. The number of elements defines the number of digital lines used.

For example, to use all of the digital inputs for one port, enter

```
[1,2,3,4,5,6,7,8]
```

Number the lines beginning with 1 even if the board manufacturer starts numbering the lines with 0.

**Port** — From the list choose either A, B, or C. The I/O board has a 8255 chip with 3 ports. The **Port** parameter defines which port of the 8255 chip is used for this driver block. Each port has a maximum of 8 digital lines that can be configured as inputs or outputs depending on which driver block is chosen. In each case, one block is needed for each port.

**Sample time** — Enter a base sample time or a multiple of the base sample time.

**PCI Slot (-1:autosearch)** — If only one board of this type is physically present in the target PC, enter

```
-1
```

to automatically locate the board.

If two or more boards of this type are physically present in the target PC, enter the bus number and the PCI slot number of the board associated with this driver block. Use the format [BusNumber, SlotNumber]. To determine the bus number and the PCI slot number, type

```
getxpcpci
```

### PCI-6503 Digital Output

The PCI-6503 has one 8255 chip with 3 ports (A,B,C). Each port has a maximum of 8 digital I/O lines that can be configured as inputs or outputs.

Use a separate driver block for each port. By selecting the digital output driver block, the port is configured as output.



## Scaling of Input to Output

| Hardware Output | Block Input Data Type | Scaling                             |
|-----------------|-----------------------|-------------------------------------|
| TTL             | Double                | < 0.5 = TTL low<br>≥ 0.5 = TTL high |

### Driver Block Parameters

**Channel vector** — Enter numbers between 1 and 8 to select the digital output lines used with this port. This driver allows the selection of individual digital output lines in any order. The number of elements defines the number of digital lines used.

For example, to use all of the digital outputs for one port, enter

```
[1,2,3,4,5,6,7,8]
```

Number the lines beginning with 1 even if the board manufacturer starts numbering the lines with 0.

**Port** — From the list choose either A, B, or C. The I/O board has a 8255 chip with 3 ports. The **Port** parameter defines which port of the 8255 chip is used for this driver block. Each port has a maximum of 8 digital lines that can be configured as inputs or outputs depending on which driver block is chosen. In each case, one block is needed for each port.

**Reset vector** — The reset vector controls the behavior of the channel at model termination. Enter a scalar or a vector that is the same length as the channel vector. If you specify a scalar value, that setting is used for all channels. If you specify a value of 1, the corresponding channel is reset to the value specified in the initial value vector. If you specify a value of 0, the channel remains at the last value attained while the model was running.

**Initial value vector** — The initial value vector contains the initial values (0 or 1) of the output channels. Enter a scalar or a vector that is the same length as the channel vector. If you enter a scalar, that value is used for all channels. The channels are set to these initial values between the time the model is downloaded and the time it is started.

**Sample time** — Enter a base sample time or a multiple of the base sample time.

**PCI Slot (-1:autosearch)** — If only one board of this type is physically present in the target PC, enter

-1

to automatically locate the board.

If two or more boards of this type are physically present in the target PC, enter the bus number and the PCI slot number of the board associated with this driver block. Use the format [BusNumber, SlotNumber]. To determine the bus number and the PCI slot number, type

`getxpcpci`

## PCI-6527

The PCI-6527 is an I/O board with 24 filtered digital input lines and 24 digital output lines. You can individually turn input filtering on or off for each of the 24 input lines. However, there is only one filter time of all of the input lines that have filtering enabled.

xPC Target supports this board with these driver blocks:

- “PCI-6527 Digital Input” on page 22-113
- “PCI-6527 Digital Output” on page 22-115

### Board Characteristics

|                                 |                      |
|---------------------------------|----------------------|
| Board name                      | PCI-6527             |
| Manufacturer                    | National Instruments |
| Bus type                        | PCI                  |
| Access method                   | Memory mapped        |
| Multiple block instance support | Digital I/O: Yes     |
| Multiple board support          | Yes                  |

### PCI-6527 Digital Input

The PCI-6527 has one chip with 3 ports (A,B,C) for digital input. Each port has a maximum of 8 digital I/O lines. Use a separate driver block for each port.

---

**Note** The interrupt on change capability of this board is not used.

---

### Scaling of Input to Output

| Hardware Input | Block Input Data Type | Scaling                       |
|----------------|-----------------------|-------------------------------|
| OPTO           | Double                | $< 0.5 = 0$<br>$\geq 0.5 = 1$ |

### Driver Block Parameters

**Channel vector** — Enter numbers between 1 and 8 to select the digital input lines used with this port. This driver allows the selection of individual digital input lines in any order. The number of elements defines the number of digital lines used.

For example, to use all of the digital inputs for one port, enter

```
[1,2,3,4,5,6,7,8]
```

Number the lines beginning with 1 even though the board manufacturer starts numbering the lines with 0.

**Port** — From the list choose either A, B, or C. The **Port** parameter defines which port is used for this driver block. Each port has a maximum of 8 digital inputs. In each case, one block is needed for each port.

The documentation for this board from National Instruments labels these ports 0, 1, and 2.

**Filter vector** — This is a Boolean vector that selects which input lines to filter. For example, if you enter a **Channel vector** of [1,3,5], and you want to filter all three lines, enter

```
[1,1,1]
```

If you want to filter lines 1 and 5, but not line 3, then enter

```
[1,0,1]
```

If the filter vector is a single element, then it is scalar expanded to the same width as the **Channel vector**. In the example above, if the **Filter vector** is [0], it is expanded to [0,0,0]. Likewise, if the **Filter vector** is [1] it is expanded to [1,1,1].

**Filter interval** — Enter the time interval the hardware filter uses to determine a stable pulse. If the input pulse is shorter than this interval, it is ignored. There is only one filter interval for all filtered inputs, and if you filter on more than one digital input block for this board, you must enter the same **Filter interval** for all blocks.

A reasonable value for the **Filter interval** would be 200 to 300 us.

**Sample time** — Enter a base sample time or a multiple of the base sample time.

**PCI Slot (-1:autosearch)** — If only one board of this type is physically present in the target PC, enter

-1

to automatically locate the board.

If two or more boards of this type are physically present in the target PC, enter the bus number and the PCI slot number of the board associated with this driver block. Use the format [BusNumber, SlotNumber]. To determine the bus number and the PCI slot number, type

```
getxpcpci
```

## PCI-6527 Digital Output

The PCI-6527 has one chip with 3 ports (A,B,C) for digital output. Each port has a maximum of 8 digital output lines. Use a separate driver block for each port.

### Scaling of Input to Output

| Hardware Output | Block Output Data Type | Scaling                                                                       |
|-----------------|------------------------|-------------------------------------------------------------------------------|
| OPTO            | Double                 | <0.5 = OPTO is OFF, no current flowing<br>≥0.5 = OPTO is ON, current can flow |

### Driver Block Parameters

**Channel vector** — Enter numbers between 1 and 8 to select the digital output lines used with this port. This driver allows the selection of individual digital output lines in any order. The number of elements defines the number of digital lines used.

For example, to use all of the digital outputs for one port, enter

```
[1,2,3,4,5,6,7,8]
```

Number the lines beginning with 1 even though the board manufacturer starts numbering the lines with 0.

**Port** — From the list choose either A, B, or C. The **Port** parameter defines which port is used for this driver block. Each port has a maximum of 8 digital output lines. In each case, one block is needed for each port.

The documentation for this board from National Instruments labels these ports 3, 4, and 5.

**Reset vector** — The reset vector controls the behavior of the channel at model termination. Enter a scalar or a vector that is the same length as the channel vector. If you specify a scalar value, that setting is used for all channels. If you specify a value of 1, the corresponding channel is reset to the value specified in the initial value vector. If you specify a value of 0, the channel remains at the last value attained while the model was running.

**Initial value vector** — The initial value vector contains the initial voltage values for the output channels. Enter a scalar or a vector that is the same length as the channel vector. If you specify a scalar value, that value is the initial value for all channels. The channels are set to the initial values between the time the model is downloaded and the time it is started.

**Sample time** — Enter a base sample time or a multiple of the base sample time.

**PCI Slot (-1:autosearch)** — If only one board of this type is physically present in the target PC, enter

-1

to automatically locate the board.

If two or more boards of this type are physically present in the target PC, enter the bus number and the PCI slot number of the board associated with this driver block. Use the format [BusNumber, SlotNumber]. To determine the bus number and the PCI slot number, type

```
getxpcpci
```

## PCI-6601

The National Instruments PCI-6601 is a general purpose counter/timer board. It has four 32-bit counter channels. The reference frequency for this board is 20 MHz.

xPC Target supports this board with the following driver blocks:

- “PCI-6601 Digital Input” on page 22-117
- “PCI-6601 Digital Output” on page 22-118
- “PCI-6601 Incremental Encoder” on page 22-120
- “PCI-6601 Pulse Generation” on page 22-121
- “PCI-6601 Pulse Width/Period Measurement” on page 22-122
- “PCI-6601 Armed Pulse Generation” on page 22-124

xPC Target does not support the interrupt or timer functionality of the board.

### Board Characteristics

|                                 |                      |
|---------------------------------|----------------------|
| Board name                      | PCI-6601             |
| Manufacturer                    | National Instruments |
| Bus type                        | PCI                  |
| Access method                   | I/O mapped           |
| Multiple block instance support | Yes                  |
| Multiple board support          | Yes                  |

### PCI-6601 Digital Input

Only one input block can exist in a model for any given board.

#### Driver Block Parameters

**Channel** — Enter numbers between 1 and 8 to select the digital input ports. This driver allows the selection of individual digital input ports in any order. The number of elements defines the number of digital lines used.

For example, to use the first four ports as digital input channels, enter

```
[1,2,3,4]
```

Number the lines beginning with 1 even though the board manufacturer starts numbering the ports with 0.

---

**Note** Treat the eight I/O ports as two groups of four ports. The two groups are ports 1 to 4 and ports 5 to 8. Do not specify both input and output channels in the same group of four ports. The driver will emit an error.

---

**Sample time** — Enter a base sample time or a multiple of the base sample time.

**PCI slot** — If only one board of this type is physically present in the target PC, enter

-1

to automatically locate the board.

If two or more boards of this type are physically present in the target PC, enter the bus number and the PCI slot number of the board associated with this driver block. Use the format [BusNumber, SlotNumber]. To determine the bus number and the PCI slot number, type

```
getxpcpci
```

## PCI-6601 Digital Output

Only one output block can exist in a model for any given board.

### Driver Block Parameters

**Channel** — Enter numbers between 1 and 8 to select the digital output ports. This driver allows the selection of individual digital output ports in any order. The number of elements defines the number of digital lines used.

For example, to use the last four ports as digital output channels, enter

```
[5,6,7,8]
```

Number the lines beginning with 1 even though the board manufacturer starts numbering the ports with 0.



---

**Note** Treat the eight I/O ports as two groups of four ports. The two groups are ports 1 to 4 and ports 5 to 8. Do not specify both input and output channels in the same group of four ports. The driver will emit an error.

---

**Reset vector** — The reset vector controls the behavior of the channel at model termination. Enter a scalar or a vector that is the same length as the channel vector. If you specify a scalar value, and the **Channel** parameter is longer, that setting is used for all channels. If you specify a value of 1, the corresponding channel is reset to the value specified in the initial value vector. If you specify a value of 0, the channel remains at the last value attained while the model was running.

For example, if the block parameters are set as follows:

- **Channel** — [5 6 7 8]
- **Reset vector** — [1 1 0 0]
- **Initial value vector** — [ 1 0 1 0]

Channels 5 and 6 will reset to the initial value vector. Channels 7 and 8 will hold at the last value attained while the model was running.

**Initial value vector** — The initial value vector contains the initial voltage values for the output channels. Enter a scalar or a vector that is the same length as the channel vector. If you specify a scalar value, that value is the initial value for all channels. The channels are set to the initial values between the time the model is downloaded and the time it is started.

When execution stops, the driver writes the vector values to the output channels if the corresponding entry in the **Reset vector** is set to 1.

For example, if the block parameters are set as follows:

- **Channel** — [5 6 7 8]
- **Reset vector** — [1 1 0 0]
- **Initial value vector** — [ 1 0 1 0]

When the target application is downloaded to the target, channel 5 is set to 1, channel 6 is set to 0, channel 7 is set to 1 and channel 8 is set to 0.

After the target application executes, then stops, channel 5 will be set back to 1 and channel 6 will be set to 0. Channels 7 and 8 will hold the last values attained.

**Sample time** — The usual sampletime in seconds. Can be a MATLAB variable.

**PCI slot** — The usual slot number as used by all PCI board drivers.

## **PCI-6601 Incremental Encoder**

### **Driver Block Parameters**

**Channel** — From the list, select a channel number between 1 and 4.

---

**Note** If you want to attach a 3-wire encoder, do so by connecting the channel A signal to the appropriate SOURCE pin, the channel B signal to the AUX pin, and the index signal to the GATE pin.

---

**Counting mode** — From the list, select a counting mode. Choose one of the following:

- Normal
- Quadrature Mode X1
- Quadrature Mode X2
- Quadrature Mode X4
- Two-pulse mode
- Synchronous Source Mode

**Initial count** — The initial count specifies the initial value for the counter. Enter a nonnegative integer.

**Reload at index pulse** — Select this check box to have the count value reset to the value of **Initial count** at each index pulse.

**Index phase** — If the **Reload at index pulse** check box is selected, the **Index phase** parameter specifies the phase of the quadrature signals during which the count will be reloaded with the initial count. The count is reloaded in response to a channel index pulse. From the list, select one of the following:

- A low B low
- A low B high
- A high B low
- A high B high

**Filter** — You can apply a digital debouncing filter to the input pins prior to processing. From the list, select one of the following filter types:

- None
- Synchronize input to Timebase 3 (20 MHz)
- Minimum pulse width 5 microsec
- Minimum pulse width 1 microsec
- Minimum pulse width 500 nanosec
- Minimum pulse width 100 nanosec
- Minimum pulse width 25 nanosec

**Sample time** — Enter the base sample time or a multiple of the base sample time.

**PCI slot** — If only one board of this type is physically present in your target PC, enter

- 1

If two or more boards of this type are physically present in the target PC, enter the bus number and the PCI slot number of the board associated with this driver block. Use the format [BusNumber, SlotNumber]. To determine the bus number and the PCI slot number, type

```
getxpcpci
```

## PCI-6601 Pulse Generation

The inputs to the block are separate, one for the high count and one for the low count.

### Driver Block Parameters

**Channel** — From the list, choose one of the following:

- 1

- 2
- 3
- 4

These parameters specify the counter(s) to be used with this driver block. In each case, one block is needed for each port.

The reference frequency for this board is 20 MHz.

**Initial high count** — Enter the number of clock ticks the counter should maintain for a high level.

**Initial low count** — Enter the number of clock ticks the counter should maintain at a low level.

**Sample time** — Base sample time or a multiple of the base sample time.

**PCI slot (-1:autosearch)** — If only one board of this type is physically present in the target PC, enter

-1

to automatically locate the board.

If two or more boards of this type are physically present in the target PC, enter the bus number and the PCI slot number of the board associated with this driver block. Use the format [BusNumber, SlotNumber]. To determine the bus number and the PCI slot number, type

```
getxpcpci
```

## **PCI-6601 Pulse Width/Period Measurement**

### **Driver Block Parameters**

**Channel** — From the list, choose one of the following:

- 1
- 2
- 3
- 4

These parameters specify the counter(s) to be used with this driver block. In each case, one block is needed for each port.

**Trigger mode** — From the list, choose Level Triggered or Edge Triggered. See the table below for an example of how **Trigger mode** and **Polarity** affect one another. In this table, the data in the Output column resulted from a 1KHz pulse train with a 25% low and a 75% high pulse.

**Polarity** — From the list, choose Active low or Active high. See the table below for an example of how **Trigger mode** and **Polarity** affect one another. In this table, the data in the Output column resulted from a 1KHz pulse train with a 25% low and a 75% high pulse.

| Measurement objective    | Trigger mode    | Polarity    | Output |
|--------------------------|-----------------|-------------|--------|
| Pulse width (low pulse)  | Level Triggered | Active low  | 5000   |
| Pulse width (high pulse) | Level Triggered | Active High | 15000  |
| Period                   | Edge Triggered  | NA          | 20000  |

In every case, the output of the block is the number of clock ticks (of the 20MHz source clock) required for the specified measurement. When measuring pulse width, the output reflects the number of clock ticks for which the input signal was in the specified (low or high) state. See the table above for an example.

**Sample time** — Base sample time or a multiple of the base sample time.

**PCI slot (-1:autosearch)** — If only one board of this type is physically present in the target PC, enter

-1

to automatically locate the board.

If two or more boards of this type are physically present in the target PC, enter the bus number and the PCI slot number of the board associated with this driver block. Use the format [BusNumber, SlotNumber]. To determine the bus number and the PCI slot number, type

getxpcpci

## PCI-6601 Armed Pulse Generation

The inputs to the block are separate, one for the high count (**H**), one for the low count (**L**), and one for the arm input (**A**). If the arm input signal is less than 0.5, the frequency generation is disabled. If the arm input signal is greater than or equal to 0.5, the frequency generation is enabled.

### Driver Block Parameters

**Channel** — From the list, choose one of the following:

- 1
- 2
- 3
- 4

These parameters specify the counter to be used with this driver block. In each case, one block is needed for each port.

The reference frequency for this board is 20 MHz.

**Initial high count** — Enter the number of clock ticks the counter should maintain for a high level.

**Initial low count** — Enter the number of clock ticks the counter should maintain at a low level.

**Sample time** — Base sample time or a multiple of the base sample time.

**PCI slot (-1:autosearch)** — If only one board of this type is physically present in the target PC, enter

-1

to automatically locate the board.

If two or more boards of this type are physically present in the target PC, enter the bus number and the PCI slot number of the board associated with this driver block. Use the format [BusNumber, SlotNumber]. To determine the bus number and the PCI slot number, type

getxpcpci

## PCI/PXI-6602

The National Instruments PCI/PXI-6602 is a general purpose counter/timer board. It has eight 32-bit counter channels. The reference frequency for this board is 80 MHz.

xPC Target supports this board with the following driver block:

- “PCI/PXI-6602 Digital Input” on page 22-125
- “PCI/PXI-6602 Digital Output” on page 22-126
- “PCI/PXI-6602 Incremental Encoder” on page 22-128
- “PCI/PXI-6602 Pulse Generation” on page 22-129
- “PCI/PXI-6602 Pulse Width/Period Measurement” on page 22-130
- “PCI/PXI-6602 Armed Pulse Generation” on page 22-132

xPC Target does not support the interrupt or timer functionality of the board.

### Board Characteristics

|                                 |                      |
|---------------------------------|----------------------|
| Board name                      | PCI/PXI-6602         |
| Manufacturer                    | National Instruments |
| Bus type                        | PCI                  |
| Access method                   | I/O mapped           |
| Multiple block instance support | Yes                  |
| Multiple board support          | Yes                  |

### PCI/PXI-6602 Digital Input

Only one input block can exist in a model for any given board.

#### Driver Block Parameters

**Channel** — Enter numbers between 1 and 8 to select the digital input ports. This driver allows the selection of individual digital input ports in any order. The number of elements defines the number of digital lines used.

For example, to use the first four ports as digital input channels, enter

```
[ 1,2,3,4]
```

Number the lines beginning with 1 even though the board manufacturer starts numbering the ports with 0.

---

**Note** Treat the eight I/O ports as two groups of four ports. The two groups are ports 1 to 4 and ports 5 to 8. Do not specify both input and output channels in the same group of four ports. The driver will emit an error.

---

**Sample time** — Enter a base sample time or a multiple of the base sample time.

**PCI slot** — If only one board of this type is physically present in the target PC, enter

-1

to automatically locate the board.

If two or more boards of this type are physically present in the target PC, enter the bus number and the PCI slot number of the board associated with this driver block. Use the format [BusNumber, SlotNumber]. To determine the bus number and the PCI slot number, type

```
getxpcpci
```

## **PCI/PXI-6602 Digital Output**

Only one output block can exist in a model for any given board.

### **Driver Block Parameters**

**Channel** — Enter numbers between 1 and 8 to select the digital output ports. This driver allows the selection of individual digital output ports in any order. The number of elements defines the number of digital lines used.

For example, to use the last four ports as digital output channels, enter

```
[5,6,7,8]
```

Number the lines beginning with 1 even though the board manufacturer starts numbering the ports with 0.



---

**Note** Treat the eight I/O ports as two groups of four ports. The two groups are ports 1 to 4 and ports 5 to 8. Do not specify both input and output channels in the same group of four ports. The driver will emit an error.

---

**Reset vector** — The reset vector controls the behavior of the channel at model termination. Enter a scalar or a vector that is the same length as the channel vector. If you specify a scalar value, and the **Channel** parameter is longer, that setting is used for all channels. If you specify a value of 1, the corresponding channel is reset to the value specified in the initial value vector. If you specify a value of 0, the channel remains at the last value attained while the model was running.

For example, if the block parameters are set as follows:

- **Channel** — [5 6 7 8]
- **Reset vector** — [1 1 0 0]
- **Initial value vector** — [ 1 0 1 0]

Channels 5 and 6 will reset to the initial value vector. Channels 7 and 8 will hold at the last value attained while the model was running.

**Initial value vector** — The initial value vector contains the initial voltage values for the output channels. Enter a scalar or a vector that is the same length as the channel vector. If you specify a scalar value, that value is the initial value for all channels. The channels are set to the initial values between the time the model is downloaded and the time it is started.

When execution stops, the driver writes the vector values to the output channels if the corresponding entry in the **Reset vector** is set to 1.

For example, if the block parameters are set as follows:

- **Channel** — [5 6 7 8]
- **Reset vector** — [1 1 0 0]
- **Initial value vector** — [ 1 0 1 0]

When the target application is downloaded to the target, channel 5 is set to 1, channel 6 is set to 0, channel 7 is set to 1 and channel 8 is set to 0.

After the target application executes, then stops, channel 5 will be set back to 1 and channel 6 will be set to 0. Channels 7 and 8 will hold the last values attained.

**Sample time** — The usual samptime in seconds. Can be a Matlab variable.

**PCI slot** — The usual slot number as used by all PCI board drivers.

## **PCI/PXI-6602 Incremental Encoder**

### **Driver Block Parameters**

**Channel** — From the list, select a channel number between 1 and 8.

---

**Note** If you want to attach a 3-wire encoder, do so by connecting the channel A signal to the appropriate SOURCE pin, the channel B signal to the AUX pin, and the index signal to the GATE pin.

---

**Counting mode** — From the list, select a counting mode. Choose one of the following:

- Normal
- Quadrature Mode X1
- Quadrature Mode X2
- Quadrature Mode X4
- Two-pulse mode
- Synchronous Source Mode

**Initial count** — The initial count specifies the initial value for the counter. Enter a nonnegative integer.

**Reload at index pulse** — Select this check box to have the count value reset to the value of **Initial count** at each index pulse.

**Index phase** — If the **Reload at index pulse** check box is selected, the **Index phase** parameter specifies the phase of the quadrature signals during which the count will be reloaded with the initial count. The count is reloaded in response to a channel index pulse. From the list, select one of the following:

- A low B low
- A low B high
- A high B low
- A high B high

**Filter** — You can apply a digital debouncing filter to the input pins prior to processing. From the list, select one of the following filter types:

- None
- Synchronize input to Timebase 3 (80 MHz)
- Minimum pulse width 5 microsec
- Minimum pulse width 1 microsec
- Minimum pulse width 500 nanosec
- Minimum pulse width 100 nanosec
- Minimum pulse width 25 nanosec

**Sample time** — Enter the base sample time or a multiple of the base sample time.

**PCI slot** — If only one board of this type is physically present in your target PC, enter

- 1

If two or more boards of this type are physically present in the target PC, enter the bus number and the PCI slot number of the board associated with this driver block. Use the format [BusNumber, SlotNumber]. To determine the bus number and the PCI slot number, type

```
getxpcpci
```

## PCI/PXI-6602 Pulse Generation

The inputs to the block are separate, one for the high count and one for the low count.

### Driver Block Parameters

**Channel** — From the list, choose one of the following:

- 1

- 2
- 3
- 4
- 5
- 6
- 7
- 8

These parameters specify the counter(s) to be used with this driver block. In each case, one block is needed for each port.

The reference frequency for this board is 80 MHz.

**Initial high count** — Enter the number of clock ticks the counter should maintain for a high level.

**Initial low count** — Enter the number of clock ticks the counter should maintain at a low level.

**Sample time** — Base sample time or a multiple of the base sample time.

**PCI slot (-1:autosearch)** — If only one board of this type is physically present in the target PC, enter

-1

to automatically locate the board.

If two or more boards of this type are physically present in the target PC, enter the bus number and the PCI slot number of the board associated with this driver block. Use the format [BusNumber, SlotNumber]. To determine the bus number and the PCI slot number, type

```
getxpcpci
```

## **PCI/PXI-6602 Pulse Width/Period Measurement**

### **Driver Block Parameters**

**Counter** — From the list, choose one of the following:

- 1
- 2

- 3
- 4
- 5
- 6
- 7
- 8

These parameters specify the counter(s) to be used with this driver block. In each case, one block is needed for each port.

**Trigger mode** — From the list, choose Level Triggered or Edge Triggered. See the table below for an example of how **Trigger mode** and **Polarity** affect one another. In this table, the data in the Output column resulted from a 1KHz pulse train with a 25% low and a 75% high pulse.

**Polarity** — From the list, choose Active low or Active high. See the table below for an example of how **Trigger mode** and **Polarity** affect one another. In this table, the data in the Output column resulted from a 1KHz pulse train with a 25% low and a 75% high pulse.

| Measurement objective    | Trigger mode    | Polarity    | Output |
|--------------------------|-----------------|-------------|--------|
| Pulse width (low pulse)  | Level Triggered | Active low  | 20000  |
| Pulse width (high pulse) | Level Triggered | Active High | 60000  |
| Period                   | Edge Triggered  | NA          | 80000  |

In every case, the output of the block is the number of clock ticks (of the 80MHz source clock) required for the specified measurement. When measuring pulse width, the output reflects the number of clock ticks for which the input signal was in the specified (low or high) state. See the table above for an example.

**Filter** — From the list, choose one of the following:

- None
- Synchronize input to Timebase 3 (80MHz)

- Minimum pulse width 5 microsec
- Minimum pulse width 1 microsec
- Minimum pulse width 500 nanosec
- Minimum pulse width 100 nanosec
- Minimum pulse width 25 nanosec

This parameter specifies the level of digital filtering you want to apply to the pin. See the National Instruments PCI/PXI-6602 user manual documentation for details.

**Sample time** — Base sample time or a multiple of the base sample time.

**PCI slot (-1:autosearch)** — If only one board of this type is physically present in the target PC, enter

-1

to automatically locate the board.

If two or more boards of this type are physically present in the target PC, enter the bus number and the PCI slot number of the board associated with this driver block. Use the format [BusNumber, SlotNumber]. To determine the bus number and the PCI slot number, type

```
getxpcpci
```

## PCI/PXI-6602 Armed Pulse Generation

The inputs to the block are separate, one for the high count (**H**), one for the low count (**L**), and one for the arm input (**A**). If the arm input signal is less than 0.5, the frequency generation is disabled. If the arm input signal is greater than or equal to 0.5, the frequency generation is enabled.

### Driver Block Parameters

**Channel** — From the list, choose one of the following:

- 1
- 2
- 3
- 4
- 5

- 6
- 7
- 8

These parameters specify the counter to be used with this driver block. In each case, one block is needed for each port.

The reference frequency for this board is 80 MHz.

**Initial high count** — Enter the number of clock ticks the counter should maintain for a high level.

**Initial low count** — Enter the number of clock ticks the counter should maintain at a low level.

**Sample time** — Base sample time or a multiple of the base sample time.

**PCI slot (-1:autosearch)** — If only one board of this type is physically present in the target PC, enter

- 1

to automatically locate the board.

If two or more boards of this type are physically present in the target PC, enter the bus number and the PCI slot number of the board associated with this driver block. Use the format [BusNumber, SlotNumber]. To determine the bus number and the PCI slot number, type

```
getxpcpci
```

## PCI-6703

The PCI-6703 is an I/O board with 16 voltage outputs and 8 digital I/O lines. xPC Target supports this board with this driver block:

- “PCI-6703 Analog Output (D/A)” on page 22-134

### Board Characteristics

|                                 |                      |
|---------------------------------|----------------------|
| Board name                      | PCI-6703             |
| Manufacturer                    | National Instruments |
| Bus type                        | PCI                  |
| Access method                   | Memory mapped        |
| Multiple block instance support | No                   |
| Multiple board support          | Yes                  |

## PCI-6703 Analog Output (D/A)

### Scaling Input to Output

| Hardware Output | Block Input Data Type | Scaling |
|-----------------|-----------------------|---------|
| volts           | Double                | 1       |

### Driver Block Parameters

**Channel vector** — Enter numbers between 1 and 16. This driver allows the selection of individual D/A channels in any order. The number of elements defines the number of D/A channels used. For example, to use the first and second analog output (D/A) channels, enter

[1,2]

Number the channels beginning with 1 even if the board manufacturer starts numbering the channels with 0.

**Sample time** — Base sample time or a multiple of the base sample time.



**PCI Slot (-1:autosearch)** — If only one board of this type is physically present in the target PC, enter

-1

to automatically locate the board.

If two or more boards of this type are physically present in the target PC, enter the bus number and the PCI slot number of the board associated with this driver block. Use the format [BusNumber, SlotNumber]. To determine the bus number and the PCI slot number, type

`getxpcpci`

## PCI-6704

The PCI-6704 is an I/O board with 16 voltage outputs, 16 current outputs, and 8 digital I/O lines.

xPC Target supports this board with this driver block:

- “PCI-6704 Analog Output (D/A)” on page 22-136

### Board Characteristics

|                                 |                      |
|---------------------------------|----------------------|
| Board name                      | PCI-6704             |
| Manufacturer                    | National Instruments |
| Bus type                        | PCI                  |
| Access method                   | Memory mapped        |
| Multiple block instance support | No                   |
| Multiple board support          | Yes                  |

## PCI-6704 Analog Output (D/A)

### Scaling Input to Output

| Hardware Output | Block Input Data Type | Scaling |
|-----------------|-----------------------|---------|
| volts           | Double                | 1       |

### Driver Block Parameters

**Channel vector** — Enter numbers between 1 and 32. Channels 1-16 refer to the voltage output channels, and 17-32 the current output channels. This driver allows the selection of individual D/A channels in any order. The number of elements defines the number of D/A channels used. For example, to use the first and second analog output (D/A) channels, enter

[1,2]

Number the channels beginning with 1 even if the board manufacturer starts numbering the channels with 0.

**Sample time** — Base sample time or a multiple of the base sample time.

**PCI Slot (-1:autosearch)** — If only one board of this type is physically present in the target PC, enter

-1

to automatically locate the board.

If two or more boards of this type are physically present in the target PC, enter the bus number and the PCI slot number of the board associated with this driver block. Use the format [BusNumber, SlotNumber]. To determine the bus number and the PCI slot number, type

```
getxpcpci
```

## PCI-6711

The PCI-6711 is an analog output board with 4 analog output (D/A) channels (12-bit) and 8 digital input and output lines.

xPC Target supports this board with these driver blocks:

- “PCI-6711 Analog Output (D/A)” on page 22-138
- “PCI-6711 Digital Input” on page 22-140
- “PCI-6711 Digital Output” on page 22-141

### Board Characteristics

|                                 |                           |
|---------------------------------|---------------------------|
| Board name                      | PCI-6711                  |
| Manufacturer                    | National Instruments      |
| Bus type                        | PCI                       |
| Access method                   | Memory mapped             |
| Multiple block instance support | D/A: No, Digital I/O: Yes |
| Multiple board support          | Yes                       |

### PCI-6711 Analog Output (D/A)

The analog output range of this board is set -10 to +10 volts.

### Scaling Input to Output

| Hardware Output | Block Input Data Type | Scaling |
|-----------------|-----------------------|---------|
| volts           | Double                | 1       |

### Driver Block Parameters

**Channel vector** — Enter numbers between 1 and 4. This driver allows the selection of individual D/A channels in any order. The number of elements defines the number of D/A channels used. For example, to use the analog output channels 1 and 2, enter

[1,2]

Number the channels beginning with 1 even though the board manufacturer starts numbering the channels with 0.

**Reset vector** — The reset vector controls the behavior of the channel at model termination. Enter a scalar or a vector that is the same length as the channel vector. If you specify a scalar value, that setting is used for all channels. If you specify a value of 1, the corresponding channel is reset to the value specified in the initial value vector. If you specify a value of 0, the channel remains at the last value attained while the model was running.

**Initial value vector** — The initial value vector contains the initial voltage values for the output channels. Enter a scalar or a vector that is the same length as the channel vector. If you specify a scalar value, that value is the initial value for all channels. The channels are set to the initial values between the time the model is downloaded and the time it is started.

**Sample time** — Base sample time or a multiple of the base sample time.

**PCI Slot (-1:autosearch)** — If only one board of this type is physically present in the target PC, enter

-1

to automatically locate the board.

If two or more boards of this type are physically present in the target PC, enter the bus number and the PCI slot number of the board associated with this driver block. Use the format [BusNumber, SlotNumber]. To determine the bus number and the PCI slot number, type

```
getxpcpci
```

## PCI-6711 Digital Input

### Scaling Input to Output

| Hardware Input | Block Output Data Type | Scaling                         |
|----------------|------------------------|---------------------------------|
| TTL            | Double                 | TTL low = 0.0<br>TTL high = 1.0 |

### Driver Block Parameters

**Channel vector** — Enter numbers between 1 and 8 to select the digital input lines used with this port. This driver allows the selection of individual digital input lines in any order. The number of elements defines the number of digital lines used.

For example, to use all of the digital inputs for one port, enter

```
[1,2,3,4,5,6,7,8]
```

Each line can be used for input or output. If a line is not listed in this field, a digital output block using the same board can use that line.

Number the lines beginning with 1 even though the board manufacturer starts numbering the lines with 0.

**Sample time** — Enter a base sample time or a multiple of the base sample time.

**PCI Slot (-1:autosearch)** — If only one board of this type is physically present in the target PC, enter

```
-1
```

to automatically locate the board.

If two or more boards of this type are physically present in the target PC, enter the bus number and the PCI slot number of the board associated with this driver block. Use the format [BusNumber, SlotNumber]. To determine the bus number and the PCI slot number, type

```
getxpcpci
```

## PCI-6711 Digital Output

### Scaling Input to Output

| Hardware Output | Block Input Data Type | Scaling                             |
|-----------------|-----------------------|-------------------------------------|
| TTL             | Double                | < 0.5 = TTL low<br>≥ 0.5 = TTL high |

### Driver Block Parameters

**Channel vector** — Enter numbers between 1 and 8 to select the digital output lines used with this port. This driver allows the selection of individual digital output lines in any order. The number of elements defines the number of digital lines used.

For example, to use all of the digital outputs for one port, enter

```
[1,2,3,4,5,6,7,8]
```

Each line can be used for input or output. If a line is not listed in this field, a digital input block using the same board can use that line.

Number the lines beginning with 1 even though the board manufacturer starts numbering the lines with 0.

**Reset vector** — The reset vector controls the behavior of the channel at model termination. Enter a scalar or a vector that is the same length as the channel vector. If you specify a scalar value, that setting is used for all channels. If you specify a value of 1, the corresponding channel is reset to the value specified in the initial value vector. If you specify a value of 0, the channel remains at the last value attained while the model was running.

**Initial value vector** — The initial value vector contains the initial values (0 or 1) of the output channels. Enter a scalar or a vector that is the same length as the channel vector. If you enter a scalar, that value is used for all channels. The channels are set to these initial values between the time the model is downloaded and the time it is started.

**Sample time** — Enter a base sample time or a multiple of the base sample time.

**PCI Slot (-1:autosearch)** — If only one board of this type is physically present in the target PC, enter

-1

to automatically locate the board.

If two or more boards of this type are physically present in the target PC, enter the bus number and the PCI slot number of the board associated with this driver block. Use the format [BusNumber, SlotNumber]. To determine the bus number and the PCI slot number, type

`getxpcpci`



## PCI/PXI-6713

The PCI/PXI-6713 is an analog output board with 8 analog output (D/A) channels (12-bit) and 8 digital input and output lines.

xPC Target supports this board with these driver blocks:

- “PCI/PXI-6713 Analog Output (D/A)” on page 22-143
- “PCI/PXI-6713 Digital Input” on page 22-145
- “PCI/PXI-6713 Digital Output” on page 22-146

### Board Characteristics

|                                 |                           |
|---------------------------------|---------------------------|
| Board name                      | PCI/PXI-6713              |
| Manufacturer                    | National Instruments      |
| Bus type                        | PCI/PXI                   |
| Access method                   | Memory mapped             |
| Multiple block instance support | D/A: No, Digital I/O: Yes |
| Multiple board support          | Yes                       |

### PCI/PXI-6713 Analog Output (D/A)

The analog output range of this board is set -10 to +10 volts.

#### Scaling Input to Output

| Hardware Output | Block Input Data Type | Scaling |
|-----------------|-----------------------|---------|
| volts           | Double                | 1       |

#### Driver Block Parameters

**Channel vector** — Enter numbers between 1 and 8. This driver allows the selection of individual D/A channels in any order. The number of elements defines the number of D/A channels used. For example, to use the analog output channels 1 and 2, enter

[1,2]

Number the channels beginning with 1 even though the board manufacturer starts numbering the channels with 0.

**Reset vector** — The reset vector controls the behavior of the channel at model termination. Enter a scalar or a vector that is the same length as the channel vector. If you specify a scalar value, that setting is used for all channels. If you specify a value of 1, the corresponding channel is reset to the value specified in the initial value vector. If you specify a value of 0, the channel remains at the last value attained while the model was running.

**Initial value vector** — The initial value vector contains the initial voltage values for the output channels. Enter a scalar or a vector that is the same length as the channel vector. If you specify a scalar value, that value is the initial value for all channels. The channels are set to the initial values between the time the model is downloaded and the time it is started.

**Sample time** — Base sample time or a multiple of the base sample time.

**PCI Slot (-1:autosearch)** — If only one board of this type is physically present in the target PC, enter

-1

to automatically locate the board.

If two or more boards of this type are physically present in the target PC, enter the bus number and the PCI slot number of the board associated with this driver block. Use the format [BusNumber, SlotNumber]. To determine the bus number and the PCI slot number, type

```
getxpcpci
```

## PCI/PXI-6713 Digital Input

### Scaling Input to Output

| Hardware Input | Block Output Data Type | Scaling                         |
|----------------|------------------------|---------------------------------|
| TTL            | Double                 | TTL low = 0.0<br>TTL high = 1.0 |

### Driver Block Parameters

**Channel vector** — Enter numbers between 1 and 8 to select the digital input lines used with this port. This driver allows the selection of individual digital input lines in any order. The number of elements defines the number of digital lines used.

For example, to use all of the digital inputs for one port, enter

```
[1,2,3,4,5,6,7,8]
```

Each line can be used for input or output. If a line is not listed in this field, a digital output block using the same board can use that line.

Number the lines beginning with 1 even though the board manufacturer starts numbering the lines with 0.

**Sample time** — Enter a base sample time or a multiple of the base sample time.

**PCI Slot (-1:autosearch)** — If only one board of this type is physically present in the target PC, enter

```
-1
```

to automatically locate the board.

If two or more boards of this type are physically present in the target PC, enter the bus number and the PCI slot number of the board associated with this driver block. Use the format [BusNumber, SlotNumber]. To determine the bus number and the PCI slot number, type

```
getxpcpci
```

## PCI/PXI-6713 Digital Output

### Scaling Input to Output

| Hardware Output | Block Input Data Type | Scaling                                                  |
|-----------------|-----------------------|----------------------------------------------------------|
| TTL             | Double                | $< 0.5 = \text{TTL low}$<br>$\geq 0.5 = \text{TTL high}$ |

### Driver Block Parameters

**Channel vector** — Enter numbers between 1 and 8 to select the digital output lines used with this port. This driver allows the selection of individual digital output lines in any order. The number of elements defines the number of digital lines used.

For example, to use all of the digital outputs for one port, enter

```
[ 1, 2, 3, 4, 5, 6, 7, 8 ]
```

Each line can be used for input or output. If a line is not listed in this field, a digital input block using the same board can use that line.

Number the lines beginning with 1 even though the board manufacturer starts numbering the lines with 0.

**Reset vector** — The reset vector controls the behavior of the channel at model termination. Enter a scalar or a vector that is the same length as the channel vector. If you specify a scalar value, that setting is used for all channels. If you specify a value of 1, the corresponding channel is reset to the value specified in the initial value vector. If you specify a value of 0, the channel remains at the last value attained while the model was running.

**Initial value vector** — The initial value vector contains the initial values (0 or 1) of the output channels. Enter a scalar or a vector that is the same length as the channel vector. If you enter a scalar, that value is used for all channels. The channels are set to these initial values between the time the model is downloaded and the time it is started.

**Sample time** — Enter a base sample time or a multiple of the base sample time.

**PCI Slot (-1:autosearch)** — If only one board of this type is physically present in the target PC, enter

-1

to automatically locate the board.

If two or more boards of this type are physically present in the target PC, enter the bus number and the PCI slot number of the board associated with this driver block. Use the format [BusNumber, SlotNumber]. To determine the bus number and the PCI slot number, type

`getxpcpci`

## PCI-DIO-96

The PC-DIO-96 is an I/O board with 96 digital input and output lines. xPC Target supports this board with these driver blocks:

- “PCI-DIO-96 Digital Input” on page 22-148
- “PCI-DIO-96 Digital Output” on page 22-149

### Board Characteristics

|                                 |                      |
|---------------------------------|----------------------|
| Board name                      | PC-DIO-96            |
| Manufacturer                    | National Instruments |
| Bus type                        | PCI                  |
| Access method                   | I/O mapped           |
| Multiple block instance support | Yes                  |
| Multiple board support          | Yes                  |

### PCI-DIO-96 Digital Input

The PC-DIO-96 has four 8255 chips with 3 ports (A,B,C). Each port has a maximum of 8 digital I/O lines that can be configured as inputs or outputs.

Use a separate driver block for each port. By selecting the digital input driver block, the port is configured as input.

### Scaling of Input to Output

| Hardware Input | Block Output Data Type | Scaling                         |
|----------------|------------------------|---------------------------------|
| TTL            | Double                 | TTL low = 0.0<br>TTL high = 1.0 |

## Driver Block Parameters

**Channel vector** — Enter numbers between 1 and 8 to select the digital input lines used with this port. This driver allows the selection of individual digital input lines in any order. The number of elements defines the number of digital lines used.

For example, to use all of the digital inputs for one port, enter

```
[ 1,2,3,4,5,6,7,8]
```

Number the lines beginning with 1 even if the board manufacturer starts numbering the lines with 0.

**Port** — From the list choose either A, B, or C. The I/O board has four 8255 chips with 3 ports. The **Port** parameter defines which port of the 8255 chip is used for this driver block. Each port has a maximum of 8 digital lines that can be configured as inputs or outputs depending on which driver block is chosen. In each case, one block is needed for each port.

**Chip** — From the list choose 1, 2, 3, or 4.

**Sample time** — Enter a base sample time or a multiple of the base sample time.

**Base address** — Enter the base address of the board. This entry must correspond to the DIP-switch settings on the board. For example, if the base address is 300 (hexadecimal), enter

```
0x300
```

## PCI-DIO-96 Digital Output

The PC-DIO24 has four 8255 chips with 3 ports (A,B,C). Each port has a maximum of 8 digital I/O lines that can be configured as inputs or outputs.

Use a separate driver block for each port. By selecting the digital output driver block, the port is configured as output.

## Scaling of Input to Output

| Hardware Output | Block Input Data Type | Scaling                             |
|-----------------|-----------------------|-------------------------------------|
| TTL             | Double                | < 0.5 = TTL low<br>≥ 0.5 = TTL high |

### Driver Block Parameters

**Channel vector** — Enter numbers between 1 and 8 to select the digital output lines used with this port. This driver allows the selection of individual digital output lines in any order. The number of elements defines the number of digital lines used.

For example, to use all of the digital outputs for one port, enter

```
[ 1, 2, 3, 4, 5, 6, 7, 8]
```

Number the lines beginning with 1 even if the board manufacturer starts numbering the lines with 0.

**Port** — From the list choose either A, B, or C. The I/O board has a 8255 chip with 3 ports. The **Port** parameter defines which port of the 8255 chip is used for this driver block. Each port has a maximum of 8 digital lines that can be configured as inputs or outputs depending on which driver block is chosen. In each case, one block is needed for each port.

**Reset vector** — The reset vector controls the behavior of the channel at model termination. Enter a scalar or a vector that is the same length as the channel vector. If you specify a scalar value, that setting is used for all channels. If you specify a value of 1, the corresponding channel is reset to the value specified in the initial value vector. If you specify a value of 0, the channel remains at the last value attained while the model was running.

**Initial value vector** — The initial value vector contains the initial values (0 or 1) of the output channels. Enter a scalar or a vector that is the same length as the channel vector. If you enter a scalar, that value is used for all channels. The channels are set to these initial values between the time the model is downloaded and the time it is started.

**Chip** — From the list choose 1, 2, 3, or 4.



**Sample time** — Enter a base sample time or a multiple of the base sample time.

**Base address** — Enter the base address of the board. This entry must corresponds to the DIP-switch settings on the board. For example, if the base address is 300 (hexadecimal), enter

0x300

## PXI-6040E

The PXI-6040E is an I/O board with 16 single or 8 differential analog input channels (12-bit) with a maximum sample rate of 500 kHz, 2 analog output channels (12-bit), 8 digital input and output lines, and 2 counter/timers (24-bit) with a maximum source clock rate of 20 MHz.

xPC Target supports this board with these driver blocks:

- “PXI-6040E Analog Input (A/D)” on page 22-153
- “PXI-6040E Analog Output (D/A)” on page 22-155
- “PXI-6040E Digital Input” on page 22-157
- “PXI-6040E Digital Output” on page 22-158
- “PXI-6040E Pulse Generation” on page 22-159
- “PXI-6040E Pulse Width/Period Measurement” on page 22-160

### Board Characteristics

|                                 |                                                                                                         |
|---------------------------------|---------------------------------------------------------------------------------------------------------|
| Board name                      | PXI-6040E                                                                                               |
| Manufacturer                    | National Instruments                                                                                    |
| Bus type                        | PXI (Compact PCI)                                                                                       |
| Access method                   | Memory mapped                                                                                           |
| Multiple block instance support | A/D: No, D/A: No, Digital I/O: Yes;<br>Period/Pulsewidth measurement: Yes;<br>Pulsetrain Generation: No |
| Multiple board support          | Yes                                                                                                     |

## PXI-6040E Analog Input (A/D)

### Scaling Input to Output

| Hardware Input | Block Output Data Type | Scaling |
|----------------|------------------------|---------|
| volts          | Double                 | 1       |

### Driver Block Parameters

**Channel vector** — Enter numbers between 1 and 16. This driver allows you to enter channel numbers in any order.

For example, to use the first, second and fifth channels, enter

[1,2,5]

Number the channels beginning with 1 even if the board manufacturer starts numbering the channels with 0.

**Range vector** — Enter a range code for each of the channels in the channel vector. The range vector must be the same length as the channel vector. This driver allows each channel to be different.

The following table is a list of the ranges for this driver and the corresponding range codes.

| Input Range (V) | Range Code | Input Range (V) | Range Code |
|-----------------|------------|-----------------|------------|
| -10 to +10      | -10        | 0 - 10          | 10         |
| -5 to +5        | -5         | 0 - 5           | 5          |
| -2 to +2        | -2         | 0 - 2           | 2          |
| -1 to + 1       | -1         | 0 - 1           | 1          |
| -0.5 to +0.5    | -0.5       | 0 - 0.5         | 0.5        |
| -0.2 to +0.2    | -0.2       | 0 - 0.2         | 0.2        |

| Input Range (V) | Range Code | Input Range (V) | Range Code |
|-----------------|------------|-----------------|------------|
| -0.1 to +0.1    | -0.1       | 0 - 0.1         | 0.1        |
| -0.05 to +0.05  | -0.05      |                 |            |

For example, if the first channel is -10 to + 10 volts and the second and fifth channels are 0 to +1 volts, enter

[ -10, 1, 1]

**Input coupling vector** — Enter a coupling code for each of the channels in the channel vector. The coupling vector must be the same length as the channel vector. This driver allows a different coupling for each channel.

The following table is a list of the couplings for this driver and the corresponding coupling codes.

| Coupling | Coupling Code | Description                                                                                                                                                              |
|----------|---------------|--------------------------------------------------------------------------------------------------------------------------------------------------------------------------|
| RSE      | 0             | Analog input line connected to the positive input of the PGIA. Analog input ground (AIGND) internally connected to the negative input of the PGIA. See the board manual. |
| NRSE     | 1             | Analog input line connected to the positive input of the PGIA. Analog input sense (AISENSE) connected to the negative input of the PGIA. See the board manual.           |
| DIFF     | 2             | First analog input line connected to the positive input of the PGIA. Second analog input line connected to the negative input of the PGIA. See the board manual.         |

For example, if the first and second channels are single input and the fifth channel is a differential input, enter

[0,0,2]

The driver selects a second differential input 8 channels higher than the first channel. In the example above, the driver would select the thirteenth channel as a differential input with the fifth channel.

**Sample time** — Model base sample time or a multiple of the base sample time.

**PCI Slot (-1:autosearch)** — If only one board of this type is physically present in the target PC, enter

-1

to automatically locate the board.

If two or more boards of this type are physically present in the target PC, enter the bus number and the PCI slot number of the board associated with this driver block. Use the format [BusNumber, SlotNumber]. To determine the bus number and the PCI slot number, type

```
getxpcpci
```

## PXI-6040E Analog Output (D/A)

### Scaling of Input to Output

| Hardware Output | Block Input Data Type | Scaling |
|-----------------|-----------------------|---------|
| volts           | Double                | 1       |

### Driver Block Parameters

**Channel vector** — Enter 1 or 2. This driver allows the selection of individual D/A channels in any order. The number of elements defines the number of D/A channels used. For example, to use both of the analog output channels, enter

[1,2]

Number the channels beginning with 1 even if the board manufacturer starts numbering the channels with 0.

**Range vector** — Enter a range code for each of the channels in the channel vector. The range vector must be the same length as the channel vector. This board allows the range of each channel to be different.

The following table is a list of the ranges for this driver and the corresponding range codes.

| Input Range (V) | Range Code | Input Range (V) | Range Code |
|-----------------|------------|-----------------|------------|
| -10 to +10      | -10        | 0 - 10          | 10         |

For example, if the first channel is -10 to +10 volts, and the second channel is 0 to 5 volts, enter

[ -10,5]

**Reset vector** — The reset vector controls the behavior of the channel at model termination. Enter a scalar or a vector that is the same length as the channel vector. If you specify a scalar value, that setting is used for all channels. If you specify a value of 1, the corresponding channel is reset to the value specified in the initial value vector. If you specify a value of 0, the channel remains at the last value attained while the model was running.

**Initial value vector** — The initial value vector contains the initial voltage values for the output channels. Enter a scalar or a vector that is the same length as the channel vector. If you specify a scalar value, that value is the initial value for all channels. The channels are set to the initial values between the time the model is downloaded and the time it is started.

**Sample time** — Base sample time or a multiple of the base sample time.

**PCI Slot (-1:autosearch)** — If only one board of this type is physically present in the target PC, enter

-1

to automatically locate the board.

If two or more boards of this type are physically present in the target PC, enter the bus number and the PCI slot number of the board associated with this driver block. Use the format [BusNumber, SlotNumber]. To determine the bus number and the PCI slot number, type

getxpcpci

## PXI-6040E Digital Input

### Scaling Input to Output

| Hardware Input | Block Output Data Type | Scaling                         |
|----------------|------------------------|---------------------------------|
| TTL            | Double                 | TTL low = 0.0<br>TTL high = 1.0 |

### Driver Block Parameters

**Channel vector** — Enter numbers between 1 and 8 to select the digital input lines used with this port. This driver allows the selection of individual digital input lines in any order. The number of elements defines the number of digital lines used.

For example, to use all of the digital inputs for one port, enter

```
[1,2,3,4,5,6,7,8]
```

Number the lines beginning with 1 even if the board manufacturer starts numbering the lines with 0.

**Sample time** — Enter a base sample time or a multiple of the base sample time.

**PCI Slot (-1:autosearch)** — If only one board of this type is physically present in the target PC, enter

```
-1
```

to automatically locate the board.

If two or more boards of this type are physically present in the target PC, enter the bus number and the PCI slot number of the board associated with this driver block. Use the format [BusNumber, SlotNumber]. To determine the bus number and the PCI slot number, type

```
getxpcpci
```

## PXI-6040E Digital Output

### Scaling Input to Output

| Hardware Output | Block Input Data Type | Scaling                         |
|-----------------|-----------------------|---------------------------------|
| TTL             | Double                | TTL low = 0.0<br>TTL high = 1.0 |

### Driver Block Parameters

**Channel vector** — Enter numbers between 1 and 8 to select the digital output lines used with this port. This driver allows the selection of individual digital output lines in any order. The number of elements defines the number of digital lines used.

For example, to use all of the digital outputs for one port, enter

```
[1,2,3,4,5,6,7,8]
```

Number the lines beginning with 1 even if the board manufacturer starts numbering the lines with 0.

**Reset vector** — The reset vector controls the behavior of the channel at model termination. Enter a scalar or a vector that is the same length as the channel vector. If you specify a scalar value, that setting is used for all channels. If you specify a value of 1, the corresponding channel is reset to the value specified in the initial value vector. If you specify a value of 0, the channel remains at the last value attained while the model was running.

**Initial value vector** — The initial value vector contains the initial values (0 or 1) of the output channels. Enter a scalar or a vector that is the same length as the channel vector. If you enter a scalar, that value is used for all channels. The channels are set to these initial values between the time the model is downloaded and the time it is started.

**Sample time** — Enter a base sample time or a multiple of the base sample time.



**PCI Slot (-1:autosearch)** — If only one board of this type is physically present in the target PC, enter

-1

to automatically locate the board.

If two or more boards of this type are physically present in the target PC, enter the bus number and the PCI slot number of the board associated with this driver block. Use the format [BusNumber, SlotNumber]. To determine the bus number and the PCI slot number, type

```
getxpcpci
```

## PXI-6040E Pulse Generation

The inputs to the block should be a two element vector. The first element is the number of counts (of the 20 MHz source clock) that the counter should maintain at a low level, and the second element is the number of clock ticks for a high level. For example, to generate a pulsetrain at 1KHz with 25% low and 75% high, use the vector

```
[5000 15000]
```

### Driver Block Parameters

**Counter** — From the list, choose Counter 0, Counter 1, or Both to select the counter(s) to be used with this driver block. In each case, one block is needed for each physical board.

**Sample time** — Base sample time or a multiple of the base sample time.

**PCI slot (-1:autosearch)** — If only one board of this type is physically present in the target PC, enter

-1

to automatically locate the board.

If two or more boards of this type are physically present in the target PC, enter the bus number and the PCI slot number of the board associated with this driver block. Use the format [BusNumber, SlotNumber]. To determine the bus number and the PCI slot number, type

```
getxpcpci
```

## PXI-6040E Pulse Width/Period Measurement

### Driver Block Parameters

**Counter** — From the list, select a counter from 0 or 1.

**Trigger mode** — From the list, choose Level Triggered or Edge Triggered. See the table below for an example of how **Trigger mode** and **Polarity** affect one another. In this table, the data in the Output column resulted from a 1KHz pulse train with a 25% low and a 75% high pulse.

**Polarity** — From the list, choose Active low or Active high. See the table below for an example of how **Trigger mode** and **Polarity** affect one another. In this table, the data in the Output column resulted from a 1KHz pulse train with a 25% low and a 75% high pulse.

| Measurement objective    | Trigger mode    | Polarity    | Output |
|--------------------------|-----------------|-------------|--------|
| Pulse width (low pulse)  | Level Triggered | Active low  | 5000   |
| Pulse width (high pulse) | Level Triggered | Active High | 15000  |
| Period                   | Edge Triggered  | NA          | 20000  |

In every case, the output of the block is the number of clock ticks (of the 20MHz source clock) required for the specified measurement. When measuring pulse width, the output reflects the number of clock ticks for which the input signal was in the specified (low or high) state. See the table above for an example.

**Sample time** — Base sample time or a multiple of the base sample time.

**PCI slot (-1:autosearch)** — If only one board of this type is physically present in the target PC, enter

- 1

to automatically locate the board.

If two or more boards of this type are physically present in the target PC, enter the bus number and the PCI slot number of the board associated with this driver block. Use the format [BusNumber, SlotNumber]. To determine the bus number and the PCI slot number, type

```
getxpcpci
```

## PXI-6070E

The PXI-6070E is an I/O board with 16 single or 8 differential analog input channels (12-bit) with a maximum sample rate of 1.25 MHz, 2 analog output channels (12-bit), 8 digital input and output lines, and 2 counter/timers (24-bit) with a maximum source clock rate of 20 MHz.

xPC Target supports this board with these driver blocks:

- “PXI-6070E Analog Input (A/D)” on page 22-162
- “PXI-6070E Analog Output (D/A)” on page 22-165
- “PXI-6070E Digital Input” on page 22-166
- “PXI-6070E Digital Output” on page 22-167
- “PXI-6070E Pulse Generation” on page 22-169
- “PXI-6070E Pulse Width/Period Measurement” on page 22-169

### Board Characteristics

|                                 |                                                                                                         |
|---------------------------------|---------------------------------------------------------------------------------------------------------|
| Board name                      | PXI-6070E                                                                                               |
| Manufacturer                    | National Instruments                                                                                    |
| Bus type                        | PXI (Compact PCI)                                                                                       |
| Multiple block instance support | A/D: No, D/A: No, Digital I/O: Yes;<br>Period/Pulsewidth measurement: Yes;<br>Pulsetrain Generation: No |
| Multiple board support          | Yes                                                                                                     |

### PXI-6070E Analog Input (A/D)

#### Scaling Input to Output

| Hardware Input | Block Output Data Type | Scaling |
|----------------|------------------------|---------|
| volts          | Double                 | 1       |

## Driver Block Parameters

**Channel vector** — Enter numbers between 1 and 16. This driver allows you to enter channel numbers in any order.

For example, to use the first, second and fifth channels, enter

[ 1,2,5]

Number the channels beginning with 1 even if the board manufacturer starts numbering the channels with 0.

**Range vector** — Enter a range code for each of the channels in the channel vector. The range vector must be the same length as the channel vector. This driver allows each channel to be different.

The following table is a list of the ranges for this driver and the corresponding range codes.

| Input range (V) | Range code | Input range (V) | Range code |
|-----------------|------------|-----------------|------------|
| -10 to +10      | -10        | 0 - 10          | 10         |
| -5 to +5        | -5         | 0 - 5           | 5          |
| -2 to +2        | -2         | 0 - 2           | 2          |
| -1 to + 1       | -1         | 0 - 1           | 1          |
| -0.5 to +0.5    | -0.5       | 0 - 0.5         | 0.5        |
| -0.2 to +0.2    | -0.2       | 0 - 0.2         | 0.2        |
| -0.1 to +0.1    | -0.1       | 0 - 0.1         | 0.1        |
| -0.05 to +0.05  | -0.05      |                 |            |

For example, if the first channel is -10 to + 10 volts and the second and fifth channels are 0 to +1 volts, enter

[ -10,1,1]

**Input coupling vector** — Enter a coupling code for each of the channels in the channel vector. The coupling vector must be the same length as the channel vector. This driver allows a different coupling for each channel.

The following table is a list of the couplings for this driver and the corresponding coupling codes.

| <b>Coupling</b> | <b>Coupling Code</b> | <b>Description</b>                                                                                                                                                       |
|-----------------|----------------------|--------------------------------------------------------------------------------------------------------------------------------------------------------------------------|
| RSE             | 0                    | Analog input line connected to the positive input of the PGIA. Analog input ground (AIGND) internally connected to the negative input of the PGIA. See the board manual. |
| NRSE            | 1                    | Analog input line connected to the positive input of the PGIA. Analog input sense (AISENSE) connected to the negative input of the PGIA. See the board manual.           |
| DIFF            | 2                    | First analog input line connected to the positive input of the PGIA. Second analog input line connected to the negative input of the PGIA. See the board manual.         |

For example, if the first and second channels are single input and the fifth channel is a differential input, enter

[0,0,2]

The driver selects a second differential input 8 channels higher than the first channel. In the example above, the driver would select the thirteenth channel as a differential input with the fifth channel.

**Sample time** — Model base sample time or a multiple of the base sample time.

**PCI Slot (-1:autosearch)** — If only one board of this type is physically present in the target PC, enter

-1

to automatically locate the board.

If two or more boards of this type are physically present in the target PC, enter the bus number and the PCI slot number of the board associated with this driver block. Use the format [BusNumber, SlotNumber]. To determine the bus number and the PCI slot number, type

```
getxpcpci
```

## PXI-6070E Analog Output (D/A)

### Scaling Input to Output

| Hardware Output | Block Input Data Type | Scaling |
|-----------------|-----------------------|---------|
| volts           | Double                | 1       |

### Driver Block Parameters

**Channel vector** — Enter 1 or 2. This driver allows the selection of individual D/A channels in any order. The number of elements defines the number of D/A channels used. For example, to use both of the analog output channels, enter

```
[1,2]
```

Number the channels beginning with 1 even if the board manufacturer starts numbering the channels with 0.

**Range vector** — Enter a range code for each of the channels in the channel vector. The range vector must be the same length as the channel vector. This board allows the range of each channel to be different.

The following table is a list of the ranges for this driver and the corresponding range codes.

| Input Range (V) | Range Code | Input Range (V) | Range Code |
|-----------------|------------|-----------------|------------|
| -10 to +10      | -10        | 0 - 10          | 10         |

For example, if the first channel is -10 to +10 volts, and the second channel is 0 to 5 volts, enter

```
[-10,5]
```

**Reset vector** — The reset vector controls the behavior of the channel at model termination. Enter a scalar or a vector that is the same length as the channel vector. If you specify a scalar value, that setting is used for all channels. If you specify a value of 1, the corresponding channel is reset to the value specified in the initial value vector. If you specify a value of 0, the channel remains at the last value attained while the model was running.

**Initial value vector** — The initial value vector contains the initial voltage values for the output channels. Enter a scalar or a vector that is the same length as the channel vector. If you specify a scalar value, that value is the initial value for all channels. The channels are set to the initial values between the time the model is downloaded and the time it is started.

**Sample time** — Base sample time or a multiple of the base sample time.

**PCI Slot (-1:autosearch)** — If only one board of this type is physically present in the target PC, enter

-1

to automatically locate the board.

If two or more boards of this type are physically present in the target PC, enter the bus number and the PCI slot number of the board associated with this driver block. Use the format [BusNumber, SlotNumber]. To determine the bus number and the PCI slot number, type

getxpcpci

## PXI-6070E Digital Input

### Scaling Input to Output

| Hardware Input | Block Output Data Type | Scaling                         |
|----------------|------------------------|---------------------------------|
| TTL            | Double                 | TTL low = 0.0<br>TTL high = 1.0 |



## Driver Block Parameters

**Channel vector** — Enter numbers between 1 and 8 to select the digital input lines used with this port. This driver allows the selection of individual digital input lines in any order. The number of elements defines the number of digital lines used.

For example, to use all of the digital inputs for one port, enter

```
[1,2,3,4,5,6,7,8]
```

Number the lines beginning with 1 even if the board manufacturer starts numbering the lines with 0.

**Sample time** — Enter a base sample time or a multiple of the base sample time.

**PCI Slot (-1:autosearch)** — If only one board of this type is physically present in the target PC, enter

```
-1
```

to automatically locate the board.

If two or more boards of this type are physically present in the target PC, enter the bus number and the PCI slot number of the board associated with this driver block. Use the format [BusNumber, SlotNumber]. To determine the bus number and the PCI slot number, type

```
getxpcpci
```

## PXI-6070E Digital Output

### Scaling Input to Output

| Hardware Output | Block Input Data Type | Scaling                             |
|-----------------|-----------------------|-------------------------------------|
| TTL             | Double                | < 0.5 = TTL low<br>≥ 0.5 = TTL high |

### Driver Block Parameters

**Channel vector** — Enter numbers between 1 and 8 to select the digital output lines used with this port. This driver allows the selection of individual digital output lines in any order. The number of elements defines the number of digital lines used.

For example, to use all of the digital outputs for one port, enter

```
[ 1, 2, 3, 4, 5, 6, 7, 8 ]
```

Number the lines beginning with 1 even if the board manufacturer starts numbering the lines with 0.

**Reset vector** — The reset vector controls the behavior of the channel at model termination. Enter a scalar or a vector that is the same length as the channel vector. If you specify a scalar value, that setting is used for all channels. If you specify a value of 1, the corresponding channel is reset to the value specified in the initial value vector. If you specify a value of 0, the channel remains at the last value attained while the model was running.

**Initial value vector** — The initial value vector contains the initial values (0 or 1) of the output channels. Enter a scalar or a vector that is the same length as the channel vector. If you enter a scalar, that value is used for all channels. The channels are set to these initial values between the time the model is downloaded and the time it is started.

**Sample time** — Enter a base sample time or a multiple of the base sample time.

**PCI Slot (-1:autosearch)** — If only one board of this type is physically present in the target PC, enter

```
- 1
```

to automatically locate the board.

If two or more boards of this type are physically present in the target PC, enter the bus number and the PCI slot number of the board associated with this driver block. Use the format [BusNumber, SlotNumber]. To determine the bus number and the PCI slot number, type

```
getxpcpci
```

## PXI-6070E Pulse Generation

The inputs to the block should be a two element vector. The first element is the number of counts (of the 20 MHz source clock) that the counter should maintain at a low level, and the second element is the number of clock ticks for a high level. For example, to generate a pulsetrain at 1KHz with 25% low and 75% high, use the vector

```
[5000 15000]
```

### Driver Block Parameters

**Counter** — From the list, choose Counter 0, Counter 1, or Both to select the counter(s) to be used with this driver block. In each case, one block is needed for each physical board.

**Sample time** — Base sample time or a multiple of the base sample time.

**PCI slot (-1:autosearch)** — If only one board of this type is physically present in the target PC, enter

```
-1
```

to automatically locate the board.

If two or more boards of this type are physically present in the target PC, enter the bus number and the PCI slot number of the board associated with this driver block. Use the format [BusNumber, SlotNumber]. To determine the bus number and the PCI slot number, type

```
getxpcpci
```

## PXI-6070E Pulse Width/Period Measurement

### Driver Block Parameters

**Counter** — From the list, select a counter from 0 or 1.

**Trigger mode** — From the list, choose Level Triggered or Edge Triggered. See the table below for an example of how **Trigger mode** and **Polarity** affect one another. In this table, the data in the Output column resulted from a 1KHz pulse train with a 25% low and a 75% high pulse.

**Polarity** — From the list, choose `Active low` or `Active high`. See the table below for an example of how **Trigger mode** and **Polarity** affect one another. In this table, the data in the `Output` column resulted from a 1KHz pulse train with a 25% low and a 75% high pulse.

| <b>Measurement objective</b> | <b>Trigger mode</b> | <b>Polarity</b> | <b>Output</b> |
|------------------------------|---------------------|-----------------|---------------|
| Pulse width (low pulse)      | Level Triggered     | Active low      | 5000          |
| Pulse width (high pulse)     | Level Triggered     | Active High     | 15000         |
| Period                       | Edge Triggered      | NA              | 20000         |

In every case, the output of the block is the number of clock ticks (of the 20MHz source clock) required for the specified measurement. When measuring pulse width, the output reflects the number of clock ticks for which the input signal was in the specified (low or high) state. See the table above for an example.

**Sample time** — Base sample time or a multiple of the base sample time.

**PCI slot (-1:autosearch)** — If only one board of this type is physically present in the target PC, enter

-1

to automatically locate the board.

If two or more boards of this type are physically present in the target PC, enter the bus number and the PCI slot number of the board associated with this driver block. Use the format [BusNumber, SlotNumber]. To determine the bus number and the PCI slot number, type

```
getxpcpci
```

## PXI-6071E

The PXI-6071E is an I/O board with 64 single or 32 differential analog input (A/D) channels (12-bit) with a maximum sample rate of 1.25 MHz, 2 analog output (D/A) channels (12-bit), 8 digital input and output lines, and 2 counter/timers (24-bit) with a maximum source clock rate of 20 MHz.

xPC Target supports this board with these driver blocks:

- “PXI-6071E Analog Input (A/D)” on page 22-172
- “PXI-6071E Analog Output (D/A)” on page 22-174
- “PXI-6071E Digital Input” on page 22-176
- “PXI-6071E Digital Output” on page 22-177
- “PXI-6071E Pulse Generation” on page 22-178
- “PXI-6071E Pulse Width/Period Measurement” on page 22-179

### Board Characteristics

|                                 |                                                                                                         |
|---------------------------------|---------------------------------------------------------------------------------------------------------|
| Board Name                      | PXI-6071E                                                                                               |
| Manufacturer                    | National Instruments                                                                                    |
| Bus type                        | PCI                                                                                                     |
| Access method                   | Memory mapped                                                                                           |
| Multiple block instance support | A/D: No, D/A: No, Digital I/O: Yes;<br>Period/Pulsewidth measurement: Yes;<br>Pulsetrain Generation: No |
| Multiple board support          | Yes                                                                                                     |

## PXI-6071E Analog Input (A/D)

### Scaling Input to Output

| Hardware Input | Block Output Data Type | Scaling |
|----------------|------------------------|---------|
| volts          | Double                 | 1       |

### Driver Block Parameters

**Channel vector** — Enter numbers between 1 and 64. This driver allows you to enter channel numbers in any order.

For example, to use the first, second and fifth channels, enter

[1,2,5]

Number the channels beginning with 1 even if the board manufacturer starts numbering the channels with 0.

**Range vector** — Enter a range code for each of the channels in the channel vector. The range vector must be the same length as the channel vector. This driver allows each channel to be different.

The following table is a list of the ranges for this driver and the corresponding range codes.

| Input Range (V) | Range Code | Input Range (V) | Range Code |
|-----------------|------------|-----------------|------------|
| -10 to +10      | -10        | 0 to +10        | 10         |
| -5 to +5        | -5         | 0 to +5         | 5          |
| -2 to +2        | -2         | 0 to +2         | 2          |
| -1 to +1        | -1         | 0 to +1         | 1          |
| -0.5 to +0.5    | -0.5       | 0 to +0.5       | 0.5        |
| -0.2 to +0.2    | -0.2       | 0 to +0.2       | 0.2        |

| Input Range (V) | Range Code | Input Range (V) | Range Code |
|-----------------|------------|-----------------|------------|
| -0.1 to +0.1    | -0.1       | 0 to +0.1       | 0.1        |
| -0.05 to +0.05  | -0.05      |                 |            |

For example, if the first channel is -10 to + 10 volts and the second and fifth channels are 0 to +1 volts, enter

[ -10, 1, 1]

**Input coupling vector** — Enter a coupling code for each of the channels in the channel vector. The coupling vector must be the same length as the channel vector. This driver allows a different coupling for each channel.

The following table is a list of the couplings for this driver and the corresponding coupling codes.

| Coupling | Coupling Code | Description                                                                                                                                                              |
|----------|---------------|--------------------------------------------------------------------------------------------------------------------------------------------------------------------------|
| RSE      | 0             | Analog input line connected to the positive input of the PGIA. Analog input ground (AIGND) internally connected to the negative input of the PGIA. See the board manual. |
| NRSE     | 1             | Analog input line connected to the positive input of the PGIA. Analog input sense (AISENSE) connected to the negative input of the PGIA. See the board manual.           |
| DIFF     | 2             | First analog input line connected to the positive input of the PGIA. Second analog input line connected to the negative input of the PGIA. See the board manual.         |

For example, if the first and second channels are single input and the fifth channel is a differential input, enter

[0, 0, 2]

The driver selects a second differential input 8 channels higher than the first channel. In the example above, the driver would select the thirteenth channel as a differential input with the fifth channel.

**Sample time** — Model base sample time or a multiple of the base sample time.

**PCI Slot (-1:autosearch)** — If only one board of this type is physically present in the target PC, enter

-1

to automatically locate the board.

If two or more boards of this type are physically present in the target PC, enter the bus number and the PCI slot number of the board associated with this driver block. Use the format [BusNumber, SlotNumber]. To determine the bus number and the PCI slot number, type

```
getxpcpci
```

## PXI-6071E Analog Output (D/A)

### Scaling Input to Output

| Hardware Output | Block Input Data Type | Scaling |
|-----------------|-----------------------|---------|
| volts           | Double                | 1       |

### Driver Block Parameters

**Channel vector** — Enter 1 or 2. This driver allows the selection of individual D/A channels in any order. The number of elements defines the number of D/A channels used. For example, to use both of the analog output channels, enter

[1,2]

Number the channels beginning with 1 even if the board manufacturer starts numbering the channels with 0.

**Range vector** — Enter a range code for each of the channels in the channel vector. The range vector must be the same length as the channel vector. This board allows the range of each channel to be different.



The following table is a list of the ranges for this driver and the corresponding range codes.

| <b>Input Range (V)</b> | <b>Range Code</b> | <b>Input Range (V)</b> | <b>Range Code</b> |
|------------------------|-------------------|------------------------|-------------------|
| -10 to +10             | -10               | 0 - 10                 | 10                |

For example, if the first channel is -10 to +10 volts, and the second channel is 0 to 5 volts, enter

[ -10,5]

**Reset vector** — The reset vector controls the behavior of the channel at model termination. Enter a scalar or a vector that is the same length as the channel vector. If you specify a scalar value, that setting is used for all channels. If you specify a value of 1, the corresponding channel is reset to the value specified in the initial value vector. If you specify a value of 0, the channel remains at the last value attained while the model was running.

**Initial value vector** — The initial value vector contains the initial voltage values for the output channels. Enter a scalar or a vector that is the same length as the channel vector. If you specify a scalar value, that value is the initial value for all channels. The channels are set to the initial values between the time the model is downloaded and the time it is started.

**Sample time** — Base sample time or a multiple of the base sample time.

**PCI Slot (-1:autosearch)** — If only one board of this type is physically present in the target PC, enter

-1

to automatically locate the board.

If two or more boards of this type are physically present in the target PC, enter the bus number and the PCI slot number of the board associated with this driver block. Use the format [BusNumber, SlotNumber]. To determine the bus number and the PCI slot number, type

getxpcpci

## PXI-6071E Digital Input

### Scaling Input to Output

| Hardware Input | Block Output Data Type | Scaling                         |
|----------------|------------------------|---------------------------------|
| TTL            | Double                 | TTL low = 0.0<br>TTL high = 1.0 |

### Driver Block Parameters

**Channel vector** — Enter numbers between 1 and 8 to select the digital input lines used with this port. This driver allows the selection of individual digital input lines in any order. The number of elements defines the number of digital lines used.

For example, to use all of the digital inputs for one port, enter

```
[1,2,3,4,5,6,7,8]
```

Number the lines beginning with 1 even if the board manufacturer starts numbering the lines with 0.

**Sample time** — Enter a base sample time or a multiple of the base sample time.

**PCI Slot (-1:autosearch)** — If only one board of this type is physically present in the target PC, enter

```
-1
```

to automatically locate the board.

If two or more boards of this type are physically present in the target PC, enter the bus number and the PCI slot number of the board associated with this driver block. Use the format [BusNumber, SlotNumber]. To determine the bus number and the PCI slot number, type

```
getxpcpci
```

## PXI-6071E Digital Output

### Scaling Input to Output

| Hardware Output | Block Input Data Type | Scaling                             |
|-----------------|-----------------------|-------------------------------------|
| TTL             | Double                | < 0.5 = TTL low<br>≥ 0.5 = TTL high |

### Driver Block Parameters

**Channel vector** — Enter numbers between 1 and 8 to select the digital output lines used with this port. This driver allows the selection of individual digital output lines in any order. The number of elements defines the number of digital lines used.

For example, to use all of the digital outputs for one port, enter

```
[1,2,3,4,5,6,7,8]
```

Number the lines beginning with 1 even if the board manufacturer starts numbering the lines with 0.

**Reset vector** — The reset vector controls the behavior of the channel at model termination. Enter a scalar or a vector that is the same length as the channel vector. If you specify a scalar value, that setting is used for all channels. If you specify a value of 1, the corresponding channel is reset to the value specified in the initial value vector. If you specify a value of 0, the channel remains at the last value attained while the model was running.

**Initial value vector** — The initial value vector contains the initial values (0 or 1) of the output channels. Enter a scalar or a vector that is the same length as the channel vector. If you enter a scalar, that value is used for all channels. The channels are set to these initial values between the time the model is downloaded and the time it is started.

**Sample time** — Enter a base sample time or a multiple of the base sample time.

**PCI Slot (-1:autosearch)** — If only one board of this type is physically present in the target PC, enter

-1

to automatically locate the board.

If two or more boards of this type are physically present in the target PC, enter the bus number and the PCI slot number of the board associated with this driver block. Use the format [BusNumber, SlotNumber]. To determine the bus number and the PCI slot number, type

```
getxpcpci
```

## PXI-6071E Pulse Generation

The inputs to the block should be a two element vector. The first element is the number of counts (of the 20 MHz source clock) that the counter should maintain at a low level, and the second element is the number of clock ticks for a high level. For example, to generate a pulsetrain at 1KHz with 25% low and 75% high, use the vector

```
[5000 15000]
```

### Driver Block Parameters

**Counter** — From the list, choose Counter 0, Counter 1, or Both to select the counter(s) to be used with this driver block. In each case, one block is needed for each physical board.

**Sample time** — Base sample time or a multiple of the base sample time.

**PCI slot (-1:autosearch)** — If only one board of this type is physically present in the target PC, enter

-1

to automatically locate the board.

If two or more boards of this type are physically present in the target PC, enter the bus number and the PCI slot number of the board associated with this driver block. Use the format [BusNumber, SlotNumber]. To determine the bus number and the PCI slot number, type

```
getxpcpci
```

## PXI-6071E Pulse Width/Period Measurement

### Driver Block Parameters

**Counter** — From the list, select a counter from 0 or 1.

**Trigger mode** — From the list, choose Level Triggered or Edge Triggered. See the table below for an example of how **Trigger mode** and **Polarity** affect one another. In this table, the data in the Output column resulted from a 1KHz pulse train with a 25% low and a 75% high pulse.

**Polarity** — From the list, choose Active low or Active high. See the table below for an example of how **Trigger mode** and **Polarity** affect one another. In this table, the data in the Output column is the result of a 1KHz pulse train with a 25% low and a 75% high pulse.

| Measurement objective    | Trigger mode    | Polarity    | Output |
|--------------------------|-----------------|-------------|--------|
| Pulse width (low pulse)  | Level Triggered | Active low  | 5000   |
| Pulse width (high pulse) | Level Triggered | Active High | 15000  |
| Period                   | Edge Triggered  | NA          | 20000  |

In every case, the output of the block is the number of clock ticks (of the 20MHz source clock) required for the specified measurement. When measuring pulse width, the output reflects the number of clock ticks for which the input signal was in the specified (low or high) state. See the table above for an example.

**Sample time** — Base sample time or a multiple of the base sample time.

**PCI slot (-1:autosearch)** — If only one board of this type is physically present in the target PC, enter

-1

to automatically locate the board.

If two or more boards of this type are physically present in the target PC, enter the bus number and the PCI slot number of the board associated with this driver block. Use the format [BusNumber, SlotNumber]. To determine the bus number and the PCI slot number, type

```
getxpcpci
```

## PXI-6508

The PXI-6508 is an I/O board with 96 digital input and output lines. xPC Target supports this board with these driver blocks:

- “PXI-6508 Digital Input” on page 22-181
- “PXI-6508 Digital Output” on page 22-182

### Board Characteristics

|                                 |                      |
|---------------------------------|----------------------|
| Board name                      | PXI-6508             |
| Manufacturer                    | National Instruments |
| Bus type                        | PXI (Compact PCI)    |
| Access method                   | I/O mapped           |
| Multiple block instance support | Yes                  |
| Multiple board support          | Yes                  |

### PXI-6508 Digital Input

The PXI-6508 has four 8255 chip with 3 ports (A,B,C). Each port has a maximum of 8 digital I/O lines that can be configured as inputs or outputs.

Use a separate driver block for each port. By selecting the digital input driver block, the port is configured as input.

### Scaling of Input to Output

| Hardware Input | Block Output Data Type | Scaling                         |
|----------------|------------------------|---------------------------------|
| TTL            | Double                 | TTL low = 0.0<br>TTL high = 1.0 |

### Driver Block Parameters

**Channel vector** — Enter numbers between 1 and 8 to select the digital input lines used with this port. This driver allows the selection of individual digital input lines in any order. The number of elements defines the number of digital lines used.

For example, to use all of the digital inputs for one port, enter

```
[1,2,3,4,5,6,7,8]
```

Number the lines beginning with 1 even if the board manufacturer starts numbering the lines with 0.

**Port** — From the list choose either **A**, **B**, or **C**. The I/O board has a 8255 chip with 3 ports. The **Port** parameter defines which port of the 8255 chip is used for this driver block. Each port has a maximum of 8 digital lines that can be configured as inputs or outputs depending on which driver block is chosen. In each case, one block is needed for each port.

**Chip** — From the list choose 1, 2, 3, or 4.

**Sample time** — Enter a base sample time or a multiple of the base sample time.

**PCI Slot (-1:autosearch)** — If only one board of this type is physically present in the target PC, enter

```
-1
```

to automatically locate the board.

If two or more boards of this type are physically present in the target PC, enter the bus number and the PCI slot number of the board associated with this driver block. Use the format [BusNumber, SlotNumber]. To determine the bus number and the PCI slot number, type

```
getxpcpci
```

### PXI-6508 Digital Output

The PXI-6508 has four 8255 chip with 3 ports (A,B,C). Each port has a maximum of 8 digital I/O lines that can be configured as inputs or outputs.

Use a separate driver block for each port. By selecting the digital output driver block, the port is configured as output.



## Scaling of Input to Output

| Hardware Output | Block Input Data Type | Scaling                             |
|-----------------|-----------------------|-------------------------------------|
| TTL             | Double                | < 0.5 = TTL low<br>≥ 0.5 = TTL high |

### Driver Block Parameters

**Channel vector** — Enter numbers between 1 and 8 to select the digital output lines used with this port. This driver allows the selection of individual digital output lines in any order. The number of elements defines the number of digital lines used.

For example, to use all of the digital outputs for one port, enter

```
[1,2,3,4,5,6,7,8]
```

Number the lines beginning with 1 even if the board manufacturer starts numbering the lines with 0.

**Port** — From the list choose either A, B, or C. The I/O board has a 8255 chip with 3 ports. The **Port** parameter defines which port of the 8255 chip is used for this driver block. Each port has a maximum of 8 digital lines that can be configured as inputs or outputs depending on which driver block is chosen. In each case, one block is needed for each port.

**Reset vector** — The reset vector controls the behavior of the channel at model termination. Enter a scalar or a vector that is the same length as the channel vector. If you specify a scalar value, that setting is used for all channels. If you specify a value of 1, the corresponding channel is reset to the value specified in the initial value vector. If you specify a value of 0, the channel remains at the last value attained while the model was running.

**Initial value vector** — The initial value vector contains the initial values (0 or 1) of the output channels. Enter a scalar or a vector that is the same length as the channel vector. If you enter a scalar, that value is used for all channels. The channels are set to these initial values between the time the model is downloaded and the time it is started.

**Chip** — From the list choose 1, 2, 3, or 4.

**Sample time** - Enter a base sample time or a multiple of the base sample time.

**PCI Slot (-1:autosearch)** — If only one board of this type is physically present in the target PC, enter

-1

to automatically locate the board.

If two or more boards of this type are physically present in the target PC, enter the bus number and the PCI slot number of the board associated with this driver block. Use the format [BusNumber, SlotNumber]. To determine the bus number and the PCI slot number, type

`getxpcpci`

## PXI-6527

The PXI-6527 is an I/O board with 24 filtered digital input lines and 24 digital output lines. You can individually turn input filtering on or off for each of the 24 input lines. However, there is only one filter time of all of the input lines that have filtering enabled.

xPC Target supports this board with these driver blocks:

- “PXI-6527 Digital Input” on page 22-185
- “PXI-6527 Digital Output” on page 22-187

### Board Characteristics

|                                 |                      |
|---------------------------------|----------------------|
| Board name                      | PXI-6527             |
| Manufacturer                    | National Instruments |
| Bus type                        | PXI                  |
| Access method                   | Memory mapped        |
| Multiple block instance support | Digital I/O: Yes     |
| Multiple board support          | Yes                  |

### PXI-6527 Digital Input

The PXI-6527 has one chip with 3 ports (A,B,C) for digital input. Each port has a maximum of 8 digital I/O lines. Use a separate driver block for each port.

---

**Note** The interrupt on change capability of this board is not used.

---

### Scaling of Input to Output

| Hardware Input | Block Input Data Type | Scaling                       |
|----------------|-----------------------|-------------------------------|
| OPTO           | Double                | $< 0.5 = 0$<br>$\geq 0.5 = 1$ |

### Driver Block Parameters

**Channel vector** — Enter numbers between 1 and 8 to select the digital input lines used with this port. This driver allows the selection of individual digital input lines in any order. The number of elements defines the number of digital lines used.

For example, to use all of the digital inputs for one port, enter

```
[1,2,3,4,5,6,7,8]
```

Number the lines beginning with 1 even though the board manufacturer starts numbering the lines with 0.

**Port** — From the list choose either A, B, or C. The **Port** parameter defines which port is used for this driver block. Each port has a maximum of 8 digital inputs. In each case, one block is needed for each port.

The documentation for this board from National Instruments labels these ports 0, 1, and 2.

**Filter vector** — This is a Boolean vector that selects which input lines to filter. For example, if you enter a **Channel vector** of [1,3,5], and you want to filter all three lines, enter

```
[1,1,1]
```

If you want to filter lines 1 and 5, but not line 3, then enter

```
[1,0,1]
```

If the filter vector is a single element, then it is scalar expanded to the same width as the **Channel vector**. In the example above, if the **Filter vector** is [0], it is expanded to [0,0,0]. Likewise, if the **Filter vector** is [1] it is expanded to [1,1,1].

**Filter interval** — Enter the time interval the hardware filter uses to determine a stable pulse. If the input pulse is shorter than this interval, it is ignored. There is only one filter interval for all filtered inputs, and if you filter on more than one digital input block for this board, you must enter the same **Filter interval** for all blocks.

A reasonable value for the **Filter interval** would be 200 to 300 us.

**Sample time** — Enter a base sample time or a multiple of the base sample time.

**PCI Slot (-1:autosearch)** — If only one board of this type is physically present in the target PC, enter

-1

to automatically locate the board.

If two or more boards of this type are physically present in the target PC, enter the bus number and the PCI slot number of the board associated with this driver block. Use the format [BusNumber, SlotNumber]. To determine the bus number and the PCI slot number, type

```
getxpcpci
```

## PXI-6527 Digital Output

The PXI-6527 has one chip with 3 ports (A,B,C) for digital output. Each port has a maximum of 8 digital output lines. Use a separate driver block for each port.

### Scaling of Input to Output

| Hardware Output | Block Output Data Type | Scaling                                                                       |
|-----------------|------------------------|-------------------------------------------------------------------------------|
| OPTO            | Double                 | <0.5 = OPTO is OFF, no current flowing<br>≥0.5 = OPTO is ON, current can flow |

### Driver Block Parameters

**Channel vector** — Enter numbers between 1 and 8 to select the digital output lines used with this port. This driver allows the selection of individual digital output lines in any order. The number of elements defines the number of digital lines used.

For example, to use all of the digital outputs for one port, enter

```
[1,2,3,4,5,6,7,8]
```

Number the lines beginning with 1 even though the board manufacturer starts numbering the lines with 0.

**Port** — From the list choose either A, B, or C. The **Port** parameter defines which port is used for this driver block. Each port has a maximum of 8 digital output lines. In each case, one block is needed for each port.

The documentation for this board from National Instruments labels these ports 3, 4, and 5.

**Reset vector** — The reset vector controls the behavior of the channel at model termination. Enter a scalar or a vector that is the same length as the channel vector. If you specify a scalar value, that setting is used for all channels. If you specify a value of 1, the corresponding channel is reset to the value specified in the initial value vector. If you specify a value of 0, the channel remains at the last value attained while the model was running.

**Initial value vector** — The initial value vector contains the initial voltage values for the output channels. Enter a scalar or a vector that is the same length as the channel vector. If you specify a scalar value, that value is the initial value for all channels. The channels are set to the initial values between the time the model is downloaded and the time it is started.

**Sample time** — Enter a base sample time or a multiple of the base sample time.

**PCI Slot (-1:autosearch)** — If only one board of this type is physically present in the target PC, enter

-1

to automatically locate the board.

If two or more boards of this type are physically present in the target PC, enter the bus number and the PCI slot number of the board associated with this driver block. Use the format [BusNumber, SlotNumber]. To determine the bus number and the PCI slot number, type

```
getxpcpci
```

## PXI-6704

The PXI-6704 is an I/O board with 16 voltage outputs, 16 current outputs, and 8 digital I/O lines.

xPC Target supports this board with this driver block:

- “PXI-6704 Analog Output (D/A)” on page 22-189

### Board Characteristics

|                                 |                      |
|---------------------------------|----------------------|
| Board name                      | PXI-6704             |
| Manufacturer                    | National Instruments |
| Bus type                        | PCI                  |
| Access method                   | Memory mapped        |
| Multiple block instance support | No                   |
| Multiple board support          | Yes                  |

## PXI-6704 Analog Output (D/A)

### Scaling Input to Output

| Hardware Output | Block Input Data Type | Scaling |
|-----------------|-----------------------|---------|
| volts           | Double                | 1       |

### Driver Block Parameters

**Channel vector** — Enter numbers between 1 and 32. Channels 1-16 refer to the voltage output channels, and 17-32 the current output channels. The number of elements defines the number of D/A channels used. For example, to use the first and second analog output (D/A) channels, enter

[1,2]

Number the channels beginning with 1 even if the board manufacturer starts numbering the channels with 0.

**Sample time** — Base sample time or a multiple of the base sample time.

**PCI Slot (-1:autosearch)** — If only one board of this type is physically present in the target PC, enter

-1

to automatically locate the board.

If two or more boards of this type are physically present in the target PC, enter the bus number and the PCI slot number of the board associated with this driver block. Use the format [BusNumber, SlotNumber]. To determine the bus number and the PCI slot number, type

`getxpcpci`



# North Atlantic Industries, Inc. (Formerly Apex)

---

This chapter describes the North Atlantic Industries, Inc. (NAII) I/O boards supported by xPC Target (<http://www.naii.com>).

|                              |                                                                                                                                                                              |
|------------------------------|------------------------------------------------------------------------------------------------------------------------------------------------------------------------------|
| PC-12SD (PC-77SD1) (p. 23-2) | I/O board with up to 12 input channels for positioning sensors of type Synchro or Resolver.                                                                                  |
| NAII (Apex) 73LD3 (p. 23-5)  | I/O board with up to 6 input channels for LVDT/RVDT position sensors. The capabilities of this board vary according to its part number designation.                          |
| NAII (Apex) 73SD3 (p. 23-8)  | I/O board with up to six Synchro/Resolver-to-digital channels. The capabilities of this board vary according to its part number designation.                                 |
| NAII (Apex) 76LD1 (p. 23-12) | I/O board with up to 12 2-wire or up to six 3-wire or 4-wire stimulus (output) channels for LVDT/RVDT position sensors.                                                      |
| NAII (Apex) 76CL1 (p. 23-15) | I/O board with up to eight 2-wire or up to four 3-wire or 4-wire LVDT/RVDT measurement (input) channels for LVDT/RVDT position sensors.                                      |
| NAII (Apex) 76CS1 (p. 23-21) | I/O board with up to 8 synchro/resolver measurement (input, S/D) channels and up to six stimulus (output, D/S) channels for positioning sensors of type Synchro or Resolver. |

## PC-12SD (PC-77SD1)

The PC-12SD is an I/O board with up to 12 input channels for positioning sensors of type Synchro or Resolver. The manufacturer individually programs the board according to the order code or board code. Values for some of the block parameters with this driver depend on this board code.

xPC Target supports this board with this driver:

- “PC-12SD (PC-77SD1) Synchro/Resolver” on page 23-2

### Board Characteristics

|                                 |            |
|---------------------------------|------------|
| Board name                      | PC-12SD    |
| Manufacturer                    | Apex (NAA) |
| Bus type                        | ISA        |
| Access method                   | I/O mapped |
| Multiple block instance support | No         |
| Multiple board support          | Yes        |

## PC-12SD (PC-77SD1) Synchro/Resolver

### Scaling Input to Output

| Hardware Input      | Block Input Data Type | Scaling                          |
|---------------------|-----------------------|----------------------------------|
| Synchro or Resolver | Double                | angle in rad,<br>velocity in rps |

### Driver Block Parameters

**Channel vector** — Enter numbers between 1 and 12 to select the Synchro/Resolver (S/D) channels you use with this block. The driver allows the selection of individual S/D channels in any order, but repeating channels is not allowed. For example, to use the first and second S/D channels, enter

[1,2]

Number channels beginning with 1 even if the board manufacturer starts numbering channels with 0.

**Sensor type vector (0:resolver, 1:synchro)** — If the board code allows switching between Synchro or Resolver inputs, use this vector to define which type of sensor is attached to the corresponding channel. The vector has to have the same length as the **Channel vector**. Use a value 0 to specify Resolver input, and a value 1 to specify Synchro input. If the board code stands for a static type of sensor, enter an empty vector ( []).

**Ratio vector** — Enter numbers between 1 and 255 to define the ratio for each channel. This vector has to have the same length as the **Channel vector**. For single speed input, use a ratio value of 1. For double speed input the ratio depends on your sensor and application and can have a value between 2 and 255. In the case of double speed input, two channels are used to provide fine and coarse data.

**Output format** — From the list, choose Angle, Angle-Status, Angle-Velocity, or Angle-Velocity-Status. This is the output format for each S/D channel and also the format for the output port of this block. The possible selections are:

- Angle — The signal width is 1. This scalar is the angular position in radians.
- Angle - Status — The signal width is 2. The first element is the angular position, and the second element is the status.
- Angle - Velocity — The signal width is 2. The first element is the angular position, and the second element is the angular velocity. The unit for the angular velocity is revolutions/second (rps).
- Angle - Velocity - Status — The signal width is 3. The first element is the angular position, the second element the angular velocity, and the third element is the status.

The status signal returns information about test status, signal status and reference status for each S/D channel. Each status returns binary information (0 is OK, 1 is FAILURE). The test status has weight  $2^0$ , signal status has weight  $2^1$ , and the reference status has weight  $2^2$ .

For example, a status value of 5, means the test status is OK and both signal status and reference status are FAILURE.

Note, if you do not provide a **Reference Vector** by entering an empty matrix, the reference status is not returned. See the board manual for more information about statuses.

**Velocity scaling (max. RPS) vector** — Enter a scale factor for defining the maximum rotations/second (rps) for each S/D channel. You need to enter a value to read velocity information. This vector has to have the same length as the **Channel vector**. The values entered here define the maximum revolutions/second and affect the accuracy of the velocity readings. Choose values to have the best accuracy.

**Show input ports for dynamic velocity scaling** — Selecting this check box allows you to update the **Velocity scaling vector** at runtime.

If checked, the block shows the same number of input ports as output ports. That is, one port for each selected S/D channel. The signal width of each input port is 1. You can use the signal entering the corresponding input port to update the **Velocity scaling vector**. Even if you select this check box and you provide values to the input ports, you still have to enter a **Velocity scaling vector**. In this case, the **Velocity scaling vector** defined the initial values.

**Reference vector (frequency, voltage)** — If the board code includes the Reference Output option, you can use this vector to define the frequency and amplitude of the reference output. If you enter an empty matrix ([ ]), the reference output circuit is not accessed, even if the board is equipped with it.

To activate the reference output, you have to enter a row vector with two elements, where the first element defines the frequency in Hertz and the second element defines the output voltage in Volts.

**Sample time** - Enter the base sample time or a multiple of the base sample time. The sample time indicates the update rate of registration on the input (Duty Cycle)

**Base address** -Enter the base address of the board. This entry must corresponds to the DIP-switch settings on the board. For example, if the base address is 300 (hexadecimal), enter

0x300

## NAII (Apex) 73LD3

The NAII (Apex) 73LD3 is an I/O board with up to six input channels for LVDT/RVDT position sensors. The capabilities of this board vary according to its part number designation. There can be 2, 4, or 6 channels. The board might contain an on-board reference. If this reference is present, the supported frequency range is board dependent. The acceptable ranges of values for the driver block parameters vary according to board type.

xPC Target supports this board with this driver:

- “73LD3 LVDT/RVDT Converter” on page 23-5

xPC Target does not support the digital I/O functionality of this board.

### Board Characteristics

|                                 |            |
|---------------------------------|------------|
| Board name                      | 73LD3      |
| Manufacturer                    | Apex       |
| Bus type                        | ISA        |
| Access method                   | I/O mapped |
| Multiple block instance support | No         |
| Multiple board support          | Yes        |

### 73LD3 LVDT/RVDT Converter

#### Scaling Input to Output

| Hardware Input | Block Output Data Type | Scaling        |
|----------------|------------------------|----------------|
| LVDT or RVDT   | Double                 | -32768...32767 |

### **Driver Block Parameters**

**Channel vector** — Enter a vector of numbers to specify the input channels. For example, to use the first three analog input (A/D) channels, enter

[1, 2, 3]

The channel numbers can occur in any order. Number them beginning with 1 even if the board manufacturer numbers them beginning with 0. The maximum allowable channel number can be 2, 4, or 6 depending on the board type.

**Signal scale vector** — For 2 wire applications, enter the transformation ratio so that the full range of motion results in a full scale output signal from -32768 through 32767. For 3 or 4 wire applications, a setting of 65535 results in a full scale output signal. This scale factor can be chosen for each channel independently. If a scalar value is entered, it is applied to all channels.

**Velocity scale vector** — Enter the velocity (strokes/s or rev/s) that results in an output signal equal to 32767, the maximum 16-bit integer. This scale factor can be chosen for each channel independently. If a scalar value is entered, it is applied to all channels.

**Show input ports for dynamic velocity scaling** — Select this check box if you want to be able to update the velocity scale vector at run-time. If this check box is selected, the block displays one input port for each output channel selected. These input ports are all of width 1 and can be used to update the velocity scale vector dynamically. Even if you select this check box and provide values to the input ports, you still must enter a velocity scale vector to specify the initial values.

**Output format** — From the list select an output format for all channels:

- **position** — A signal width of 1 that contains the linear position.
- **position-status** — A signal width of 2 that contains the linear position and status.
- **position-velocity** — A signal width of 2 the contains the linear position and velocity.
- **position-velocity-status** — A signal width of 3 that contains the linear position, velocity, and status.

The following notes apply to these formats:

- The position and velocity values are each normalized to lie between -1 and 1.
- Position and velocity are returned in radians and radians per second, respectively.
- The status value is encoded in a 3-bit integer that is returned as a double. The status value consists of the following status information for the channel:
  - test status, weight of  $2^0$
  - signal status, weight of  $2^1$
  - reference status, weight of  $2^2$

Each status is a binary value (0 is OK, 1 is FAILURE). The driver encodes these binary values into a single signal. For example, a status value of 5 (100), means the test status is OK and both signal status and reference status are FAILURE. If the board does not provide a reference/excitation, the test status and reference status have no effect.

When you request a format with status, you also enable the automatic background (bit D2 of the Test Enable Register) testing.

**Wiring** — From the list, select either 2 wire or 3 or 4 wire.

**Excitation frequency (Hz)** — Enter the reference frequency of the board in hertz. Note that the possible ranges of reference frequencies depend on the board type and the jumper settings on the board.

**Excitation voltage (RMS)** — Enter the reference root-mean-square voltage value. Note that the possible ranges of reference voltages depend on the board type.

**Sample time** — Enter the base sample time or a multiple of the base sample time.

**Base address** — Enter the base address of the board. Be sure that this corresponds to the actual DIP-switch settings on the board. For example, if the base address is 300 in hexadecimal, enter

0x300

## **NAII (Apex) 73SD3**

The NAII (Apex) 73SD3 is an I/O board with up to six Synchro/Resolver-to-digital channels. The capabilities of this board vary according to its part number designation. There can be 2, 4, or 6 channels. The board might contain an on-board reference. If this reference is present, the supported frequency range is board dependent. The acceptable ranges of values for the driver block parameters vary according to board type.

xPC Target supports this board with one driver block:

- “NAII 73SD3 Synchro/Resolver” on page 23-9

### **Board Characteristics**

|                                 |               |
|---------------------------------|---------------|
| Board name                      | 73SD3         |
| Manufacturer                    | NAII          |
| Bus type                        | ISA           |
| Access method                   | Memory mapped |
| Multiple block instance support | No            |
| Multiple board support          | Yes           |



## NAII 73SD3 Synchro/Resolver

### Scaling Input to Output

| Hardware Input      | Block Output Data Type | Scaling                                       |
|---------------------|------------------------|-----------------------------------------------|
| Synchro or Resolver | Double                 | position: radians<br>velocity: radians/second |

### Driver Block Parameters

**Channel vector** — Enter a vector of numbers to specify the measurement (input) channels. For example, to use the Synchro/Resolver channels 1 and 4, enter

[ 1, 4 ]

The channel numbers can occur in any order. The maximum allowable channel number can be 2, 4, or 6 depending on the board type.

**Two-speed ratio vector (1: single speed; greater than 1: two-speed)** — Enter a two-speed ratio vector of integers greater than 0. This must be either a scalar or a vector the same length as the channel vector.

The two-speed ratio is normally 1 unless you are using a contiguous odd-even channel pair (such as 3 and 4) as a single two-speed channel. In this case, the two-speed ratio represents the gear ratio between the odd (coarse) and even (fine) channels of the pair. Include only the even member of a two-speed channel pair in the channel vector. For example, if you want to use channels 3 and 4 as a two-speed channel geared in the ratio of 36:1, perform the following:

- Add the value 4 (but not the value 3) to the **Channel vector** value
- Set the corresponding **Two-speed ratio vector** value to 36

**High resolution vector (0: 16-bit; 1:24-bit)** — Enter a high resolution vector for the channels. This must be a scalar or a vector the same length as the **Channel vector** value. Enter one of the following values:

- 0 — Specifies a 16-bit channel
- 1 — Specifies a 24-bit channel

Note, you can specify high resolution only for the even-numbered channels of a two-speed channel pair. Specifying high resolution incurs a small additional overhead.

**Encoder vector (4, 6, 8: commutator poles; 12-16: encoder bits)** — Enter a scalar or a vector that is the same length as the **Channel vector** value. The encoder vector controls the encoder or commutation outputs on connector JP5. Enter values according to the following:

- **Commutator** — Enter values from the set [4 6 8]. These values specify the number of poles for a commutator output.
- **Encoder** — Enter values from the set [12 13 14 15 16]. These values specify the number of bits for an encoder output.

**Output format** — From the list select an output format for all channels:

- **position** — A signal width of 1 that contains the linear position.
- **position-status** — A signal width of 2 that contains the linear position and status.
- **position-velocity** — A signal width of 2 the contains the linear position and velocity.
- **position-velocity-status** — A signal width of 3 that contains the linear position, velocity, and status.

The following notes apply to these formats:

- The position and velocity values are each normalized to lie between -1 and 1.
- Position and velocity are returned in radians and radians per second, respectively.
- The status value is encoded in a 3-bit integer that is returned as a double. The status value consists of the following status information for the channel:
  - test status, weight of  $2^0$
  - signal status, weight of  $2^1$
  - reference status, weight of  $2^2$

Each status is a binary value (0 is OK, 1 is FAILURE). The driver encodes these binary values into a single signal. For example, a status value of 5 (100), means the test status is OK and both signal status and reference

status are FAILURE. If the board does not provide a reference/excitation, the test status and reference status have no effect.

When you request a format with status, you also enable the automatic background (bit D2 of the Test Enable Register) testing.

**Max RPS vector** — Enter the maximum measurable velocity (in revolutions per second) for each channel. This value sets the velocity scale for each channel. This value must be a scalar or a vector that is the same length as the **Channel vector** value. Enter positive numbers less than 152.

**Show input ports for dynamic max RPS** - Select this check box to display an input port for each channel to be used for specifying the maximum RPS dynamically. When you select this check box, the input port signal is internally limited to between 9.5367 and 152.5878 RPS.

**Latch all channels before reading position data** — Select this check box to guarantee that all channels are latched before being read. This ensures that all channels are sampled at exactly the same time. Note that selecting this option incurs a small additional resource overhead.

**Excitation frequency (47-10000)** — Enter the frequency of the on-board reference/excitation.

**Excitation voltage (0, 2-28, or 115)** — Enter the voltage of the on-board reference/excitation.

**Sample time** — Enter the base sample time or a multiple of the base sample time.

**Base address** — Enter the base address of the board. Be sure that this corresponds to the actual DIP-switch settings on the board. For example, if the base address is 300 in hexadecimal, enter

0x300

## NAII (Apex) 76LD1

The NAII (Apex) 76LD1 is an I/O board with up to 12 2-wire or up to six 3-wire or 4-wire stimulus (output) channels. The capabilities of this board vary according to its part number designation. The board might contain an on-board reference. If this reference is present, the supported frequency range is board dependent. The acceptable ranges of values for the driver block parameters vary according to board type.

xPC Target supports this board with one driver block:

- “NAII 76LD1 L/D” on page 23-12

### Board Characteristics

|                                 |               |
|---------------------------------|---------------|
| Board name                      | 76LD1         |
| Manufacturer                    | NAII          |
| Bus type                        | PCI           |
| Access method                   | Memory mapped |
| Multiple block instance support | No            |
| Multiple board support          | Yes           |

### NAII 76LD1 L/D

#### Scaling Input to Output

| Hardware Input | Block Output Data Type | Scaling |
|----------------|------------------------|---------|
| LVDT or RVDT   | Double                 | -1...1  |

#### Driver Block Parameters

**Channel vector** — Enter a vector of numbers to specify the measurement (input) channels. For example, to use the L/D channels 1 and 3, enter

[1, 3]

The channel numbers can occur in any order. The maximum allowable channel number can be 0, 2, 4, or 8 depending on the board type.

**Wiring vector (2 for 2-wire;3 for 3-wire or 4-wire)** — Enter the wire type for each of the channels in **Channel vector**. This entry must be either a scalar or a vector that is the same length as the **Channel vector** entry. Specify the wiring vector as follows:

- 2 — Specifies that the corresponding channel is 2-wire
- 3 — Specifies that the corresponding channel is 3-wire or 4-wire

For example, for a **Channel vector** entry of [ 1, 3 ], a **Wiring vector** entry of [ 2, 3 ]

specifies that channel 1 is 2-wire and channel 3 is 3-wire or 4-wire.

**Output format** — From the list select an output format for all channels:

- position — A signal width of 1 that contains the linear position.
- position-status — A signal width of 2 that contains the linear position and status.
- position-velocity — A signal width of 2 the contains the linear position and velocity.
- position-velocity-status — A signal width of 3 that contains the linear position, velocity, and status.

The following notes apply to these formats:

- The position and velocity values are each normalized to lie between -1 and 1.
- Position and velocity are returned in radians and radians per second, respectively.
- The status value is encoded in a 3-bit integer that is returned as a double. The status value consists of the following status information for the channel:
  - test status, weight of  $2^0$
  - signal status, weight of  $2^1$
  - reference status, weight of  $2^2$

Each status is a binary value (0 is OK, 1 is FAILURE). The driver encodes these binary values into a single signal. For example, a status value of 5

(100), means the test status is OK and both signal status and reference status are FAILURE. If the board does not provide a reference/excitation, the test status and reference status have no effect.

When you request a format with status, you also enable the automatic background (bit D2 of the Test Enable Register) testing.

**Latch all channels before reading position data** — Select this check box to guarantee that all channels are latched before being read. This ensures that all channels are sampled at exactly the same time. Note that selecting this option incurs a small additional resource overhead.

**Excitation frequency (360-10000)** — Enter the frequency for the on-board reference/excitation signal.

**Excitation voltage (0, 2-28, or 115)** — Enter the voltage of the on-board reference/excitation signal.

**Sample time** — Enter the base sample time or a multiple of the base sample time.

**PCI Slot (-1:autosearch)** — If only one board of this type is physically present in the target PC, enter

-1

to automatically locate the board.

If two or more boards of this type are physically present in the target PC, enter the bus number and the PCI slot number of the board associated with this driver block. Use the format [BusNumber, SlotNumber]. To determine the bus number and the PCI slot number, type

```
getxpcpci
```

Note that the device ID of the NAI 76LD1 board is 7631 in hexadecimal.

## NAII (Apex) 76CL1

The NAII (Apex) 76CL1 I/O board provides up to eight 2-wire or up to four 3-wire or 4-wire LVDT/RVDT measurement (input) channels. It also provides up to 12 2-wire or up to six 3-wire or 4-wire stimulus (output) channels. The capabilities of this board vary according to its part number designation. The board might contain an on-board reference. If this reference is present, the supported frequency range is board dependent. The acceptable ranges of values for the driver block parameters vary according to board type.

xPC Target supports this board with two driver blocks:

- “NAII 76CL1 L/D” on page 23-15
- “NAII 76CL1 D/L” on page 23-18

### Board Characteristics

|                                 |               |
|---------------------------------|---------------|
| Board name                      | 76CL1         |
| Manufacturer                    | NAII          |
| Bus type                        | PCI           |
| Access method                   | Memory mapped |
| Multiple block instance support | No            |
| Multiple board support          | Yes           |

### NAII 76CL1 L/D

#### Scaling Input to Output

| Hardware Input | Block Output Data Type | Scaling |
|----------------|------------------------|---------|
| LVDT or RVDT   | Double                 | -1...1  |

#### Driver Block Parameters

**Channel vector** — Enter a vector of numbers to specify the stimulus (output) channels. For example, to use the L/D channels 1 and 3, enter

[1, 3]

The channel numbers can occur in any order. The maximum allowable channel number can be 0, 2, 4, or 8 depending on the board type.

**Wiring vector (2 for 2-wire;3 for 3-wire or 4-wire)** — This must be either a scalar or a vector the same length as the **Channel vector** value. Enter a value of 2 to indicate that the corresponding channel is 2-wire. Enter a value of 3 to indicate the corresponding channel is 3-wire or 4-wire. For example, a **Channel vector** value of [1,3] and a wiring vector setting of

[2, 3]

indicates that channel 1 is 2-wire and that channel 3 is 3-wire or 4-wire.

**Output format** — From the list select an output format for all channels:

- position — A signal width of 1 that contains the linear position.
- position-status — A signal width of 2 that contains the linear position and status.
- position-velocity — A signal width of 2 the contains the linear position and velocity.
- position-velocity-status — A signal width of 3 that contains the linear position, velocity, and status.

The following notes apply to these formats:

- The position and velocity values are each normalized to lie between -1 and 1.
- Position and velocity are returned in radians and radians per second, respectively.
- The status value is encoded in a 3-bit integer that is returned as a double. The status value consists of the following status information for the channel:
  - test status, weight of  $2^0$
  - signal status, weight of  $2^1$
  - reference status, weight of  $2^2$

Each status is a binary value (0 is OK, 1 is FAILURE). The driver encodes these binary values into a single signal. For example, a status value of 5 (100), means the test status is OK and both signal status and reference



status are FAILURE. If the board does not provide a reference/excitation, the test status and reference status have no effect.

When you request a format with status, you also enable the automatic background (bit D2 of the Test Enable Register) testing.

**Latch all channels before reading position data** — Select this check box to guarantee that all channels are latched before being read. This ensures that all channels are sampled at exactly the same time. Note that selecting this option incurs a small additional resource overhead.

**Excitation frequency (360-10000)** — Enter the frequency of the on-board reference/excitation.

**Excitation voltage (0, 2-28, or 115)** — Enter the voltage of the on-board reference/excitation.

**Sample time** — Enter the base sample time or a multiple of the base sample time.

**PCI slot** — If only one board of this type is physically present in the target PC, enter

- 1

to automatically locate the board.

If two or more boards of this type are physically present in the target PC, enter the bus number and the PCI slot number of the board associated with this driver block. Use the format [BusNumber, SlotNumber]. To determine the bus number and the PCI slot number, type

```
getxpcpci
```

Note that the device ID of the NAII 76CL1 board is 7651 in hexadecimal.

## NAII 76CL1 D/L

### Scaling Input to Output

| Hardware Input | Block Output Data Type | Scaling |
|----------------|------------------------|---------|
| LVDT/RVDT      | Double                 | -1...1  |

### Driver Block Parameters

**Channel vector** — Enter a vector of numbers to specify the stimulus (output) channels. For example, to use the D/L channels 1 and 3, enter

[1, 3]

The channel numbers can occur in any order. The maximum allowable channel number can be 0, 2, 4, or 6 depending on the board type.

If a channel  $n$  is configured as a 2-wire channel pair (as specified in the **Wiring vector** parameter), enter the A and B subchannels in **Channel vector** as  $n$  and  $-n$ , respectively. For example, if all channels are configured as 2-wire, the **Channel vector** value

[1, -1, 2, -2, 3, -3, 4, -4, 5, -5, 6, -6]

refers to channels 1A, 1B, 2A, 2B, and so on in that order.

**Reset vector** — Enter a scalar or a vector that is the same length as the **Channel vector** value. The reset vector controls the behavior of the channel at model termination. If you specify a scalar value, that setting is used for all channels. If you specify a value of 1, the corresponding channel resets to the value specified in the initial value vector. If you specify a value of 0, the channel remains at the last value attained while the model was running.

**Initial value vector** — Enter a scalar or a vector that is the same length as the **Channel vector** value. The initial value vector contains the initial voltage values (in the range -1 to 1) for the output channels. If you specify a scalar value, that value is the initial value for all channels. The channels are set to the initial values between the time the model is downloaded and the time it is started.

**Wiring vector (2 for 2-wire;3 for 3-wire or 4-wire)** — Enter the wire type for each of the channels in **Channel vector**. This entry must be either a scalar or a vector that is the same length as the **Channel vector** entry. Specify the wiring vector as follows:

- 2 — Specifies that the corresponding channel is 2-wire
- 3 — Specifies that the corresponding channel is 3-wire or 4-wire

Note that if a channel is 2-wire, you can specify A and B subchannels (as described for the **Channel vector** parameter).

For example, a **Channel vector** of

[5, 6]

and a **Wiring vector** value of

[2, 3]

indicates that channel 5 is 2-wire and channel 6 is 3-wire or 4-wire. In this channel vector, 5 refers to channel 5A. Channel 6, because it 3-wire or 4-wire, does not have this distinction. The corresponding input port on the block changes its label to 5A when you click **Apply** or **OK**.

On the other hand, the channel vector

[-5, 6]

designates channels 5B and 6.

**Transformation ratio vector** — Enter the transformation ratio vector for the channels specified in the **Channel vector** value. This entry must be either a scalar or a vector that is the same length as the **Channel vector** value. Enter a ratio within the range 0-2. For 2-wire channels, the transformation ratio applies to both A and B channels.

**Show output status port** — Select this check box to enable the automatic background (bit D2 of the Test Enable Register) testing. This option displays a status output port labeled **S** when you click **Apply** or **OK**. This port emits a signal with a width of 3. The signal contains the following words for the board:

- test status
- signal status
- excitation status

**Excitation frequency (360-10000)** — Enter the frequency of the on-board reference/excitation.

**Excitation voltage (0, 2-28, or 115)** — Enter the voltage of the on-board reference/excitation.

**Sample time** — Enter the base sample time or a multiple of the base sample time.

**PCI slot** — If only one board of this type is physically present in the target PC, enter

- 1

to automatically locate the board.

If two or more boards of this type are physically present in the target PC, enter the bus number and the PCI slot number of the board associated with this driver block. Use the format [BusNumber, SlotNumber]. To determine the bus number and the PCI slot number, type

```
getxpcpci
```

Note that the device ID of the NAI 76CL1 board is 7651 in hexadecimal.

## NAII (Apex) 76CS1

The NAII (Apex) 76CS1 I/O board provides up to 8 synchro/resolver measurement (input, S/D) channels and up to six stimulus (output, D/S) channels. The capabilities of this board vary according to its part number designation. The board might contain an on-board reference. If this reference is present, the supported frequency range is board dependent.

xPC Target supports this board with two driver blocks:

- “NAII 76CS1 S/D” on page 23-21
- “NAII 76CS1 D/S” on page 23-25

### Board Characteristics

|                                 |               |
|---------------------------------|---------------|
| Board name                      | 76CS1         |
| Manufacturer                    | NAII          |
| Bus type                        | PCI           |
| Access method                   | Memory mapped |
| Multiple block instance support | No            |
| Multiple board support          | Yes           |

### NAII 76CS1 S/D

#### Scaling Input to Output

| Hardware Input      | Block Output Data Type | Scaling                                       |
|---------------------|------------------------|-----------------------------------------------|
| Synchro or Resolver | Double                 | position: radians<br>velocity: radians/second |

#### Driver Block Parameters

**Channel vector** — Enter a vector of numbers to specify the input channels. For example, to use the measurement (S/D) channels 1 and 4, enter

[1, 4]

The channel numbers can occur in any order. The maximum allowable channel number can be 0, 2, 4, or 8 depending on the board type.

**Two-speed ratio vector (1: single speed; greater than 1: two-speed)** — Enter a two-speed ratio vector of integers greater than 0. This must be either a scalar or a vector the same length as the **Channel vector** value.

The two-speed ratio is normally 1 unless you are using a contiguous odd-even channel pair (such as 3 and 4) as a single two-speed channel. In this case, the two-speed ratio represents the gear ratio between the odd (coarse) and even (fine) channels of the pair. Include only the even member of a two-speed channel pair in the **Channel vector**. For example, if you want to use channels 3 and 4 as a two-speed channel geared in the ratio of 36:1, perform the following:

- Add the value 4 (but not the value 3) to the **Channel vector** value
- Set the corresponding **Two-speed ratio vector** value to 36

**High resolution vector (0: 16-bit; 1:24-bit)** — Enter a high resolution vector for the channels. This must be a scalar or a vector the same length as the **Channel vector** value. Enter one of the following values:

- 0 — Specifies a 16-bit channel
- 1 — Specifies a 24-bit channel

Note, you can specify high resolution only for the even-numbered channels of a two-speed channel pair. Specifying high resolution incurs a small additional overhead.

**Synchro vector** — Enter a value to indicate that a channel is synchro or resolver. This value must be a scalar or a vector that is the same length as the **Channel vector** value. For each channel, enter

- 1 to indicate that the corresponding channel is a synchro
- 0 to indicate that it is a resolver

**Encoder vector (4, 6, 8: commutator poles; 12-16: encoder bits)** — Enter a scalar or a vector that is the same length as the **Channel vector** value. The encoder vector controls the encoder or commutation outputs on connector JP5. Enter values according to the following:

- **Commutator** — Enter values from the set [4 6 8]. These values specify the number of poles for a commutator output.

**Encoder** — Enter values from the set [12 13 14 15 16]. These values specify the number of bits for an encoder output.

**Output format** — From the list select an output format for all channels:

- **position** — A signal width of 1 that contains the linear position.
- **position-status** — A signal width of 2 that contains the linear position and status.
- **position-velocity** — A signal width of 2 that contains the linear position and velocity.
- **position-velocity-status** — A signal width of 3 that contains the linear position, velocity, and status.

The following notes apply to these formats:

- The position and velocity values are each normalized to lie between -1 and 1.
- Position and velocity are returned in radians and radians per second, respectively.
- The status value is encoded in a 3-bit integer that is returned as a double. The status value consists of the following status information for the channel:
  - test status, weight of  $2^0$
  - signal status, weight of  $2^1$
  - reference status, weight of  $2^2$

Each status value is a binary value (0 is OK, 1 is FAILURE). The driver encodes these binary values into a single signal. For example, a status value of 5 (100), means the test status is OK and both signal status and reference status are FAILURE. If the board does not provide a reference/excitation, the test status and reference status have no effect.

When you request a format with status, you also enable the automatic background (bit D2 of the Test Enable Register) testing.

**Max RPS vector** — Enter the maximum measurable velocity (in revolutions per second) for each channel. This value sets the velocity scale for each channel. This value must be a scalar or a vector that is the same length as the **Channel vector** value. Enter positive numbers less than 152.

**Show input ports for dynamic max RPS** - Select this check box to display an input port for each channel to be used for specifying the maximum RPS dynamically. When you select this check box, the input port signal is internally limited to between 9.5367 and 152.5878 RPS.

**Latch all channels before reading position data** — Select this check box to guarantee that all channels are latched before being read. This ensures that all channels are sampled at exactly the same time. Note that selecting this option incurs a small additional resource overhead.

**Save board setup at model termination (takes 5 seconds)** — Select this check box to save the current board settings to the board at model termination. This action takes approximately 5 seconds. Wait for the save action to complete before removing power from the board. Upon save completion, the message

Setup has been saved

appears in the message window on the upper right of the target PC screen.

**Excitation frequency (47-1000)** — Enter the frequency of the on-board reference/excitation.

**Excitation voltage (0, 2-28, or 115)** — Enter the voltage of the on-board reference/excitation.

**Sample time** — Enter the base sample time or a multiple of the base sample time.

**PCI slot** — If only one board of this type is physically present in the target PC, enter

- 1

to automatically locate the board.

If two or more boards of this type are physically present in the target PC, enter the bus number and the PCI slot number of the board associated with this driver block. Use the format [BusNumber, SlotNumber]. To determine the bus number and the PCI slot number, type

```
getxpcpci
```

Note that the device ID of the NAI 76CS1 board is 7621 in hexadecimal.



## NAII 76CS1 D/S

### Scaling Input to Output

| Hardware Input      | Block Output Data Type | Scaling |
|---------------------|------------------------|---------|
| Synchro or Resolver | Double                 | radians |

### Driver Block Parameters

**Channel vector** — Enter a vector of numbers to specify the stimulus (output) channels. For example, to use the D/S channels 1 and 3, enter

[ 1, 3 ]

The channel numbers can occur in any order. The maximum allowable channel number can be 0, 2, 4, or 6 depending on the board type.

**Reset vector** — Enter a scalar or a vector that is the same length as the **Channel vector** value. The reset vector controls the behavior of the channel at model termination. If you specify a scalar value, that setting is used for all channels. If you specify a value of 1, the corresponding channel resets to the value specified in the initial value vector. If you specify a value of 0, the channel remains at the last value attained while the model was running.

**Initial value vector** — Enter a scalar or a vector that is the same length as the channel vector. The initial value vector contains the initial values (in radians) for the output channels. If you specify a scalar value, that value is the initial value for all channels. The channels are set to the initial values between the time the model is downloaded and the time it is started.

**Two-speed ratio vector (1: single speed; greater than 1: two-speed)** — Enter a two-speed ratio vector of integers greater than 0. This must be either a scalar or a vector the same length as the channel vector.

The two-speed ratio is normally 1 unless you are using a contiguous odd-even channel pair (such as 3 and 4) as a single two-speed channel. In this case, the two-speed ratio represents the gear ratio between the odd (coarse) and even (fine) channels of the pair. Include only the even member of a two-speed channel pair in the channel vector. For example, if you want to use channels 3 and 4 as a two-speed channel geared in the ratio of 36:1, perform the following:

- Add the value 4 (but not the value 3) to the **Channel vector** value
- Set the corresponding **Two-speed ratio vector** value to 36

**High resolution vector (0: 16-bit; 1:24-bit)** — Enter a high resolution vector for the channels. This must be a scalar or a vector the same length as the **Channel vector** value. Enter one of the following values:

- 0 — Specifies a 16-bit channel
- 1 — Specifies a 24-bit channel

Note, you can specify high resolution only for the even-numbered channels of a two-speed channel pair. Specifying high resolution incurs a small additional overhead.

**Show output status port** — Select this check box to enable the automatic background (bit D2 of the Test Enable Register) testing. This option displays a status output port labeled **S** when you click **Apply** or **OK**. This port emits a signal with a width of 3. The signal contains the following words for the board:

- test status
- signal status

excitation status

**Excitation frequency (47-10000)** — Enter the frequency of the on-board reference/excitation.

**Excitation voltage (0, 2-28, or 115)** — Enter the voltage of the on-board reference/excitation.

**Sample time** — Enter the base sample time or a multiple of the base sample time.

**PCI slot** — If only one board of this type is physically present in the target PC, enter

- 1

to automatically locate the board.

If two or more boards of this type are physically present in the target PC, enter the bus number and the PCI slot number of the board associated with this driver block. Use the format [BusNumber, SlotNumber]. To determine the bus number and the PCI slot number, type

`getxpcpci`

Note that the device ID of the NAII 76CS1 board is 7621 in hexadecimal.



# Quanser

---

This chapter describes I/O boards supported by xPC Target (<http://www.quanser.com>).

Q8 (p. 24-2)

Multifunction measurement and control board with eight 14-bit singled-ended A/D converters, eight 12-bit D/A voltage outputs, 32 digital communication channels, eight 24-bit encoder inputs, and two 32-bit counter/timers.

## Q8

The Quanser Q8 is a multifunction measurement and control board. It has eight 14-bit singled-ended A/D converters (supported by two A/D chips with four channels per chip), eight 12-bit D/A voltage outputs, 32 digital communication channels (each of which can be used for digital input or digital output), eight 24-bit encoder inputs, and two 32-bit counter/timers.

xPC Target supports this board with these driver blocks:

- “Q8 Analog Input” on page 24-2
- “Q8 Analog Output” on page 24-4
- “Q8 Digital Input” on page 24-6
- “Q8 Digital Output” on page 24-7
- “Q8 Incremental Encoder” on page 24-8
- “Q8 Counter” on page 24-11

### Board Characteristics

|                                 |               |
|---------------------------------|---------------|
| Board name                      | Q8            |
| Manufacturer                    | Quanser       |
| Bus type                        | PCI           |
| Access method                   | Memory mapped |
| Multiple block instance support | No            |
| Multiple board support          | Yes           |

### Q8 Analog Input

#### Scaling of Input to Output

| Hardware Input | Block Output Data Type | Scaling |
|----------------|------------------------|---------|
| volts          | Double                 | 1       |

## Driver Block Parameters

**Channel vector** — Enter a vector of numbers between 1 and 8. This driver allows you to enter channel numbers in any order. For example, to use the first, second and fifth channels, enter

```
[1,2,5]
```

Number the channels beginning with 1 even if the board manufacturer starts numbering the channels with 0. Note that the input range is -10V to 10V for all channels and is not reconfigurable.

Two A/D chips on the Q8 board convert these channels. One A/D chip converts channels 1 to 4, the second A/D chip converts channels 5 to 8. To maximize throughput, balance the conversion load between the two groups of channels. For example, if you want to convert four channels, a channel vector value like the following has one A/D chip convert channels 1 and 2 and the other A/D chip convert channels 5 and 6:

```
[1, 2, 5, 6]
```

**Sample time** — Base sample time or a multiple of the base sample time.

**PCI slot** — If only one board of this type is physically present in the target PC, enter

```
-1
```

to automatically locate the board.

If two or more boards of this type are physically present in the target PC, enter the bus number and the PCI slot number of the board associated with this driver block. Use the format [BusNumber, SlotNumber]. To determine the bus number and the PCI slot number, type

```
getxpcpci
```

Note that the Device ID of the Quanser Q8 board is 0x0010.

## Q8 Analog Output

### Scaling of Input to Output

| Hardware Output | Block Input Data Type | Scaling |
|-----------------|-----------------------|---------|
| volts           | Double                | 1       |

**Channel vector** — Enter a vector of numbers between 1 and 8. This driver allows you to enter channel numbers in any order. For example, to use the first, second and fifth channels, enter

```
[1,2,5]
```

Number the channels beginning with 1 even if the board manufacturer starts numbering the channels with 0.

Two A/D chips on the Q8 board convert these channels. One A/D chip converts channels 1 to 4, the second A/D chip converts channels 5 to 8. To maximize throughput, balance the conversion load between the two groups of channels. For example, if you want to convert four channels, a channel vector value like the following has one A/D chip convert channels 1 and 2 and the other A/D chip convert channels 5 and 6:

```
[1, 2, 5, 6]
```

**Range vector** — Enter a range code for each of the channels in the channel vector. The value can be a scalar or a vector that must be the same length as the channel vector. If you specify a scalar value, that setting is used for all channels. This board allows the range of each channel to be different.

The following table is a list of the ranges for this driver and the corresponding range codes.

| Input Range (V) | Range Code |
|-----------------|------------|
| -10 to +10      | -10        |
| -5 to +5        | -5         |
| 0 to 10         | 10         |



For example, if the first channel is -10 to +10 volts, and the second channel is 0 to 5 volts, enter

```
[ -10,5]
```

**Simultaneous update** — Choose this check box to ensure that all the outputs update simultaneously (non-transparent mode).

Note that choosing this check box requires an extra register write per sample time and might cause some performance loss.

**Reset vector** — The reset vector controls the behavior of the channel at model termination. Enter a scalar or a vector that is the same length as the channel vector. If you specify a scalar value, that setting is used for all channels. If you specify a value of 1, the corresponding channel is reset to the value specified in the initial value vector. If you specify a value of 0, the channel remains at the last value attained while the model was running.

**Initial value vector** — The initial value vector contains the initial voltage values for the output channels. Enter a scalar or a vector that is the same length as the channel vector. If you specify a scalar value, that value is the initial value for all channels. The channels are set to the initial values between the time the model is downloaded and the time it is started.

**Sample time** — Base sample time or a multiple of the base sample time.

**PCI slot** — If only one board of this type is physically present in the target PC, enter

```
-1
```

to automatically locate the board.

If two or more boards of this type are physically present in the target PC, enter the bus number and the PCI slot number of the board associated with this driver block. Use the format [BusNumber, SlotNumber]. To determine the bus number and the PCI slot number, type

```
getxpcpci
```

Note that the Device ID of the Quanser Q8 board is 0x0010.

## Q8 Digital Input

### Scaling of Input to Output

| Hardware Input | Block Output Data Type | Scaling                 |
|----------------|------------------------|-------------------------|
| TTL            | Double                 | TTL low=0<br>TTL high=1 |

### Driver Block Parameters

**Channel vector** — Enter a vector of numbers between 1 and 32. This driver allows you to enter channel numbers in any order. For example, to use the first, second and fifth digital channels for input, enter

[1,2,5]

Number the channels beginning with 1 even if the board manufacturer starts numbering the channels with 0.

The Q8 board has 32 digital channels. You can use each of these digital channels for input or output.

---

**Note** If you have a Q8 digital input and digital output block corresponding to the same board (the same PCI slot), do not use the same digital channel number in both blocks.

---

**Sample time** — Base sample time or a multiple of the base sample time.

**PCI slot** — If only one board of this type is physically present in the target PC, enter

-1

to automatically locate the board.

If two or more boards of this type are physically present in the target PC, enter the bus number and the PCI slot number of the board associated with this driver block. Use the format [BusNumber, SlotNumber]. To determine the bus number and the PCI slot number, type

```
getxpcpci
```

Note that the Device ID of the Quanser Q8 board is 0x0010.

## Q8 Digital Output

### Scaling of Input to Output

| Hardware Input | Block Output Data Type | Scaling |
|----------------|------------------------|---------|
| volts          | Double                 | 1       |

### Driver Block Parameters

**Channel vector** — Enter a vector of numbers between 1 and 32. This driver allows you to enter channel numbers in any order. For example, to use the first, second and fifth digital channels for input, enter

```
[1,2,5]
```

Number the channels beginning with 1 even if the board manufacturer starts numbering the channels with 0.

The Q8 board has 32 digital channels. You can use each of these digital channels for input or output.

---

**Note** If you have a Q8 digital input and digital output block corresponding to the same board (the same PCI slot), do not use the same digital channel number in both blocks.

---

**Reset vector** — The reset vector controls the behavior of the channel at model termination. Enter a scalar or a vector that is the same length as the channel vector. If you specify a scalar value, that setting is used for all channels. If you specify a value of 1, the corresponding channel is reset to the value specified in the initial value vector. If you specify a value of 0, the channel remains at the last value attained while the model was running.

**Initial value vector** — The initial value vector contains the initial voltage values for the output channels. Enter a scalar or a vector that is the same length as the channel vector. If you specify a scalar value, that value is the initial value for all channels. The channels are set to the initial values between the time the model is downloaded and the time it is started.

**Sample time** — Base sample time or a multiple of the base sample time.

**PCI slot** — If only one board of this type is physically present in the target PC, enter

-1

to automatically locate the board.

If two or more boards of this type are physically present in the target PC, enter the bus number and the PCI slot number of the board associated with this driver block. Use the format [BusNumber, SlotNumber]. To determine the bus number and the PCI slot number, type

```
getxpcpci
```

Note that the Device ID of the Quanser Q8 board is 0x0010.

## Q8 Incremental Encoder

**Channel vector** — Enter a vector of numbers between 1 and 8. This driver allows you to enter channel numbers in any order. For example, to use the first three odd encoder input channels, enter

```
[1,3,5]
```

Number the channels beginning with 1 even if the board manufacturer starts numbering the channels with 0.

---

**Note** If you specify four channels or less, it is more efficient to use channels that are all odd or all even. Doing so ensures optimal performance.

---

**Initial count vector** — The initial value vector contains valid count values to be loaded into the preload register (PR) for the corresponding channel. After a counter decrements to zero, it reloads from the value in the preload register.

Enter a scalar or a vector that is the same length as the channel vector. If you specify a scalar value, that value is the initial count value for all channels.

**Prescale vector** — The prescale vector is a base prescale factor for digital filtering. Enter a scalar or a vector that is the same length as the channel vector. If you specify a scalar value, that setting is used for all channels. This filter clock frequency helps eliminate high frequency noise. Enter a value from 0 to 255. An entry of 0 corresponds to the highest possible available frequency of 16.7 MHz.

**Quadrature vector** — Enter the quadrature vector. Enter a scalar or a vector that is the same length as the channel vector. If you specify a scalar value, that setting is used for all channels. The allowable entries are

- 0 — Non-quadrature or normal. The driver treats the A input as count and the B input as direction.
- 1 — 1X quadrature. Counts up or down once per complete cycle of the quadrature signal
- 2 — 2X quadrature. Counts up or down twice per complete cycle of the quadrature signal
- 4 — 4X quadrature. Counts up or down four times per complete cycle of the quadrature signal

**Mode vector** — Enter the counting mode. Enter a scalar or a vector that is the same length as the channel vector. If you specify a scalar value, that setting is used for all channels. The allowable entries are

- 0 — Normal. The counter wraps from 0 to 0xFFFFFFFF when decrementing and from 0xFFFFFFFF to 0 when incrementing.
- 1 — Range Limit. The counter freezes upon reaching 0 from above and upon reaching the preload register (PR) value from below. In both cases, once counting has stopped, the counter resumes only when the count direction reverses.
- 2 — Non-recycle. Counting stops upon overflow or underflow and does not resume.
- 3 — Modulo-N. This mode is similar to Normal mode except that the maximum count is specified by the preload register (PR).

**Synchronous index vector** — Enter the synchronous index vector. Enter a scalar or a vector that is the same length as the channel vector. If you specify a scalar value, that setting is used for all channels. The allowable entries are

- 0 — Disables index mode. This mode treats the index/load (I/LD) input as a level-sensitive asynchronous input.
- 1 — Enables index mode. This mode treats the index/load (I/LD) input as a level-sensitive synchronous input with the quadrature clocks.

**Index polarity vector** — Enter the index polarity mode vector. Enter a scalar or a vector that is the same length as the channel vector. If you specify a scalar value, that setting is used for all channels. The allowable entries are

- 0 — Active Low, for a negative slope
- 1 — Active High, for a positive slope

**Preserve counts vector** — Enter the preserve counts vector. Enter a scalar or a vector that is the same length as the channel vector. If you specify a scalar value, that setting is used for all channels. The allowable entries are

- 0 — Do not preserve the current count for the corresponding channel. The driver loads its counter from its preload register (PR) when the model is restarted.
- 1 — Preserve the current count for the corresponding channel when the model is restarted. (Note that the count will be meaningless after power is recycled.)

**Sample time** — Base sample time or a multiple of the base sample time.

**PCI slot** — If only one board of this type is physically present in the target PC, enter

-1

to automatically locate the board.

If two or more boards of this type are physically present in the target PC, enter the bus number and the PCI slot number of the board associated with this driver block. Use the format [BusNumber, SlotNumber]. To determine the bus number and the PCI slot number, type

```
getxpcpci
```

Note that the Device ID of the Quanser Q8 board is 0x0010.

## Q8 Counter

**Channel vector** — Enter a vector of numbers containing 1 or 2. This driver allows you to enter channel numbers in any order. Channel 1 references the counter channel, channel 2 references the watchdog channel. For example, to use both channels, enter

```
[1,2]
```

**Mode vector** — Enter the display port mode. Enter a scalar or a vector that is the same length as the channel vector. If you specify a scalar value, that setting is used for all channels. The allowable entries are

- 0 — Frequency Modulation (FM). Display a single input port for the corresponding channel. This port dynamically specifies the lengths (in 30 nanosecond units) of both the low and high phases of a square wave output over the channel.
- 1 — Pulse Width Modulation (PWM). Display a *lo* and a *hi* input port for each corresponding channel. These port dynamically specifies the lengths (in 30 nanosecond units) of the low and high phases respectively of a rectangular wave output over the channel.

**Show arm input vector** — Enter a scalar or a vector that is the same length as the channel vector. If you specify a scalar value, that setting is used for all channels. The allowable entries are

- 0 — Do not display the input arm input. The channel is always armed.
- 1 — Display the input arm input for the associated channel. This setting allows a channel to be armed or disarmed. You can use this port to enable or disable the channel output dynamically. To enable or disable the channel output, connect a signal to the input arm input. A signal value of 1 enables the channel output, a value of 0 disables the channel output.

When you disarm a channel, its output is continuously high. When you arm a channel, the corresponding input port(s) control the output, as usual.

The value of an input port is undefined for the time between when a model is downloaded and the time it is started. If an input port is armed, its initial value is determined by the corresponding **Initial low count vector** and **Initial high count vector** values:

- If either the **Initial low count vector** or **Initial high count vector** value is nonzero, the channel will be armed between download time and model start time
- If both the **Initial low count vector** or **Initial high count vector** value is zero, the channel will be disarmed.

**Reset vector** — The reset vector controls the behavior of the channel at model termination. Enter a scalar or a vector that is the same length as the channel vector. If you specify a scalar value, that setting is used for all channels. If you specify a value of 1, the corresponding channel is reset to the value specified in the initial value vector. If you specify a value of 0, the channel remains at the last value attained while the model was running.

**Initial low count vector** — This parameter specifies the initial width (the time after model download and prior to model start) in 30 nanosecond intervals of the low portion of the output signal for the corresponding channel. Enter a scalar or a vector that is the same length as the channel vector. If you specify a scalar value, that setting is used for all channels.

**Initial high count vector** — This parameter specifies the initial width (the time after model download and prior to model start) in 30 nanosecond intervals of the high portion of the output signal for the corresponding channel. Enter a scalar or a vector that is the same length as the channel vector. If you specify a scalar value, that setting is used for all channels.

**Sample time** — Base sample time or a multiple of the base sample time.

**PCI slot** — If only one board of this type is physically present in the target PC, enter

-1

to automatically locate the board.



If two or more boards of this type are physically present in the target PC, enter the bus number and the PCI slot number of the board associated with this driver block. Use the format [BusNumber, SlotNumber]. To determine the bus number and the PCI slot number, type

```
getxpcpci
```

Note that the Device ID of the Quanser Q8 board is 0x0010.



# Real Time Devices

---

This chapter describes I/O boards supported by xPC Target (<http://www.rtdusa.com>).

|                   |                                                                                                                                                                                               |
|-------------------|-----------------------------------------------------------------------------------------------------------------------------------------------------------------------------------------------|
| DM6420 (p. 25-2)  | I/O board with 16 single or 8 differential analog input (A/D) channels, 2 analog output (D/A) channels, 8 independent digital I/O lines, 8 dependent digital I/O lines, and 2 counter/timers. |
| DM6430 (p. 25-9)  | ISA PC/104 I/O board with 16 single or 8 differential analog input (A/D) channels, 1 analog output (D/A) channel, 16 digital I/O lines, and 2 counter/timers.                                 |
| DM6604 (p. 25-15) | ISA PC/104 I/O board with 8 analog output (D/A) channels, and 24 digital I/O lines.                                                                                                           |
| DM6804 (p. 25-19) | ISA PC/104 I/O board with 24 digital I/O lines and 5 counter/timer channels.                                                                                                                  |
| DM6814 (p. 25-30) | 16-bit counting board with 3 channels. This board typically connects to incremental encoders.                                                                                                 |
| DM6816 (p. 25-34) | ISA PC/104 I/O board with 9 independent PWM channels, 8-bit resolution, 3 16-bit timer/counters, and an on-board 8 MHz clock.                                                                 |
| DM7420 (p. 25-36) | PCI PC/104 I/O board with 16 single or 8 differential analog input (A/D) channels, 8 independent digital I/O lines, 8 dependent digital I/O lines, and 9 counter/timers.                      |

## DM6420

The DM6420 is an I/O board with 16 single or 8 differential analog input (A/D) channels (12-bit) with a maximum sample rate of 500 kHz, 2 analog output (D/A) channels (12-bit), 8 independent digital I/O lines, 8 dependent digital I/O lines, and 2 counter/timers (16-bit).

xPC Target supports this board with these driver blocks:

- “DM6420 Analog Input (A/D)” on page 25-3
- “DM6420 Analog Output (D/A)” on page 25-5
- “DM6420 Digital Input” on page 25-6
- “DM6420 Digital Output” on page 25-7

---

**Note** xPC Target does not support the counter/timers on this board.

---

### Board Characteristics

|                                 |                   |
|---------------------------------|-------------------|
| Board name                      | DM6420            |
| Manufacturer                    | Real Time Devices |
| Bus type                        | ISA (PC104)       |
| Access method                   | I/O mapped        |
| Multiple block instance support | No                |
| Multiple board support          | Yes               |

## DM6420 Analog Input (A/D)

### Scaling Input to Output

| Hardware Input | Block Output Data Type | Scaling |
|----------------|------------------------|---------|
| volts          | Double                 | 1       |

### Driver Block Parameters

**Channel vector** — Enter numbers between 1 and 16. This driver allows the selection of individual A/D channels in any order. The number of elements defines the number of A/D channels used.

For example, to use the first, second and fifth channels, enter

```
[1,2,5]
```

Number the channels beginning with 1 even if the board manufacturer starts numbering the channels with 0.

**Input coupling vector** — Enter either 1 (single-ended) or 2 (differential) for each of the channels in the channel vector to choose the coupling code. The coupling vector must be the same length as the channel vector. This driver allows the coupling of each channel to be different.

For example, if the first and second channels are single-ended and the fifth channel is a differential input, enter

```
[1,1,2]
```

The driver selects a second differential input 8 channels higher than the first channel. In the example above, the driver would select the thirteenth channel as a differential input with the fifth channel.

**Range vector** — Enter a range code for each of the channels entered in the channel vector. The range vector must be the same length as the channel vector. This driver allows a different range for each channel.

The following table is a list of the ranges for this driver and the corresponding range codes.

| Input Range (V) | Range Code | Input Range (V) | Range Code |
|-----------------|------------|-----------------|------------|
| -10 to +10      | -10        | 0 - 10          | 10         |
| -5 to +5        | -5         | 0 - 5           | 5          |

For example, if the first channel is -10 to + 10 volts and the second and fifth channels are 0 to +5 volts, enter

[ -10,5,5]

**Gain vector** — Enter 1, 2, 4, or 8 for each of the channels in the channel vector to choose the gain code of that channel. The gain vector must be the same length as the channel vector. This driver allows the gain of each channel to be different.

**Note** While this board has programmable input ranges of  $\pm 5$ ,  $\pm 10$  and 0 to 10, this driver sets the input range to +10, and then lets you select different input ranges by choosing different gains.

The following table is a list of the ranges for this driver given the gain entered in the gain vector.

| Gain | Range (V)     |
|------|---------------|
| 1    | -10 to 10     |
| 2    | -5 to +5      |
| 4    | -2.5 to 2.5   |
| 8    | -1.25 to 1.25 |

Notice that by increasing the gain code the voltage range is decreased. The gain divides the input voltage range.

For example, if the first channel has a gain code of 1 (10 volt range) and the second and fifth channels have a gain code of 2 (5 volt range), enter

[1,2,2]

**Sample time** — Base sample time of a multiple of the base sample time.

**Base address** — Enter the base address of the board. It is important that this entry corresponds to the DIP-switch settings on the board. For example, if the base address is 300 (hexadecimal), enter

0x300

## DM6420 Analog Output (D/A)

### Scaling of Input to Output

| Hardware Output | Block Input Data Type | Scaling |
|-----------------|-----------------------|---------|
| volts           | Double                | 1       |

### Driver Block Parameters

**Channel vector** — Enter numbers between 1 and 8 to select the analog output (D/A) channels used. This driver allows the selection of individual channels in any order. The number of elements defines the number of D/A channels used.

For example, to use the first, second and fifth channels, enter

[1,2,5]

Number the channels beginning with 1 even if the board manufacturer starts numbering the channels with 0.

**Range vector** — Enter a range code for each of the channels entered in the channel vector. The range vector must be the same length as the channel vector. This driver allows a different range for each channel.

The following table is a list of the ranges for this driver and the corresponding range codes.

| Input Range (V) | Range Code | Input Range (V) | Range Code |
|-----------------|------------|-----------------|------------|
| -10 to +10      | -10        | 0 - 10          | 10         |
| -5 to +5        | -5         | 0 - 5           | 5          |

For example, if the first channel is -10 to + 10 volts and the second and fifth channels are 0 to +5 volts, enter

[ - 10, 5, 5]

**Sample time** — Enter the model base sample time or a multiple of the base sample time.

**Base address** — Enter the base address of the board. It is important that this entry corresponds to the DIP-switch settings on the board. For example, if the base address is 300 (hexadecimal), enter

0x300

## DM6420 Digital Input

The DAS1601/16 has a 8255 chip with 3 ports (A,B,C). Each port has a maximum of 8 digital I/O lines that can be configured as inputs or outputs.

Use a separate driver block for each port. By selecting the digital input driver block, the port is configured as input.

### Scaling Input to Output

| Hardware Input | Block Output Data Type | Scaling                         |
|----------------|------------------------|---------------------------------|
| TTL            | Double                 | TTL low = 0.0<br>TTL high = 1.0 |



## Driver Block Parameters

**Channel vector** — Enter numbers between 1 and 8 to select the digital input lines used with this port. This driver allows the selection of individual digital input lines in any order. The number of elements defines the number of digital lines used.

For example, to use all of the digital inputs for one port, enter

```
[1,2,3,4,5,6,7,8]
```

Number the lines beginning with 1 even if the board manufacturer starts numbering the lines with 0.

**Port** — From the list choose either A, B, or C. The port name defines which port is used for this driver block. Each port has a maximum of 8 digital lines that can be configured as inputs. In each case, one block is needed for each port.

**Sample time** — Enter a base sample time or a multiple of the base sample time.

**Base address** — Enter the base address of the board. This entry must correspond to the DIP-switch settings on the board. For example, if the base address is 300 (hexadecimal), enter

```
0x300
```

## DM6420 Digital Output

The DAS1601/16 has an 8255 chip with 2 ports (1,2). Each port has a maximum of 8 digital I/O lines that can be configured as inputs or outputs.

Use a separate driver block for each port. By selecting the digital output driver block, the port is configured as output.

### Scaling Input to Output

| Hardware Output | Block Input Data Type | Scaling                             |
|-----------------|-----------------------|-------------------------------------|
| TTL             | Double                | < 0.5 = TTL low<br>≥ 0.5 = TTL high |

### Driver Block Parameters

**Channel vector** — Enter numbers between 1 and 8 to select the digital output lines used with this port. This driver allows the selection of individual digital output lines in any order. The number of elements defines the number of digital lines used.

For example, to use all of the digital outputs for one port, enter

[1,2,3,4,5,6,7,8]

Number the lines beginning with 1 even if the board manufacturer starts numbering the lines with 0.

**Port** — From the list choose either 1 or 2. The port name defines which port is used for this driver block. Each port has a maximum of 8 digital lines that can be configured as outputs. In each case, one block is needed for each port.

**Sample time** — Enter a base sample time or a multiple of the base sample time.

**Base address** — Enter the base address of the board. This entry must corresponds to the DIP-switch settings on the board. For example, if the base address is 300 (hexadecimal), enter

0x300

## DM6430

The DM6430 is an ISA PC/104 I/O board with 16 single or 8 differential analog input (A/D) channels (16-bit) with a maximum sample rate of 100 kHz, 1 analog output (D/A) channel (16-bit), 16 digital I/O lines, and 2 counter/timers (16-bit).

xPC Target supports this board with these driver blocks:

- “DM6430 Analog Input (A/D)” on page 25-9
- “DM6430 Analog Output (D/A)” on page 25-11
- “DM6430 Digital Input” on page 25-12
- “DM6430 Digital Output” on page 25-13

---

**Note** xPC Target does not support the counter/timers on this board.

---

### Board Characteristics

|                                 |                   |
|---------------------------------|-------------------|
| Board name                      | DM6430            |
| Manufacturer                    | Real Time Devices |
| Bus type                        | ISA (PC104)       |
| Access method                   | I/O mapped        |
| Multiple block instance support | No                |
| Multiple board support          | Yes               |

### DM6430 Analog Input (A/D)

#### Scaling Input to Output

| Hardware Input | Block Output Data Type | Scaling |
|----------------|------------------------|---------|
| volts          | Double                 | 1       |

**Driver Block Parameters**

**Channel vector** — Enter numbers between 1 and 16. This driver allows the selection of individual A/D channels in any order. The number of elements defines the number of A/D channels used.

For example, to use the first, second and fifth channels, enter

[ 1, 2, 5 ]

Number the channels beginning with 1 even if the board manufacturer starts numbering the channels with 0.

**Gain vector** — Enter 1, 2, 4, or 8 for each of the channels in the channel vector to choose the gain code of that channel. The gain vector must be the same length as the channel vector. This driver allows the gain of each channel to be different.

The following table is a list of the ranges for this driver given the gain entered in the gain vector.

| <b>Gain</b> | <b>Range (V)</b> |
|-------------|------------------|
| 1           | -10 to 10        |
| 2           | -5 to +5         |
| 4           | -2.5 to 2.5      |
| 8           | -1.25 to 1.25    |

Notice that by increasing the gain code the voltage range is decreased. The gain divides the input voltage range.

For example, if the first channel has a gain code of 1 (10 volt range) and the second and fifth channels have a gain code of 2 (5 volt range), enter

[ 1, 2, 2 ]

**Input coupling vector** — Enter either 1 (single-ended) or 2 (differential) for each of the channels in the channel vector to choose the coupling code. The coupling vector must be the same length as the channel vector. This driver allows the coupling of each channel to be different.

For example, if the first and second channels are single-ended and the fifth channel is a differential input, enter

```
[0,0,1]
```

The driver selects a second differential input 8 channels higher than the first channel. In the example above, the driver would select the thirteenth channel as a differential input with the fifth channel.

**Sample time** — Base sample time of a multiple of the base sample time.

**Base address** — Enter the base address of the board. It is important that this entry corresponds to the DIP-switch settings on the board. For example, if the base address is 300 (hexadecimal), enter

```
0x300
```

## DM6430 Analog Output (D/A)

### Scaling Input to Output

| Hardware Output | Block Input Data Type | Scaling |
|-----------------|-----------------------|---------|
| volts           | Double                | 1       |

### Driver Block Parameters

This board has 2 analog outputs (D/A) with a fixed range of -10 to +10 volts.

**Channel vector** — Enter 1 or 2 to select the digital output lines used with this port. This driver allows the selection of individual digital input lines in any order. The number of elements defines the number of digital lines used.

For example, to use all of the digital outputs for one port, enter

```
[1,2]
```

Number the lines beginning with 1 even if the board manufacturer starts numbering the lines with 0.

**Reset vector** — The reset vector controls the behavior of the channel at model termination. Enter a scalar or a vector that is the same length as the channel vector. If you specify a scalar value, that setting is used for all channels. If you

specify a value of 1, the corresponding channel is reset to the value specified in the initial value vector. If you specify a value of 0, the channel remains at the last value attained while the model was running.

**Initial value vector** — The initial value vector contains the initial voltage values for the output channels. Enter a scalar or a vector that is the same length as the channel vector. If you specify a scalar value, that value is the initial value for all channels. The channels are set to the initial values between the time the model is downloaded and the time it is started.

**Sample time** — Base sample time of a multiple of the base sample time.

**Base address** — Enter the base address of the board. It is important that this entry corresponds to the DIP-switch settings on the board. For example, if the base address is 300 (hexadecimal), enter

0x300

## DM6430 Digital Input

The DM6430 has an 8255 chip with 2 ports (1,2). Each port has a maximum of 8 digital I/O lines that can be configured as inputs or outputs.

Use a separate driver block for each port. By selecting the digital input driver block, the port is configured as input.

### Scaling Input to Output

| Hardware Input | Block Output Data Type | Scaling                         |
|----------------|------------------------|---------------------------------|
| TTL            | Double                 | TTL low = 0.0<br>TTL high = 1.0 |

### Driver Block Parameters

**Channel vector** — Enter numbers between 1 and 8 to select the digital input lines used with this port. This driver allows the selection of individual digital input lines in any order. The number of elements defines the number of digital lines used.

For example, to use all of the digital inputs for one port, enter

[1,2,3,4,5,6,7,8]

Number the lines beginning with 1 even if the board manufacturer starts numbering the lines with 0.

**Port** — From the list choose either 1 or 2. The port name defines which port is used for this driver block. Each port has a maximum of 8 digital lines that can be configured as inputs. In each case, one block is needed for each port.

**Sample time** — Enter a base sample time or a multiple of the base sample time.

**Base address** — Enter the base address of the board. This entry must correspond to the DIP-switch settings on the board. For example, if the base address is 300 (hexadecimal), enter

0x300

## DM6430 Digital Output

The DM6430 has a 8255 chip with 2 ports (1,2). Each port has a maximum of 8 digital I/O lines that can be configured as inputs or outputs.

Use a separate driver block for each port. By selecting the digital output driver block, the port is configured as output.

### Scaling Input to Output

| Hardware Output | Block Input Data Type | Scaling                             |
|-----------------|-----------------------|-------------------------------------|
| TTL             | Double                | < 0.5 = TTL low<br>≥ 0.5 = TTL high |

### Driver Block Parameters

**Channel vector** — Enter numbers between 1 and 8 to select the digital output lines used with this port. This driver allows the selection of individual digital output lines in any order. The number of elements defines the number of digital lines used.

For example, to use all of the digital outputs for one port, enter

[1,2,3,4,5,6,7,8]

Number the lines beginning with 1 even if the board manufacturer starts numbering the lines with 0.

**Port** — From the list choose either 1 or 2. The port name defines which port is used for this driver block. Each port has a maximum of 8 digital lines that can be configured as outputs. In each case, one block is needed for each port.

**Sample time** — Enter a base sample time or a multiple of the base sample time.

**Base address** — Enter the base address of the board. This entry must correspond to the DIP-switch settings on the board. For example, if the base address is 300 (hexadecimal), enter



## DM6604

The DM6604 is an ISA PC/104 I/O board with 8 analog output (D/A) channels (12-bit), and 24 digital I/O lines.

xPC Target supports this board with these driver blocks:

- “DM6604 Analog Output (D/A)” on page 25-15
- “DM6604 Digital Input” on page 25-16
- “DM6604 Digital Output” on page 25-17

### Board Characteristics

|                                 |                   |
|---------------------------------|-------------------|
| Board name                      | DM6604            |
| Manufacturer                    | Real Time Devices |
| Bus type                        | ISA (PC104)       |
| Access method                   | I/O mapped        |
| Multiple block instance support | Yes               |
| Multiple board support          | Yes               |

## DM6604 Analog Output (D/A)

### Scaling of Input to Output

| Hardware Output | Block Input Data Type | Scaling |
|-----------------|-----------------------|---------|
| volts           | Double                | 1       |

### Driver Block Parameters

**Channel vector** — Enter numbers between 1 and 8 to select the analog output (D/A) channels used. This driver allows the selection of individual channels in any order. The number of elements defines the number of D/A channels used.

For example, to use the first, second and fifth channels, enter

```
[1,2,5]
```

Number the channels beginning with 1 even if the board manufacturer starts numbering the channels with 0.

**Range vector** —Enter a range code for each of the channels entered in the channel vector. The range vector must be the same length as the channel vector. This driver allows a different range for each channel.

The following table is a list of the ranges for this driver and the corresponding range codes.

| <b>Input Range (V)</b> | <b>Range Code</b> | <b>Input Range (V)</b> | <b>Range Code</b> |
|------------------------|-------------------|------------------------|-------------------|
| -10 to +10             | -10               | 0 - 10                 | 10                |
| -5 to +5               | -5                | 0 - 5                  | 5                 |

For example, if the first channel is -10 to + 10 volts and the second and fifth channels are 0 to +5 volts, enter

[ -10,5,5]

**Sample time** — Enter the model base sample time or a multiple of the base sample time.

**Base address** — Enter the base address of the board. It is important that this entry corresponds to the DIP-switch settings on the board. For example, if the base address is 300 (hexadecimal), enter

0x300

## **DM6604 Digital Input**

**Channel vector** — Enter numbers between 1 and 8 to select the digital input lines used with this port. This driver allows the selection of individual digital input lines in any order. The number of elements defines the number of digital lines used.

For example, to use all of the digital inputs for one port, enter

[1,2,3,4,5,6,7,8]

Number the lines beginning with 1 even if the board manufacturer starts numbering the lines with 0.

**Port** — From the list choose either A, B, or C. The port name defines which port is used for this driver block. Each port has a maximum of 8 digital lines that can be configured as inputs. In each case, one block is needed for each port.

**Sample time** — Enter a base sample time or a multiple of the base sample time.

**Base address** — Enter the base address of the board. This entry must correspond to the DIP-switch settings on the board. For example, if the base address is 300 (hexadecimal), enter

0x300

## DM6604 Digital Output

**Channel vector** — Enter numbers between 1 and 8 to select the digital output lines used with this port. This driver allows the selection of individual digital output lines in any order. The number of elements defines the number of digital lines used.

For example, to use all of the digital outputs for one port, enter

[1,2,3,4,5,6,7,8]

Number the lines beginning with 1 even if the board manufacturer starts numbering the lines with 0.

**Port** — From the list choose either A, B, or C. The port name defines which port is used for this driver block. Each port has a maximum of 8 digital lines that can be configured as outputs. In each case, one block is needed for each port.

**Reset vector** — The reset vector controls the behavior of the channel at model termination. Enter a scalar or a vector that is the same length as the channel vector. If you specify a scalar value, that setting is used for all channels. If you specify a value of 1, the corresponding channel is reset to the value specified in the initial value vector. If you specify a value of 0, the channel remains at the last value attained while the model was running.

**Initial value vector** — The initial value vector contains the initial values (0 or 1) of the output channels. Enter a scalar or a vector that is the same length as the channel vector. If you enter a scalar, that value is used for all channels. The channels are set to these initial values between the time the model is downloaded and the time it is started.

**Sample time** — Enter a base sample time or a multiple of the base sample time.

**Base address** — Enter the base address of the board. This entry must corresponds to the DIP-switch settings on the board. For example, if the base address is 300 (hexadecimal), enter

0x300

## DM6804

The DM6804 is an ISA PC/104 I/O board with 24 digital I/O lines and 5 counter/timer channels (16-bit).

It contains one 8255 chip with 3 digital I/O ports and one AM9513A counter/timer chip. For additional information about the various counter/timer modes of that chip see the AM9513A data sheet which is part of the board documentation.

xPC Target supports this board with these driver blocks:

- “DM6804 Digital Input” on page 25-20
- “DM6804 Digital Output” on page 25-20
- “DM6804 Counter PWM” on page 25-21
- “DM6804 Counter PWM & ARM” on page 25-23
- “DM6804 Counter FM” on page 25-24
- “DM6804 Counter FM & ARM” on page 25-26
- “DM6804 PWM Capture” on page 25-27
- “DM6804 FM Capture” on page 25-28
- “DM6804xx” on page 25-29

### Board Characteristics

|                                 |                   |
|---------------------------------|-------------------|
| Board name                      | DM6804            |
| Manufacturer                    | Real Time Devices |
| Bus type                        | ISA               |
| Access method                   | I/O mapped        |
| Multiple block instance support | Yes               |
| Multiple board support          | Yes               |

## **DM6804 Digital Input**

The DM6804 has a 8255 chip with 3 ports (A, B, C). Each port has a maximum of 8 digital I/O lines that can be configured as inputs or outputs.

Use a separate driver block for each port. By selecting the digital input driver block, the port is configured as input.

**Channel vector** — Enter numbers between 1 and 8 to select the digital input lines used with this port. This driver allows the selection of individual digital input lines in any order. The number of elements defines the number of digital lines used.

For example, to use all of the digital inputs for one port, enter

```
[1,2,3,4,5,6,7,8]
```

Number the lines beginning with 1 even if the board manufacturer starts numbering the lines with 0.

**Port** — From the list choose either A, B, or C. The port name defines which port is used for this driver block. Each port has a maximum of 8 digital lines that can be configured as inputs. In each case, one block is needed for each port.

**Sample time** — Enter a base sample time or a multiple of the base sample time.

**Base address** — Enter the base address of the board. This entry must correspond to the DIP-switch settings on the board. For example, if the base address is 300 (hexadecimal), enter

```
0x300
```

## **DM6804 Digital Output**

The DM6804 has a 8255 chip with 3 ports (A, B, C). Each port has a maximum of 8 digital I/O lines that can be configured as inputs or outputs.

Use a separate driver block for each port. By selecting the digital output driver block, the port is configured as output.

**Channel vector** — Enter numbers between 1 and 8 to select the digital output lines used with this port. This driver allows the selection of individual digital output lines in any order. The number of elements defines the number of digital lines used.

For example, to use all of the digital outputs for one port, enter

```
[1,2,3,4,5,6,7,8]
```

Number the lines beginning with 1 even if the board manufacturer starts numbering the lines with 0.

**Port** — From the list choose either A, B, or C. The port name defines which port is used for this driver block. Each port has a maximum of 8 digital lines that can be configured as outputs. In each case, one block is needed for each port.

**Reset vector** — The reset vector controls the behavior of the channel at model termination. Enter a scalar or a vector that is the same length as the channel vector. If you specify a scalar value, that setting is used for all channels. If you specify a value of 1, the corresponding channel is reset to the value specified in the initial value vector. If you specify a value of 0, the channel remains at the last value attained while the model was running.

**Initial value vector** — The initial value vector contains the initial values (0 or 1) of the output channels. Enter a scalar or a vector that is the same length as the channel vector. If you enter a scalar, that value is used for all channels. The channels are set to these initial values between the time the model is downloaded and the time it is started.

**Sample time** — Enter a base sample time or a multiple of the base sample time.

**Base address** — Enter the base address of the board. This entry must correspond to the DIP-switch settings on the board. For example, if the base address is 300 (hexadecimal), enter

```
0x300
```

## DM6804 Counter PWM

The DM6804 has one AM9513A chip with 5 counters.

The DM6804 PWM driver programs the AM9513A for PWM (Pulse Width Modulation) signal generation (a square wave with fixed frequency and variable duty cycle). The block has one input which defines the variable duty cycle between 0 and 1. For the corresponding counter channel, the PWM signal is output at the pin named OUT.

### Scaling Input to Output

| Hardware Output | Block Input Data Type | Scaling |
|-----------------|-----------------------|---------|
| TTL             | Double                | 0 to 1  |

### Driver Block Parameters

**Counter** — From the list, choose 1, 2, 3, 4, or 5 to select which counter is used with this driver block. In each case, one block is needed for each counter.

**Frequency base** — From the list, choose F1=5MHz, F2=500kHz, F3=50kHz, F4=5kHz, or F5=500Hz to set the base frequency.

**Relative output frequency** — Enter a value between 0 and  $.25 \times \text{Frequency base}$ . The **Relative output frequency** is multiplied by the **Frequency base** to set the fixed output frequency of the PWM-signal.

For example, if the output frequency of a square wave has to be 87.5 kHz, then choose F2=500kHz as the Frequency Base and enter 0.175 as the Relative Output Frequency.  $500\text{kHz} \times 0.175 = 87.5 \text{ kHz}$

**Level sequence of square wave** — From the list, choose either high-low or low-high:

- If you choose high-low, the square wave period starts with the TTL high part followed by the TTL low part.
- If you choose low-high, the square wave period starts with the TTL low part followed by the TTL high part.

In either case, the duty cycle entering the block defines the duration of the TTL high part.

**Level when disarmed** — From the list, choose either high or low. The counter is automatically disarmed when the target application is not running and gets armed when the application begins running. This parameter sets the TTL level when the counter is disarmed.

**Sample time** — Enter the base sample time or a multiple of the base sample time. The sample time indicates the update rate of registration on the input (Duty Cycle)



**Base address** —Enter the base address of the board. This entry must correspond to the DIP-switch settings on the board. For example, if the base address is 300 (hexadecimal), enter

0x300

## DM6804 Counter PWM & ARM

The DM6804 has one AM9513A chip with 5 counters.

The DM6804 PWM & ARM driver programs the AM9513A for PWM or disarmed signal generation (a square wave with fixed frequency and variable duty cycle). Additionally the driver allows to arm and disarm the counter by the second block input. For the corresponding counter channel, the PWM signal is output at the pin named OUT.

### Scaling Input to Output

| Hardware Output | Block Input Data Type             | Scaling                               |
|-----------------|-----------------------------------|---------------------------------------|
| TTL             | Duty cycle: Double<br>Arm: Double | 0 to 1<br><0.5 disarmed<br>≥0.5 armed |

### Driver Block Parameters

**Counter** — From the list, choose 1, 2, 3, 4, or 5 to select which counter is used with this driver block. In each case, one block is needed for each counter.

**Frequency base** — From the list, choose F1=5MHz, F2=500kHz, F3=50kHz, F4=5kHz, or F5=500Hz to set the base frequency.

**Relative output frequency** — Enter a value between 0 and  $.25 \times \text{Frequency base}$ . The **Relative output frequency** is multiplied by the **Frequency base** to set the fixed output frequency of the PWM-signal.

For example, if the output frequency of a square wave has to be 87.5 kHz, then choose F2=500kHz as the Frequency Base and enter 0.175 as the Relative Output Frequency.  $500\text{kHz} \times 0.175 = 87.5\text{ kHz}$

**Level sequence of square wave** — From the list, choose either high-low or low-high:

- If you choose high - low, the square wave period starts with the TTL high part followed by the TTL low part.
- If you choose low - high, the square wave period starts with the TTL low part followed by the TTL high part.

In either case, the duty cycle entering the block defines the duration of the TTL high part.

**Level when disarmed** — From the list, choose either high or low. The counter is automatically disarmed when the target application is not running. If the application is running, the second input port controls whether the counter is armed or disarmed. This parameter sets the TTL level when the counter is disarmed.

**Sample time** — Enter the base sample time or a multiple of the base sample time. The sample time indicates the update rate of registration on the input (Duty Cycle)

**Base address** — Enter the base address of the board. This entry must corresponds to the DIP-switch settings on the board. For example, if the base address is 300 (hexadecimal), enter

0x300

## **DM6804 Counter FM**

The DM6804 has one AM9513A chip with 5 counters.

The DM6804 FM driver programs the AM9513A for FM (Frequency Modulation) signal generation (a square wave with fixed duty cycle and variable frequency). For the corresponding counter channel, the PWM signal is output at the pin named OUT.

## Scaling Input to Output

| Hardware Output | Block Input Data Type | Scaling |
|-----------------|-----------------------|---------|
| TTL             | Double                | 0 to 1  |

## Driver Block Parameters

**Counter** — From the list, choose 1, 2, 3, 4, or 5 to select which counter is used with this driver block. In each case, one block is needed for each counter.

**Frequency base** — From the list, choose F1=5MHz, F2=500kHz, F3=50kHz, F4=5kHz, or F5=500Hz to set the base frequency.

**Output duty cycle** — Enter a value between 0 and 1 to set the duty cycle of the square wave. The Duty Cycle is held fixed during execution of the target application.

---

**Note** Your control over the output duty cycle is not always precise. See “PWM and FM Driver Block Notes” on page 1-8 for details.

---

**Level sequence of square wave** — From the list, choose either high-low or low-high:

- If you choose high-low, the square wave period starts with the TTL high part followed by the TTL low part.
- If you choose low-high, the square wave period starts with the TTL low part followed by the TTL high part.

In either case, the duty cycle entering the block defines the duration of the TTL high part.

**Level when disarmed** — From the list, choose either high or low. The counter is automatically disarmed when the target application is not running and gets armed when the application begins running. This parameter sets the TTL level when the counter is disarmed.

**Sample time** — Enter the base sample time or a multiple of the base sample time. The sample time indicates the update rate of registration on the input (Duty Cycle)

**Base address** — Enter the base address of the board. This entry must correspond to the DIP-switch settings on the board. For example, if the base address is 300 (hexadecimal), enter

0x300

## DM6804 Counter FM & ARM

The DM6804 has one AM9513A chip with 5 counters.

The DM6804 FM & ARM driver programs the AM9513A for FM (Frequency Modulation) signal generation (a square wave with fixed duty cycle and variable frequency). Additionally the driver allows to arm and disarm the counter by the second block input. For the corresponding counter channel, the PWM signal is output at the pin named OUT.

### Scaling Input to Output

| Hardware Output | Block Input Data Type                     | Scaling                     |
|-----------------|-------------------------------------------|-----------------------------|
| TTL             | Variable frequency: Double<br>Arm: Double | <0.5 disarmed<br>≥0.5 armed |

### Driver Block Parameters

**Counter** — From the list, choose 1, 2, 3, 4, or 5 to select which counter is used with this driver block. In each case, one block is needed for each counter.

**Frequency base** — From the list, choose F1=5MHz, F2=500kHz, F3=50kHz, F4=5kHz, or F5=500Hz to set the base frequency. The XTAL frequency is assumed to be 1MHz, therefore the jumper on the DM6804 has to be in position 1MHz not 5MHz.

**Output duty cycle** — Enter a value between 0 and 1 to set the duty cycle of the square wave. The Duty Cycle is held fixed during execution of the target application.

---

**Note** Your control over the output duty cycle is not always precise. See “PWM and FM Driver Block Notes” on page 1-8 for details.

---

**Level sequence of square wave** — From the list, choose either high-low or low-high:

- If you choose high-low, the square wave period starts with the TTL high part followed by the TTL low part.
- If you choose low-high, the square wave period starts with the TTL low part followed by the TTL high part.

In either case, the **Output duty cycle** defined in the setting above define the duration of the TTL high part.

**Level when disarmed** — From the list, choose either high or low. The counter is automatically disarmed when the target application is not running. If the application is running, the second input port controls whether the counter is armed or disarmed. This parameter sets the TTL level when the counter is disarmed.

**Sample time** — Enter the base sample time or a multiple of the base sample time. The sample time indicates the update rate of registration on the input (Duty Cycle)

**Base address** — Enter the base address of the board. This entry must corresponds to the DIP-switch settings on the board. For example, if the base address is 300 (hexadecimal), enter

0x300

## DM6804 PWM Capture

This block programs the AMD9513A for capturing PWM signals by using two counters. One counter measures the cycle duration, and the other counter measures the duration the signal is high.

There are two outputs. One output is the relative frequency compared to the base frequency. The other output is the duty cycle. To get the actual frequency, multiply the base frequency by the relative frequency.

The PWM signal has to enter the pins named GATE of both corresponding counter channels (parallel wiring). Both CLK pins have to be left unconnected.

### Scaling Input to Output

| Hardware Output | Block Input Data Type | Scaling |
|-----------------|-----------------------|---------|
| TTL             | Double                | 0 to 1  |

### Driver Block Parameters

**Counter** — From the list, choose 1&2, 2&3, 3&4, 4&5. This selects which two counters the driver block uses to determine the PWM. In each case, one block is needed for each counter.

**Frequency base** — From the list, choose F1=5MHz, F2=500kHz, F3=50kHz, F4=5kHz, or F5=500Hz to set the base frequency. The XTAL frequency is assumed to be 1MHz, therefore the jumper on the DM6804 has to be in position 1MHz not 5MHz.

**Sample time** — Enter the base sample time or a multiple of the base sample time. The sample time indicates the update rate of registration on the input (Duty Cycle)

**Base address** — Enter the base address of the board. This entry must corresponds to the DIP-switch settings on the board. For example, if the base address is 300 (hexadecimal), enter

0x300

### DM6804 FM Capture

This block programs the AMD9513A for capturing FM signals.

There is one output for relative frequency compared to the base frequency. To get the actual frequency, multiply the base frequency by the relative frequency.

The FM signal has to enter the pin named GATE of the corresponding counter channel. The CLK pin has to be left unconnected.

## Scaling Input to Output

| Hardware Output | Block Input Data Type | Scaling |
|-----------------|-----------------------|---------|
| TTL             | Double                | 0 to 1  |

## Driver Block Parameters

**Counter** — From the list, choose 1, 2, 3, 4, or 5. This selects which counter the driver block uses to determine the FM. In each case, one block is needed for each counter.

**Frequency base** — From the list, choose F1=5MHz, F2=500kHz, F3=50kHz, F4=5kHz, or F5=500Hz to set the base frequency.

**Sample time** — Enter the base sample time or a multiple of the base sample time. The sample time indicates the update rate of registration on the input (Duty Cycle)

**Base address** — Enter the base address of the board. This entry must corresponds to the DIP-switch settings on the board. For example, if the base address is 300 (hexadecimal), enter

0x300

## DM6804xx

You can use this block to program the AMD9513A counter. The PWM, PWM & ARM, FM, FM & ARM, PWM Capture, and FM Capture blocks use this block in their underlying subsystems. The API for this block is not currently documented.

## DM6814

The DM6814 is a 16-bit counting board with three channels. This board typically connects to incremental encoders. Incremental encoders convert physical motion into electrical pulses that can be used to determine velocity, direction, and distance.

Each board also three I/O ports, with each port containing eight digital I/O lines.

xPC Target supports this board with these driver blocks:

- “DM6814 Incremental Encoder” on page 25-31
- “DM6814 Digital Input” on page 25-31
- “DM6814 Digital Output” on page 25-32

---

**Note** xPC Target does not support the 12 digital input lines on this board.

---

### Board Characteristics

|                                 |                   |
|---------------------------------|-------------------|
| Board name                      | DM6814            |
| Manufacturer                    | Real Time Devices |
| Bus type                        | ISA               |
| Access method                   | I/O mapped        |
| Multiple block instance support | Yes               |
| Multiple board support          | Yes               |



## DM6814 Incremental Encoder

### Scaling Input to Output

| Hardware Output | Block Input Data Type | Scaling |
|-----------------|-----------------------|---------|
| TTL             | Double                | counts  |

### Driver Block Parameters

**Encode Channel** — From the list choose, 1, 2, or 3. This parameter specifies which channel you use for this block. For the same board (same base address) two blocks cannot have the same channel number.

**Counter initial value** — Enter the initial value of the counter. The value must be between 1 and  $2^{16} - 1$ .

**Enable counter reset on px.2 (index input)** — If this check box is selected, the counter is reset to its initial value (default zero) whenever the incremental encoder is moved over its index mark.

For this purpose you must connect the incremental encoder index output to the correct pin: P0.2 for encoder channel 1, P2.2 for channel 2, and P4.2 for channel 3.

**Sample time** — Base sample time or a multiple of the base sample time.

**Base address** — Enter the base address of the board. This entry must correspond to the DIP switch settings on the board. For example, if the base address is 300 (hexadecimal), enter

0x300

### DM6814 Digital Input

You can use only one digital input block per port. You can use an input and an output block for the same port, but then each block must use channels different from those in the other block.

### Scaling Input to Output

| Hardware Input | Block Output Data Type | Scaling                         |
|----------------|------------------------|---------------------------------|
| TTL            | Double                 | TTL low = 0.0<br>TTL high = 1.0 |

### Driver Block Parameters

**Channel Vector** — Enter numbers between 1 and 8 to select the digital input lines used with this port. This driver allows the selection of individual digital input lines in any order. The number of elements defines the number of digital lines used.

For example, to use all the digital inputs for the current port, enter

[ 1,2,3,4,5,6,7,8]

Number the lines beginning with 1 even if the board manufacturer starts numbering the lines with 0.

**Port** — Select port A, B, or C.

**Sample time** — Enter a base sample time or a multiple of the base sample time.

**Base address** — Enter the base address of the board. This entry must correspond to the base address board setting. For example, if the base address is 300 (hexadecimal), enter

0x300

### DM6814 Digital Output

You can configure two digital I/O lines for output. You can use only one digital input block per port. You can use an input and an output block for the same port, but then each block must use channels different from those in the other block.

## Scaling Input to Output

| Hardware Output | Block Input Data Type | Scaling                           |
|-----------------|-----------------------|-----------------------------------|
| TTL             | Double                | <0.5 = TTL low<br>≥0.5 = TTL high |

### Driver Block Parameters

**Channel Vector** — Enter either numbers 1 or 2 to select the digital output lines you use with this port. This driver allows the selection of individual digital output lines in any order. The number of elements defines the number of digital lines used.

For example, to use all available digital outputs for the current port, enter

[1,2]

Number the lines beginning with 1 even if the board manufacturer starts numbering the lines with 0.

**Port** — Select port A, B, or C.

**Reset vector** — The reset vector controls the behavior of the channel at model termination. Enter a scalar or a vector that is the same length as the channel vector. If you specify a scalar value, that setting is used for all channels. If you specify a value of 1, the corresponding channel is reset to the value specified in the initial value vector. If you specify a value of 0, the channel remains at the last value attained while the model was running.

**Initial value vector** — The initial value vector contains the initial values (0 or 1) of the output channels. Enter a scalar or a vector that is the same length as the channel vector. If you enter a scalar, that value is used for all channels. The channels are set to these initial values between the time the model is downloaded and the time it is started.

**Sample time** — Enter a base sample time or a multiple of the base sample time.

**Base address** — Enter the base address of the board. This entry must correspond to the base address board setting. For example, if the base address is 300 (hexadecimal), enter

0x300

## DM6816

The DM6816 is an ISA PC/104 I/O board with 9 independent PWM channels, 8-bit resolution, 3 16-bit timer/counters, and an on-board 8 MHz clock.

xPC Target supports this board with this driver block:

- “DM6816 PWM” on page 25-34

### Board Characteristics

|                                 |                   |
|---------------------------------|-------------------|
| Board name                      | DM6816            |
| Manufacturer                    | Real Time Devices |
| Bus type                        | ISA (PC104)       |
| Access method                   | I/O mapped        |
| Multiple block instance support | No                |
| Multiple board support          | Yes               |

### DM6816 PWM

**Channel vector** — Enter numbers between 1 and 9 to select the PWM channel. This driver allows the selection of individual PWM channels in any order. The number of elements defines the number of channels used.

For example, to use all of the channels, enter

```
[1,2,3,4,5,6,7,8,9]
```

Number the lines beginning with 1 even if the board manufacturer starts numbering the lines with 0.

**Clock source for channels 1, 2, 3** — From the list choose either 8 MHz clock or Timer 1 output as the clock source for the channels. By default, it is Timer 1 output. This parameter affects channels 1, 2, or 3.

**Clock source for channels 4, 5, 6** — From the list choose either 8 MHz clock or Timer 1 output as the clock source for the channels. By default, it is Timer 1 output. This parameter affects channels 4, 5, or 6.

**Clock source for channels 7, 8, 9** — From the list choose either 8 MHz clock or Timer 1 output as the clock source for the channels. By default, it is Timer 1 output. This parameter affects channels 7, 8, or 9.

**Frequency divisors for timers 0, 1, 2** — Enter a vector [d0 d1 d2] of integers, with each integer in the range from 2 to 65535. The driver uses these integers as frequency divisors for the timers 0, 1, and 2, respectively. For example, if timer 0 uses the 8 MHz clock as a source, a frequency divisor value of 4 for d0 causes timer 0 to run at 2 MHz (8 MHz/4).

If you specify one integer in the vector, that value applies to all timers.

**Sample time** — Base sample time or a multiple of the base sample time.

**Base address (e.g. 0xd000)** — Enter the base address of the board. It is important that this entry corresponds to the DIP-switch settings on the board. For example, if the base address is 300 (hexadecimal), enter

0x300

## DM7420

The DM7420 is a PCI PC/104 I/O board with 16 single or 8 differential analog input (A/D) channels (12-bit) with a maximum sample rate of 600 kHz, 8 independent digital I/O lines, 8 dependent digital I/O lines, and 9 counter/timers.

xPC Target supports this board with these driver blocks:

- “DM7420 Analog Input (A/D)” on page 25-36
- “DM7420 Digital Input” on page 25-40
- “DM7420 Digital Output” on page 25-40

---

**Note** xPC Target does not support the counter/timers on this board.

---

### Board Characteristics

|                                 |                   |
|---------------------------------|-------------------|
| Board name                      | DM6604            |
| Manufacturer                    | Real Time Devices |
| Bus type                        | PCI (PC104)       |
| Access method                   | I/O mapped        |
| Multiple block instance support | Yes               |
| Multiple board support          | Yes               |

### DM7420 Analog Input (A/D)

#### Scaling Input to Output

| Hardware Input | Block Output Data Type | Scaling |
|----------------|------------------------|---------|
| volts          | Double                 | 1       |

## Driver Block Parameters

**Channel vector** — Enter numbers between 1 and 16. This driver allows the selection of individual A/D channels in any order. The number of elements defines the number of A/D channels used.

For example, to use the first, second and fifth channels, enter

[ 1,2,5]

Number the channels beginning with 1 even if the board manufacturer starts numbering the channels with 0.

**Range vector** — Enter a range code for each of the channels in the channel vector. The range vector must be the same length as the channel vector. This board allows the range of each channel to be different.

The following table is a list of the ranges for this driver and the corresponding range codes.

| Input Range (V) | Range Code | Input Range (V) | Range Code |
|-----------------|------------|-----------------|------------|
| -10 to +10      | -10        | 0 - 10          | 10         |
| -5 to +5        | -5         |                 |            |

For example, if the first channel is -10 to +10 volts, and the second channel is 0 to 10 volts, enter

[ -10,10]

**Gain vector** — Enter 1, 2, 4, 8, 16, or 32 for each of the channels in the channel vector to choose the gain code of that channel. The gain vector must be the same length as the channel vector. This driver allows the gain of each channel to be different.

The following table is a list of the ranges for this driver given the gain entered in the gain vector.

| <b>Gain</b> | <b>Range (V)</b> |
|-------------|------------------|
| 1           | 0 to 10          |
| 2           | 0 to +5          |
| 4           | 0 to 2.5         |
| 8           | 0 to 1.25        |
| 16          | 0 to 0.625       |
| 32          | 0 to 0.312       |

Notice that by increasing the gain code the voltage range is decreased. The gain divides the input voltage range.

For example, if the first channel has a gain code of 1 (10 volt range) and the second and fifth channels have a gain code of 2 (5 volt range), enter

[1,2,2]

**Input coupling vector** — Enter either 1 (ground-referenced single-ended (RSE)), 2 (nonreferenced singled-ended (NRSE)), or 3 (differential (DIFF)) for each of the channels in the channel vector to choose the coupling code. The coupling vector must be the same length as the channel vector. This driver allows the coupling of each channel to be different.



The following table is a list of the couplings for this driver and the corresponding coupling codes.

| <b>Coupling</b> | <b>Coupling Code</b> | <b>Description</b>                                                                                                                                                                                    |
|-----------------|----------------------|-------------------------------------------------------------------------------------------------------------------------------------------------------------------------------------------------------|
| RSE             | 1                    | High side of input signal connected to the selected analog input channel. Low side of input signal connected to one of the analog ground (ANALOG GND) pins. See the board manual.                     |
| NRSE            | 2                    | High side of input signal connected to the selected analog input channel. Low side of the input signal connected to the analog input sense (AINSENSE) pin at the I/O connector. See the board manual. |
| DIFF            | 3                    | High side of input signal connected to the selected analog input channel AIN1+...AIN8+. Low side of input signal connected to AIN- pin corresponding to the AIN+. See the board manual.               |

For example, if the first and second channels are ground referenced single-ended and the third channel is a differential input, enter

[1,1,3]

For differential inputs, the driver selects a second differential input that is eight channels higher than the first channel. In the example above, the driver selects the eleventh channel (AIN11/AIN3-) as a differential input.

**Sample time** — Base sample time or a multiple of the base sample time.

**PCI Slot (-1:autosearch)** — If only one board of this type is physically present in the target PC, enter

-1

to automatically locate the board.

If two or more boards of this type are physically present in the target PC, enter the bus number and the PCI slot number of the board associated with this driver block. Use the format [BusNumber, SlotNumber]. To determine the bus number and the PCI slot number, type

```
getxpcpci
```

## **DM7420 Digital Input**

**Channel vector** — Enter numbers between 1 and 8 to select the digital input lines used with this port. This driver allows the selection of individual digital input lines in any order. The number of elements defines the number of digital lines used.

For example, to use all of the digital inputs for one port, enter

```
[1,2,3,4,5,6,7,8]
```

Number the lines beginning with 1 even if the board manufacturer starts numbering the lines with 0.

**Port** — From the list choose either 0 or 1.

**Sample time** — Base sample time of a multiple of the base sample time.

**PCI Slot (-1:autosearch)** — If only one board of this type is physically present in the target PC, enter

```
-1
```

to automatically locate the board.

If two or more boards of this type are physically present in the target PC, enter the bus number and the PCI slot number of the board associated with this driver block. Use the format [BusNumber, SlotNumber]. To determine the bus number and the PCI slot number, type

```
getxpcpci
```

## **DM7420 Digital Output**

**Channel vector** — Enter numbers between 1 and 8 to select the digital output lines used with this port. This driver allows the selection of individual digital output lines in any order. The number of elements defines the number of digital lines used.

For example, to use all of the digital outputs for one port, enter

```
[1,2,3,4,5,6,7,8]
```

Number the lines beginning with 1 even if the board manufacturer starts numbering the lines with 0.

**Port** — From the list choose either 0 or 1.

**Sample time** — Base sample time of a multiple of the base sample time.

**PCI Slot (-1:autosearch)** — If only one board of this type is physically present in the target PC, enter

```
-1
```

to automatically locate the board.

If two or more boards of this type are physically present in the target PC, enter the bus number and the PCI slot number of the board associated with this driver block. Use the format [BusNumber, SlotNumber]. To determine the bus number and the PCI slot number, type

```
getxpcpci
```



# SBS Technologies

---

This chapter describes I/O boards supported by xPC Target (<http://www.sbs.com>).

|                                             |                                                                                                        |
|---------------------------------------------|--------------------------------------------------------------------------------------------------------|
| Flex/104A PC/104 IP Carrier Board (p. 26-2) | PC/104 format IP carrier board with a capacity of 2 IP modules.                                        |
| IP-16ADC (p. 26-4)                          | 16 single or 8 differential analog input (A/D) channels (16-bit) with a combined throughput of 100kHz. |
| IP-16DAC (p. 26-6)                          | 3 independent precalibrated analog output (D/A) channels (16-bit).                                     |
| IP-DAC (p. 26-8)                            | 6 independent precalibrated analog output (D/A) channels (12-bit).                                     |
| IP-Digital 24 (p. 26-10)                    | 24 digital I/O lines which can be independently configured for input or output.                        |
| IP-HiADC (p. 26-13)                         | 16 analog input (A/D) channels (12-bit).                                                               |
| IP-Synchro (p. 26-15)                       | Two channels of position measurement using synchro, resolver, LVDT, or Inductosyn® transducers.        |
| IP-Unidig-E-48 (p. 26-17)                   | 48 digital I/O lines which can be independently configured for input or output                         |
| PCI-40A Carrier Board (p. 26-20)            | ISA format IP carrier board with a capacity of 4 IP modules.                                           |
| Broadcast Memory (p. 26-21)                 | PCI broadcast memory node                                                                              |

## Flex/104A PC/104 IP Carrier Board

Each IP module must be physically plugged into an IP carrier board such as the Flex/104A. Models containing IP module blocks must also contain corresponding IP carrier blocks. The relationship ‘IP module A is plugged into carrier B’ is expressed by selecting the same Carrier ID for both A and B.

The Flex/104A holds up to two IP modules.

xPC Target supports this board with this driver blocks:

- “Flex-104A” on page 26-2

### Board Characteristics

|                                 |                                |
|---------------------------------|--------------------------------|
| Board name                      | Flex-104A PC/104 carrier board |
| Manufacturer                    | SBS Technologies               |
| Bus type                        | PC/104                         |
| Access method                   | I/O Mapped                     |
| Multiple block instance support | No                             |
| Multiple board support          | Yes                            |

## Flex-104A

### Driver Block Parameters

**Carrier ID** — Enter a number to uniquely identify this IP carrier board within the model.

**Base address** — Enter the base address of the board. For example, if the base address is 300 (hexadecimal), enter

0x300

This board permutes the expected pinout of the 50-pin I/O connector for each IP module as follows

| <b>Expected Pin</b> | <b>Actual Pin</b> | <b>Expected Pin</b> | <b>Actual Pin</b> | <b>Expected Pin</b> | <b>Actual Pin</b> |
|---------------------|-------------------|---------------------|-------------------|---------------------|-------------------|
| 1                   | 1                 | 18                  | 35                | 35                  | 20                |
| 2                   | 3                 | 19                  | 37                | 36                  | 22                |
| 3                   | 5                 | 20                  | 39                | 37                  | 24                |
| 4                   | 7                 | 21                  | 41                | 38                  | 26                |
| 5                   | 9                 | 22                  | 43                | 39                  | 28                |
| 6                   | 11                | 23                  | 45                | 40                  | 30                |
| 7                   | 13                | 24                  | 47                | 41                  | 32                |
| 8                   | 15                | 25                  | 49                | 42                  | 34                |
| 9                   | 17                | 26                  | 2                 | 43                  | 36                |
| 10                  | 19                | 27                  | 4                 | 44                  | 38                |
| 11                  | 21                | 28                  | 6                 | 45                  | 40                |
| 12                  | 23                | 29                  | 8                 | 46                  | 42                |
| 13                  | 25                | 30                  | 10                | 47                  | 44                |
| 14                  | 27                | 31                  | 12                | 48                  | 46                |
| 15                  | 29                | 32                  | 14                | 49                  | 48                |
| 16                  | 31                | 33                  | 16                | 50                  | 50                |
| 17                  | 33                | 34                  | 18                |                     |                   |

## IP-16ADC

The IP-16ADC I/O board has 16 single or 8 differential analog input (A/D) channels (16-bit) with a combined throughput of 100kHz.

xPC Target supports this board with this driver block:

- “IP-16ADC Analog Input (A/D)” on page 26-4

### Board Characteristics

|                                 |                  |
|---------------------------------|------------------|
| Board name                      | IP-16ADC         |
| Manufacturer                    | SBS Technologies |
| Bus type                        | N/A              |
| Access method                   | I/O Mapped       |
| Multiple block instance support | Yes              |
| Multiple board support          | Yes              |

## IP-16ADC Analog Input (A/D)

### Scaling Input to Output

| Hardware Input | Block Output Data Type | Scaling |
|----------------|------------------------|---------|
| volts          | double                 | 1       |

### Driver Block Parameters

**Carrier ID** — Enter the Carrier ID of the IP carrier board into which the IP module is plugged.

In order to use an IP module, it must be physically plugged into an IP carrier board and the model must contain a block representing this carrier board. Each carrier block has a **Carrier ID** parameter, which must be set to a number not shared by any other carrier board block in the model.



**Carrier slot** — Select the slot on the carrier board into which the IP-16ADC module is plugged. Note that different carrier boards can have different slot capacities.

**Channel vector** — Enter a vector of numbers between 1 and 16. The channel numbers can occur in any order. For example, to use the first and third analog output (A/D) channels, enter

[ 1, 3]

Number the channels beginning with 1 even if the board manufacturer starts numbering the channels with 0.

**Range vector** — Enter a range code for each of the channels in the channel vector. The range vector must be the same length as the channel vector. This board allows the range of each channel to be different.

The following table is a list of the ranges for this driver and the corresponding range codes.

| Range Code | Input Range (V) |
|------------|-----------------|
| -10        | -10 to +10      |
| -5         | -5 to +5        |
| 5          | 0 to 5          |
| 10         | 0 to 10         |

Range codes -10 and -5 specify differential channels, which each use two pins on the I/O cable. Range codes 10 and 5 specify single-ended channels, which each use only one pin. Certain combinations of channel numbers and range codes can refer to conflicting physical I/O pins and will cause an error of the form “Bipolar channel x and unipolar channel y use the same I/O pins”. Consult the section “I/O Pin Wiring” in the IP-16ADC User’s Manual as you select the channel and range vectors to avoid this.

**Sample time** — Enter the base sample time or a multiple of the base sample time.

## IP-16DAC

The IP-16DAC I/O board has 3 independent precalibrated analog output (D/A) channels (16-bit).

xPC Target supports this board with this driver block:

- “IP-16DAC Analog Output (D/A)” on page 26-6

### Board Characteristics

|                                 |                  |
|---------------------------------|------------------|
| Board name                      | IP-16DAC         |
| Manufacturer                    | SBS Technologies |
| Bus type                        | N/A              |
| Access method                   | I/O Mapped       |
| Multiple block instance support | Yes              |
| Multiple board support          | Yes              |

## IP-16DAC Analog Output (D/A)

### Scaling Input to Output

| Hardware Output | Block Input Data Type | Scaling |
|-----------------|-----------------------|---------|
| volts           | double                | 1       |

### Driver Block Parameters

**Carrier ID** — Enter the Carrier ID of the IP carrier board into which the IP module is plugged.

In order to use an IP module, it must be physically plugged into an IP carrier board and the model must contain a block representing this carrier board. Each carrier block has a **Carrier ID** parameter, which must be set to a number not shared by any other carrier board block in the model.

**Carrier slot** — Select the slot on the carrier board into which the IP-16DAC module is plugged. Note that different carrier boards can have different slot capacities.

**Channel vector** — Enter a vector of numbers between 1 and 3. The channel numbers can occur in any order. For example, to use the first and second analog output (D/A) channels, enter

[ 1,2]

Channel numbers 1, 2, and 3 correspond to DAC A, DAC B, and DAC C respectively.

**Range vector** — Enter a range code for each of the channels in the channel vector. The range vector must be the same length as the channel vector. This board allows the range of each channel to be different.

The following table is a list of the ranges for this driver and the corresponding range codes.

| Range Code | Input Range (V) |
|------------|-----------------|
| -10        | -10 to +10      |
| -5         | -5 to +5        |
| 5          | 0 to 5          |
| 10         | 0 to 10         |

For example, if the first channel is -10 to +10 volts, and the second channel is 0 to 5 volts, enter [-10,5]

The range settings must correspond to the jumper settings on the board for DAC A and DAC B and DAC C.

**Sample time** — Base sample time of a multiple of the base sample time.

## IP-DAC

The IP-DAC I/O board has 6 independent precalibrated analog output (D/A) channels (12-bit).

xPC Target supports this board with this driver blocks:

- “IP-DAC Analog Output (D/A)” on page 26-8

### Board Characteristics

|                                 |                  |
|---------------------------------|------------------|
| Board name                      | IP-DAC           |
| Manufacturer                    | SBS Technologies |
| Bus type                        | N/A              |
| Access method                   | I/O Mapped       |
| Multiple block instance support | Yes              |
| Multiple board support          | Yes              |

### IP-DAC Analog Output (D/A)

#### Scaling Input to Output

| Hardware Output | Block Input Data Type | Scaling |
|-----------------|-----------------------|---------|
| volts           | double                | 1       |

### Driver Block Parameters

**Carrier ID** — Enter the Carrier ID of the IP carrier board into which the IP module is plugged.

In order to use an IP module, it must be physically plugged into an IP carrier board and the model must contain a block representing this carrier board. Each carrier block has a **Carrier ID** parameter, which must be set to a number not shared by any other carrier board block in the model.

**Carrier slot** — Select the slot on the carrier board into which the IP-16ADC module is plugged. Note that different carrier boards can have different slot capacities.

**Channel vector** — Enter a vector of numbers between 1 and 6. The channel numbers can occur in any order. For example, to use the first and second analog output (D/A) channels, enter

[ 1,2]

Number the channels beginning with 1 even if the board manufacturer starts numbering the channels with 0.

**Range vector** — Enter a range code for each of the channels in the channel vector. The range vector must be the same length as the channel vector. This board allows the range of each channel to be different.

The following table is a list of the ranges for this driver and the corresponding range codes.

| Range Code | Input Range (V) |
|------------|-----------------|
| -10        | -10 to +10      |
| -5         | -5 to +5        |
| -2.5       | -2.5 to 2.5     |
| 5          | 0 to 5          |
| 10         | 0 to 10         |

For example, if the first channel is -10 to +10 volts, and the second channel is 0 to 5 volts, enter [-10,5]

The range settings have to correspond to the OUTPUT RANGE SELECTION settings on the board for DAC0 and DAC1 (channel 1 and 2 respectively).

**Sample time** — Base sample time of a multiple of the base sample time.

## IP-Digital 24

IP-Digital 24 boards have 24 digital I/O lines which can be independently configured for input or output.

xPC Target supports this board with these driver blocks:

- “IP-Digital 24 Digital Input” on page 26-10
- “IP-Digital 24 Digital Output” on page 26-11

### Board Characteristics

|                                 |                  |
|---------------------------------|------------------|
| Board name                      | IP-Digital-24    |
| Manufacturer                    | SBS Technologies |
| Bus type                        | N/A              |
| Access method                   | I/O Mapped       |
| Multiple block instance support | Yes              |
| Multiple board support          | Yes              |

## IP-Digital 24 Digital Input

### Scaling Input to Output

| Hardware Input | Block Output Data Type | Scaling                         |
|----------------|------------------------|---------------------------------|
| TTL            | double                 | TTL low = 0.0<br>TTL high = 1.0 |

## Driver Block Parameters

**Carrier ID** — Enter the Carrier ID of the IP carrier board into which the IP module is plugged.

In order to use an IP module, it must be physically plugged into an IP carrier board and the model must contain a block representing this carrier board. Each carrier block has a **Carrier ID** parameter, which must be set to a number not shared by any other carrier board block in the model.

**Carrier slot** — Select the slot on the carrier board into which the IP-Digital 24 module is plugged. Note that different carrier boards can have different slot capacities.

**Channel vector** — Enter numbers between 1 and 24 to select the digital input lines to be used. This driver allows the selection of individual digital input lines in any order. The number of elements defines the number of lines used.

For example, to use the first three digital inputs, enter

[1,2,3]

Number the lines beginning with 1 even if the board manufacturer starts numbering the lines with 0.

**Sample time** — Enter a base sample time or a multiple of the base sample time.

## IP-Digital 24 Digital Output

### Scaling Input to Output

| Hardware Input | Block Output Data Type | Scaling                         |
|----------------|------------------------|---------------------------------|
| TTL            | double                 | TTL low = 0.0<br>TTL high = 1.0 |

### **Driver Block Parameters**

**Carrier ID** — Enter the Carrier ID of the IP carrier board into which the IP module is plugged.

In order to use an IP module, it must be physically plugged into an IP carrier board and the model must contain a block representing this carrier board. Each carrier block has a **Carrier ID** parameter, which must be set to a number not shared by any other carrier board block in the model.

**Channel vector** — Enter numbers between 1 and 24 to select the digital output lines to be used. This driver allows the selection of individual digital output lines in any order. The number of elements defines the number of lines used.

For example, to use the first three digital outputs, enter

[1,2,3]

Number the lines beginning with 1 even if the board manufacturer starts numbering the lines with 0.

**Sample time** — Enter a base sample time or a multiple of the base sample time.



## IP-HiADC

The IP-HiADC I/O board has 16 analog input (A/D) channels (12-bit).  
xPC Target supports this board with this driver block:

- “IP-HiADC Analog Input (A/D)” on page 26-13

### Board Characteristics

|                                 |                  |
|---------------------------------|------------------|
| Board name                      | IP-HiADC         |
| Manufacturer                    | SBS Technologies |
| Bus type                        | N/A              |
| Access method                   | I/O Mapped       |
| Multiple block instance support | Yes              |
| Multiple board support          | Yes              |

### IP-HiADC Analog Input (A/D)

#### Scaling Input to Output

| Hardware Input | Block Output Data Type | Scaling |
|----------------|------------------------|---------|
| volts          | double                 | 1       |

#### Driver Block Parameters

**Carrier ID** — Enter the Carrier ID of the IP carrier board into which the IP module is plugged.

In order to use an IP module, it must be physically plugged into an IP carrier board and the model must contain a block representing this carrier board. Each carrier block has a **Carrier ID** parameter, which must be set to a number not shared by any other carrier board block in the model.

**Carrier slot** — Select the slot on the carrier board into which the IP-HiADC module is plugged. Note that different carrier boards can have different slot capacities.

**Channel vector** — Enter a vector of numbers between 1 and 16. The channel numbers can occur in any order. For example, to use the first and third analog output (A/D) channels, enter

[1, 3]

Number the channels beginning with 1 even if the board manufacturer starts numbering the channels with 0.

**Range** — Select either -5V to 5V or -10V to 10V. This applies to all channels.

**Sample time** — Enter the base sample time or a multiple of the base sample time.

## IP-Synchro

IP-Synchro provides two channels of position measurement using synchro, resolver, LVDT, or Inductosyn® transducers.

xPC Target supports this board with this driver block:

- “IP-Synchro” on page 26-15

### Board Characteristics

|                                 |                  |
|---------------------------------|------------------|
| Board name                      | IP-Synchro       |
| Manufacturer                    | SBS Technologies |
| Bus type                        | N/A              |
| Access method                   | I/O Mapped       |
| Multiple block instance support | No               |
| Multiple board support          | Yes              |

## IP-Synchro

### Scaling Input to Output

| Hardware Output     | Block Output Data Type | Scaling          |
|---------------------|------------------------|------------------|
| Synchro or Resolver | double                 | angle in radians |

### Driver Block Parameters

**Carrier ID** — Enter the Carrier ID of the IP carrier board into which the IP-Synchro module is plugged.

In order to use an IP module, it must be physically plugged into an IP carrier board and the model must contain a block representing this carrier board. Each carrier block has a **Carrier ID** parameter, which must be set to a number not shared by any other carrier board block in the model.

**Carrier slot** — Select the slot on the carrier board into which the IP-Synchro module is plugged. Note that different carrier boards can have different slot capacities.

**Channel vector** — Enter a vector with one or two elements to select the Synchro/Resolver input channels you use with this block. 1 represents channel A and 2 represents channel B. This driver allows the selection of inputs in either order.

For example to use channels A and B in that order, enter

[1,2]

**Precision vector** — This must be a scalar or a vector the same length as the channel vector. For each input channel it specifies a precision of either 10, 12, 14, or 16 bits. If the automatic precision option is in effect, then the selected precision for each channel will be used for the entire run. Otherwise it merely specifies the initial precision.

**Automatic precision** — Select this check box to have the IP-Synchro automatically change its precision (resolution) in order to track the input velocity.

**Output format** — This option selects the output status format.

- position — Output position only
- position and status — Output position and status

**Sample time** — Enter a base sample time or a multiple of the base sample time.

## IP-Unidig-E-48

IP-Unidig-E-48 boards have 48 digital I/O lines which can be independently configured for input or output.

xPC Target supports this board with these driver blocks:

- “IP-Unidig-E-48 Digital Input” on page 26-17
- “IP-Unidig-E-48 Digital Output” on page 26-18

### Board Characteristics

|                                 |                  |
|---------------------------------|------------------|
| Board name                      | IP-Unidig-E-48   |
| Manufacturer                    | SBS Technologies |
| Bus type                        | N/A              |
| Access method                   | I/O Mapped       |
| Multiple block instance support | Yes              |
| Multiple board support          | Yes              |

## IP-Unidig-E-48 Digital Input

### Scaling Input to Output

| Hardware Input | Block Output Data Type | Scaling                         |
|----------------|------------------------|---------------------------------|
| TTL            | double                 | TTL low = 0.0<br>TTL high = 1.0 |

**Driver Block Parameters**

**Carrier ID** — Enter the Carrier ID of the IP carrier board into which the IP module is plugged.

In order to use an IP module, it must be physically plugged into an IP carrier board and the model must contain a block representing this carrier board. Each carrier block has a **Carrier ID** parameter, which must be set to a number not shared by any other carrier board block in the model.

**Carrier slot** — Select the slot on the carrier board into which the IP-Unidig-E-48 module is plugged. Note that different carrier boards can have different slot capacities.

**Channel vector** — Enter numbers between 1 and 48 to select the digital input lines to be used. This driver allows the selection of individual digital input lines in any order. The number of elements defines the number of lines used.

For example, to use the first three digital inputs, enter

[ 1,2,3]

Number the lines beginning with 1 even if the board manufacturer starts numbering the lines with 0.

**Sample time** — Enter a base sample time or a multiple of the base sample time.

**IP-Unidig-E-48 Digital Output**

**Scaling Input to Output**

| Hardware Input | Block Output Data Type | Scaling                         |
|----------------|------------------------|---------------------------------|
| TTL            | double                 | TTL low = 0.0<br>TTL high = 1.0 |

### Driver Block Parameters

**Carrier ID** — Enter the Carrier ID of the IP carrier board into which the IP module is plugged.

In order to use an IP module, it must be physically plugged into an IP carrier board and the model must contain a block representing this carrier board. Each carrier block has a **Carrier ID** parameter, which must be set to a number not shared by any other carrier board block in the model.

**Channel vector** — Enter numbers between 1 and 48 to select the digital output lines to be used. This driver allows the selection of individual digital output lines in any order. The number of elements defines the number of lines used.

For example, to use the first three digital outputs, enter

[1,2,3]

Number the lines beginning with 1 even if the board manufacturer starts numbering the lines with 0.

**Sample time** — Enter a base sample time or a multiple of the base sample time.

## PCI-40A Carrier Board

Each IP module must be physically plugged into an IP carrier board such as the PCI-40A. Models containing IP module blocks must also contain corresponding IP carrier blocks. The relationship 'IP module A is plugged into carrier B' is expressed by selecting the same Carrier ID for both A and B. The PCI-40A holds up to four IP modules. xPC Target supports this board with this driver block:

- "PCI-40A" on page 26-20

### Board Characteristics

|                                 |                       |
|---------------------------------|-----------------------|
| Board name                      | PCI-40A carrier board |
| Manufacturer                    | SBS Technologies      |
| Bus type                        | PCI                   |
| Access method                   | I/O Mapped            |
| Multiple block instance support | No                    |
| Multiple board support          | Yes                   |

## PCI-40A

### Driver Block Parameters

**Carrier ID** — Enter a number to uniquely identify this IP carrier board within the model.

**PCI Slot (-1:autosearch)** — If only one board of this type is physically present in the target PC, enter

-1

to automatically locate the board.

If two or more boards of this type are physically present in the target PC, enter the bus number and the PCI slot number of the board associated with this driver block. Use the format [BusNumber, SlotNumber]. To determine the bus number and the PCI slot number, type

```
getxpcpci
```



## Broadcast Memory

xPC Target uses a model for shared memory that includes Simulink blocks, for the shared memory drivers, and MATLAB structures for defining shared memory and node initialization partitions. The topics in this section are

- “Create Shared Memory Partitions” on page 26-21 — Before you begin to use SBS Broadcast Memory shared memory blocks, define a partition structure that defines how you want to allocate shared memory.
- “Initialize Shared Memory Nodes” on page 26-24 — Before you begin to use SBS Broadcast Memory shared memory blocks, define a node initialization structure that defines how shared memory is allocated (partitioned) and how the board is configured.

---

**Note** The xPC Target SBS25x0 driver does not fully support node-to-node network configuration. In most cases, a shared memory hub is required to use the SBS Shared driver blocks. If you have additional questions, please contact The MathWorks Technical Support.

---

### Create Shared Memory Partitions

To use the xPC Target SBS Broadcast Memory shared memory blocks to read, write, pack, or unpack data, you must define a partition structure. SBS Broadcast Memory shared memory drivers use MATLAB structures to define shared memory partitions. A partition structure describes how you want to allocate (or partition) the shared memory. xPC Target allocates shared memory with bundles of data that are packed into memory partitions. The following SBS Broadcast Memory blocks use shared memory partition structures:

- Shared memory read/write
- Shared memory pack/unpack

After you define the shared memory partitions, you can add SBS Broadcast Memory shared memory driver blocks to your Simulink model. Create a shared memory structure in one of the following ways. See “Shared Memory Partition Structure” on page 26-29 for the complete list of fields for the structure.

The following description refers to the `smpart sbs25x0` command. Type

```
help smpartsbs25x0
```

for a description of the command.

- Using the `smpartsbs25x0` command at the MATLAB Command Window, create a default partition structure. For example, type

```
x=smpartsbs25x0
```

```
>> smpartsbs25x0
SBS25x0 Shared Memory Partition
Shared-Memory partition
  Total Bytes in partition = 4
  Starting Address = 0x0
  Number of segments = 1
```

To get the contents of `x`, type

```
>> get(x)
```

```
ans =
      Address: '0x0'
      Type: 'uint32'
  Alignment: '4'
      Size: '[ 1 ]'
      WIT: 'off'
```

- At the MATLAB Command Window, create a user-defined partition structure. The easiest way to do this is to create an M-file, partially define a structure, load that M-file into the MATLAB workspace. For example

```
Partition(1).Address='0x5000';
Partition(1).Type='int8';
Partition(1).Size='10';
Partition(2).Type='uint16';
Partition(2).Size='5';
Partition(3).Type='uint8';
Partition(3).Size='1';
Partition(3).Alignment='8';
Partition(4).Type='double';
Partition(4).Size='3';
```

To get the contents of `x` with these settings, type

```
>> x=smpartsbs25x0(Partition)

SBS25x0 Shared Memory Partition
Shared-Memory partition
  Total Bytes in partition = 16
  Starting Address = 0x5000
  Number of segments = 4
```

This example defines a partition with four segments.

- The Address field is optional. Only specify this field for the first segment of a partition. The elements of a partition are defined as a continuous memory block from the first address. The following segments extrapolate their addresses from the first segment. If you have fragmented memory, use multiple partitions and SBS Broadcast Memory read/write blocks to work with the memory.
- The Type and Size fields are required for all fields in the partition structure.
- The Alignment value is optional. It is '4' by default, which forces segments that do not have alignment specifications to start on 4 byte (32 bit) boundaries. In this partition, the third segment (Partition(3)) has an alignment of '8'.
- The base addresses of subsequent segments are fully defined by the data type, size, and alignment of the preceding segment.
- You can then call the `smpartsbs25x0()` command to fully populate the partition structure.

## Initialize Shared Memory Nodes

To use the xPC Target SBS Broadcast Memory shared memory, you must define a node initialization structure. SBS Broadcast Memory shared memory drivers use MATLAB structures to define shared memory node initialization. A node initialization structure describes the shared memory partition (see “Create Shared Memory Partitions” on page 26-21) and the SBS Broadcast Memory board configuration, including interrupt configurations. The following SBS Broadcast Memory block requires shared memory node initialization structures:

- SBS25x0 init

After you define the node initialization partition, you can add SBS Broadcast Memory shared memory driver blocks to your Simulink model. Create a shared memory structure in one of the following ways. See “Shared Memory Node Initialization Structure” on page 26-31 for the complete list of fields for the structure.

The following description refers to the `smnodesbs25x0` command. Type

```
help smnodesbs25x0
```

for a description of the command.

Using the `smnodesbs25x0` command at the MATLAB Command Window, create a default node initialization structure. For example, type

```
>> node=smnodesbs25x0
Node Definition for SBS2500/SBS2510 Broadcast Memory
```

To get the contents of node, type

```
>> get(node)

ans =
    TargetAbortEnable: 'off'
    LoopbackEnable: 'off'
    Node2Node: 'off'
    RXEnable: 'on'
    TXEnable: 'on'
    MemorySize: '256kByte'
    WITEnable: 'off'
    IRQ_ErrorEnable: 'off'
```

```

    IRQ_WITEnable: 'off'
    Partition: []
    SlotID: 'any'

```

- At the MATLAB Command Window, create a user-defined node structure. The easiest way to do this is to create an M-file, partially define a structure, load that M-file into the MATLAB workspace. For example

```

z.LoopbackEnable='on';
z.Partition=x

```

To get the contents of node with these settings, type

```
>> node=smnodesbs25x0(node1)
```

```

Node Definition for SBS2500/SBS2510 Broadcast Memory
>> get(node)

```

```

ans =
    TargetAbortEnable: 'off'
    LoopbackEnable: 'on'
    Node2Node: 'off'
    RXEnable: 'on'
    TXEnable: 'on'
    MemorySize: '256kByte'
    WITEnable: 'off'
    IRQ_ErrorEnable: 'off'
    IRQ_WITEnable: 'off'
    Partition: [1x1 smpartsbs25x0]
    SlotID: 'any'

```

Currently, you can define values only for the fields **LoopbackEnable**, **WITEnable**, and **Partition**.

## SBS 2510/2500 Broadcast Memory

The SBS 2510/2500 Broadcast Memory board is a high-speed fiber optic reflective memory. It can also generate/broadcast interrupts. xPC Target uses this board as part of the shared memory network that you can use to exchange data between computer nodes.

xPC Target supports this board with these driver blocks:

- “SBS25x0 init” on page 26-26
- “SBS25x0 read” on page 26-27
- “SBS25x0 write” on page 26-28
- “Shared Memory Pack” on page 26-28
- “Shared Memory Unpack” on page 26-29

For information about the Change endianness block, see “Byte Reversal/Change Endianness Block” in Chapter 6.

### **Board Characteristics**

|                                 |                      |
|---------------------------------|----------------------|
| Board name                      | SBS Broadcast Memory |
| Manufacturer                    | SBS                  |
| Bus type                        | PCI                  |
| Access method                   | Memory mapped        |
| Multiple block instance support | Yes                  |
| Multiple board support          | Yes                  |

### **SBS25x0 init**

#### **Driver Block Parameters**

Before you begin to configure these block parameters, be sure that you have a predefined node initialization structure. See “Initialize Shared Memory Nodes” on page 26-24.

Each model that uses shared memory must have one 5565 init block for every SBS Broadcast Memory board in the system.

**Node struct** — Enter the name of the predefined node initialization structure.

**PCI Slot (-1:autosearch)** — If only one board of this type is physically present in the target PC, enter

- 1

to automatically locate the board.

If two or more boards of this type are physically present in the target PC, enter the bus number and the PCI slot number of the board associated with this driver block. Use the format [BusNumber, SlotNumber]. To determine the bus number and the PCI slot number, type

```
getxpcpci
```

## SBS25x0 read

### Driver Block Parameters

Before you begin to configure this block, be sure that you have a predefined shared memory partition structure. The 5565 read block requires this structure to specify how Simulink signal values are mapped in the shared memory. It also uses this structure to determine the total size and address of the shared memory. See “Create Shared Memory Partitions” on page 26-21.

**Partition struct** — Enter the name of the predefined shared memory partition structure. The block uses this structure to specify how Simulink signal values map into shared memory.

**Sampletime** — Enter the base sample time or a multiple of the base sample time.

**PCI Slot (-1:autosearch)** — If only one board of this type is physically present in the target PC, enter

```
-1
```

to automatically locate the board.

If two or more boards of this type are physically present in the target PC, enter the bus number and the PCI slot number of the board associated with this driver block. Use the format [BusNumber, SlotNumber]. To determine the bus number and the PCI slot number, type

```
getxpcpci
```

**Error Status Port** — Select this check box to monitor the status of the SBS Broadcast Memory board LIER register modes.

## SBS25x0 write

### Driver Block Parameters

Before you begin to configure this block, be sure that you have a predefined shared memory partition structure. The 5565 write block requires this structure to specify how Simulink signal values are mapped in the shared memory. It also uses this structure to determine the total size and address of the shared memory. See “Create Shared Memory Partitions” on page 26-21.

**Partition struct** — Enter the name of the predefined shared memory partition and object. The block uses this structure to specify how Simulink signal values map into shared memory.

**Sampletime** — Enter the base sample time or a multiple of the base sample time.

**PCI Slot (-1:autosearch)** — If only one board of this type is physically present in the target PC, enter

-1

to automatically locate the board.

If two or more boards of this type are physically present in the target PC, enter the bus number and the PCI slot number of the board associated with this driver block. Use the format [BusNumber, SlotNumber]. To determine the bus number and the PCI slot number, type

```
getxpcpci
```

**Error Status Port** — Select this check box to monitor the status of the SBS Broadcast Memory board LIER register modes.

### Shared Memory Pack

Before you begin to configure this block, be sure that you have a predefined shared memory partition structure.

Memory partitions consist of groups of Simulink signals, which are combined into blocks (packets) of 32 bit words. The 5565 pack block packs the specified partition structure into an unstructured double word array vector by converting one or more Simulink signals of varying data types into the vector. Typically, the input to a pack block is the output from a write block. Simulink



is not aware of structures; you must pass the output of each structure segment as input to the 5565 pack block.

This block ignores the **Address** field of the partition structure.

### Driver Block Parameters

**Partition struct** — Enter the name of the predefined shared memory partition structure.

## Shared Memory Unpack

Before you begin to configure this block, be sure that you have a predefined shared memory partition structure.

The 5565 unpack block unpacks an unstructured double word array vector (from the 5565 pack block) into the specified partition structure. This block ignores the **Address** field of the partition structure.

### Driver Block Parameters

**Partition struct** — Enter the name of the predefined shared memory partition structure. The block unpacks the double word array vector into this structure.

## Shared Memory Structure Reference

You do not need to use all the fields of a partition or node initialization structure. However, knowing the possible structure fields will be helpful when you are creating any of the structures.

This section includes the following topics:

- “Shared Memory Partition Structure” on page 26-29 — Description of the partition node structure fields
- “Shared Memory Node Initialization Structure” on page 26-31 — Description of the node initialization structure fields

### Shared Memory Partition Structure

A shared memory partition structure has the following fields:

```
Address: '0x0'  
      Type: 'uint32'  
Alignment: '4'
```

Size: '[ 1 ]'  
WIT: 'off'

where:

| <b>Partition Fields</b> | <b>Description</b>                                                                                                                                                                                                                                                                                                                                                                                                                                                     |
|-------------------------|------------------------------------------------------------------------------------------------------------------------------------------------------------------------------------------------------------------------------------------------------------------------------------------------------------------------------------------------------------------------------------------------------------------------------------------------------------------------|
| <b>Address</b>          | <p>Specifies the base address (in hexadecimal) of the memory partition within the node's shared memory space. The default value is '0x0', the first location in shared memory.</p> <p>Align partition addresses on 32-bit word boundaries (for example, 0x0, 0x4, 0x8, and so forth).</p>                                                                                                                                                                              |
| <b>Type</b>             | <p>Specifies the data type of the memory segment. Specify one of the following types:</p> <ul style="list-style-type: none"> <li>• single (IEEE Single Precision)</li> <li>• double (IEEE Double Precision)</li> <li>• uint8</li> <li>• int8</li> <li>• uint16</li> <li>• int16</li> <li>• uint32</li> <li>• int32</li> <li>• Boolean (a single byte represents a boolean value)</li> </ul> <p>The default value is 'uint32'. A minimum partition size is 32 bits.</p> |

| <b>Partition Fields</b> | <b>Description</b>                                                                                                                                                                                                                                                                                                                                                                                                                                                                                                                                                                                                                                                                                                        |
|-------------------------|---------------------------------------------------------------------------------------------------------------------------------------------------------------------------------------------------------------------------------------------------------------------------------------------------------------------------------------------------------------------------------------------------------------------------------------------------------------------------------------------------------------------------------------------------------------------------------------------------------------------------------------------------------------------------------------------------------------------------|
| <b>Size</b>             | <p>Specifies the dimension and size of the memory segment. You can enter a scalar value or a value with the <code>[m, n]</code> format. The default value is <code>'1'</code>.</p> <ul style="list-style-type: none"> <li>• scalar — Treats the Size entry as the specification of the length of a non-oriented array or vector</li> <li>• <code>[m, n]</code> — Treats the Size entry as an array dimension. The total number of elements in this segment is <math>m*n</math>.</li> </ul>                                                                                                                                                                                                                                |
| <b>Alignment</b>        | <p>If another partition precedes this partition, defines the byte alignment of this segment. Specify one of the following alignment values: 1, 2, 3, 4, or 8. The default value is <code>'4'</code>. This value forces a double word boundary alignment for the first address of this segment.</p>                                                                                                                                                                                                                                                                                                                                                                                                                        |
| <b>WIT</b>              | <p>Write Interrupt Table. If this partition segment receives a write request, specifies whether or not the partition generates an interrupt. Specify <code>'off'</code>, <code>'first'</code>, <code>'all'</code>, <code>'last'</code>. The default value is <code>'off'</code>.</p> <p><code>'off'</code> — Prevents the partition from generating interrupts</p> <p><code>'first'</code> — Allows a write to the first double word of the memory block to generate an interrupt.</p> <p><code>'all'</code> — Allows a write to all locations of the memory block to generate an interrupt.</p> <p><code>'last'</code> — Allows a write to only the last double word of the memory segment to generate an interrupt.</p> |

### Shared Memory Node Initialization Structure

A node initialization structure has the following fields:

```

TargetAbortEnable: 'off'
  LoopbackEnable: 'off'
    Node2Node: 'off'
      RXEnable: 'on'

```

```

        TXEnable: 'on'
        MemorySize: '256kByte'
        WITEnable: 'off'
    IRQ_ErrorEnable: 'off'
    IRQ_WITEnable: 'off'
        Partition: []
        SlotID: 'any'
    
```

These values affect the Extended Control Register. Refer to the SBS Broadcast Memory product documentation for further details on registers.

Of particular note are the following register modes:

| <b>Board Modes</b>     | <b>Description</b>                                                                                                                                                                                                                                                                                                                                                      |
|------------------------|-------------------------------------------------------------------------------------------------------------------------------------------------------------------------------------------------------------------------------------------------------------------------------------------------------------------------------------------------------------------------|
| <b>Loopback Enable</b> | Specifies if xPC Target can operate without having the shared memory network fully operational. <ul style="list-style-type: none"> <li>• 'off' — Normal shared memory operation (requires operating shared memory network)</li> <li>• 'on' — Loop back enable. This allows xPC Target to operate without having the shared memory network fully operational.</li> </ul> |

| <b>Board Modes</b> | <b>Description</b>                                                                                                                                                                                                                                                                                                                                                                                                                                                                                                        |
|--------------------|---------------------------------------------------------------------------------------------------------------------------------------------------------------------------------------------------------------------------------------------------------------------------------------------------------------------------------------------------------------------------------------------------------------------------------------------------------------------------------------------------------------------------|
| <b>Memory Size</b> | <p>Specifies the minimum memory size required. The SBS Broadcast Memory driver checks this value against the memory size of the SBS Broadcast Memory board. An SBS Broadcast Memory board has a memory size of either '64MByte' or '128MByte'. If you enter a size in this field that is larger than the actual SBS Broadcast Memory board memory size, the driver will return an error. You can enter values of:</p> <p>'256kByte'</p> <p>'512kByte'</p> <p>'1MByte'</p> <p>'2MByte'</p> <p>'4MByte'</p> <p>'8MByte'</p> |
| <b>Partition</b>   | <p>Specifies the memory partition to be initialized. The node requires this value to initialize the interrupt table for the partition. This parameter is required for xPC Target configurations that will be driven by shared memory interrupts.</p>                                                                                                                                                                                                                                                                      |

**Board Interrupts.** If you want to have an interrupt source, the SBS shared memory board can generate PCI interrupts in response to writes to memory partitions of a memory block. You define this behavior through the **WIT** field of shared memory partition structure. Each partition segment has its own **WIT** setting.

To enable a memory location to generate an interrupt, set the **WIT** field as desired, then configure the xPC Target model to generate an interrupt.

The following procedure describes how to configure an entire xPC Target model to accept an interrupt from an SBS shared memory board:

- 1** From the MATLAB Command Window, type  
`getxpcpci`

This command lists board information for all installed PCI devices that xPC Target knows about.

- 2** If you have multiple SBS shared memory boards, find the board ID for which you want to define the interrupt.
- 3** Find the IRQ specified for your SBS25x0 board.

This is the interrupt source number you need to specify in the **xPC target code generation options** field in step 10 of the following procedure.

- 4** From the MATLAB Command Window, type the name of your Simulink model.

The Simulink model appears.

- 5** From the **Simulation** menu, click **Simulation Parameters**.

- 6** Click the **Real-Time Workshop** tab.

- 7** From the Category list, choose **xPC Target code generation options**.

- 8** Ensure that the **Execution mode** field is set to Real-Time.

- 9** Click the **Real-Time interrupt source** list.

- 10** Select the interrupt number to which the board is set (from step 3).

- 11** Click the **I/O board generating the interrupt** list and select the SBS board that is associated with the IRQ. From the list, choose the appropriate board ID:

SBS\_25x0\_ID\_0x100  
SBS\_25x0\_ID\_0x101  
SBS\_25x0\_ID\_0x102  
SBS\_25x0\_ID\_0x103

**12** If your system has multiple boards, at the **PCI slot/ISA base address** parameter, specify the PCI slot that contains the board you are configuring for interrupts.

**13** Click **OK**.





# Sensoray

---

This chapter describes the Sensoray boards supported by xPC Target (<http://www.sensoray.com>).

526 (p. 27-2)

Multifunction measurement and control board with eight 16-bit analog inputs, four 16-bit analog outputs, four 24-bit quadrature encoder inputs, and eight digital I/O channels.

626 (p. 27-11)

Multifunction I/O board with 16 14-bit differential analog inputs, four 13-bit analog outputs, three pairs of 24-bit up/down counters (total of six counters), 48 digital I/O channels, watchdog timer, and backup battery support.

## 526

The Sensoray 526 is a multifunction measurement and control board. It has eight 16-bit analog inputs, four 16-bit analog outputs, four 24-bit quadrature encoder inputs, and eight digital I/O channels.

xPC Target supports this board with these driver blocks:

- “Sensoray526 AD” on page 27-2
- “Sensoray526 Dual AD” on page 27-3
- “Sensoray526 DA” on page 27-4
- “Sensoray526 Dual DA” on page 27-5
- “Sensoray526 DI” on page 27-7
- “Sensoray526 DO” on page 27-8
- “Sensoray526 Encoder Input” on page 27-9

### Board Characteristics

|                                 |            |
|---------------------------------|------------|
| Board name                      | 526        |
| Manufacturer                    | Sensoray   |
| Bus type                        | PC/104     |
| Access method                   | I/O mapped |
| Multiple block instance support | No         |
| Multiple board support          | Yes        |

### Sensoray526 AD

#### Scaling of Input to Output

| Hardware Input   | Block Output Data Type | Scaling |
|------------------|------------------------|---------|
| volts [-10, +10] | Double [-10,+10]       | 1       |

### Driver Block Parameters

**Channels** — Enter a vector of numbers between 1 and 8. Do not repeat any channel number. For example, to use the first, second and fifth channels, enter

[1, 2, 5]

Number the channels beginning with 1 even though the board manufacturer numbers them beginning with 0.

**Sample time** — Base sample time or a multiple of the base sample time.

**Base address** — Enter the base address of the board. This entry must correspond to the base address DIP switch settings on the board. For example, if the base address is 2C0 (hexadecimal), enter

0x2C0

Note that the Sensoray 526 board ships from the manufacturer with a base address of 0x2C0. If you want to change the base address, see the board manufacturer documentation for allowed values.

## Sensoray526 Dual AD

The Sensoray526 Dual AD block controls two boards simultaneously. This enables simultaneous conversion for both boards. Each board does not have to wait for the other to finish converting data before starting its own conversion. Acquisition overlaps result in considerable time savings.

### Scaling of Input to Output

| Hardware Input  | Block Output Data Type | Scaling |
|-----------------|------------------------|---------|
| volts [-10,+10] | Double [-10,+10]       | 1       |

### Driver Block Parameters

**Board A Channels/Board B Channels** — For each board, enter a vector of numbers between 1 and 8. Do not repeat any channel number. For example, to use the first, second and fifth channels, enter

[1, 2, 5]

Note, for optimal performance, equally split the active channels between the two boards. If you need eight channels, use four channels on each board.

Number the channels beginning with 1 even though the board manufacturer numbers them beginning with 0.

**Sample time** — Base sample time or a multiple of the base sample time.

**Board A base address/Board B base address** — Enter the base address of the board. This entry must correspond to the base address DIP switch settings on the board. For example, if the base address is 2C0 (hexadecimal), enter

0x2C0

Note that the Sensoray 526 board ships from the manufacturer with a base address of 0x2C0. If you want to change the base address, see the board manufacturer documentation for allowed values. For dual boards, change the base address of at least one of the boards. The boards cannot have the same base address.

## Sensoray526 DA

### Scaling of Input to Output

| Hardware Output | Block Input Data Type | Scaling |
|-----------------|-----------------------|---------|
| volts [10, +10] | Double [10, +10]      | 1       |

### Driver Block Parameters

**Channels** — Enter a vector of numbers between 1 and 4. Do not repeat any channel number. For example, to use the first, second and fourth channels, enter

[1, 2, 4]

Number the channels beginning with 1 even though the board manufacturer numbers them beginning with 0.

**Reset vector** — The reset vector controls the behavior of the channel at model termination. Enter a scalar or a vector that is the same length as the channel vector. If you specify a scalar value, that setting is used for all channels. If you specify a value of 1, the corresponding channel is reset to the value specified in the initial value vector. If you specify a value of 0, the channel remains at the last value attained while the model was running.

**Initial value vector** — The initial value vector contains the initial voltage values for the output channels. At initialization, the block always uses this value. If **Reset vector** has a value of 1, the board sets the corresponding channel to the value of the **Initial value vector** when execution stops. Enter a double precision voltage value in the range -10 to +10. This must be scalar or a vector that is the same length as the channel vector. If you specify a scalar value, that value is the initial value for all channels. The channels are set to the initial values between the time the model is downloaded and the time it is started.

**Sample time** — Base sample time or a multiple of the base sample time.

**Base address** — Enter the base address of the board. This entry must correspond to the base address DIP switch settings on the board. For example, if the base address is 2C0 (hexadecimal), enter

0x2C0

Note that the Sensoray 526 board ships from the manufacturer with a base address of 0x2C0. If you want to change the base address, see the board manufacturer documentation for allowed values.

## Sensoray526 Dual DA

The Sensoray526 Dual AD block controls two boards simultaneously. This enables the block to write the output registers to both boards before the conversion start bits are written on both boards.

Output from the second board changes state approximately 1 to 2 microseconds after the first board. This change is independent of the number of channels in use.

## Scaling of Input to Output

| Hardware Output | Block Input Data Type | Scaling |
|-----------------|-----------------------|---------|
| volts [-10,+10] | Double [-10,+10]      | 1       |

### Driver Block Parameters

**Board A Channels/Board B Channels** — Enter a vector of numbers between 1 and 4. Do not repeat any channel number. For example, to use the first, second and fourth channels, enter

[ 1, 2, 4 ]

Number the channels beginning with 1 even though the board manufacturer numbers them beginning with 0.

**Board A Reset vector/Board B Reset vector** — The reset vector controls the behavior of the channel at model termination. Enter a scalar or a vector that is the same length as the channel vector. If you specify a scalar value, that setting is used for all channels. If you specify a value of 1, the corresponding channel is reset to the value specified in the initial value vector. If you specify a value of 0, the channel remains at the last value attained while the model was running.

**Board A Initial value vector/Board B Initial value vector** — The initial value vector contains the initial voltage values for the output channels. At initialization, the block always uses this value. If **Reset vector** has a value of 1, the board sets the corresponding channel to the value of the **Initial value vector** when execution stops. Enter a double precision voltage value in the range -10 to +10. This must be scalar or a vector that is the same length as the channel vector. If you specify a scalar value, that value is the initial value for all channels. The channels are set to the initial values between the time the model is downloaded and the time it is started.

**Sample time** — Base sample time or a multiple of the base sample time.

**Base address** — Enter the base address of the board. This entry must correspond to the base address DIP switch settings on the board. For example, if the base address is 2C0 (hexadecimal), enter

0x2C0

Note that the Sensoray 526 board ships from the manufacturer with a base address of 0x2C0. If you want to change the base address, see the board manufacturer documentation for allowed values. For dual boards, change the base address of at least one of the boards. The boards cannot have the same base address.

## Sensoray526 DI

### Scaling of Input to Output

| Hardware Input      | Block Output Data Type | Scaling |
|---------------------|------------------------|---------|
| TTL (0 or +5) volts | Double (0 or 1)        | 1       |

### Driver Block Parameters

**Channels** — Enter a vector of numbers between 1 and 8. These are the channels to which the board writes output. Each group, 1 to 4 and 5 to 8, can be either input or output. Do not combine them. For example, if channels 1 to 4 are the input channels, you cannot have output on channel 2. Instead, you can use channels 5 to 8 to be the output channels.

Number the channels beginning with 1 even though the board manufacturer numbers them beginning with 0.

**Sample time** — Base sample time or a multiple of the base sample time.

**Base address** — Enter the base address of the board. This entry must correspond to the base address DIP switch settings on the board. For example, if the base address is 2C0 (hexadecimal), enter

0x2C0

Note that the Sensoray 526 board ships from the manufacturer with a base address of 0x2C0. If you want to change the base address, see the board manufacturer documentation for allowed values.

## Sensoray526 DO

### Scaling of Input to Output

| Hardware Output     | Block Input Data Type                                          | Scaling |
|---------------------|----------------------------------------------------------------|---------|
| TTL (0 or +5) volts | input < 0.5, output = 0 volts<br>input ≥ 0.5, output = 5 volts | 1       |

### Driver Block Parameters

**Channels** — Enter a vector of numbers between 1 and 8. These are the channels to which the board writes output. Each group, 1 to 4 and 5 to 8, can be either input or output. Do not combine them. For example, if channels 1 to 4 are the input channels, you cannot have output on channel 2. Instead, you can use channels 5 to 8 to be the output channels.

Number the channels beginning with 1 even though the board manufacturer numbers them beginning with 0.

**Reset vector** — The reset vector controls the behavior of the channel at model termination. Enter a scalar or a vector that is the same length as the channel vector. If you specify a scalar value, that setting is used for all channels. If you specify a value of 1, the corresponding channel is reset to the value specified in the initial value vector. If you specify a value of 0, the channel remains at the last value attained while the model was running.

**Initial value vector** — The initial value vector contains the initial logic values for the output channels. At initialization, the block always uses this value. Enter a 0 or 1. If **Reset vector** has a value of 1, the board sets the corresponding channel to the value of the **Initial value vector** when execution stops. Enter a scalar or a vector that is the same length as the channel vector. If you specify a scalar value, that value is the initial value for all channels. The channels are set to the initial values between the time the model is downloaded and the time it is started.

**Sample time** — Base sample time or a multiple of the base sample time.



**Base address** — Enter the base address of the board. This entry must correspond to the base address DIP switch settings on the board. For example, if the base address is 2C0 (hexadecimal), enter

0x2C0

Note that the Sensoray 526 board ships from the manufacturer with a base address of 0x2C0. If you want to change the base address, see the board manufacturer documentation for allowed values.

## Sensoray526 Encoder Input

### Driver Block Parameters

**Channel** — From the list, select 1, 2, 3, or 4. This parameter specifies the encoder input channel that this block reads.

**Index reset mode** — From the list, choose one of the following. This is the event on the index input that resets the counter to the value of **Reset value**.

- Rising edge on index
- Falling edge on index
- Both edges
- None

**Reset value** — The reset value contains the value of the counter when the event that the **Index reset mode** parameter specifies occurs on the index input.

**Initial value** — The initial value vector contains the value that is initially loaded into the counter when model execution starts. The counter is set to the initial value between the time the model is downloaded and the time it is started.

**Output range** — This parameter controls the way the 24-bit integer count is converted to the double precision signal output. From the list, select

- Signed  $\pm 2^{23}$  — If the block interprets the high order bit as a sign bit, the output takes values in the range  $-2^{23}$  to  $(+2^{23})-1$ .
- Unsigned  $0 \rightarrow 2^{24}-1$  — If the block interprets the 24-bit counter as an unsigned quantity, the output is in the range 0 to  $(2^{24})-1$ .

**Count speed** — From the list, select a counting mode. Choose one of the following:

- 1x — If counting up, count on the rising edge of CLKA. If counting down, count on the falling edge of CLKA.
- 2x — Count both edges of CLKA, up or down.
- 4x — Count both edges of both CLKA and CLKB, up or down.

Refer to the board manufacturer documentation for details on the counting mode.

**Sample time** — Base sample time or a multiple of the base sample time.

**Base address** — Enter the base address of the board. This entry must correspond to the base address DIP switch settings on the board. For example, if the base address is 2C0 (hexadecimal), enter

0x2C0

Note that the Sensoray 526 board ships from the manufacturer with a base address of 0x2C0. If you want to change the base address, see the board manufacturer documentation for allowed values.

## 626

The Sensoray 626 is a multifunction I/O board. It has 16 14-bit differential analog inputs, four 13-bit analog outputs, three pairs of 24-bit up/down counters (total of six counters), 48 digital I/O channels, watchdog timer, and backup battery support.

You can have up to four Sensoray 626 boards in your system.

xPC Target supports this board with these driver blocks:

- “Sensoray 626 Initialize” on page 27-11
- “Sensoray 626 Analog Input” on page 27-12
- “Sensoray 626 Analog Output” on page 27-13
- “Sensoray 626 Digital Input” on page 27-14
- “Sensoray 626 Digital Output” on page 27-14
- “Sensoray 626 Encoder” on page 27-15
- “Sensoray 626 PWM Capture” on page 27-16

### Board Characteristics

|                                 |               |
|---------------------------------|---------------|
| Board name                      | 626           |
| Manufacturer                    | Sensoray      |
| Bus type                        | PCI           |
| Access method                   | Memory mapped |
| Multiple block instance support | No            |
| Multiple board support          | Yes           |

### Sensoray 626 Initialize

You must use a Sensoray 626 Initialize block for every physical board that the model uses. One model can have up to four Sensoray 626 Initialize blocks.

#### Driver Block Parameters

**Board** — From the list, select 1, 2, 3, or 4 to represent which of the physical Sensoray 626 boards you want to initialize. Note that this board number is

arbitrary. You can reference a physical board as 1, 2, 3, or 4. However, you must be consistent in your board number choice throughout the model.

**Board rev A** — Select this check box if the board you are initializing is a Revision A board. Otherwise, leave this check box unselected.

**PCI Slot (-1:autosearch)** — If only one board of this type is physically present in the target PC, enter

-1

to automatically locate the board.

If two or more boards of this type are physically present in the target PC, enter the bus number and the PCI slot number of the board associated with this driver block. Use the format [BusNumber, SlotNumber]. To determine the bus number and the PCI slot number, type

```
getxpcpci
```

Note that the Device ID of this board is 0x7146.

## Sensoray 626 Analog Input Driver Block Parameters

**Board** — From the list, select 1, 2, 3, or 4 to represent which of the physical Sensoray 626 boards you want to use. Note that you must also add to the model an Initialize block for the same board.

**Channel vector** — Enter a vector of numbers between 1 and 16. This driver allows the selection of individual analog input lines in any order. The number of elements identifies the number of analog input channels used. For example, to use three analog input channels, enter

```
[1, 2, 3]
```

Number the channels beginning with 1 even though the board manufacturer numbers them beginning with 0.

**Range vector** — **Range vector** — Enter a range code for each of the channels in the channel vector. The value can be a scalar or a vector that must be the same length as the channel vector. If you specify a scalar value, that setting is used for all channels.

The following table is a list of the ranges for this driver and the corresponding range codes.

| Input Range (V) | Range Code |
|-----------------|------------|
| -5 to +5        | -5         |
| -10 to +10      | -10        |

For example, if the first channel is -10 to +10 volts, and the second channel is 0 to 5 volts, enter

[ -10,5]

**Sample time** — Base sample time or a multiple of the base sample time.

## Sensoray 626 Analog Output

### Driver Block Parameters

**Board** — From the list, select 1, 2, 3, or 4 to represent which of the physical Sensoray 626 boards you want to use. Note that you must also add to the model an Initialize block for the same board.

**Channel vector** — Enter a vector of numbers between 1 and 4. This driver allows the selection of individual analog output lines in any order. The number of elements identifies the number of analog output channels used. For example, to use three analog output channels, enter

[1, 2, 3]

Number the channels beginning with 1 even though the board manufacturer numbers them beginning with 0.

**Reset vector** — The reset vector controls the behavior of the channel at model termination. Enter a scalar or a vector that is the same length as the channel vector. If you specify a scalar value, that setting is used for all channels. If you specify a value of 1, the corresponding channel is reset to the value specified in the initial value vector. If you specify a value of 0, the channel remains at the last value attained while the model was running.

**Initial value vector** — The initial value vector contains the initial value for each analog output channel when model execution starts. Enter a scalar or a

vector that is the same length as the channel vector. If you specify a scalar value, that setting is used for all channels. The channel is set to the initial value between the time the model is downloaded and the time it is started.

**Sample time** — Base sample time or a multiple of the base sample time.

## **Sensoray 626 Digital Input**

### **Driver Block Parameters**

**Board** — From the list, select 1, 2, 3, or 4 to represent which of the physical Sensoray 626 boards you want to use. Note that you must also add to the model an Initialize block for the same board.

**Channel vector** — Enter a vector of numbers between 1 and 48. This driver allows the selection of individual digital input lines in any order. The number of elements identifies the number of digital input channels used. For example, to use three digital input channels, enter

[1, 2, 3]

Number the channels beginning with 1 even though the board manufacturer numbers them beginning with 0.

**Sample time** — Base sample time or a multiple of the base sample time.

## **Sensoray 626 Digital Output**

### **Driver Block Parameters**

**Board** — From the list, select 1, 2, 3, or 4 to represent which of the physical Sensoray 626 boards you want to use. Note that you must also add to the model an Initialize block for the same board.

**Channel vector** — Enter a vector of numbers between 1 and 48. This driver allows the selection of individual digital output lines in any order. The number of elements identifies the number of digital output channels used. For example, to use three digital output channels, enter

[1, 2, 3]

Number the channels beginning with 1 even though the board manufacturer numbers them beginning with 0.

**Reset vector** — The reset vector controls the behavior of the channel at model termination. Enter a scalar or a vector that is the same length as the channel vector. If you specify a scalar value, that setting is used for all channels. If you specify a value of 1, the corresponding channel is reset to the value specified in the initial value vector. If you specify a value of 0, the channel remains at the last value attained while the model was running.

**Initial value vector** — The initial value vector contains the initial value for each digital output channel when model execution starts. Enter a scalar or a vector that is the same length as the channel vector. If you specify a scalar value, that setting is used for all channels. The channel is set to the initial value between the time the model is downloaded and the time it is started.

**Sample time** — Base sample time or a multiple of the base sample time.

## Sensoray 626 Encoder

### Driver Block Parameters

**Board** — From the list, select 1, 2, 3, or 4 to represent which of the physical Sensoray 626 boards you want to use. Note that you must also add to the model an Initialize block for the same board.

**Channel vector** — Enter a vector of numbers between 1 and 6. This driver allows the selection of individual encoder lines in any order. The number of elements identifies the number of encoder channels used. For example, to use three odd encoder input channels, enter

[1, 3, 5]

Number the channels beginning with 1 even though the board manufacturer numbers them beginning with 0.

**Count speed vector** — The count speed vector specifies a counting mode for the channel. Enter a scalar or a vector that is the same length as the channel vector. If you specify a scalar value, that setting is used for all channels. Choose one of the following.

| Code | Quadrature Type |
|------|-----------------|
| 1    | 1X quadrature   |

| Code | Quadrature Type |
|------|-----------------|
| 2    | 2X quadrature   |
| 4    | 4X quadrature   |

**Index reset mode vector** — This is the event on the index input that resets the channel to the value of the **Reset value vector** value. Enter a scalar or a vector that is the same length as the channel vector. If you specify a scalar value, that setting is used for all channels.

- Rising edge on index
- Falling edge on index
- Both edges
- None

**Reset value vector** — This parameter contains the preload value for the corresponding channel. This is the value to which the channel is set when the event specified by the **Index reset mode** parameter occurs. Enter a valid value, as a scalar or a vector, that is the same length as the channel vector. If you specify a scalar value, that setting is used for all channels.

**Sample time** — Base sample time or a multiple of the base sample time.

## Sensoray 626 PWM Capture

### Driver Block Parameters

**Board** — From the list, select 1, 2, 3, or 4 to represent which of the physical Sensoray 626 boards you want to use. Note that you must also add to the model an Initialize block for the same board.

**Channel vector** — Enter a vector of numbers between 1 and 3. For example, to use the first two channels, enter

```
[1, 2]
```



This parameter refers to one of the three pairs of 24-bit up/down counters (total of six counters). Each channel corresponds to a counter pair.

| Counter Pair | Channel |
|--------------|---------|
| 0A, 0B       | 1       |
| 1A, 1B       | 2       |
| 2A, 2B       | 3       |

When measuring a signal, connect that signal to the B+ pin of the second encoder. For example, for a Channel 1 input signal, connect the signal to Encoder (0B) B+, which is pin 5 of the J4 connector. Connect the signal ground to the GND pins (not to the B- pins). See the manufacturer documentation for this board for further information.

**Clock source vector** — This parameter specifies the clock source for the channel. Enter a scalar or a vector that is the same length as the channel vector. If you specify a scalar value, that setting is used for all channels. Choose one of the following.

| Clock Source Vector | Source              |
|---------------------|---------------------|
| 0                   | Internal 2MHz clock |
| 1                   | External clock      |

**Sample size vector** — This value specifies how many measurement samples the output for the channel is based on. For example, if the sample size for a channel is  $n$ , the board samples the signal  $n$  times, then returns as its output the number of times out of  $n$  that the signal was high.

Enter a scalar or a vector that is the same length as the channel vector. If you specify a scalar value, that setting is used for all channels.

**Sample time** — Base sample time or a multiple of the base sample time.



# Softing

---

Due to the complexity of CAN applications, the Softing (<http://www.softing.com>) board drivers that xPC Target supports are not described in this chapter. Instead, see the chapters “CAN I/O Support” and “CAN I/O Support for FIFO” for details.



# Systran

---

This chapter describes the Systran reflective shared memory boards supported by xPC Target (<http://www.systran.com>).

Before You Start (p. 29-2)

Guidelines for setting up structures for shared memory

SCRAMNet+ SC150 PCI (p. 29-5)

Real-time reflective PCI memory board with 2 MBytes of node memory

Shared Memory Structure Reference (p. 29-9)

Shared memory reference for structures

## Before You Start

xPC Target uses a model for reflective memory (also known as shared memory) that includes Simulink blocks, for the shared memory drivers, and MATLAB structures for defining shared memory and node initialization partitions. The topics in this section are

- “Create Shared Memory Partitions” on page 29-2 — Before you begin to use SCRAMNet+ SC150 shared memory blocks, define a partition structure that defines how you want to allocate shared memory.
- “Initialize Shared Memory Nodes” on page 29-4 — Before you begin to use SCRAMNet+ SC150 shared memory blocks, define a node initialization structure that defines how shared memory is allocated (partitioned) and how the board is configured.

### Create Shared Memory Partitions

To use the xPC Target SCRAMNet+ SC150 shared memory blocks to read, write, pack, or unpack data, you must define a partition structure. SCRAMNet+ SC150 shared memory drivers use MATLAB structures to define shared memory partitions. A partition structure describes how you want to allocate (or partition) the shared memory. xPC Target allocates shared memory with bundles of data that are packed into memory partitions. The following SCRAMNet+ SC150 blocks use shared memory partition structures:

- SC150 read/write
- SC150 pack/unpack

After you define the shared memory partitions, you can add SCRAMNet+ SC150 shared memory driver blocks to your Simulink model. Create a shared memory structure in one of the following ways. See “Shared Memory Partition Structure” on page 29-9 for the complete list of fields for the structure.

The following description refers to the `completepartitionstruct` command.  
Type

```
help completepartitionstruct
```

for a description of the command.

- Using the `completepartitionstruct` command at the MATLAB Command Window, create a default partition structure. For example, type

```
completepartitionstruct([], 'scramnet')
```

```
ans =
```

```

    Address: '0x0'
      Type: 'uint32'
      Size: '1'
  Alignment: '4'
      RIE: 'off'
      TIE: 'off'
  ExtTrigger1: 'off'
  ExtTrigger2: 'off'
      HIPRO: 'off'
    Internal: [1x1 struct]

```

- At the MATLAB Command Window, create a user-defined partition structure. The easiest way to do this is to create an M-file, partially define a structure, load that M-file into the MATLAB workspace, and supplement the resulting structure with a call to the `completepartitionstruct` function. For example

```

Partition(1).Address='0x5000';
Partition(1).Type='int8';
Partition(1).Size='10';
Partition(2).Type='uint16';
Partition(2).Size='5';
Partition(3).Type='double';
Partition(3).Size='3';
Partition(4).Type='uint8';
Partition(4).Size='[2, 3]';

```

This example defines a partition with four segments.

- The Address field is optional. Only specify this field for the first segment of a partition. The elements of a partition are defined as a continuous memory block from the first address. The following segments extrapolate their addresses from the first segment. If you have fragmented memory, use multiple partitions and SCRAMNet+ SC150 read/write blocks to work with the memory.
- The Type and Size fields are required for all fields in the partition structure.

- The base addresses of subsequent segments are fully defined by the data type, size, and alignment of the preceding segment.
- You can then call the `completepartitionstruct()` command to full populate the partition structure.

## Initialize Shared Memory Nodes

To use the xPC Target SCRAMNet+ SC150 shared memory, you must define a node initialization structure. SCRAMNet+ SC150 shared memory drivers use MATLAB structures to define shared memory node initializations. A node initialization structure describes the shared memory partition (see “Create Shared Memory Partitions” on page 29-2) and the SCRAMNet+ SC150 board configuration, including interrupt configurations. The following SCRAMNet+ SC150 block requires shared memory node initialization structures:

- SC150 init

After you define the node initialization partition, you can add SCRAMNet+ SC150 shared memory driver blocks to your Simulink model. Create a shared memory structure in one of the following ways. See “Shared Memory Node Initialization Structure” on page 29-14 for the complete list of fields for the structure.

The following description refers to the `completenodestruct` command. Type

```
help completenodestruct
```

for a description of the command.

- Using the `completenodestruct` command at the MATLAB Command Window, create a default node initialization structure. For example, type `node=completenodestruct([], 'scramnet')`

```
node =
```

```
    Interface: [1x1 struct]
    Partitions: [1x1 struct]
```

- A user-defined node structure, create with m-code or from the MATLAB Command Window and supplement the resulting structure with a call to the `completenodestruct` function.



## SCRAMNet+ SC150 PCI

The SCRAMNet+ SC150 PCI board is a real-time reflective PCI memory board. It can also generate/broadcast interrupts. xPC Target uses this board as part of the shared memory network that you can use to exchange data between computer nodes.

xPC Target supports this board with these driver blocks:

- “SC150 init” on page 29-5
- “SC150 read” on page 29-6
- “SC150 write” on page 29-7
- “Shared Memory Pack” on page 29-8
- “Shared Memory Unpack”

For information about the Change endianness block, see “Byte Reversal/Change Endianness Block” in Chapter 6.

### Board Characteristics

|                                 |                 |
|---------------------------------|-----------------|
| Board name                      | SCRAMNet+ SC150 |
| Manufacturer                    | Systran         |
| Bus type                        | PCI             |
| Access method                   | Memory mapped   |
| Multiple block instance support | Yes             |
| Multiple board support          | Yes             |

## SC150 init

### Driver Block Parameters

Before you begin to configure these block parameters, be sure that you have a predefined node initialization structure. See “Initialize Shared Memory Nodes” on page 29-4.

Each model that uses shared memory must have one SC150 init block for every SCRAMNet+ SC150 board in the system.

**Node struct** — Enter the name of the predefined node initialization structure.

**PCI Slot (-1:autosearch)** — If only one board of this type is physically present in the target PC, enter

-1

to automatically locate the board.

If two or more boards of this type are physically present in the target PC, enter the bus number and the PCI slot number of the board associated with this driver block. Use the format [BusNumber, SlotNumber]. To determine the bus number and the PCI slot number, type

```
getxpcpci
```

## SC150 read

### Driver Block Parameters

Before you begin to configure this block, be sure that you have a predefined shared memory partition structure. The SC150 read block requires this structure to specify how Simulink signal values are mapped in the shared memory. It also uses this structure to determine the total size and address of the shared memory. See “Create Shared Memory Partitions” on page 29-2.

**Partition struct** — Enter the name of the predefined shared memory partition structure. The block uses this structure to specify how Simulink signal values map into shared memory.

**Sampletime** — Enter the base sample time or a multiple of the base sample time.

**PCI Slot (-1:autosearch)** — If only one board of this type is physically present in the target PC, enter

-1

to automatically locate the board.

If two or more boards of this type are physically present in the target PC, enter the bus number and the PCI slot number of the board associated with this driver block. Use the format [BusNumber, SlotNumber]. To determine the bus number and the PCI slot number, type

```
getxpcpci
```

## SC150 write

### Driver Block Parameters

Before you begin to configure this block, be sure that you have a predefined shared memory partition structure. The SC150 write block requires this structure to specify how Simulink signal values are mapped in the shared memory. It also uses this structure to determine the total size and address of the shared memory. See “Create Shared Memory Partitions” on page 29-2.

**Partition struct** — Enter the name of the predefined shared memory partition structure. The block uses this structure to specify how Simulink signal values map into shared memory.

**Sampletime** — Enter the base sample time or a multiple of the base sample time.

**PCI Slot (-1:autosearch)** — If only one board of this type is physically present in the target PC, enter

```
-1
```

to automatically locate the board.

If two or more boards of this type are physically present in the target PC, enter the bus number and the PCI slot number of the board associated with this driver block. Use the format [BusNumber, SlotNumber]. To determine the bus number and the PCI slot number, type

```
getxpcpci
```

## Shared Memory Pack

Before you begin to configure this block, be sure that you have a predefined shared memory partition structure.

Memory partitions consist of groups of Simulink signals, which are combined into blocks (packets) of 32 bit words. The SC150 pack block packs the specified partition structure into an unstructured double word array vector by converting one or more Simulink signals of varying data types into the vector. Typically, the input to a pack block is the output from a write block. Simulink is not aware of structures; you must pass the output of each structure segment as input to the SC150 pack block.

This block ignores the **Address** field of the partition structure.

### Driver Block Parameters

**Partition struct** — Enter the name of the predefined shared memory partition structure.

## Shared Memory Unpack

Before you begin to configure this block, be sure that you have a predefined shared memory partition structure.

The SC150 unpack block unpacks an unstructured double word array vector (from the SC150 pack block) into the specified partition structure. This block ignores the **Address** field of the partition structure.

### Driver Block Parameters

**Partition struct** — Enter the name of the predefined shared memory partition structure. The block unpacks the double word array vector into this structure.

## Shared Memory Structure Reference

You do not need to use all the fields of a partition or node initialization structure. However, knowing the possible structure fields will be helpful when you are creating any of the structures.

This section includes the following topics:

- “Shared Memory Partition Structure” on page 29-9 — Description of the partition node structure fields
- “Shared Memory Node Initialization Structure” on page 29-14 — Description of the node initialization structure fields

### Shared Memory Partition Structure

A shared memory partition structure has the following fields:

```
Address: '0x0'  
Type: 'uint32'  
Size: '1'  
Alignment: '4'  
RIE: 'off'  
TIE: 'off'  
ExtTrigger1: 'off'  
ExtTrigger2: 'off'  
HIPRO: 'off'  
Internal: [1x1 struct]
```

where

| <b>Partition Fields</b> | <b>Description</b>                                                                                                                                                                                                                                                                                                                                                                                                                                |
|-------------------------|---------------------------------------------------------------------------------------------------------------------------------------------------------------------------------------------------------------------------------------------------------------------------------------------------------------------------------------------------------------------------------------------------------------------------------------------------|
| <b>Address</b>          | Specifies the base address (in hexadecimal) of the memory partition within the node's shared memory space. The default value is '0x0', the first location in shared memory. Note that the base address is byte aligned.                                                                                                                                                                                                                           |
| <b>Type</b>             | <p>Specifies the data type of the memory segment. Specify one of the following types:</p> <ul style="list-style-type: none"> <li>• double</li> <li>• float</li> <li>• uint8</li> <li>• int8</li> <li>• uint16</li> <li>• int16</li> <li>• uint32</li> <li>• int32</li> <li>• boolean (a single byte represents a boolean value)</li> </ul> <p>The default value is 'uint32'. A minimum partition size is 32 bits.</p>                             |
| <b>Size</b>             | <p>Specifies the dimension and size of the memory segment. You can enter a scalar value or a value with the [m,n] format. The default value is '1'.</p> <ul style="list-style-type: none"> <li>• scalar — Treats the Size entry as the specification of the length of a non-oriented array or vector</li> <li>• [m,n] — Treats the Size entry as an array dimension. The total number of elements in this segment is <math>m*n</math>.</li> </ul> |

| <b>Partition Fields</b> | <b>Description</b>                                                                                                                                                                                                                                                                                                                                                                                                                                                                                                                                                                                                                                         |
|-------------------------|------------------------------------------------------------------------------------------------------------------------------------------------------------------------------------------------------------------------------------------------------------------------------------------------------------------------------------------------------------------------------------------------------------------------------------------------------------------------------------------------------------------------------------------------------------------------------------------------------------------------------------------------------------|
| <b>Alignment</b>        | If another partition precedes this partition, defines the byte alignment of this segment. Specify one of the following alignment values: 1, 2, 3, or 4. The default value is '4'. This value forces a double word boundary alignment for all elements.                                                                                                                                                                                                                                                                                                                                                                                                     |
| <b>RIE</b>              | <p>Specifies whether or not this partition can receive interrupts (Receive Interrupt Register (RIE)). Specify 'off', 'first', 'all', 'last'. The default value is 'off'.</p> <p>'off' — Prevents the partition from receiving interrupts</p> <p>'first' — Allows only the first double word of the memory segment to be marked with the corresponding Auxiliary Control RAM bit.</p> <p>'all' — Allows all memory locations of the memory segment to be marked with the corresponding Auxiliary Control RAM bit.</p> <p>'last' — Allows only the last double word of the memory segment to be marked with the corresponding Auxiliary Control RAM bit.</p> |

| <b>Partition Fields</b> | <b>Description</b>                                                                                                                                                                                                                                                                                                                                                                                                                                                                                                                                                                                                                                                                               |
|-------------------------|--------------------------------------------------------------------------------------------------------------------------------------------------------------------------------------------------------------------------------------------------------------------------------------------------------------------------------------------------------------------------------------------------------------------------------------------------------------------------------------------------------------------------------------------------------------------------------------------------------------------------------------------------------------------------------------------------|
| <b>TIE</b>              | <p>Specifies whether or not this partition can receive interrupts (Transmit Enable (TIE)). Specify 'off', 'first', 'all', 'last'. The default value is 'off'.</p> <p>'off' — Prevents the partition from receiving interrupts</p> <p>'first' — Allows only the first double word of the memory segment to be marked with the corresponding Auxiliary Control RAM bit.</p> <p>'all' — Allows all memory locations of the memory segment to be marked with the corresponding Auxiliary Control RAM bit.</p> <p>'last' — Allows only the last double word of the memory segment to be marked with the corresponding Auxiliary Control RAM bit.</p>                                                  |
| <b>ExtTrigger1</b>      | <p>If this partition receives a write access, specifies whether or not this partition can generate a trigger signal to an external connector. Specify 'off', 'first', 'all', 'last'. The default value is 'off'.</p> <p>'off' — Prevents the partition from generating signals</p> <p>'first' — Allows only the first double word of the memory segment to be marked with the corresponding Auxiliary Control RAM bit.</p> <p>'all' — Allows all memory locations of the memory segment to be marked with the corresponding Auxiliary Control RAM bit.</p> <p>'last' — Allows only the last double word of the memory segment to be marked with the corresponding Auxiliary Control RAM bit.</p> |



| <b>Partition Fields</b> | <b>Description</b>                                                                                                                                                                                                                                                                                                                                                                                                                                                                                                                                                                                                                                                                               |
|-------------------------|--------------------------------------------------------------------------------------------------------------------------------------------------------------------------------------------------------------------------------------------------------------------------------------------------------------------------------------------------------------------------------------------------------------------------------------------------------------------------------------------------------------------------------------------------------------------------------------------------------------------------------------------------------------------------------------------------|
| <b>ExtTrigger2</b>      | <p>If this partition receives a write access, specifies whether or not this partition can generate a trigger signal to an external connector. Specify 'off', 'first', 'all', 'last'. The default value is 'off'.</p> <p>'off' — Prevents the partition from generating signals</p> <p>'first' — Allows only the first double word of the memory segment to be marked with the corresponding Auxiliary Control RAM bit.</p> <p>'all' — Allows all memory locations of the memory segment to be marked with the corresponding Auxiliary Control RAM bit.</p> <p>'last' — Allows only the last double word of the memory segment to be marked with the corresponding Auxiliary Control RAM bit.</p> |
| <b>HIPRO</b>            | <p>Specifies whether or not the elements in this partition can be transmitted as one network message. Specify 'off', or 'on'. The default value is 'off'.</p> <p>'off' — Prevents the partition from transmitting the elements as one message</p> <p>'on' — Allows the partition to transmit the elements as one message</p>                                                                                                                                                                                                                                                                                                                                                                     |
| <b>Internal</b>         | Reserved for internal use.                                                                                                                                                                                                                                                                                                                                                                                                                                                                                                                                                                                                                                                                       |

## Shared Memory Node Initialization Structure

A node initialization structure has the following fields:

```
Interface: [1x1 struct]
Partitions: [1x1 struct]
```

where

| <b>Node Structure Fields</b> | <b>Description</b>                                                                                                                                                                                                                                                                                                                                                                                                                                                                                                                                                                                                                                                                                                                                                                                                                                                                                        |
|------------------------------|-----------------------------------------------------------------------------------------------------------------------------------------------------------------------------------------------------------------------------------------------------------------------------------------------------------------------------------------------------------------------------------------------------------------------------------------------------------------------------------------------------------------------------------------------------------------------------------------------------------------------------------------------------------------------------------------------------------------------------------------------------------------------------------------------------------------------------------------------------------------------------------------------------------|
| <b>Interface</b>             | <p>Specifies settings for the board Control/Status Register (CSR). The Interface structure has the following fields. Refer to the SCRAMNet+ SC150 product documentation for a description of the CSR and its operation modes.</p> <ul style="list-style-type: none"> <li>• <b>Mode</b> — Configures board modes (see “Board Mode” on page 29-14)</li> <li>• <b>Timeout</b> — Enables the board to set the timeout value (see “Board Timeout” on page 29-16)</li> <li>• <b>DataFilter</b> — Controls the data filtering operation (see “Board Data Filter” on page 29-17)</li> <li>• <b>VirtualPaging</b> — Controls the board virtual paging operation (see “Virtual Paging” on page 29-18)</li> <li>• <b>Interrupts</b> — Enables the board to generate and receive interrupts from the network (see “Board Interrupts” on page 29-18)</li> <li>• <b>Internal</b> — Reserved for internal use</li> </ul> |
| <b>Partitions</b>            | <p>Stores the shared memory segments (see “Create Shared Memory Partitions” on page 29-2)</p>                                                                                                                                                                                                                                                                                                                                                                                                                                                                                                                                                                                                                                                                                                                                                                                                             |

### Board Mode

The SCRAMNet+ SC150 board has a number of modes that you can set through the `Interface.Mode` field. The `Interface.Mode` fields set the corresponding bits in the CSR. To display the board mode fields, type

```

>> node.Interface.Mode
ans =
    NetworkCommunicationsMode: 'TransmitReceive'
        InsertNode: 'on'
    DisableFiberOpticLoopback: 'on'
        EnableWireLoopback: 'off'
    DisableHostToMemoryWrite: 'off'
        WriteOwnSlotEnable: 'off'
    MessageLengthLimit: '256'
    VariableLengthMessagesOnNetwork: 'off'
        HIPROEnable: 'off'
        MultipleMessages: 'on'
    NoNetworkErrorCorrection: 'on'
    MechanicalSwitchOverride: 'on'
        DisableHoldoff: 'on'

```

These modes have the following values:

| Field                            | Values                                                                | Default           | CSR         |
|----------------------------------|-----------------------------------------------------------------------|-------------------|-------------|
| <b>NetworkCommunicationsMode</b> | 'none',<br>'receiveonly',<br>'transmitonly',<br>'transmit<br>receive' | 'transmitreceive' | CSR3[8..15] |
| <b>InsertNode</b>                | 'off', 'on'                                                           | 'on'              | CSR0[0..1]  |
| <b>DisableFiberOpticLoopback</b> | 'off', 'on'                                                           | 'on'              | CSR2[6]     |
| <b>EnableWireLoopback</b>        | 'off', 'on'                                                           | 'off'             | CSR2[7]     |
| <b>DisableHostToMemoryWrite</b>  | 'off', 'on'                                                           | 'off'             | CSR2[8]     |
| <b>WriteOwnSlotEnable</b>        | 'off', 'on'                                                           | 'off'             | CSR2[9]     |

| <b>Field</b>                              | <b>Values</b> | <b>Default</b> | <b>CSR</b> |
|-------------------------------------------|---------------|----------------|------------|
| <b>Message LengthLimit</b>                | '256', '1024' | '256'          | CSR2[11]   |
| <b>Variable Length MessagesOn Network</b> | 'off', 'on'   | 'off'          | CSR2[12]   |
| <b>HIPROEnable</b>                        | 'off', 'on'   | 'off'          | CSR2[13]   |
| <b>Multiple Messages</b>                  | 'off', 'on'   | 'on'           | CSR2[14]   |
| <b>NoNetwork Error Correction</b>         | 'off', 'on'   | 'on'           | CSR2[15]   |
| <b>Mechanical Switch Override</b>         | 'off', 'on'   | 'on'           | CSR8[11]   |
| <b>Disable Holdoff</b>                    | 'off', 'on'   | 'on'           | CSR8[11]   |

### Board Timeout

The SCRAMNet+ SC150 board allows you to set the network timeout through the `Interface.Timeout` field. The `Interface.Timeout` fields set the corresponding bits in the CSR.

To display the timeout fields, type

```
>> node.Interface.Timeout
ans =
      NumOfNodesInRing: '2'
      TotalCableLengthInM: '2'
```

These fields have the following values:

| <b>Field</b>                    | <b>Values</b> | <b>Default</b> | <b>CSR</b> |
|---------------------------------|---------------|----------------|------------|
| <b>NumOfNodes<br/>InRing</b>    | '0'..'255'    | '2'            | CSR5       |
| <b>TotalCable<br/>LengthInM</b> | '0'..'n'      | '2'            | CSR5       |

Refer to the SCRAMNet+ SC150 product documentation for a description of these fields.

### Board Data Filter

The SCRAMNet+ SC150 board allows you to set the data filter operation through the `Interface.DataFilter` field. The `Interface.DataFilter` fields set the corresponding bits in the CSR.

```
>> node.Interface.DataFilter
ans =
      EnableTransmitDataFilter: 'off'
      EnableLower4KBytesForDataFilter: 'off'

>>
```

These fields have the following values:

| <b>Field</b>                                     | <b>Values</b> | <b>Default</b> | <b>CSR</b> |
|--------------------------------------------------|---------------|----------------|------------|
| <b>Enable<br/>TransmitData<br/>Filter</b>        | 'off', 'on'   | 'off'          | CSR0[10]   |
| <b>EnableLower4<br/>KBytesFor<br/>DataFilter</b> | 'off', 'on'   | 'off'          | CSR0[11]   |

## Virtual Paging

The SCRAMNet+ SC150 board allows you to set the bits of the Virtual Paging Register operation through the `Interface.VirtualPaging` field. The `Interface.VirtualPaging` fields set the corresponding bits in the CSR.

```
>> node.Interface.VirtualPaging
ans =
  VirtualPagingEnable: 'off'
  VirtualPageNumber: '0'
```

These fields have the following values:

| Field                       | Values      | Default | CSR          |
|-----------------------------|-------------|---------|--------------|
| <b>VirtualPaging Enable</b> | 'off', 'on' | 'off'   | CSR12[0]     |
| <b>VirtualPage Number</b>   | '0'..'2047' | '0'     | CSR12[5..15] |

## Board Interrupts

The SCRAMNet+ SC150 board allows you to specify the interrupt sources transmitted and received between the nodes of the network. You can set these bits through the `Interface.Interrupts` field. The `Interface.Interrupts` fields set the corresponding bits in the CSR.

```
>> node.Interface.Interrupts
ans =
  HostInterrupt: 'off'
  InterruptOnMemoryMaskMatch: 'off'
  OverrideReceiveInterrupt: 'off'
  InterruptOnError: 'off'
  NetworkInterrupt: 'off'
  OverrideTransmitInterrupt: 'off'
  InterruptOnOwnSlot: 'off'
  ReceiveInterruptOverride: 'off'
```

```
>>
```

These fields have the following values:

| <b>Field</b>                                | <b>Values</b> | <b>Default</b> | <b>CSR</b> |
|---------------------------------------------|---------------|----------------|------------|
| <b>HostInterrupt</b>                        | 'off', 'on'   | 'off'          | CSR0[3]    |
| <b>InterruptOn<br/>MemoryMask<br/>Match</b> | 'off', 'on'   | 'off'          | CSR0[5]    |
| <b>Override<br/>Receive<br/>Interrupt</b>   | 'off', 'on'   | 'off'          | CSR0[6]    |
| <b>InterruptOn<br/>Error</b>                | 'off', 'on'   | 'off'          | CSR0[7]    |
| <b>Network<br/>Interrupt</b>                | 'off', 'on'   | 'off'          | CSR0[8]    |
| <b>Override<br/>Transmit<br/>Interrupt</b>  | 'off', 'on'   | 'off'          | CSR0[9]    |
| <b>InterruptOn<br/>OwnSlot</b>              | 'off', 'on'   | 'off'          | CSR2[10]   |
| <b>Receive<br/>Interrupt<br/>Override</b>   | 'off', 'on'   | 'off'          | CSR8[10]   |





# United Electronic Industries (UEI)

---

This chapter describes the groups of boards supported by xPC target (<http://www.ueidaq.com>).

| Grouping the UEI Boards (p. 30-4) | Explanation of the grouping of the UEI boards                                                                                                                                                                                                                              |
|-----------------------------------|----------------------------------------------------------------------------------------------------------------------------------------------------------------------------------------------------------------------------------------------------------------------------|
| PD2-MF 12-Bit Series (p. 30-13)   | 16 or 64 single or 8 or 32 differential analog input (A/D) channels (12-bit) with a maximum sample rate of 1.25MHz. The gain varies from 1 to 8 or 1 to 1000. The boards also have 2 analog output (D/A) channels (12-bit), 16 digital input, and 16 digital output lines. |
| PD2-MF 14-Bit Series (p. 30-23)   | 16 or 64 single or 8 or 32 differential analog input (A/D) channels (14-bit). The gain varies from 1 to 8 or 1 to 1000. The boards also have 2 analog output (D/A) channels (12-bit), 16 digital input lines, and 16 digital output lines.                                 |
| PD2-MF 16-Bit Series (p. 30-33)   | 16 or 64 single or 8 or 32 differential analog input (A/D) channels (16-bit). The gain varies from 1 to 8 or 1 to 1000. The boards also have 2 analog output (D/A) channels (12-bit), 16 digital input, and 16 digital output lines.                                       |
| PD2-MFS 12-Bit Series (p. 30-43)  | 4 or 8 single analog input (A/D) channels (12-bit). The boards also have 2 analog output (D/A) channels (12-bit), 16 digital input, and 16 digital output lines.                                                                                                           |
| PD2-MFS 14-Bit Series (p. 30-53)  | 4 or 8 single analog input (A/D) channels (14-bit). The boards also have 2 analog output (D/A) channels (12-bit), 16 digital input, and 16 digital output lines.                                                                                                           |
| PD2-MFS 16-Bit Series (p. 30-63)  | 4 or 8 single analog input (A/D) channels (16-bit). The boards also have 2 analog output (D/A) channels (12-bit), 16 digital input, and 16 digital output lines.                                                                                                           |

|                                    |                                                                                                                                                                                                                                                                            |
|------------------------------------|----------------------------------------------------------------------------------------------------------------------------------------------------------------------------------------------------------------------------------------------------------------------------|
| PDXI-MF 12-Bit Series (p. 30-73)   | 16 or 64 single or 8 or 32 differential analog input (A/D) channels (12-bit) with a maximum sample rate of 1.25MHz. The gain varies from 1 to 8 or 1 to 1000. The boards also have 2 analog output (D/A) channels (12-bit), 16 digital input, and 16 digital output lines. |
| PDXI-MF 14-Bit Series (p. 30-83)   | 16 or 64 single or 8 or 32 differential analog input (A/D) channels (14-bit). The boards also have 2 analog output (D/A) channels (12-bit), 16 digital input, and 16 digital output lines.                                                                                 |
| PDXI-MF 16-Bit Series (p. 30-93)   | 16 or 64 single or 8 or 32 differential analog input (A/D) channels (16-bit). The boards also have 2 analog output (D/A) channels (12-bit), 16 digital input, and 16 digital output lines.                                                                                 |
| PDXI-MFS 12-Bit Series (p. 30-103) | 4 or 8 single analog input (A/D) channels (12-bit). The boards also have 2 analog output (D/A) channels (12-bit), 16 digital input, and 16 digital output lines.                                                                                                           |
| PDXI-MFS 14-Bit Series (p. 30-113) | 4 or 8 single analog input (A/D) channels (14-bit). The boards also have 2 analog output (D/A) channels (12-bit), 16 digital input, and 16 digital output lines.                                                                                                           |
| PDXI-MFS 16-Bit Series (p. 30-124) | 4 or 8 single analog input (A/D) channels (16-bit). The boards also have 2 analog output (D/A) channels (12-bit), 16 digital input, and 16 digital output lines.                                                                                                           |
| PD2-AO Series (p. 30-134)          | 8, 16, or 32 analog output (D/A) channels (16-bit) with a maximum sample rate of 100 kHz per channel. They also have 8 digital input and 8 digital output lines.                                                                                                           |
| PD2-DIO-64 (p. 30-139)             | 64 digital I/O channels in 16-bit ports, three counters/timers, two enhanced synchronous serial interface (ESSI) ports, and four high-speed (100 ns) IRQ lines.                                                                                                            |
| PD2-DIO-128 (p. 30-143)            | 128 digital I/O channels in 16-bit ports, three counters/timers, two enhanced synchronous serial interface (ESSI) ports, and four high-speed (100 ns) IRQ lines.                                                                                                           |

---

|                            |                                                                                                                                                                                 |
|----------------------------|---------------------------------------------------------------------------------------------------------------------------------------------------------------------------------|
| PD2-DIO-128i (p. 30-146)   | 64 optoisolated digital input and 64 optoisolated digital output ports in 16-bit ports.                                                                                         |
| PDL-DIO-64 (p. 30-149)     | Lab boards with 64 digital I/O channels in 16-bit ports, three counters/timers, two enhanced synchronous serial interface (ESSI) ports, and four high-speed (100 ns) IRQ lines. |
| PDXI-DIO-64 (p. 30-153)    | 64 digital I/O channels in 16-bit ports, three counters/timers, two enhanced synchronous serial interface (ESSI) ports, and four high-speed (100 ns) IRQ lines.                 |
| PDXI-AO Series (p. 30-157) | 8, 16, or 32 analog output (D/A) channels (16 bit) with a maximum sampling rate of 100 kHz per channel. They also have 8 digital input lines, and 8 digital output lines.       |

## Grouping the UEI Boards

The United Electronic Industries (UEI) PowerDAQ board series contains a large number of boards. The board names follow a standard pattern:

[Form Factor]-[Board Type]-[Channel]-[Speed]/[Resolution][Gain]

For example, one UEI board is named PD2-MF-16-1M/12L. The possibilities for the parts of the name are

- **Form Factor** — The form factor can be one of two things. PD2 denotes a 32-bit, 33-MHz PCI bus board. PDXI indicates a 32-bit, 33-MHz PXI/PCI bus board.
- **Board Type** — The board type can be one of three things. MF indicates a multifunction board. MFS indicates a multifunction board with sample and hold. AO indicates an analog output board.
- **Channel** — For MF and MFS board types, the channel is the number of analog input channels. For AO board types, the channel is the number of analog output channels.
- **Speed** — The speed is the number of samples per second supported by the board.
- **Resolution** — For MF and MFS boards, the Resolution is the analog input resolution. For AO board types, the Resolution is the analog output resolution.
- **Gain** — Gain is denoted by letters that represent ranges. DG indicates a gain of 1, 2, 5, or 10. L indicates a range of 1, 10, 100, or 1000. H indicates a range of 1, 2, 4, or 8.

For example, the PD2-MF-16-1M/12L is a PCI multifunction board with sixteen 12-bit analog input channels supporting one million (1M) samples per second with available gains of 1, 10, 100, or 1000.

### Changing the Board Associated with the Block

Note that the board displayed on the block is the current board type. To specify a different board, double-click on the block. In the **Board type** list, choose a different board.

### **Getting Information on a Specific Board**

The boards in this manual are grouped by Form Factor, Board Type, and Resolution. For more information on a specific board, open the MATLAB Help browser. Click on the **Search** tab. Verify that the **Product Filter** is set to **All** or that xPC Target is one of your selected products. In the **Search type** list, choose **Full Text**. In the **Search for** text box, type the name of your board. Click **Go**. Browse through the search results for more information on your board.

## Analog Input Frame Driver Blocks

The following UEI PowerDAQ board series have Analog Input frame driver blocks:

- PD2-MF — 12, 14, and 16-bit series
- PD2-MFS — 12, 14, and 16-bit series
- PDXI-MF — 12, 14, and 16-bit series
- PDXI-MFS — 12, 14, and 16-bit series

In frame-based mode, the boards for these driver blocks send interrupts to xPC Target. The xPC Target model is executed when each frame completes on the board. For proper use of the UEI frame driver blocks, note the IRQ values for each UEI board in the model and configure those boards appropriately with the model Configuration Parameters dialog. The topics in this section describe

- “Notes on Master and Slave Boards” on page 30-6 — Note the listed master and slave boards usage notes.
- “Interrupt Numbers” on page 30-7 — Look for and note the correct UEI board IRQ number. You use the number that the target machine BIOS assigns.
- “Interrupt Configuration” on page 30-9 — Configure the model with the correct UEI board IRQ number using the model simulation parameters dialog.
- “Example Models” on page 30-11 — Refer to the example UEI frame model examples in the xpcdemos directory.

### Notes on Master and Slave Boards

Before you begin, observe the following usage notes for the UEI boards in a master/slave configuration:

- You should set the slowest board as the master. If you do not want to use the slowest board as the master, you can explicitly set the **Acquisition frequency** parameter of the master board driver block to one that enables the slowest board in the configuration to work. You can derive the maximum speed of the board from the board name.
- Slave boards do not need to be identical to the master board.

- In the model, set the priority of slave blocks higher than master blocks. Right-click the slave or master block and select **Block Properties**. In the dialog, enter a value in the **Priority** property. For example, if you have multiple slave blocks, you can enter values of 2 for the slave blocks and 3 for the master block, where a lower number indicates a higher priority.
- The number of channels in use on the master does not need to be the same as those used on any of the slave boards.
- Connect the master and its slave(s) with the J6 connectors on the boards and the appropriate cables. This ensures that the acquisition clock and the scan clock from the master board is sent to all slave boards.
- The number of slaves you can have is limited by the number of connection points available on the cable and the availability of PCI slots.

## Interrupt Numbers

This topic describes how you determine the interrupt number to which the board is set. The methods vary depending on your hardware configuration.

This topic includes

- “Single UEI Board” on page 30-8 — How to use `getxpcpci` to get information about the PCI devices installed on the target machine. This method works if you have one UEI board in your system. The target machine BIOS assigns the IRQ number.
- “Guidelines for Multiple UEI Boards” on page 30-8 — How to get information about the PCI devices if you have two or more UEI boards configured in a master/slave configuration. This is an iterative method that requires you to reboot the target machine with the insertion of each UEI board.

---

**Note** To ensure that the PCI BIOS sets up the plugged-in PCI cards properly, disable (set to No) the Plug-and-Play (PnP) operating system feature. The xPC Target kernel is not a PnP operating system; you must ensure that this feature is disabled or PCI devices will not work on xPC Target.

---

### Single UEI Board

If you have one UEI board for your target machine, that board is the master.

- 1 Insert the UEI board in a slot of your target machine.
- 2 Reboot the target machine.
- 3 From the MATLAB Command Window, type

```
getxpcpci all
```

A list of the installed PCI devices and their relevant information is displayed. Included in this information is the IRQ. Note the IRQ number for the UEI board for which you are configuring the frame driver block.

- 4 Compare this board's IRQ number with the Ethernet Controller IRQ number, also listed in the `getxpcpci display`.

These numbers should not be the same. If they are, move the UEI board to another slot and reboot the target machine.

- 5 Assuming a unique IRQ UEI board number, note the IRQ, bus, and slot number for the UEI board.

Once you know your UEI board and its IRQ number, go to “Interrupt Configuration” on page 30-9 for further configuration details.

### Guidelines for Multiple UEI Boards

If you have two or more UEI boards in a master/slave configuration, you should try the following procedure. Note which UEI board you want to use as the master.

- 1 Insert a board into the target machine.
- 2 Reboot the target machine.
- 3 From a MATLAB Command Window running on the host machine, type  

```
getxpcpci all
```
- 4 Note the bus and slot information for the board you just installed.
- 5 Repeat Steps 1 to 4 for each UEI board you want in your configuration.



- 6 Note the IRQ for the UEI board you designate as the master after you install all the boards.
- 7 Check this board's IRQ number with the Ethernet Controller IRQ number, also listed in the `getxpcpci` display.

These numbers should not be the same. If they are, move the master UEI board to another slot, reboot the target machine, and check the master IRQ number again. Ignore the slave board IRQ numbers.

- 8 Assuming a unique IRQ UEI board number, note the IRQ, bus, and slot number for the UEI board.

Once you know the bus and slot information for the UEI boards, and the master's IRQ number, go to "Interrupt Configuration" on page 30-9 for further configuration details.

## Interrupt Configuration

After you add a frame block to a model, use the following procedures to set the simulation parameters to use the interrupt from the UEI board rather than the timer interrupt when running the model. This section assumes that you know the appropriate IRQ numbers for the boards you are configuring. If you do not, see "Interrupt Numbers" on page 30-7.

This topic includes

- "Simulation Parameters" on page 30-9 — If the UEI A/D frame block is not in a Function-Call Subsystem called from an IRQ Source block, use this procedure.
- "IRQ Source Block" on page 30-10 — If the UEI A/D frame block is in a Function-Call Subsystem called from an IRQ Source block, use this procedure.

### Simulation Parameters

If the UEI A/D frame block is not in a Function-Call Subsystem called from an IRQ Source block,

- 1 From the model, select **Simulation -> Configuration parameters**.

- 2** Select the **Real-Time Workshop** node.
- 3** In the **Target selection** section, from the **RTW system target file** list, browse to and select `xpctarget.tlc`.
- 4** In the **xPC Target options** node, from the **Real-time interrupt source** list, select the IRQ number you have jumpered on the board.

---

**Note** This number must not match the IRQ number for the Ethernet controller.

---

- 5** In the same node, from the **I/O board generating the interrupt** list, select the value `UEI-MFx`. This specifies that the UEI MFx board generates the interrupt.
- 6** In the same node, for the **PCI slot/ISA base address** parameter, enter the same PCI address as for the UEI MFx Frame block **PCI slot** parameter.
  - Only enter - 1 (for autodetection) if this is the only UEI board in the target system.
  - If more than one UEI board is or will be in the target system, enter the bus and slot number using the format `[bus, slot]`.
- 7** Click **OK** and save the model.

### **IRQ Source Block**

If the UEI A/D frame block is in a Function-Call Subsystem called from an IRQ Source block,

- 1** In the model, select the IRQ Source block.
- 2** From the **IRQ line number** list, select the IRQ number.
- 3** From the **I/O board generating the interrupt** list, select the value `UEI-MFx`. This specifies that a UEI MFx board generates the interrupt.

---

**Note** This number must not match the IRQ number for the Ethernet controller.

---

- 4 For the **PCI slot** parameter, enter the same PCI address as for the UEI MFx Frame block **PCI slot** parameter.
  - Only enter - 1 (for autodetection) if this is the only UEI board in the target system.
  - If more than one UEI board is or will be in the target system, enter the bus and slot number using the format [bus, slot].
- 5 Click **OK**.
- 6 Repeat this procedure for each IRQ Source block calling separate subsystems.

## Example Models

Example models that illustrate the use of UEI frame driver blocks are in the `xpcdemos` directory. Correct operation of these models requires that the interrupt source be set correctly in the simulation parameters dialog.

Note that these examples use the UEI PD2-MF-16-333/16H driver block. Replace the block as appropriate for your target system.

- `xpcUEIframe.mdl` — A simple frame-based model that outputs to an xPC Target scope. The model runs each time the board completes a frame of data.
- `xpcUEIMasterSlaveframe.mdl` — A master/slave frame-based model.
- `xpcUEIasync.mdl` — A model that implements a UEI A/D frame block in a Function-Call Subsystem called by an IRQ Source block. To set the interrupt for the UEI board, you work with the IRQ Source block parameters.

In this example, the interval at which the IRQ Source block triggers the Function-Call Subsystem is the board frame completion time. The rest of the model runs at the model sample time. This latter point implies that there may or may not be a new frame of output data in the output signal when the rest of the model executes. However, if you place all processing of the data in the Function-Call Subsystem, this is not an issue.

---

**Note** Even if the frame time at which the board runs is set to the same time as the model sample time, because the times derive from different sources they will drift relative to each other.

---

- `xpcUEIDualasync.mdl` — A model that implements multiple UEI A/D frame blocks in Function-Call Subsystems called by IRQ Source blocks. To set the interrupt for the UEI boards, you work with the IRQ Source block parameters.
- `xpcFrameLoop.mdl` — A model that illustrates how to perform sample-based processing on a frame of data. Because the fastest interrupt available is the frame completion interrupt, no part of the model can execute at a faster rate than frame completion. The For Iterator block executes once per frame completion and loops through the data.

## PD2-MF 12-Bit Series

The PD2-MF 12-bit series contains I/O boards with 16 or 64 single or 8 or 32 differential analog input (A/D) channels (12-bit) with a maximum sample rate of 1.25MHz. The gain varies from 1 to 8 or 1 to 1000. The boards also have 2 analog output (D/A) channels (12-bit), 16 digital input, and 16 digital output lines. xPC Target does not support the counter/timers on these boards.

xPC Target supports this series of boards with these driver blocks:

- “PD2-MF 12-Bit Series Analog Input (A/D)” on page 30-14
- “PD2-MF 12-Bit Series Frame Analog Input” on page 30-15
- “PD2-MF 12-Bit Series Analog Output (D/A)” on page 30-19
- “PD2-MF 12-Bit Series Digital Input” on page 30-20
- “PD2-MF 12-Bit Series Digital Output” on page 30-21

### Board Characteristics

|                                 |                                                                              |
|---------------------------------|------------------------------------------------------------------------------|
| Board type                      | PD2-MF-16-1M/12L<br>PD2-MF-16-1M/12H<br>PD2-MF-64-1M/12L<br>PD2-MF-64-1M/12H |
| Manufacturer                    | United Electronic Industries (UEI)                                           |
| Bus type                        | PCI                                                                          |
| Access method                   | Memory mapped                                                                |
| Multiple block instance support | No                                                                           |
| Multiple board support          | Yes                                                                          |

## PD2-MF 12-Bit Series Analog Input (A/D)

### Scaling Input to Output

| Hardware Input | Block Output Data Type | Scaling |
|----------------|------------------------|---------|
| volts          | Double                 | 1       |

### Driver Block Parameters

**Board type** — Select the specific board type from the list provided.

**Channel vector** — Enter a vector of numbers to specify the input channels. For example, use the first and third analog input (A/D) channels, enter

[1 3]

The channel numbers can occur in any order. Number the channels beginning with 1 even if the board manufacturer numbers them beginning with 0. The maximum allowable channel number is 4, 8, 16, or 64 depending on the board type.

**Gain vector** — Enter a vector of numbers to select the gains for each of the channels. Available gains vary depending on board type. MF PGL gains may be set to 1, 10, 100, or 1000. MF PGH gains may be set to 1, 2, 4, or 8. MF DG-option gains may be set to 1, 2, 5, or 10.

**Mux settling time factor** — This vector must be the same length as the channel vector. It contains values of 0 or 1. If 1, the corresponding channel has a longer settling time. This is useful when using a high gain such as 100 or 1000.

**Range** — Select the voltage range from the list provided. This applies to all channels.

**Sample time** — Enter the base sample time or a multiple of the base sample time.

**PCI Slot (-1:autosearch)** — If only one board of this type is physically present in the target PC, enter

-1

to automatically locate the board.

If two or more boards of this type are physically present in the target PC, enter the bus number and the PCI slot number of the board associated with this driver block. Use the format [BusNumber, SlotNumber]. To determine the bus number and the PCI slot number, type

```
getxpcpci
```

## PD2-MF 12-Bit Series Frame Analog Input

### Scaling Input to Output

| Hardware Input | Block Output Data Type | Scaling |
|----------------|------------------------|---------|
| volts          | Double                 | 1       |

### Driver Block Parameters

**Board type** — Select the specific board type from the list provided.

**Channel vector** — Enter a vector of numbers that make up one scan. For example, to read the first and fifth channels, enter

```
[1 5]
```

The channel numbers can occur in any order. Number the channels beginning with 1 even though the board manufacturer numbers them beginning with 0. The maximum allowable channel number is 4, 8, 16, or 64 depending on the board type.

**Gain vector** — Enter a vector of numbers to specify the gains for each of the channels in the scan. Enter a single value to use the same gain for all vectors in the scan. Available gains vary depending on board type. Allowable values depend on the board type.

- L (Low level) boards — Specify the gain as one of 1, 10, 100, or 1000.
- H (High level) boards — Specify the gain as one of 1, 2, 4, or 8.
- DG-option boards — Specify the gain as one of 1, 2, 5, or 10.

**Mux settling time vector (slow bit)** — Enter a vector that is the same length as the channel vector. Each vector element must be a 0 or 1. If you specify 1, the corresponding channel has a longer settling time. To get an accurate reading, you might want to specify a 1 for channels that have higher gains, such as 100 or 1000. Refer to the UEI PowerDAQ documentation for further information on the longer settling time. This time depends on the board type.

---

**Caution** With frame based acquisition, the additional time needed for the **Mux settling time vector (slow bit)** value might cause an acquisition overrun that xPC Target does not detect. For example, on a PD2-MF-xx-333/16H board, each nonslow acquisition takes 3 microseconds. If the slow bit is set to 1, that same acquisition takes more than 10 microseconds. With xPC Target, the scan is performed at the maximum rate for a given board. This means that the slow acquisition takes a multiple of 3 microsecond ticks. For a PD2-MF-xx-333/16H board, this becomes 12 microseconds.

For example, assume that  $N$  scans of the channel vector compose a frame of data. Assume also that you have a PD2-MF-xx-333/16H board with a **Channel vector** value of [1 2 3 4] and a **Mux settling time vector (slow bit)** value of [0 1 0 1]. For the PD2-MF-xx-333/16H board, two of the of the acquisition delays are 3 microseconds, and two are 12 microseconds. With a **Block sampletime** value of .001 second, if  $N$  is greater than 38, the data will not be acceptable. If you set all slow bits to 0,  $N$  can have a value of up to 83. The software detects the limit at  $N = 83$ , but is not aware of the extra board dependent delay.

---

**Range** — From the list, select one of the following voltage ranges. The value you select applies to all channels.

- +-10 Volts
- +-5 Volts
- 0-10 Volts
- 0-5 Volts

**Input coupling mode** — From the list, select one from the following list of input coupling modes:



- Single Ended
- Differential

Refer to the UEI PowerDAQ documentation for input connections.

**Frame size** — Enter the number of samples per channel to return as a frame of data. Due to constraints in the hardware architecture, the total number of samples in a frame of data cannot exceed 512. The relationship between the number of samples, frame size, and number of channels is

$$\text{total number of samples} = \text{FrameSize} \times \text{nChannels}$$

For example, if you specify two channels, the frame size must be less than or equal to 256.

**Output format** — From the list, select either Frame or Vector.

- Frame — Select Frame if you expect the output signal from this block to be the input signal for a block that requires a frame. For example, a Signal Processing block.
- Vector — Select Vector if you expect the output signal from this block to be the input signal for an xPC Target scope or some other block that requires vector input.

**Scan clock source** — Select Internal or External to identify the clock source for the frame scans.

**Scan time** — Enter the time (in seconds) between scans as the interval.

**Frame time** — Enter the interval (in seconds) during which the board will interrupt. The driver block evenly spaces the scans in the frame across the **Frame time** interval. If the **Frame time** interval is too short, you will receive a buffer overrun error at run time. For optimal results, experimentally increase the **Frame time** value and reiterate the process. Always rebuild the model when you change this value.

The **Frame size**, **Scan time**, and **Frame time** parameters are not independent, but are related by

$$\text{Frame time} = \text{Framesize} \times \text{Scan time}$$

After you specify two of the parameters, specify -1 for the third parameter and the equation determines the third parameter.

---

**Note** Because xPC Target uses this value to set hardware parameters on the board, you cannot change the **Frame time** value at the MATLAB prompt.

---

**Block is in an ISR** — Select this check box if the block is in an interrupt service routine (ISR). Selecting this check box forces the block sample time to -1, which enables the block to work in the ISR. If this check box is not selected, the block sample time is equal to the value of **Frame time**.

**Slave board** — If you have multiple boards configured in a master/slave combination, select this box for the slave boards only. Leave the box unchecked for the master board. (Note that a single board configuration is considered a master board.)

---

**Note** In the model, set the priority of slave blocks higher than master blocks. Right-click the slave or master block and select **Block Properties**. In the dialog, enter a value in the **Priority** property. For example, if you have multiple slave blocks, you can enter values of 2 for the slave blocks and 3 for the master block, where a lower number indicates a higher priority.

---

**Acquisition frequency** — Enter the rate at which the high speed conversion clock runs. This is the clock used to acquire each scan in a frame. For example, with a PD2-MF-xx-333/16H board, the maximum clock is 333 kHz. At that rate, the second channel in a scan will be acquired 3 microseconds after the first one in every scan of the frame.

Specify -1 to select the maximum rate available for the specified board.

**DMA burst size** — From the list, select either 32, 16, or 8. The DMA engine transfers data in packets of the burst size or less. Between each burst, a new bus arbitration cycle must complete. The best performance is achieved with higher **DMA burst size** values, with 32 being highest. However, in some architectures and with some PCI bus adaptors, a **DMA burst size** of 32 might cause problems. For example, it might lock up the target machine when DMA is attempted. In these cases, reduce the **DMA burst size** value to 8, rebuild and rerun the target application. If the DMA works at 8, select 16 to increase performance and try again.

**PCI Slot (-1:autosearch)** — If only one board of this type is physically present in the target PC, enter

-1

to automatically locate the board.

If two or more boards of this type are physically present in the target PC, enter the bus number and the PCI slot number of the board associated with this driver block. Use the format [BusNumber, SlotNumber]. To determine the bus number and the PCI slot number, type

```
getxpcpci
```

## PD2-MF 12-Bit Series Analog Output (D/A)

### Scaling Input to Output

| Hardware Output | Block Input Data Type | Scaling |
|-----------------|-----------------------|---------|
| volts           | Double                | 1       |

### Driver Block Parameters

**Board type** — Select the specific board type from the list provided.

**Channel vector** — Enter a vector of numbers to specify the output channels 1 or 2. For example, to use the first and second analog output (D/A) channels, enter

```
[1 2]
```

The channel numbers can occur in any order. Number the channels beginning with 1 even if the board manufacturer numbers them beginning with 0.

**Reset vector** — The reset vector must be the same length as the channel vector. It contains values of 0 or 1. This parameter controls the behavior at model termination. A value of 1 causes the corresponding channel to be reset to the value specified in the initial value vector. A value of 0 causes the channel to remain at the last value attained while the model was running.

**Initial value vector** — The initial value vector must be the same length as the channel vector and should contain the initial voltage values for the output channels. The channels are set to these values between the time the model is downloaded and the time it is started.

**Sample time** — Enter the base sample time or a multiple of the base sample time.

**PCI Slot (-1:autosearch)** — If only one board of this type is physically present in the target PC, enter

-1

to automatically locate the board.

If two or more boards of this type are physically present in the target PC, enter the bus number and the PCI slot number of the board associated with this driver block. Use the format [BusNumber, SlotNumber]. To determine the bus number and the PCI slot number, type

```
getxpcpci
```

## PD2-MF 12-Bit Series Digital Input

### Scaling Input to Output

| Hardware Input | Block Output Data Type | Scaling                         |
|----------------|------------------------|---------------------------------|
| TTL            | Double                 | TTL low = 0.0<br>TTL high = 1.0 |

### Driver Block Parameters

**Board type** — Select the specific board type from the list provided.

**Channel vector** — Enter a vector of numbers to specify the input channels. For example, to use the first and third digital input channels, enter

```
[1 3]
```

The channel numbers can occur in any order. Number the channels beginning with 1 even if the board manufacturer numbers them beginning with 0. The maximum allowable channel number is 16 for all boards except for the PD2-AO and PDXI-AO series. For those boards, the maximum channel number is 8.

**Sample time** — Enter the base sample time or a multiple of the base sample time.

**PCI Slot (-1:autosearch)** — If only one board of this type is physically present in the target PC, enter

-1

to automatically locate the board.

If two or more boards of this type are physically present in the target PC, enter the bus number and the PCI slot number of the board associated with this driver block. Use the format [BusNumber, SlotNumber]. To determine the bus number and the PCI slot number, type

```
getxpcpci
```

## PD2-MF 12-Bit Series Digital Output

### Scaling Input to Output

| Hardware Output | Block Input Data Type | Scaling                             |
|-----------------|-----------------------|-------------------------------------|
| TTL             | Double                | < 0.5 = TTL low<br>> 0.5 = TTL high |

### Driver Block Parameters

**Board type** — Select the specific board type from the list provided.

**Channel vector** — Enter a vector of numbers to specify the output channels. For example, to use the first and third digital output channels, enter

```
[1 3]
```

The channel numbers can occur in any order. Number the channels beginning with 1 even if the board manufacturer numbers them beginning with 0. The maximum allowable channel number is 16 for all board types except for the

PD2-AO and PDXI-AO series. For those boards, the maximum channel number is 8.

**Reset vector** — The reset vector must be the same length as the channel vector. It contains values of 0 or 1. This parameter controls the behavior at model termination. A value of 1 causes the corresponding channel to be reset to the value specified in the initial value vector. A value of 0 causes the channel to remain at the last value attained while the model was running.

**Initial value vector** — The initial value vector must be the same length as the channel vector. It contains the initial values (0 or 1) for the output channels. The channels are set to these values between the time the model is downloaded and the time it is started.

**Sample time** — Enter the base sample time or a multiple of the base sample time.

**PCI Slot (-1:autosearch)** — If only one board of this type is physically present in the target PC, enter

-1

to automatically locate the board.

If two or more boards of this type are physically present in the target PC, enter the bus number and the PCI slot number of the board associated with this driver block. Use the format [BusNumber, SlotNumber]. To determine the bus number and the PCI slot number, type

```
getxpcpci
```

## PD2-MF 14-Bit Series

The PD2-MF 14-bit series contains I/O boards with 16 or 64 single or 8 or 32 differential analog input (A/D) channels (14-bit). The gain varies from 1 to 8 or 1 to 1000. The boards also have 2 analog output (D/A) channels (12-bit), 16 digital input lines, and 16 digital output lines. xPC Target does not support the counter/timers on these boards.

xPC Target supports this series of boards with these driver blocks:

- “PD2-MF 14-Bit Series Analog Input (A/D)” on page 30-24
- “PD2-MF 14-Bit Series Frame Analog Input” on page 30-25
- “PD2-MF 14-Bit Series Analog Output (D/A)” on page 30-29
- “PD2-MF 14-Bit Series Digital Input” on page 30-30
- “PD2-MF 14-Bit Series Digital Output” on page 30-31

### Board Characteristics

|                                 |                                                                                                                          |
|---------------------------------|--------------------------------------------------------------------------------------------------------------------------|
| Board type                      | PD2-MF-16-400/14L<br>PD2-MF-16-400/14H<br>PD2-MF-64-400/14L<br>PD2-MF-64-400/14H<br>PD2-MF-16-2M/14H<br>PD2-MF-64-2M/14H |
| Manufacturer                    | United Electronic Industries (UEI)                                                                                       |
| Bus type                        | PCI, ISA                                                                                                                 |
| Access method                   | Memory mapped                                                                                                            |
| Multiple block instance support | No                                                                                                                       |
| Multiple board support          | Yes                                                                                                                      |

## PD2-MF 14-Bit Series Analog Input (A/D)

### Scaling Input to Output

| Hardware Input | Block Output Data Type | Scaling |
|----------------|------------------------|---------|
| volts          | Double                 | 1       |

### Driver Block Parameters

**Board type** — Select the specific board type from the list provided.

**Channel vector** — Enter a vector of numbers to specify the input channels. For example, use the first and third analog input (A/D) channels, enter

[1 3]

The channel numbers can occur in any order. Number the channels beginning with 1 even if the board manufacturer numbers them beginning with 0. The maximum allowable channel number is 4, 8, 16, or 64 depending on the board type.

**Gain vector** — Enter a vector of numbers to select the gains for each of the channels. Available gains vary depending on board type. MF PGL gains may be set to 1, 10, 100, or 1000. MF PGH gains may be set to 1, 2, 4, or 8. MF DG-option gains may be set to 1, 2, 5, or 10.

**Mux settling time factor** — This vector must be the same length as the channel vector. It contains values of 0 or 1. If 1, the corresponding channel has a longer settling time. This is useful when using a high gain such as 100 or 1000.

**Range** — Select the voltage range from the list provided. This applies to all channels.

**Sample time** — Enter the base sample time or a multiple of the base sample time.

**PCI Slot (-1:autosearch)** — If only one board of this type is physically present in the target PC, enter

-1

to automatically locate the board.



If two or more boards of this type are physically present in the target PC, enter the bus number and the PCI slot number of the board associated with this driver block. Use the format [BusNumber, SlotNumber]. To determine the bus number and the PCI slot number, type

```
getxpcpci
```

## PD2-MF 14-Bit Series Frame Analog Input

### Scaling Input to Output

| Hardware Input | Block Output Data Type | Scaling |
|----------------|------------------------|---------|
| volts          | Double                 | 1       |

### Driver Block Parameters

**Board type** — Select the specific board type from the list provided.

**Channel vector** — Enter a vector of numbers that make up one scan. For example, to read the first and fifth channels, enter

```
[1 5]
```

The channel numbers can occur in any order. Number the channels beginning with 1 even though the board manufacturer numbers them beginning with 0. The maximum allowable channel number is 4, 8, 16, or 64 depending on the board type.

**Gain vector** — Enter a vector of numbers to specify the gains for each of the channels in the scan. Enter a single value to use the same gain for all vectors in the scan. Available gains vary depending on board type. Allowable values depend on the board type.

- L (Low level) boards — Specify the gain as one of 1, 10, 100, or 1000.
- H (High level) boards — Specify the gain as one of 1, 2, 4, or 8.
- DG-option boards — Specify the gain as one of 1, 2, 5, or 10.

**Mux settling time vector (slow bit)** — Enter a vector that is the same length as the channel vector. Each vector element must be a 0 or 1. If you specify 1, the corresponding channel has a longer settling time. To get an accurate

reading, you might want to specify a 1 for channels that have higher gains, such as 100 or 1000. Refer to the UEI PowerDAQ documentation for further information on the longer settling time. This time depends on the board type.

---

**Caution** With frame based acquisition, the additional time needed for the **Mux settling time vector (slow bit)** value might cause an acquisition overrun that xPC Target does not detect. For example, on a PD2-MF-xx-333/16H board, each nonslow acquisition takes 3 microseconds. If the slow bit is set to 1, that same acquisition takes more than 10 microseconds. With xPC Target, the scan is performed at the maximum rate for a given board. This means that the slow acquisition takes a multiple of 3 microsecond ticks. For a PD2-MF-xx-333/16H board, this becomes 12 microseconds.

For example, assume that  $N$  scans of the channel vector compose a frame of data. Assume also that you have a PD2-MF-xx-333/16H board with a **Channel vector** value of [1 2 3 4] and a **Mux settling time vector (slow bit)** value of [0 1 0 1]. For the PD2-MF-xx-333/16H board, two of the of the acquisition delays are 3 microseconds, and two are 12 microseconds. With a **Block sampletime** value of .001 second, if  $N$  is greater than 38, the data will not be acceptable. If you set all slow bits to 0,  $N$  can have a value of up to 83. The software detects the limit at  $N = 83$ , but is not aware of the extra board dependent delay.

---

**Range** — From the list, select one of the following voltage ranges. The value you select applies to all channels.

- +-10 Volts
- +-5 Volts
- 0-10 Volts
- 0-5 Volts

**Input coupling mode** — From the list, select one from the following list of input coupling modes:

- Single Ended
- Differential

Refer to the UEI PowerDAQ documentation for input connections.

**Frame size** — Enter the number of samples per channel to return as a frame of data. Due to constraints in the hardware architecture, the total number of samples in a frame of data cannot exceed 512. The relationship between the number of samples, frame size, and number of channels is

$$\text{total number of samples} = \text{FrameSize} \times \text{nChannels}$$

For example, if you specify two channels, the frame size must be less than or equal to 256.

**Output format** — From the list, select either *Frame* or *Vector*.

- **Frame** — Select *Frame* if you expect the output signal from this block to be the input signal for a block that requires a frame. For example, a *Signal Processing* block.
- **Vector** — Select *Vector* if you expect the output signal from this block to be the input signal for an xPC Target scope or some other block that requires vector input.

**Scan clock source** — Select *Internal* or *External* to identify the clock source for the frame scans.

**Scan time** — Enter the time (in seconds) between scans as the interval.

**Frame time** — Enter the interval (in seconds) during which the board will interrupt. The driver block evenly spaces the scans in the frame across the **Frame time** interval. If the **Frame time** interval is too short, you will receive a buffer overrun error at run time. For optimal results, experimentally increase the **Frame time** value and reiterate the process. Always rebuild the model when you change this value.

The **Frame size**, **Scan time**, and **Frame time** parameters are not independent, but are related by

$$\text{Frametime} = \text{Framesize} \times \text{Scantime}$$

After you specify two of the parameters, specify -1 for the third parameter and the equation determines the third parameter.

---

**Note** Because xPC Target uses this value to set hardware parameters on the board, you cannot change the **Frame time** value at the MATLAB prompt.

---

**Block is in an ISR** — Select this check box if the block is in an interrupt service routine (ISR). Selecting this check box forces the block sample time to -1, which enables the block to work in the ISR. If this check box is not selected, the block sample time is equal to the value of **Frame time**.

**Slave board** — If you have multiple boards configured in a master/slave combination, select this box for the slave boards only. Leave the box unchecked for the master board. (Note that a single board configuration is considered a master board.)

---

**Note** In the model, set the priority of slave blocks higher than master blocks. Right-click the slave or master block and select **Block Properties**. In the dialog, enter a value in the **Priority** property. For example, if you have multiple slave blocks, you can enter values of 2 for the slave blocks and 3 for the master block, where a lower number indicates a higher priority.

---

**Acquisition frequency** — Enter the rate at which the high speed conversion clock runs. This is the clock used to acquire each scan in a frame. For example, with a PD2-MF-xx-333/16H board, the maximum clock is 333 kHz. At that rate, the second channel in a scan will be acquired 3 microseconds after the first one in every scan of the frame.

Specify -1 to select the maximum rate available for the specified board.

**DMA burst size** — From the list, select either 32, 16, or 8. The DMA engine transfers data in packets of the burst size or less. Between each burst, a new bus arbitration cycle must complete. The best performance is achieved with higher **DMA burst size** values, with 32 being highest. However, in some architectures and with some PCI bus adaptors, a **DMA burst size** of 32 might cause problems. For example, it might lock up the target machine when DMA is attempted. In these cases, reduce the **DMA burst size** value to 8, rebuild and rerun the target application. If the DMA works at 8, select 16 to increase performance and try again.

**PCI Slot (-1:autosearch)** — If only one board of this type is physically present in the target PC, enter

-1

to automatically locate the board.

If two or more boards of this type are physically present in the target PC, enter the bus number and the PCI slot number of the board associated with this driver block. Use the format [BusNumber, SlotNumber]. To determine the bus number and the PCI slot number, type

```
getxpcpci
```

## PD2-MF 14-Bit Series Analog Output (D/A)

### Scaling Input to Output

| Hardware Output | Block Input Data Type | Scaling |
|-----------------|-----------------------|---------|
| volts           | Double                | 1       |

### Driver Block Parameters

**Board type** — Select the specific board type from the list provided.

**Channel vector** — Enter a vector of numbers to specify the output channels 1 or 2. For example, to use the first and second analog output (D/A) channels, enter

```
[1 2]
```

The channel numbers can occur in any order. Number the channels beginning with 1 even if the board manufacturer numbers them beginning with 0.

**Reset vector** — The reset vector must be the same length as the channel vector. It contains values of 0 or 1. This parameter controls the behavior at model termination. A value of 1 causes the corresponding channel to be reset to the value specified in the initial value vector. A value of 0 causes the channel to remain at the last value attained while the model was running.

**Initial value vector** — The initial value vector must be the same length as the channel vector and should contain the initial voltage values for the output

channels. The channels are set to these values between the time the model is downloaded and the time it is started.

**Sample time** — Enter the base sample time or a multiple of the base sample time.

**PCI Slot (-1:autosearch)** — If only one board of this type is physically present in the target PC, enter

-1

to automatically locate the board.

If two or more boards of this type are physically present in the target PC, enter the bus number and the PCI slot number of the board associated with this driver block. Use the format [BusNumber, SlotNumber]. To determine the bus number and the PCI slot number, type

getxpcpci

## PD2-MF 14-Bit Series Digital Input

### Scaling Input to Output

| Hardware Input | Block Output Data Type | Scaling                         |
|----------------|------------------------|---------------------------------|
| TTL            | Double                 | TTL low = 0.0<br>TTL high = 1.0 |

### Driver Block Parameters

**Board type** — Select the specific board type from the list provided.

**Channel vector** — Enter a vector of numbers to specify the input channels. For example, to use the first and third digital input channels, enter

[1 3]

The channel numbers can occur in any order. Number the channels beginning with 1 even if the board manufacturer numbers them beginning with 0. The maximum allowable channel number is 16 for all boards except for the PD2-AO and PDXI-AO series. For those boards, the maximum channel number is 8.

**Sample time** — Enter the base sample time or a multiple of the base sample time.

**PCI Slot (-1:autosearch)** — If only one board of this type is physically present in the target PC, enter

-1

to automatically locate the board.

If two or more boards of this type are physically present in the target PC, enter the bus number and the PCI slot number of the board associated with this driver block. Use the format [BusNumber, SlotNumber]. To determine the bus number and the PCI slot number, type

```
getxpcpci
```

## PD2-MF 14-Bit Series Digital Output

### Scaling Input to Output

| Hardware Output | Block Input Data Type | Scaling                             |
|-----------------|-----------------------|-------------------------------------|
| TTL             | Double                | < 0.5 = TTL low<br>> 0.5 = TTL high |

### Driver Block Parameters

**Board type** — Select the specific board type from the list provided.

**Channel vector** — Enter a vector of numbers to specify the output channels. For example, to use the first and third digital output channels, enter

```
[1 3]
```

The channel numbers can occur in any order. Number the channels beginning with 1 even if the board manufacturer numbers them beginning with 0. The maximum allowable channel number is 16 for all board types except for the PD2-AO and PDXI-AO series. For those boards, the maximum channel number is 8.

**Reset vector** — The reset vector must be the same length as the channel vector. It contains values of 0 or 1. This parameter controls the behavior at model termination. A value of 1 causes the corresponding channel to be reset to the value specified in the initial value vector. A value of 0 causes the channel to remain at the last value attained while the model was running.

**Initial value vector** — The initial value vector must be the same length as the channel vector. It contains the initial values (0 or 1) for the output channels. The channels are set to these values between the time the model is downloaded and the time it is started.

**Sample time** — Enter the base sample time or a multiple of the base sample time.

**PCI Slot (-1:autosearch)** — If only one board of this type is physically present in the target PC, enter

-1

to automatically locate the board.

If two or more boards of this type are physically present in the target PC, enter the bus number and the PCI slot number of the board associated with this driver block. Use the format [BusNumber, SlotNumber]. To determine the bus number and the PCI slot number, type

```
getxpcpci
```



## PD2-MF 16-Bit Series

The PD2-MF 16-bit series contains I/O boards with 16 or 64 single or 8 or 32 differential analog input (A/D) channels (16-bit). The gain varies from 1 to 8 or 1 to 1000. The boards also have 2 analog output (D/A) channels (12-bit), 16 digital input, and 16 digital output lines. xPC Target does not support the counter/timers on these boards.

xPC Target supports this series of boards with these driver blocks:

- “PD2-MF 16-Bit Series Analog Input (A/D)” on page 30-34
- “PD2-MF 16-Bit Series Frame Analog Input” on page 30-35
- “PD2-MF 16-Bit Series Analog Output (D/A)” on page 30-39
- “PD2-MF 16-Bit Series Digital Input” on page 30-40
- “PD2-MF 16-Bit Series Digital Output” on page 30-41

### Board Characteristics

|                                 |                                                                                                                                                                                          |
|---------------------------------|------------------------------------------------------------------------------------------------------------------------------------------------------------------------------------------|
| Board type                      | PD2-MF-16-50/16H<br>PD2-MF-16-333/16L<br>PD2-MF-16-333/16H<br>PD2-MF-64-333/16L<br>PD2-MF-64-333/16H<br>PD2-MF-16-500/16L<br>PD2-MF-16-500/16H<br>PD2-MF-64-500/16L<br>PD2-MF-64-500/16H |
| Manufacturer                    | United Electronic Industries (UEI)                                                                                                                                                       |
| Bus type                        | PCI, ISA                                                                                                                                                                                 |
| Access method                   | Memory mapped                                                                                                                                                                            |
| Multiple block instance support | No                                                                                                                                                                                       |
| Multiple board support          | Yes                                                                                                                                                                                      |

## PD2-MF 16-Bit Series Analog Input (A/D)

### Scaling Input to Output

| Hardware Input | Block Output Data Type | Scaling |
|----------------|------------------------|---------|
| volts          | Double                 | 1       |

### Driver Block Parameters

**Board type** — Select the specific board type from the list provided.

**Channel vector** — Enter a vector of numbers to specify the input channels. For example, use the first and third analog input (A/D) channels, enter

[1 3]

The channel numbers can occur in any order. Number the channels beginning with 1 even if the board manufacturer numbers them beginning with 0. The maximum allowable channel number is 4, 8, 16, or 64 depending on the board type.

**Gain vector** — Enter a vector of numbers to select the gains for each of the channels. Available gains vary depending on board type. MF PGL gains may be set to 1, 10, 100, or 1000. MF PGH gains may be set to 1, 2, 4, or 8. MF DG-option gains may be set to 1, 2, 5, or 10.

**Mux settling time factor** — This vector must be the same length as the channel vector. It contains values of 0 or 1. If 1, the corresponding channel has a longer settling time. This is useful when using a high gain such as 100 or 1000.

**Range** — Select the voltage range from the list provided. This applies to all channels.

**Sample time** — Enter the base sample time or a multiple of the base sample time.

**PCI Slot (-1:autosearch)** — If only one board of this type is physically present in the target PC, enter

-1

to automatically locate the board.

If two or more boards of this type are physically present in the target PC, enter the bus number and the PCI slot number of the board associated with this driver block. Use the format [BusNumber, SlotNumber]. To determine the bus number and the PCI slot number, type

```
getxpcpci
```

## PD2-MF 16-Bit Series Frame Analog Input

### Scaling Input to Output

| Hardware Input | Block Output Data Type | Scaling |
|----------------|------------------------|---------|
| volts          | Double                 | 1       |

### Driver Block Parameters

**Board type** — Select the specific board type from the list provided.

**Channel vector** — Enter a vector of numbers that make up one scan. For example, to read the first and fifth channels, enter

```
[1 5]
```

The channel numbers can occur in any order. Number the channels beginning with 1 even though the board manufacturer numbers them beginning with 0. The maximum allowable channel number is 4, 8, 16, or 64 depending on the board type.

**Gain vector** — Enter a vector of numbers to specify the gains for each of the channels in the scan. Enter a single value to use the same gain for all vectors in the scan. Available gains vary depending on board type. Allowable values depend on the board type.

- L (Low level) boards — Specify the gain as one of 1, 10, 100, or 1000.
- H (High level) boards — Specify the gain as one of 1, 2, 4, or 8.
- DG-option boards — Specify the gain as one of 1, 2, 5, or 10.

**Mux settling time vector (slow bit)** — Enter a vector that is the same length as the channel vector. Each vector element must be a 0 or 1. If you specify 1, the corresponding channel has a longer settling time. To get an accurate reading, you might want to specify a 1 for channels that have higher gains, such as 100 or 1000. Refer to the UEI PowerDAQ documentation for further information on the longer settling time. This time depends on the board type.

---

**Caution** With frame based acquisition, the additional time needed for the **Mux settling time vector (slow bit)** value might cause an acquisition overrun that xPC Target does not detect. For example, on a PD2-MF-xx-333/16H board, each nonslow acquisition takes 3 microseconds. If the slow bit is set to 1, that same acquisition takes more than 10 microseconds. With xPC Target, the scan is performed at the maximum rate for a given board. This means that the slow acquisition takes a multiple of 3 microsecond ticks. For a PD2-MF-xx-333/16H board, this becomes 12 microseconds.

For example, assume that  $N$  scans of the channel vector compose a frame of data. Assume also that you have a PD2-MF-xx-333/16H board with a **Channel vector** value of [1 2 3 4] and a **Mux settling time vector (slow bit)** value of [0 1 0 1]. For the PD2-MF-xx-333/16H board, two of the of the acquisition delays are 3 microseconds, and two are 12 microseconds. With a **Block sampletime** value of .001 second, if  $N$  is greater than 38, the data will not be acceptable. If you set all slow bits to 0,  $N$  can have a value of up to 83. The software detects the limit at  $N = 83$ , but is not aware of the extra board dependent delay.

---

**Range** — From the list, select one of the following voltage ranges. The value you select applies to all channels.

- +-10 Volts
- +-5 Volts
- 0-10 Volts
- 0-5 Volts

**Input coupling mode** — From the list, select one from the following list of input coupling modes:

- Single Ended
- Differential

Refer to the UEI PowerDAQ documentation for input connections.

**Frame size** — Enter the number of samples per channel to return as a frame of data. Due to constraints in the hardware architecture, the total number of samples in a frame of data cannot exceed 512. The relationship between the number of samples, frame size, and number of channels is

$$\text{total number of samples} = \text{FrameSize} \times \text{nChannels}$$

For example, if you specify two channels, the frame size must be less than or equal to 256.

**Output format** — From the list, select either Frame or Vector.

- Frame — Select Frame if you expect the output signal from this block to be the input signal for a block that requires a frame. For example, a Signal Processing block.
- Vector — Select Vector if you expect the output signal from this block to be the input signal for an xPC Target scope or some other block that requires vector input.

**Scan clock source** — Select Internal or External to identify the clock source for the frame scans.

**Scan time** — Enter the time (in seconds) between scans as the interval.

**Frame time** — Enter the interval (in seconds) during which the board will interrupt. The driver block evenly spaces the scans in the frame across the **Frame time** interval. If the **Frame time** interval is too short, you will receive a buffer overrun error at run time. For optimal results, experimentally increase the **Frame time** value and reiterate the process. Always rebuild the model when you change this value.

The **Frame size**, **Scan time**, and **Frame time** parameters are not independent, but are related by

$$\text{Frametime} = \text{Framesize} \times \text{Scantime}$$

After you specify two of the parameters, specify -1 for the third parameter and the equation determines the third parameter.

---

**Note** Because xPC Target uses this value to set hardware parameters on the board, you cannot change the **Frame time** value at the MATLAB prompt.

---

**Block is in an ISR** — Select this check box if the block is in an interrupt service routine (ISR). Selecting this check box forces the block sample time to -1, which enables the block to work in the ISR. If this check box is not selected, the block sample time is equal to the value of **Frame time**.

**Slave board** — If you have multiple boards configured in a master/slave combination, select this box for the slave boards only. Leave the box unchecked for the master board. (Note that a single board configuration is considered a master board.)

---

**Note** In the model, set the priority of slave blocks higher than master blocks. Right-click the slave or master block and select **Block Properties**. In the dialog, enter a value in the **Priority** property. For example, if you have multiple slave blocks, you can enter values of 2 for the slave blocks and 3 for the master block, where a lower number indicates a higher priority.

---

**Acquisition frequency** — Enter the rate at which the high speed conversion clock runs. This is the clock used to acquire each scan in a frame. For example, with a PD2-MF-xx-333/16H board, the maximum clock is 333 kHz. At that rate, the second channel in a scan will be acquired 3 microseconds after the first one in every scan of the frame.

Specify -1 to select the maximum rate available for the specified board.

**DMA burst size** — From the list, select either 32, 16, or 8. The DMA engine transfers data in packets of the burst size or less. Between each burst, a new bus arbitration cycle must complete. The best performance is achieved with higher **DMA burst size** values, with 32 being highest. However, in some architectures and with some PCI bus adaptors, a **DMA burst size** of 32 might cause problems. For example, it might lock up the target machine when DMA is attempted. In these cases, reduce the **DMA burst size** value to 8, rebuild and rerun the target application. If the DMA works at 8, select 16 to increase performance and try again.

**PCI Slot (-1:autosearch)** — If only one board of this type is physically present in the target PC, enter

-1

to automatically locate the board.

If two or more boards of this type are physically present in the target PC, enter the bus number and the PCI slot number of the board associated with this driver block. Use the format [BusNumber, SlotNumber]. To determine the bus number and the PCI slot number, type

```
getxpcpci
```

## PD2-MF 16-Bit Series Analog Output (D/A)

### Scaling Input to Output

| Hardware Output | Block Input Data Type | Scaling |
|-----------------|-----------------------|---------|
| volts           | Double                | 1       |

### Driver Block Parameters

**Board type** — Select the specific board type from the list provided.

**Channel vector** — Enter a vector of numbers to specify the output channels 1 or 2. For example, to use the first and second analog output (D/A) channels, enter

```
[1 2]
```

The channel numbers can occur in any order. Number the channels beginning with 1 even if the board manufacturer numbers them beginning with 0.

**Reset vector** — The reset vector must be the same length as the channel vector. It contains values of 0 or 1. This parameter controls the behavior at model termination. A value of 1 causes the corresponding channel to be reset to the value specified in the initial value vector. A value of 0 causes the channel to remain at the last value attained while the model was running.

**Initial value vector** — The initial value vector must be the same length as the channel vector and should contain the initial voltage values for the output

channels. The channels are set to these values between the time the model is downloaded and the time it is started.

**Sample time** — Enter the base sample time or a multiple of the base sample time.

**PCI Slot (-1:autosearch)** — If only one board of this type is physically present in the target PC, enter

-1

to automatically locate the board.

If two or more boards of this type are physically present in the target PC, enter the bus number and the PCI slot number of the board associated with this driver block. Use the format [BusNumber, SlotNumber]. To determine the bus number and the PCI slot number, type

getxpcpci

## PD2-MF 16-Bit Series Digital Input

### Scaling Input to Output

| Hardware Input | Block Output Data Type | Scaling                         |
|----------------|------------------------|---------------------------------|
| TTL            | Double                 | TTL low = 0.0<br>TTL high = 1.0 |

### Driver Block Parameters

**Board type** — Select the specific board type from the list provided.

**Channel vector** — Enter a vector of numbers to specify the input channels. For example, to use the first and third digital input channels, enter

[1 3]

The channel numbers can occur in any order. Number the channels beginning with 1 even if the board manufacturer numbers them beginning with 0. The maximum allowable channel number is 16 for all boards except for the PD2-AO and PDXI-AO series. For those boards, the maximum channel number is 8.



**Sample time** — Enter the base sample time or a multiple of the base sample time.

**PCI Slot (-1:autosearch)** — If only one board of this type is physically present in the target PC, enter

-1

to automatically locate the board.

If two or more boards of this type are physically present in the target PC, enter the bus number and the PCI slot number of the board associated with this driver block. Use the format [BusNumber, SlotNumber]. To determine the bus number and the PCI slot number, type

```
getxpcpci
```

## PD2-MF 16-Bit Series Digital Output

### Scaling Input to Output

| Hardware Output | Block Input Data Type | Scaling                             |
|-----------------|-----------------------|-------------------------------------|
| TTL             | Double                | < 0.5 = TTL low<br>> 0.5 = TTL high |

### Driver Block Parameters

**Board type** — Select the specific board type from the list provided.

**Channel vector** — Enter a vector of numbers to specify the output channels. For example, to use the first and third digital output channels, enter

```
[1 3]
```

The channel numbers can occur in any order. Number the channels beginning with 1 even if the board manufacturer numbers them beginning with 0. The maximum allowable channel number is 16 for all board types except for the PD2-AO and PDXI-AO series. For those boards, the maximum channel number is 8.

**Reset vector** — The reset vector must be the same length as the channel vector. It contains values of 0 or 1. This parameter controls the behavior at model termination. A value of 1 causes the corresponding channel to be reset to the value specified in the initial value vector. A value of 0 causes the channel to remain at the last value attained while the model was running.

**Initial value vector** — The initial value vector must be the same length as the channel vector. It contains the initial values (0 or 1) for the output channels. The channels are set to these values between the time the model is downloaded and the time it is started.

**Sample time** — Enter the base sample time or a multiple of the base sample time.

**PCI Slot (-1:autosearch)** — If only one board of this type is physically present in the target PC, enter

-1

to automatically locate the board.

If two or more boards of this type are physically present in the target PC, enter the bus number and the PCI slot number of the board associated with this driver block. Use the format [BusNumber, SlotNumber]. To determine the bus number and the PCI slot number, type

```
getxpcpci
```

## PD2-MFS 12-Bit Series

The PD2-MFS 12-bit series contains I/O boards with 4 or 8 single analog input (A/D) channels (12-bit). The boards also have 2 analog output (D/A) channels (12-bit), 16 digital input, and 16 digital output lines. xPC Target does not support the counter/timers on these boards.

xPC Target supports this series of boards with these driver blocks:

- “PD2-MFS 12-Bit Series Analog Input (A/D)” on page 30-44
- “PD2-MFS 12-Bit Series Frame Analog Input” on page 30-45
- “PD2-MFS 12-Bit Series Analog Output (D/A)” on page 30-49
- “PD2-MFS 12-Bit Series Digital Input” on page 30-50
- “PD2-MFS 12-Bit Series Digital Output” on page 30-51

### Board Characteristics

|                                 |                                                                              |
|---------------------------------|------------------------------------------------------------------------------|
| Board type                      | PD2-MFS-4-1M/12<br>PD2-MFS-4-1M/12DG<br>PD2-MFS-8-1M/12<br>PD2-MFS-8-1M/12DG |
| Manufacturer                    | United Electronic Industries (UEI)                                           |
| Bus type                        | PCI, ISA                                                                     |
| Access method                   | Memory mapped                                                                |
| Multiple block instance support | No                                                                           |
| Multiple board support          | Yes                                                                          |

## PD2-MFS 12-Bit Series Analog Input (A/D)

### Scaling Input to Output

| Hardware Input | Block Output Data Type | Scaling |
|----------------|------------------------|---------|
| volts          | Double                 | 1       |

### Driver Block Parameters

**Board type** — Select the specific board type from the list provided.

**Channel vector** — Enter a vector of numbers to specify the input channels. For example, use the first and third analog input (A/D) channels, enter

[1 3]

The channel numbers can occur in any order. Number the channels beginning with 1 even if the board manufacturer numbers them beginning with 0. The maximum allowable channel number is 4, 8, 16, or 64 depending on the board type.

**Gain vector** — Enter a vector of numbers to select the gains for each of the channels. Available gains vary depending on board type. MF PGL gains may be set to 1, 10, 100, or 1000. MF PGH gains may be set to 1, 2, 4, or 8. MF DG-option gains may be set to 1, 2, 5, or 10.

**Mux settling time factor** — This vector must be the same length as the channel vector. It contains values of 0 or 1. If 1, the corresponding channel has a longer settling time. This is useful when using a high gain such as 100 or 1000.

**Range** — Select the voltage range from the list provided. This applies to all channels.

**Sample time** — Enter the base sample time or a multiple of the base sample time.

**PCI Slot (-1:autosearch)** — If only one board of this type is physically present in the target PC, enter

-1

to automatically locate the board.

If two or more boards of this type are physically present in the target PC, enter the bus number and the PCI slot number of the board associated with this driver block. Use the format [BusNumber, SlotNumber]. To determine the bus number and the PCI slot number, type

```
getxpcpci
```

## PD2-MFS 12-Bit Series Frame Analog Input

### Scaling Input to Output

| Hardware Input | Block Output Data Type | Scaling |
|----------------|------------------------|---------|
| volts          | Double                 | 1       |

### Driver Block Parameters

**Board type** — Select the specific board type from the list provided.

**Channel vector** — Enter a vector of numbers that make up one scan. For example, to read the first and fifth channels, enter

```
[1 5]
```

The channel numbers can occur in any order. Number the channels beginning with 1 even though the board manufacturer numbers them beginning with 0. The maximum allowable channel number is 4, 8, 16, or 64 depending on the board type.

**Gain vector** — Enter a vector of numbers to specify the gains for each of the channels in the scan. Enter a single value to use the same gain for all vectors in the scan. Available gains vary depending on board type. Allowable values depend on the board type:

- L (Low level) boards — Specify the gain as one of 1, 10, 100, or 1000.
- H (High level) boards — Specify the gain as one of 1, 2, 4, or 8.
- DG-option boards — Specify the gain as one of 1, 2, 5, or 10.

**Mux settling time vector (slow bit)** — Enter a vector that is the same length as the channel vector. Each vector element must be a 0 or 1. If you specify 1, the corresponding channel has a longer settling time. To get an accurate

reading, you might want to specify a 1 for channels that have higher gains, such as 100 or 1000. Refer to the UEI PowerDAQ documentation for further information on the longer settling time. This time depends on the board type.

---

**Caution** With frame based acquisition, the additional time needed for the **Mux settling time vector (slow bit)** value might cause an acquisition overrun that xPC Target does not detect. For example, on a PD2-MF-xx-333/16H board, each nonslow acquisition takes 3 microseconds. If the slow bit is set to 1, that same acquisition takes more than 10 microseconds. With xPC Target, the scan is performed at the maximum rate for a given board. This means that the slow acquisition takes a multiple of 3 microsecond ticks. For a PD2-MF-xx-333/16H board, this becomes 12 microseconds.

For example, assume that  $N$  scans of the channel vector compose a frame of data. Assume also that you have a PD2-MF-xx-333/16H board with a **Channel vector** value of [1 2 3 4] and a **Mux settling time vector (slow bit)** value of [0 1 0 1]. For the PD2-MF-xx-333/16H board, two of the of the acquisition delays are 3 microseconds, and two are 12 microseconds. With a **Block sampletime** value of .001 second, if  $N$  is greater than 38, the data will not be acceptable. If you set all slow bits to 0,  $N$  can have a value of up to 83. The software detects the limit at  $N = 83$ , but is not aware of the extra board dependent delay.

---

**Range** — From the list, select one of the following voltage ranges. The value you select applies to all channels.

- +-10 Volts
- +-5 Volts
- 0-10 Volts
- 0-5 Volts

**Frame size** — Enter the number of samples per channel to return as a frame of data. Due to constraints in the hardware architecture, the total number of samples in a frame of data cannot exceed 1024. The relationship between the number of samples, frame size, and number of channels is

$$\text{total number of samples} = \text{FrameSize} \times \text{nChannels}$$

For example, if you specify two channels, the frame size must be less than or equal to 512.

**Output format** — From the list, select either Frame or Vector.

- **Frame** — Select Frame if you expect the output signal from this block to be the input signal for a block that requires a frame. For example, a Signal Processing block.
- **Vector** — Select Vector if you expect the output signal from this block to be the input signal for an xPC Target scope or some other block that requires vector input.

**Scan clock source** — Select Internal or External to identify the clock source for the frame scans.

**Scan time** — Enter the time (in seconds) between scans as the interval.

**Frame time** — Enter the interval (in seconds) during which the board will interrupt. The driver block evenly spaces the scans in the frame across the **Frame time** interval. If the **Frame time** interval is too short, you will receive a buffer overrun error at run time. For optimal results, experimentally increase the **Frame time** value and reiterate the process. Always rebuild the model when you change this value.

The **Frame size**, **Scan time**, and **Frame time** parameters are not independent, but are related by

$$\text{Frame time} = \text{Framesize} \times \text{Scantime}$$

After you specify two of the parameters, specify -1 for the third parameter and the equation determines the third parameter.

---

**Note** Because xPC Target uses this value to set hardware parameters on the board, you cannot change the **Frame time** value at the MATLAB prompt.

---

**Block is in an ISR** — Select this check box if the block is in an interrupt service routine (ISR). Selecting this check box forces the block sample time to -1, which enables the block to work in the ISR. If this check box is not selected, the block sample time is equal to the value of **Frame time**.

**Slave board** — If you have multiple boards configured in a master/slave combination, select this box for the slave boards only. Leave the box unchecked for the master board. (Note that a single board configuration is considered a master board.)

---

**Note** In the model, set the priority of slave blocks higher than master blocks. Right-click the slave or master block and select **Block Properties**. In the dialog, enter a value in the **Priority** property. For example, if you have multiple slave blocks, you can enter values of 2 for the slave blocks and 3 for the master block, where a lower number indicates a higher priority.

---

**Acquisition frequency** — Enter the rate at which the high speed conversion clock runs. This is the clock used to acquire each scan in a frame. For example, with a PD2-MF-xx-333/16H board, the maximum clock is 333 kHz. At that rate, the second channel in a scan will be acquired 3 microseconds after the first one in every scan of the frame.

Specify -1 to select the maximum rate available for the specified board.

**DMA burst size** — From the list, select either 32, 16, or 8. The DMA engine transfers data in packets of the burst size or less. Between each burst, a new bus arbitration cycle must complete. The best performance is achieved with higher **DMA burst size** values, with 32 being highest. However, in some architectures and with some PCI bus adaptors, a **DMA burst size** of 32 might cause problems. For example, it might lock up the target machine when DMA is attempted. In these cases, reduce the **DMA burst size** value to 8, rebuild and rerun the target application. If the DMA works at 8, select 16 to increase performance and try again.

**PCI Slot (-1:autosearch)** — If only one board of this type is physically present in the target PC, enter

-1

to automatically locate the board.

If two or more boards of this type are physically present in the target PC, enter the bus number and the PCI slot number of the board associated with this driver block. Use the format [BusNumber, SlotNumber]. To determine the bus number and the PCI slot number, type



getxpcpci

## PD2-MFS 12-Bit Series Analog Output (D/A)

### Scaling Input to Output

| Hardware Output | Block Input Data Type | Scaling |
|-----------------|-----------------------|---------|
| volts           | Double                | 1       |

### Driver Block Parameters

**Board type** — Select the specific board type from the list provided.

**Channel vector** — Enter a vector of numbers to specify the output channels 1 or 2. For example, to use the first and second analog output (D/A) channels, enter

[1 2]

The channel numbers can occur in any order. Number the channels beginning with 1 even if the board manufacturer numbers them beginning with 0.

**Reset vector** — The reset vector must be the same length as the channel vector. It contains values of 0 or 1. This parameter controls the behavior at model termination. A value of 1 causes the corresponding channel to be reset to the value specified in the initial value vector. A value of 0 causes the channel to remain at the last value attained while the model was running.

**Initial value vector** — The initial value vector must be the same length as the channel vector and should contain the initial voltage values for the output channels. The channels are set to these values between the time the model is downloaded and the time it is started.

**Sample time** — Enter the base sample time or a multiple of the base sample time.

**PCI Slot (-1:autosearch)** — If only one board of this type is physically present in the target PC, enter

-1

to automatically locate the board.

If two or more boards of this type are physically present in the target PC, enter the bus number and the PCI slot number of the board associated with this driver block. Use the format [BusNumber, SlotNumber]. To determine the bus number and the PCI slot number, type

```
getxpcpci
```

## PD2-MFS 12-Bit Series Digital Input

### Scaling Input to Output

| Hardware Input | Block Output Data Type | Scaling                         |
|----------------|------------------------|---------------------------------|
| TTL            | Double                 | TTL low = 0.0<br>TTL high = 1.0 |

### Driver Block Parameters

**Board type** — Select the specific board type from the list provided.

**Channel vector** — Enter a vector of numbers to specify the input channels. For example, to use the first and third digital input channels, enter

```
[1 3]
```

The channel numbers can occur in any order. Number the channels beginning with 1 even if the board manufacturer numbers them beginning with 0. The maximum allowable channel number is 16 for all boards except for the PD2-AO and PDXI-AO series. For those boards, the maximum channel number is 8.

**Sample time** — Enter the base sample time or a multiple of the base sample time.

**PCI Slot (-1:autosearch)** — If only one board of this type is physically present in the target PC, enter

```
-1
```

to automatically locate the board.

If two or more boards of this type are physically present in the target PC, enter the bus number and the PCI slot number of the board associated with this driver block. Use the format [BusNumber, SlotNumber]. To determine the bus number and the PCI slot number, type

```
getxpcpci
```

## PD2-MFS 12-Bit Series Digital Output

### Scaling Input to Output

| Hardware Output | Block Input Data Type | Scaling                             |
|-----------------|-----------------------|-------------------------------------|
| TTL             | Double                | < 0.5 = TTL low<br>> 0.5 = TTL high |

### Driver Block Parameters

**Board type** — Select the specific board type from the list provided.

**Channel vector** — Enter a vector of numbers to specify the output channels. For example, to use the first and third digital output channels, enter

```
[1 3]
```

The channel numbers can occur in any order. Number the channels beginning with 1 even if the board manufacturer numbers them beginning with 0. The maximum allowable channel number is 16 for all board types except for the PD2-AO and PDXI-AO series. For those boards, the maximum channel number is 8.

**Reset vector** — The reset vector must be the same length as the channel vector. It contains values of 0 or 1. This parameter controls the behavior at model termination. A value of 1 causes the corresponding channel to be reset to the value specified in the initial value vector. A value of 0 causes the channel to remain at the last value attained while the model was running.

**Initial value vector** — The initial value vector must be the same length as the channel vector. It contains the initial values (0 or 1) for the output channels. The channels are set to these values between the time the model is downloaded and the time it is started.

**Sample time** — Enter the base sample time or a multiple of the base sample time.

**PCI Slot (-1:autosearch)** — If only one board of this type is physically present in the target PC, enter

-1

to automatically locate the board.

If two or more boards of this type are physically present in the target PC, enter the bus number and the PCI slot number of the board associated with this driver block. Use the format [BusNumber, SlotNumber]. To determine the bus number and the PCI slot number, type

```
getxpcpci
```

## PD2-MFS 14-Bit Series

The PD2-MFS 14-bit series contains I/O boards with 4 or 8 single analog input (A/D) channels (14-bit). The boards also have 2 analog output (D/A) channels (12-bit), 16 digital input, and 16 digital output lines. xPC Target does not support the counter/timers on these boards.

xPC Target supports this series of boards with these driver blocks:

- “PD2-MFS 14-Bit Series Analog Input (A/D)” on page 30-54
- “PD2-MFS 14-Bit Series Frame Analog Input” on page 30-55
- “PD2-MFS 14-Bit Series Analog Output (D/A)” on page 30-59
- “PD2-MFS 14-Bit Series Digital Input” on page 30-60
- “PD2-MFS 14-Bit Series Digital Output” on page 30-61

### Board Characteristics

|                                 |                                                                                                                                                                                                                                                      |
|---------------------------------|------------------------------------------------------------------------------------------------------------------------------------------------------------------------------------------------------------------------------------------------------|
| Board type                      | PD2-MFS-4-500/14<br>PD2-MFS-4-500/14DG<br>PD2-MFS-8-500/14<br>PD2-MFS-8-500/14DG<br>PD2-MFS-4-800/14<br>PD2-MFS-4-800/14DG<br>PD2-MFS-8-800/14<br>PD2-MFS-8-800/14DG<br>PD2-MFS-4-2M/14<br>PD2-MFS-4-2M/14DG<br>PD2-MFS-8-2M/14<br>PD2-MFS-8-2M/14DG |
| Manufacturer                    | United Electronic Industries (UEI)                                                                                                                                                                                                                   |
| Bus type                        | PCI, ISA                                                                                                                                                                                                                                             |
| Access method                   | Memory mapped                                                                                                                                                                                                                                        |
| Multiple block instance support | No                                                                                                                                                                                                                                                   |
| Multiple board support          | Yes                                                                                                                                                                                                                                                  |

## PD2-MFS 14-Bit Series Analog Input (A/D)

### Scaling Input to Output

| Hardware Input | Block Output Data Type | Scaling |
|----------------|------------------------|---------|
| volts          | Double                 | 1       |

### Driver Block Parameters

**Board type** — Select the specific board type from the list provided.

**Channel vector** — Enter a vector of numbers to specify the input channels. For example, use the first and third analog input (A/D) channels, enter

[1 3]

The channel numbers can occur in any order. Number the channels beginning with 1 even if the board manufacturer numbers them beginning with 0. The maximum allowable channel number is 4, 8, 16, or 64 depending on the board type.

**Gain vector** — Enter a vector of numbers to select the gains for each of the channels. Available gains vary depending on board type. MF PGL gains may be set to 1, 10, 100, or 1000. MF PGH gains may be set to 1, 2, 4, or 8. MF DG-option gains may be set to 1, 2, 5, or 10.

**Mux settling time factor** — This vector must be the same length as the channel vector. It contains values of 0 or 1. If 1, the corresponding channel has a longer settling time. This is useful when using a high gain such as 100 or 1000.

**Range** — Select the voltage range from the list provided. This applies to all channels.

**Sample time** — Enter the base sample time or a multiple of the base sample time.

**PCI Slot (-1:autosearch)** — If only one board of this type is physically present in the target PC, enter

-1

to automatically locate the board.

If two or more boards of this type are physically present in the target PC, enter the bus number and the PCI slot number of the board associated with this driver block. Use the format [BusNumber, SlotNumber]. To determine the bus number and the PCI slot number, type

```
getxpcpci
```

## PD2-MFS 14-Bit Series Frame Analog Input

### Scaling Input to Output

| Hardware Input | Block Output Data Type | Scaling |
|----------------|------------------------|---------|
| volts          | Double                 | 1       |

### Driver Block Parameters

**Board type** — Select the specific board type from the list provided.

**Channel vector** — Enter a vector of numbers that make up one scan. For example, to read the first and fifth channels, enter

```
[1 5]
```

The channel numbers can occur in any order. Number the channels beginning with 1 even though the board manufacturer numbers them beginning with 0. The maximum allowable channel number is 4, 8, 16, or 64 depending on the board type.

**Gain vector** — Enter a vector of numbers to specify the gains for each of the channels in the scan. Enter a single value to use the same gain for all vectors in the scan. Available gains vary depending on board type. Allowable values depend on the board type.

- L (Low level) boards — Specify the gain as one of 1, 10, 100, or 1000.
- H (High level) boards — Specify the gain as one of 1, 2, 4, or 8.
- DG-option boards — Specify the gain as one of 1, 2, 5, or 10.

**Mux settling time vector (slow bit)** — Enter a vector that is the same length as the channel vector. Each vector element must be a 0 or 1. If you specify 1, the corresponding channel has a longer settling time. To get an accurate reading, you might want to specify a 1 for channels that have higher gains, such as 100 or 1000. Refer to the UEI PowerDAQ documentation for further information on the longer settling time. This time depends on the board type.

---

**Caution** With frame based acquisition, the additional time needed for the **Mux settling time vector (slow bit)** value might cause an acquisition overrun that xPC Target does not detect. For example, on a PD2-MF-xx-333/16H board, each nonslow acquisition takes 3 microseconds. If the slow bit is set to 1, that same acquisition takes more than 10 microseconds. With xPC Target, the scan is performed at the maximum rate for a given board. This means that the slow acquisition takes a multiple of 3 microsecond ticks. For a PD2-MF-xx-333/16H board, this becomes 12 microseconds.

For example, assume that  $N$  scans of the channel vector compose a frame of data. Assume also that you have a PD2-MF-xx-333/16H board with a **Channel vector** value of [1 2 3 4] and a **Mux settling time vector (slow bit)** value of [0 1 0 1]. For the PD2-MF-xx-333/16H board, two of the of the acquisition delays are 3 microseconds, and two are 12 microseconds. With a **Block sampletime** value of .001 second, if  $N$  is greater than 38, the data will not be acceptable. If you set all slow bits to 0,  $N$  can have a value of up to 83. The software detects the limit at  $N = 83$ , but is not aware of the extra board dependent delay.

---

**Range** — From the list, select one of the following voltage ranges. The value you select applies to all channels.

- +-10 Volts
- +-5 Volts
- 0-10 Volts
- 0-5 Volts



**Frame size** — Enter the number of samples per channel to return as a frame of data. Due to constraints in the hardware architecture, the total number of samples in a frame of data cannot exceed 1024. The relationship between the number of samples, frame size, and number of channels is

$$\text{total number of samples} = \text{FrameSize} \times \text{nChannels}$$

For example, if you specify two channels, the frame size must be less than or equal to 512.

**Output format** — From the list, select either Frame or Vector.

- **Frame** — Select Frame if you expect the output signal from this block to be the input signal for a block that requires a frame. For example, a Signal Processing block.
- **Vector** — Select Vector if you expect the output signal from this block to be the input signal for an xPC Target scope or some other block that requires vector input.

**Scan clock source** — Select Internal or External to identify the clock source for the frame scans.

**Scan time** — Enter the time (in seconds) between scans as the interval.

**Frame time** — Enter the interval (in seconds) during which the board will interrupt. The driver block evenly spaces the scans in the frame across the **Frame time** interval. If the **Frame time** interval is too short, you will receive a buffer overrun error at run time. For optimal results, experimentally increase the **Frame time** value and reiterate the process. Always rebuild the model when you change this value.

The **Frame size**, **Scan time**, and **Frame time** parameters are not independent, but are related by

$$\text{Frametime} = \text{Framesize} \times \text{Scantime}$$

After you specify two of the parameters, specify -1 for the third parameter and the equation determines the third parameter.

---

**Note** Because xPC Target uses this value to set hardware parameters on the board, you cannot change the **Frame time** value at the MATLAB prompt.

---

**Block is in an ISR** — Select this check box if the block is in an interrupt service routine (ISR). Selecting this check box forces the block sample time to -1, which enables the block to work in the ISR. If this check box is not selected, the block sample time is equal to the value of **Frame time**.

**Slave board** — If you have multiple boards configured in a master/slave combination, select this box for the slave boards only. Leave the box unchecked for the master board. (Note that a single board configuration is considered a master board.)

---

**Note** In the model, set the priority of slave blocks higher than master blocks. Right-click the slave or master block and select **Block Properties**. In the dialog, enter a value in the **Priority** property. For example, if you have multiple slave blocks, you can enter values of 2 for the slave blocks and 3 for the master block, where a lower number indicates a higher priority.

---

**Acquisition frequency** — Enter the rate at which the high speed conversion clock runs. This is the clock used to acquire each scan in a frame. For example, with a PD2-MF-xx-333/16H board, the maximum clock is 333 kHz. At that rate, the second channel in a scan will be acquired 3 microseconds after the first one in every scan of the frame.

Specify -1 to select the maximum rate available for the specified board.

**DMA burst size** — From the list, select either 32, 16, or 8. The DMA engine transfers data in packets of the burst size or less. Between each burst, a new bus arbitration cycle must complete. The best performance is achieved with higher **DMA burst size** values, with 32 being highest. However, in some architectures and with some PCI bus adaptors, a **DMA burst size** of 32 might cause problems. For example, it might lock up the target machine when DMA is attempted. In these cases, reduce the **DMA burst size** value to 8, rebuild and rerun the target application. If the DMA works at 8, select 16 to increase performance and try again.

**PCI Slot (-1:autosearch)** — If only one board of this type is physically present in the target PC, enter

-1

to automatically locate the board.

If two or more boards of this type are physically present in the target PC, enter the bus number and the PCI slot number of the board associated with this driver block. Use the format [BusNumber, SlotNumber]. To determine the bus number and the PCI slot number, type

```
getxpcpci
```

## PD2-MFS 14-Bit Series Analog Output (D/A)

### Scaling Input to Output

| Hardware Output | Block Input Data Type | Scaling |
|-----------------|-----------------------|---------|
| volts           | Double                | 1       |

### Driver Block Parameters

**Board type** — Select the specific board type from the list provided.

**Channel vector** — Enter a vector of numbers to specify the output channels 1 or 2. For example, to use the first and second analog output (D/A) channels, enter

```
[1 2]
```

The channel numbers can occur in any order. Number the channels beginning with 1 even if the board manufacturer numbers them beginning with 0.

**Reset vector** — The reset vector must be the same length as the channel vector. It contains values of 0 or 1. This parameter controls the behavior at model termination. A value of 1 causes the corresponding channel to be reset to the value specified in the initial value vector. A value of 0 causes the channel to remain at the last value attained while the model was running.

**Initial value vector** — The initial value vector must be the same length as the channel vector and should contain the initial voltage values for the output channels. The channels are set to these values between the time the model is downloaded and the time it is started.

**Sample time** — Enter the base sample time or a multiple of the base sample time.

**PCI Slot (-1:autosearch)** — If only one board of this type is physically present in the target PC, enter

-1

to automatically locate the board.

If two or more boards of this type are physically present in the target PC, enter the bus number and the PCI slot number of the board associated with this driver block. Use the format [BusNumber, SlotNumber]. To determine the bus number and the PCI slot number, type

getxpcpci

## PD2-MFS 14-Bit Series Digital Input

### Scaling Input to Output

| Hardware Input | Block Output Data Type | Scaling                         |
|----------------|------------------------|---------------------------------|
| TTL            | Double                 | TTL low = 0.0<br>TTL high = 1.0 |

### Driver Block Parameters

**Board type** — Select the specific board type from the list provided.

**Channel vector** — Enter a vector of numbers to specify the input channels. For example, to use the first and third digital input channels, enter

[1 3]

The channel numbers can occur in any order. Number the channels beginning with 1 even if the board manufacturer numbers them beginning with 0. The maximum allowable channel number is 16 for all boards except for the PD2-AO and PDXI-AO series. For those boards, the maximum channel number is 8.

**Sample time** — Enter the base sample time or a multiple of the base sample time.

**PCI Slot (-1:autosearch)** — If only one board of this type is physically present in the target PC, enter

-1

to automatically locate the board.

If two or more boards of this type are physically present in the target PC, enter the bus number and the PCI slot number of the board associated with this driver block. Use the format [BusNumber, SlotNumber]. To determine the bus number and the PCI slot number, type

```
getxpcpci
```

## PD2-MFS 14-Bit Series Digital Output

### Scaling Input to Output

| Hardware Output | Block Input Data Type | Scaling                             |
|-----------------|-----------------------|-------------------------------------|
| TTL             | Double                | < 0.5 = TTL low<br>> 0.5 = TTL high |

### Driver Block Parameters

**Board type** — Select the specific board type from the list provided.

**Channel vector** — Enter a vector of numbers to specify the output channels. For example, to use the first and third digital output channels, enter

```
[1 3]
```

The channel numbers can occur in any order. Number the channels beginning with 1 even if the board manufacturer numbers them beginning with 0. The maximum allowable channel number is 16 for all board types except for the PD2-AO and PDXI-AO series. For those boards, the maximum channel number is 8.

**Reset vector** — The reset vector must be the same length as the channel vector. It contains values of 0 or 1. This parameter controls the behavior at model termination. A value of 1 causes the corresponding channel to be reset

to the value specified in the initial value vector. A value of 0 causes the channel to remain at the last value attained while the model was running.

**Initial value vector** — The initial value vector must be the same length as the channel vector. It contains the initial values (0 or 1) for the output channels. The channels are set to these values between the time the model is downloaded and the time it is started.

**Sample time** — Enter the base sample time or a multiple of the base sample time.

**PCI Slot (-1:autosearch)** — If only one board of this type is physically present in the target PC, enter

- 1

to automatically locate the board.

If two or more boards of this type are physically present in the target PC, enter the bus number and the PCI slot number of the board associated with this driver block. Use the format [BusNumber, SlotNumber]. To determine the bus number and the PCI slot number, type

getxpcpci

## PD2-MFS 16-Bit Series

The PD2-MFS 16-bit series contains I/O boards with 4 or 8 single analog input (A/D) channels (16-bit). The boards also have 2 analog output (D/A) channels (12-bit), 16 digital input, and 16 digital output lines. xPC Target does not support the counter/timers on these boards.

xPC Target supports this series of boards with these driver blocks:

- “PD2-MFS 16-Bit Series Analog Input (A/D)” on page 30-64
- “PD2-MFS 16-Bit Series Frame Analog Input” on page 30-65
- “PD2-MFS 16-Bit Series Analog Output (D/A)” on page 30-69
- “PD2-MFS 16-Bit Series Digital Input” on page 30-70
- “PD2-MFS 16-Bit Series Digital Output” on page 30-71

### Board Characteristics

|                                 |                                                                                                                                                                      |
|---------------------------------|----------------------------------------------------------------------------------------------------------------------------------------------------------------------|
| Board type                      | PD2-MFS-4-300/16<br>PD2-MFS-4-300/16DG<br>PD2-MFS-8-300/16<br>PD2-MFS-8-300/16DG<br>PD2-MFS-4-500/16<br>PD2-MFS-4-500/16DG<br>PD2-MFS-8-500/16<br>PD2-MFS-8-500/16DG |
| Manufacturer                    | United Electronic Industries (UEI)                                                                                                                                   |
| Bus type                        | PCI, ISA                                                                                                                                                             |
| Access method                   | Memory mapped                                                                                                                                                        |
| Multiple block instance support | No                                                                                                                                                                   |
| Multiple board support          | Yes                                                                                                                                                                  |

## PD2-MFS 16-Bit Series Analog Input (A/D)

### Scaling Input to Output

| Hardware Input | Block Output Data Type | Scaling |
|----------------|------------------------|---------|
| volts          | Double                 | 1       |

### Driver Block Parameters

**Board type** — Select the specific board type from the list provided.

**Channel vector** — Enter a vector of numbers to specify the input channels. For example, use the first and third analog input (A/D) channels, enter

[1 3]

The channel numbers can occur in any order. Number the channels beginning with 1 even if the board manufacturer numbers them beginning with 0. The maximum allowable channel number is 4, 8, 16, or 64 depending on the board type.

**Gain vector** — Enter a vector of numbers to select the gains for each of the channels. Available gains vary depending on board type. MF PGL gains may be set to 1, 10, 100, or 1000. MF PGH gains may be set to 1, 2, 4, or 8. MF DG-option gains may be set to 1, 2, 5, or 10.

**Mux settling time factor** — This vector must be the same length as the channel vector. It contains values of 0 or 1. If 1, the corresponding channel has a longer settling time. This is useful when using a high gain such as 100 or 1000.

**Range** — Select the voltage range from the list provided. This applies to all channels.

**Sample time** — Enter the base sample time or a multiple of the base sample time.

**PCI Slot (-1:autosearch)** — If only one board of this type is physically present in the target PC, enter

-1

to automatically locate the board.



If two or more boards of this type are physically present in the target PC, enter the bus number and the PCI slot number of the board associated with this driver block. Use the format [BusNumber, SlotNumber]. To determine the bus number and the PCI slot number, type

```
getxpcpci
```

## PD2-MFS 16-Bit Series Frame Analog Input

### Scaling Input to Output

| Hardware Input | Block Output Data Type | Scaling |
|----------------|------------------------|---------|
| volts          | Double                 | 1       |

### Driver Block Parameters

**Board type** — Select the specific board type from the list provided.

**Channel vector** — Enter a vector of numbers that make up one scan. For example, to read the first and fifth channels, enter

```
[1 5]
```

The channel numbers can occur in any order. Number the channels beginning with 1 even though the board manufacturer numbers them beginning with 0. The maximum allowable channel number is 4, 8, 16, or 64 depending on the board type.

**Gain vector** — Enter a vector of numbers to specify the gains for each of the channels in the scan. Enter a single value to use the same gain for all vectors in the scan. Available gains vary depending on board type. Allowable values depend on the board type.

- L (Low level) boards — Specify the gain as one of 1, 10, 100, or 1000.
- H (High level) boards — Specify the gain as one of 1, 2, 4, or 8.
- DG-option boards — Specify the gain as one of 1, 2, 5, or 10.

**Mux settling time vector (slow bit)** — Enter a vector that is the same length as the channel vector. Each vector element must be a 0 or 1. If you specify 1, the corresponding channel has a longer settling time. To get an accurate reading, you might want to specify a 1 for channels that have higher gains, such as 100 or 1000. Refer to the UEI PowerDAQ documentation for further information on the longer settling time. This time depends on the board type.

---

**Caution** With frame based acquisition, the additional time needed for the **Mux settling time vector (slow bit)** value might cause an acquisition overrun that xPC Target does not detect. For example, on a PD2-MF-xx-333/16H board, each nonslow acquisition takes 3 microseconds. If the slow bit is set to 1, that same acquisition takes more than 10 microseconds. With xPC Target, the scan is performed at the maximum rate for a given board. This means that the slow acquisition takes a multiple of 3 microsecond ticks. For a PD2-MF-xx-333/16H board, this becomes 12 microseconds.

For example, assume that  $N$  scans of the channel vector compose a frame of data. Assume also that you have a PD2-MF-xx-333/16H board with a **Channel vector** value of [1 2 3 4] and a **Mux settling time vector (slow bit)** value of [0 1 0 1]. For the PD2-MF-xx-333/16H board, two of the of the acquisition delays are 3 microseconds, and two are 12 microseconds. With a **Block sampletime** value of .001 second, if  $N$  is greater than 38, the data will not be acceptable. If you set all slow bits to 0,  $N$  can have a value of up to 83. The software detects the limit at  $N = 83$ , but is not aware of the extra board dependent delay.

---

**Range** — From the list, select one of the following voltage ranges. The value you select applies to all channels.

- +-10 Volts
- +-5 Volts
- 0-10 Volts
- 0-5 Volts

**Frame size** — Enter the number of samples per channel to return as a frame of data. Due to constraints in the hardware architecture, the total number of samples in a frame of data cannot exceed 1024. The relationship between the number of samples, frame size, and number of channels is

$$\text{total number of samples} = \text{FrameSize} \times \text{nChannels}$$

For example, if you specify two channels, the frame size must be less than or equal to 512.

**Output format** — From the list, select either Frame or Vector.

- **Frame** — Select Frame if you expect the output signal from this block to be the input signal for a block that requires a frame. For example, a Signal Processing block.
- **Vector** — Select Vector if you expect the output signal from this block to be the input signal for an xPC Target scope or some other block that requires vector input.

**Scan clock source** — Select Internal or External to identify the clock source for the frame scans.

**Scan time** — Enter the time (in seconds) between scans as the interval.

**Frame time** — Enter the interval (in seconds) during which the board will interrupt. The driver block evenly spaces the scans in the frame across the **Frame time** interval. If the **Frame time** interval is too short, you will receive a buffer overrun error at run time. For optimal results, experimentally increase the **Frame time** value and reiterate the process. Always rebuild the model when you change this value.

The **Frame size**, **Scan time**, and **Frame time** parameters are not independent, but are related by

$$\text{Frametime} = \text{Framesize} \times \text{Scantime}$$

After you specify two of the parameters, specify -1 for the third parameter and the equation determines the third parameter.

---

**Note** Because xPC Target uses this value to set hardware parameters on the board, you cannot change the **Frame time** value at the MATLAB prompt.

---

**Block is in an ISR** — Select this check box if the block is in an interrupt service routine (ISR). Selecting this check box forces the block sample time to -1, which enables the block to work in the ISR. If this check box is not selected, the block sample time is equal to the value of **Frame time**.

**Slave board** — If you have multiple boards configured in a master/slave combination, select this box for the slave boards only. Leave the box unchecked for the master board. (Note that a single board configuration is considered a master board.)

---

**Note** In the model, set the priority of slave blocks higher than master blocks. Right-click the slave or master block and select **Block Properties**. In the dialog, enter a value in the **Priority** property. For example, if you have multiple slave blocks, you can enter values of 2 for the slave blocks and 3 for the master block, where a lower number indicates a higher priority.

---

**Acquisition frequency** — Enter the rate at which the high speed conversion clock runs. This is the clock used to acquire each scan in a frame. For example, with a PD2-MF-xx-333/16H board, the maximum clock is 333 kHz. At that rate, the second channel in a scan will be acquired 3 microseconds after the first one in every scan of the frame.

Specify -1 to select the maximum rate available for the specified board.

**DMA burst size** — From the list, select either 32, 16, or 8. The DMA engine transfers data in packets of the burst size or less. Between each burst, a new bus arbitration cycle must complete. The best performance is achieved with higher **DMA burst size** values, with 32 being highest. However, in some architectures and with some PCI bus adaptors, a **DMA burst size** of 32 might cause problems. For example, it might lock up the target machine when DMA is attempted. In these cases, reduce the **DMA burst size** value to 8, rebuild and rerun the target application. If the DMA works at 8, select 16 to increase performance and try again.

**PCI Slot (-1:autosearch)** — If only one board of this type is physically present in the target PC, enter

-1

to automatically locate the board.

If two or more boards of this type are physically present in the target PC, enter the bus number and the PCI slot number of the board associated with this driver block. Use the format [BusNumber, SlotNumber]. To determine the bus number and the PCI slot number, type

```
getxpcpci
```

## PD2-MFS 16-Bit Series Analog Output (D/A)

### Scaling Input to Output

| Hardware Output | Block Input Data Type | Scaling |
|-----------------|-----------------------|---------|
| volts           | Double                | 1       |

### Driver Block Parameters

**Board type** — Select the specific board type from the list provided.

**Channel vector** — Enter a vector of numbers to specify the output channels 1 or 2. For example, to use the first and second analog output (D/A) channels, enter

```
[1 2]
```

The channel numbers can occur in any order. Number the channels beginning with 1 even if the board manufacturer numbers them beginning with 0.

**Reset vector** — The reset vector must be the same length as the channel vector. It contains values of 0 or 1. This parameter controls the behavior at model termination. A value of 1 causes the corresponding channel to be reset to the value specified in the initial value vector. A value of 0 causes the channel to remain at the last value attained while the model was running.

**Initial value vector** — The initial value vector must be the same length as the channel vector and should contain the initial voltage values for the output channels. The channels are set to these values between the time the model is downloaded and the time it is started.

**Sample time** — Enter the base sample time or a multiple of the base sample time.

**PCI Slot (-1:autosearch)** — If only one board of this type is physically present in the target PC, enter

-1

to automatically locate the board.

If two or more boards of this type are physically present in the target PC, enter the bus number and the PCI slot number of the board associated with this driver block. Use the format [BusNumber, SlotNumber]. To determine the bus number and the PCI slot number, type

getxpcpci

## PD2-MFS 16-Bit Series Digital Input

### Scaling Input to Output

| Hardware Input | Block Output Data Type | Scaling                         |
|----------------|------------------------|---------------------------------|
| TTL            | Double                 | TTL low = 0.0<br>TTL high = 1.0 |

### Driver Block Parameters

**Board type** — Select the specific board type from the list provided.

**Channel vector** — Enter a vector of numbers to specify the input channels. For example, to use the first and third digital input channels, enter

[1 3]

The channel numbers can occur in any order. Number the channels beginning with 1 even if the board manufacturer numbers them beginning with 0. The maximum allowable channel number is 16 for all boards except for the PD2-AO and PDXI-AO series. For those boards, the maximum channel number is 8.

**Sample time** — Enter the base sample time or a multiple of the base sample time.

**PCI Slot (-1:autosearch)** — If only one board of this type is physically present in the target PC, enter

-1

to automatically locate the board.

If two or more boards of this type are physically present in the target PC, enter the bus number and the PCI slot number of the board associated with this driver block. Use the format [BusNumber, SlotNumber]. To determine the bus number and the PCI slot number, type

```
getxpcpci
```

## PD2-MFS 16-Bit Series Digital Output

### Scaling Input to Output

| Hardware Output | Block Input Data Type | Scaling                             |
|-----------------|-----------------------|-------------------------------------|
| TTL             | Double                | < 0.5 = TTL low<br>> 0.5 = TTL high |

### Driver Block Parameters

**Board type** — Select the specific board type from the list provided.

**Channel vector** — Enter a vector of numbers to specify the output channels. For example, to use the first and third digital output channels, enter

```
[1 3]
```

The channel numbers can occur in any order. Number the channels beginning with 1 even if the board manufacturer numbers them beginning with 0. The maximum allowable channel number is 16 for all board types except for the PD2-AO and PDXI-AO series. For those boards, the maximum channel number is 8.

**Reset vector** — The reset vector must be the same length as the channel vector. It contains values of 0 or 1. This parameter controls the behavior at model termination. A value of 1 causes the corresponding channel to be reset

to the value specified in the initial value vector. A value of 0 causes the channel to remain at the last value attained while the model was running.

**Initial value vector** — The initial value vector must be the same length as the channel vector. It contains the initial values (0 or 1) for the output channels. The channels are set to these values between the time the model is downloaded and the time it is started.

**Sample time** — Enter the base sample time or a multiple of the base sample time.

**PCI Slot (-1:autosearch)** — If only one board of this type is physically present in the target PC, enter

- 1

to automatically locate the board.

If two or more boards of this type are physically present in the target PC, enter the bus number and the PCI slot number of the board associated with this driver block. Use the format [BusNumber, SlotNumber]. To determine the bus number and the PCI slot number, type

getxpcpci



## PDXI-MF 12-Bit Series

The PDXI-MF 12-bit series contains I/O boards with 16 or 64 single or 8 or 32 differential analog input (A/D) channels (12-bit) with a maximum sample rate of 1.25MHz. The gain varies from 1 to 8 or 1 to 1000. The boards also have 2 analog output (D/A) channels (12-bit), 16 digital input, and 16 digital output lines. xPC Target does not support the counter/timers on these boards.

xPC Target supports this series of boards with these driver blocks:

- “PDXI-MF 12-Bit Series Analog Input (A/D)” on page 30-74
- “PDXI-MF 12-Bit Series Frame Analog Input” on page 30-75
- “PDXI-MF 12-Bit Series Analog Output (D/A)” on page 30-79
- “PDXI-MF 12-Bit Series Digital Input” on page 30-80
- “PDXI-MF 12-Bit Series Digital Output” on page 30-81

### Board Characteristics

|                                 |                                                                                  |
|---------------------------------|----------------------------------------------------------------------------------|
| Board type                      | PDXI-MF-16-1M/12L<br>PDXI-MF-16-1M/12H<br>PDXI-MF-64-1M/12L<br>PDXI-MF-64-1M/12H |
| Manufacturer                    | United Electronic Industries (UEI)                                               |
| Bus type                        | CompactPCI, PXI                                                                  |
| Access method                   | Memory mapped                                                                    |
| Multiple block instance support | No                                                                               |
| Multiple board support          | Yes                                                                              |

## PDXI-MF 12-Bit Series Analog Input (A/D)

### Scaling Input to Output

| Hardware Input | Block Output Data Type | Scaling |
|----------------|------------------------|---------|
| volts          | Double                 | 1       |

### Driver Block Parameters

**Board type** — Select the specific board type from the list provided.

**Channel vector** — Enter a vector of numbers to specify the input channels. For example, use the first and third analog input (A/D) channels, enter

[1 3]

The channel numbers can occur in any order. Number the channels beginning with 1 even if the board manufacturer numbers them beginning with 0. The maximum allowable channel number is 4, 8, 16, or 64 depending on the board type.

**Gain vector** — Enter a vector of numbers to select the gains for each of the channels. Available gains vary depending on board type. MF PGL gains may be set to 1, 10, 100, or 1000. MF PGH gains may be set to 1, 2, 4, or 8. MF DG-option gains may be set to 1, 2, 5, or 10.

**Mux settling time factor** — This vector must be the same length as the channel vector. It contains values of 0 or 1. If 1, the corresponding channel has a longer settling time. This is useful when using a high gain such as 100 or 1000.

**Range** — Select the voltage range from the list provided. This applies to all channels.

**Sample time** — Enter the base sample time or a multiple of the base sample time.

**PCI Slot (-1:autosearch)** — If only one board of this type is physically present in the target PC, enter

-1

to automatically locate the board.

If two or more boards of this type are physically present in the target PC, enter the bus number and the PCI slot number of the board associated with this driver block. Use the format [BusNumber, SlotNumber]. To determine the bus number and the PCI slot number, type

```
getxpcpci
```

## PDXI-MF 12-Bit Series Frame Analog Input

### Scaling Input to Output

| Hardware Input | Block Output Data Type | Scaling |
|----------------|------------------------|---------|
| volts          | Double                 | 1       |

### Driver Block Parameters

**Board type** — Select the specific board type from the list provided.

**Channel vector** — Enter a vector of numbers that make up one scan. For example, to read the first and fifth channels, enter

```
[1 5]
```

The channel numbers can occur in any order. Number the channels beginning with 1 even though the board manufacturer numbers them beginning with 0. The maximum allowable channel number is 4, 8, 16, or 64 depending on the board type.

**Gain vector** — Enter a vector of numbers to specify the gains for each of the channels in the scan. Enter a single value to use the same gain for all vectors in the scan. Available gains vary depending on board type. Allowable values depend on the board type.

- L (Low level) boards — Specify the gain as one of 1, 10, 100, or 1000.
- H (High level) boards — Specify the gain as one of 1, 2, 4, or 8.
- DG-option boards — Specify the gain as one of 1, 2, 5, or 10.

**Mux settling time vector (slow bit)** — Enter a vector that is the same length as the channel vector. Each vector element must be a 0 or 1. If you specify 1, the corresponding channel has a longer settling time. To get an accurate reading, you might want to specify a 1 for channels that have higher gains, such as 100 or 1000. Refer to the UEI PowerDAQ documentation for further information on the longer settling time. This time depends on the board type.

---

**Caution** With frame based acquisition, the additional time needed for the **Mux settling time vector (slow bit)** value might cause an acquisition overrun that xPC Target does not detect. For example, on a PD2-MF-xx-333/16H board, each nonslow acquisition takes 3 microseconds. If the slow bit is set to 1, that same acquisition takes more than 10 microseconds. With xPC Target, the scan is performed at the maximum rate for a given board. This means that the slow acquisition takes a multiple of 3 microsecond ticks. For a PD2-MF-xx-333/16H board, this becomes 12 microseconds.

For example, assume that  $N$  scans of the channel vector compose a frame of data. Assume also that you have a PD2-MF-xx-333/16H board with a **Channel vector** value of [1 2 3 4] and a **Mux settling time vector (slow bit)** value of [0 1 0 1]. For the PD2-MF-xx-333/16H board, two of the of the acquisition delays are 3 microseconds, and two are 12 microseconds. With a **Block sampletime** value of .001 second, if  $N$  is greater than 38, the data will not be acceptable. If you set all slow bits to 0,  $N$  can have a value of up to 83. The software detects the limit at  $N = 83$ , but is not aware of the extra board dependent delay.

---

**Range** — From the list, select one of the following voltage ranges. The value you select applies to all channels.

- +-10 Volts
- +-5 Volts
- 0-10 Volts
- 0-5 Volts

**Input coupling mode** — From the list, select one from the following list of input coupling modes:

- Single Ended
- Differential

Refer to the UEI PowerDAQ documentation for input connections.

**Frame size** — Enter the number of samples per channel to return as a frame of data. Due to constraints in the hardware architecture, the total number of samples in a frame of data cannot exceed 1024. The relationship between the number of samples, frame size, and number of channels is

$$\text{total number of samples} = \text{FrameSize} \times \text{nChannels}$$

For example, if you specify two channels, the frame size must be less than or equal to 512.

**Output format** — From the list, select either Frame or Vector.

- Frame — Select Frame if you expect the output signal from this block to be the input signal for a block that requires a frame. For example, a Signal Processing block.
- Vector — Select Vector if you expect the output signal from this block to be the input signal for an xPC Target scope or some other block that requires vector input.

**Scan clock source** — Select Internal or External to identify the clock source for the frame scans.

**Scan time** — Enter the time (in seconds) between scans as the interval.

**Frame time** — Enter the interval (in seconds) during which the board will interrupt. The driver block evenly spaces the scans in the frame across the **Frame time** interval. If the **Frame time** interval is too short, you will receive a buffer overrun error at run time. For optimal results, experimentally increase the **Frame time** value and reiterate the process. Always rebuild the model when you change this value.

The **Frame size**, **Scan time**, and **Frame time** parameters are not independent, but are related by

$$\text{Frame time} = \text{Framesize} \times \text{Scan time}$$

After you specify two of the parameters, specify -1 for the third parameter and the equation determines the third parameter.

---

**Note** Because xPC Target uses this value to set hardware parameters on the board, you cannot change the **Frame time** value at the MATLAB prompt.

---

**Block is in an ISR** — Select this check box if the block is in an interrupt service routine (ISR). Selecting this check box forces the block sample time to -1, which enables the block to work in the ISR. If this check box is not selected, the block sample time is equal to the value of **Frame time**.

**Slave board** — If you have multiple boards configured in a master/slave combination, select this box for the slave boards only. Leave the box unchecked for the master board. (Note that a single board configuration is considered a master board.)

---

**Note** In the model, set the priority of slave blocks higher than master blocks. Right-click the slave or master block and select **Block Properties**. In the dialog, enter a value in the **Priority** property. For example, if you have multiple slave blocks, you can enter values of 2 for the slave blocks and 3 for the master block, where a lower number indicates a higher priority.

---

**Acquisition frequency** — Enter the rate at which the high speed conversion clock runs. This is the clock used to acquire each scan in a frame. For example, with a PD2-MF-xx-333/16H board, the maximum clock is 333 kHz. At that rate, the second channel in a scan will be acquired 3 microseconds after the first one in every scan of the frame.

Specify -1 to select the maximum rate available for the specified board.

**DMA burst size** — From the list, select either 32, 16, or 8. The DMA engine transfers data in packets of the burst size or less. Between each burst, a new bus arbitration cycle must complete. The best performance is achieved with higher **DMA burst size** values, with 32 being highest. However, in some architectures and with some PCI bus adaptors, a **DMA burst size** of 32 might cause problems. For example, it might lock up the target machine when DMA is attempted. In these cases, reduce the **DMA burst size** value to 8, rebuild and rerun the target application. If the DMA works at 8, select 16 to increase performance and try again.

**PCI Slot (-1:autosearch)** — If only one board of this type is physically present in the target PC, enter

-1

to automatically locate the board.

If two or more boards of this type are physically present in the target PC, enter the bus number and the PCI slot number of the board associated with this driver block. Use the format [BusNumber, SlotNumber]. To determine the bus number and the PCI slot number, type

```
getxpcpci
```

## PDXI-MF 12-Bit Series Analog Output (D/A)

### Scaling Input to Output

| Hardware Output | Block Input Data Type | Scaling |
|-----------------|-----------------------|---------|
| volts           | Double                | 1       |

### Driver Block Parameters

**Board type** — Select the specific board type from the list provided.

**Channel vector** — Enter a vector of numbers to specify the output channels between 1 and 16. For example, to use the first and second analog output (D/A) channels, enter

```
[1 2]
```

The channel numbers can occur in any order. Number the channels beginning with 1 even if the board manufacturer numbers them beginning with 0. The maximum allowable channel number for PD2-AO and PDXI-AO series boards is 8, 16, or 32 depending on the specific board type. For all other boards series the maximum channel number is 2.

**Reset vector** — The reset vector must be the same length as the channel vector. It contains values of 0 or 1. This parameter controls the behavior at model termination. A value of 1 causes the corresponding channel to be reset to the value specified in the initial value vector. A value of 0 causes the channel to remain at the last value attained while the model was running.

**Initial value vector** — The initial value vector must be the same length as the channel vector and should contain the initial voltage values for the output channels. The channels are set to these values between the time the model is downloaded and the time it is started.

**Sample time** — Enter the base sample time or a multiple of the base sample time.

**PCI Slot (-1:autosearch)** — If only one board of this type is physically present in the target PC, enter

-1

to automatically locate the board.

If two or more boards of this type are physically present in the target PC, enter the bus number and the PCI slot number of the board associated with this driver block. Use the format [BusNumber, SlotNumber]. To determine the bus number and the PCI slot number, type

getxpcpci

## PDXI-MF 12-Bit Series Digital Input

### Scaling Input to Output

| Hardware Input | Block Output Data Type | Scaling                         |
|----------------|------------------------|---------------------------------|
| TTL            | Double                 | TTL low = 0.0<br>TTL high = 1.0 |

### Driver Block Parameters

**Board type** — Select the specific board type from the list provided.

**Channel vector** — Enter a vector of numbers to specify the input channels. For example, to use the first and third digital input channels, enter

[1 3]

The channel numbers can occur in any order. Number the channels beginning with 1 even if the board manufacturer numbers them beginning with 0. The



maximum allowable channel number is 16 for all boards except for the PD2-AO and PDXI-AO series. For those boards, the maximum channel number is 8.

**Sample time** — Enter the base sample time or a multiple of the base sample time.

**PCI Slot (-1:autosearch)** — If only one board of this type is physically present in the target PC, enter

-1

to automatically locate the board.

If two or more boards of this type are physically present in the target PC, enter the bus number and the PCI slot number of the board associated with this driver block. Use the format [BusNumber, SlotNumber]. To determine the bus number and the PCI slot number, type

```
getxpcpci
```

## PDXI-MF 12-Bit Series Digital Output

### Scaling Input to Output

| Hardware Output | Block Input Data Type | Scaling                             |
|-----------------|-----------------------|-------------------------------------|
| TTL             | Double                | < 0.5 = TTL low<br>> 0.5 = TTL high |

### Driver Block Parameters

**Board type** — Select the specific board type from the list provided.

**Channel vector** — Enter a vector of numbers to specify the output channels. For example, to use the first and third digital output channels, enter

```
[1 3]
```

The channel numbers can occur in any order. Number the channels beginning with 1 even if the board manufacturer numbers them beginning with 0. The maximum allowable channel number is 16 for all board types except for the PD2-AO and PDXI-AO series. For those boards, the maximum channel number is 8.

**Reset vector** — The reset vector must be the same length as the channel vector. It contains values of 0 or 1. This parameter controls the behavior at model termination. A value of 1 causes the corresponding channel to be reset to the value specified in the initial value vector. A value of 0 causes the channel to remain at the last value attained while the model was running.

**Initial value vector** — The initial value vector must be the same length as the channel vector. It contains the initial values (0 or 1) for the output channels. The channels are set to these values between the time the model is downloaded and the time it is started.

**Sample time** — Enter the base sample time or a multiple of the base sample time.

**PCI Slot (-1:autosearch)** — If only one board of this type is physically present in the target PC, enter

-1

to automatically locate the board.

If two or more boards of this type are physically present in the target PC, enter the bus number and the PCI slot number of the board associated with this driver block. Use the format [BusNumber, SlotNumber]. To determine the bus number and the PCI slot number, type

```
getxpcpci
```

## PDXI-MF 14-Bit Series

The PDXI-MF 14-bit series contains I/O boards with 16 or 64 single or 8 or 32 differential analog input (A/D) channels (14-bit). The boards also have 2 analog output (D/A) channels (12-bit), 16 digital input, and 16 digital output lines. xPC Target does not support the counter/timers on these boards.

xPC Target supports this series of boards with these driver blocks:

- “PDXI-MF 14-Bit Series Analog Input (A/D)” on page 30-84
- “PDXI-MF 14-Bit Series Frame Analog Input” on page 30-85
- “PDXI-MF 14-Bit Series Analog Output (D/A)” on page 30-89
- “PDXI-MF 14-Bit Series Digital Input” on page 30-90
- “PDXI-MF 14-Bit Series Digital Output” on page 30-91

### Board Characteristics

|                                 |                                                                                                                                |
|---------------------------------|--------------------------------------------------------------------------------------------------------------------------------|
| Board type                      | PDXI-MF-16-400/14L<br>PDXI-MF-16-400/14H<br>PDXI-MF-64-400/14L<br>PDXI-MF-64-400/14H<br>PDXI-MF-16-2M/14H<br>PDXI-MF-64-2M/14H |
| Manufacturer                    | United Electronic Industries (UEI)                                                                                             |
| Bus type                        | CompactPCI, PXI                                                                                                                |
| Access method                   | Memory mapped                                                                                                                  |
| Multiple block instance support | No                                                                                                                             |
| Multiple board support          | Yes                                                                                                                            |

## PDXI-MF 14-Bit Series Analog Input (A/D)

### Scaling Input to Output

| Hardware Input | Block Output Data Type | Scaling |
|----------------|------------------------|---------|
| volts          | Double                 | 1       |

### Driver Block Parameters

**Board type** — Select the specific board type from the list provided.

**Channel vector** — Enter a vector of numbers to specify the input channels. For example, use the first and third analog input (A/D) channels, enter

[1 3]

The channel numbers can occur in any order. Number the channels beginning with 1 even if the board manufacturer numbers them beginning with 0. The maximum allowable channel number is 4, 8, 16, or 64 depending on the board type.

**Gain vector** — Enter a vector of numbers to select the gains for each of the channels. Available gains vary depending on board type. MF PGL gains may be set to 1, 10, 100, or 1000. MF PGH gains may be set to 1, 2, 4, or 8. MF DG-option gains may be set to 1, 2, 5, or 10.

**Mux settling time factor** — This vector must be the same length as the channel vector. It contains values of 0 or 1. If 1, the corresponding channel has a longer settling time. This is useful when using a high gain such as 100 or 1000.

**Range** — Select the voltage range from the list provided. This applies to all channels.

**Sample time** — Enter the base sample time or a multiple of the base sample time.

**PCI Slot (-1:autosearch)** — If only one board of this type is physically present in the target PC, enter

-1

to automatically locate the board.

If two or more boards of this type are physically present in the target PC, enter the bus number and the PCI slot number of the board associated with this driver block. Use the format [BusNumber, SlotNumber]. To determine the bus number and the PCI slot number, type

```
getxpcpci
```

## PDXI-MF 14-Bit Series Frame Analog Input

### Scaling Input to Output

| Hardware Input | Block Output Data Type | Scaling |
|----------------|------------------------|---------|
| volts          | Double                 | 1       |

### Driver Block Parameters

**Board type** — Select the specific board type from the list provided.

**Channel vector** — Enter a vector of numbers that make up one scan. For example, to read the first and fifth channels, enter

```
[1 5]
```

The channel numbers can occur in any order. Number the channels beginning with 1 even though the board manufacturer numbers them beginning with 0. The maximum allowable channel number is 4, 8, 16, or 64 depending on the board type.

**Gain vector** — Enter a vector of numbers to specify the gains for each of the channels in the scan. Enter a single value to use the same gain for all vectors in the scan. Available gains vary depending on board type. Allowable values depend on the board type.

- L (Low level) boards — Specify the gain as one of 1, 10, 100, or 1000.
- H (High level) boards — Specify the gain as one of 1, 2, 4, or 8.
- DG-option boards — Specify the gain as one of 1, 2, 5, or 10.

**Mux settling time vector (slow bit)** — Enter a vector that is the same length as the channel vector. Each vector element must be a 0 or 1. If you specify 1, the corresponding channel has a longer settling time. To get an accurate reading, you might want to specify a 1 for channels that have higher gains, such as 100 or 1000. Refer to the UEI PowerDAQ documentation for further information on the longer settling time. This time depends on the board type.

---

**Caution** With frame based acquisition, the additional time needed for the **Mux settling time vector (slow bit)** value might cause an acquisition overrun that xPC Target does not detect. For example, on a PD2-MF-xx-333/16H board, each nonslow acquisition takes 3 microseconds. If the slow bit is set to 1, that same acquisition takes more than 10 microseconds. With xPC Target, the scan is performed at the maximum rate for a given board. This means that the slow acquisition takes a multiple of 3 microsecond ticks. For a PD2-MF-xx-333/16H board, this becomes 12 microseconds.

For example, assume that  $N$  scans of the channel vector compose a frame of data. Assume also that you have a PD2-MF-xx-333/16H board with a **Channel vector** value of [1 2 3 4] and a **Mux settling time vector (slow bit)** value of [0 1 0 1]. For the PD2-MF-xx-333/16H board, two of the of the acquisition delays are 3 microseconds, and two are 12 microseconds. With a **Block sampletime** value of .001 second, if  $N$  is greater than 38, the data will not be acceptable. If you set all slow bits to 0,  $N$  can have a value of up to 83. The software detects the limit at  $N = 83$ , but is not aware of the extra board dependent delay.

---

**Range** — From the list, select one of the following voltage ranges. The value you select applies to all channels.

- +-10 Volts
- +-5 Volts
- 0-10 Volts
- 0-5 Volts

**Input coupling mode** — From the list, select one from the following list of input coupling modes:

- Single Ended
- Differential

Refer to the UEI PowerDAQ documentation for input connections.

**Frame size** — Enter the number of samples per channel to return as a frame of data. Due to constraints in the hardware architecture, the total number of samples in a frame of data cannot exceed 1024. The relationship between the number of samples, frame size, and number of channels is

$$\text{total number of samples} = \text{FrameSize} \times \text{nChannels}$$

For example, if you specify two channels, the frame size must be less than or equal to 512.

**Output format** — From the list, select either Frame or Vector.

- Frame — Select Frame if you expect the output signal from this block to be the input signal for a block that requires a frame. For example, a Signal Processing block.
- Vector — Select Vector if you expect the output signal from this block to be the input signal for an xPC Target scope or some other block that requires vector input.

**Scan clock source** — Select Internal or External to identify the clock source for the frame scans.

**Scan time** — Enter the time (in seconds) between scans as the interval.

**Frame time** — Enter the interval (in seconds) during which the board will interrupt. The driver block evenly spaces the scans in the frame across the **Frame time** interval. If the **Frame time** interval is too short, you will receive a buffer overrun error at run time. For optimal results, experimentally increase the **Frame time** value and reiterate the process. Always rebuild the model when you change this value.

The **Frame size**, **Scan time**, and **Frame time** parameters are not independent, but are related by

$$\text{Frame time} = \text{Framesize} \times \text{Scan time}$$

After you specify two of the parameters, specify -1 for the third parameter and the equation determines the third parameter.

---

**Note** Because xPC Target uses this value to set hardware parameters on the board, you cannot change the **Frame time** value at the MATLAB prompt.

---

**Block is in an ISR** — Select this check box if the block is in an interrupt service routine (ISR). Selecting this check box forces the block sample time to -1, which enables the block to work in the ISR. If this check box is not selected, the block sample time is equal to the value of **Frame time**.

**Slave board** — If you have multiple boards configured in a master/slave combination, select this box for the slave boards only. Leave the box unchecked for the master board. (Note that a single board configuration is considered a master board.)

---

**Note** In the model, set the priority of slave blocks higher than master blocks. Right-click the slave or master block and select **Block Properties**. In the dialog, enter a value in the **Priority** property. For example, if you have multiple slave blocks, you can enter values of 2 for the slave blocks and 3 for the master block, where a lower number indicates a higher priority.

---

**Acquisition frequency** — Enter the rate at which the high speed conversion clock runs. This is the clock used to acquire each scan in a frame. For example, with a PD2-MF-xx-333/16H board, the maximum clock is 333 kHz. At that rate, the second channel in a scan will be acquired 3 microseconds after the first one in every scan of the frame.

Specify -1 to select the maximum rate available for the specified board.

**DMA burst size** — From the list, select either 32, 16, or 8. The DMA engine transfers data in packets of the burst size or less. Between each burst, a new bus arbitration cycle must complete. The best performance is achieved with higher **DMA burst size** values, with 32 being highest. However, in some architectures and with some PCI bus adaptors, a **DMA burst size** of 32 might cause problems. For example, it might lock up the target machine when DMA is attempted. In these cases, reduce the **DMA burst size** value to 8, rebuild and rerun the target application. If the DMA works at 8, select 16 to increase performance and try again.



**PCI Slot (-1:autosearch)** — If only one board of this type is physically present in the target PC, enter

-1

to automatically locate the board.

If two or more boards of this type are physically present in the target PC, enter the bus number and the PCI slot number of the board associated with this driver block. Use the format [BusNumber, SlotNumber]. To determine the bus number and the PCI slot number, type

```
getxpcpci
```

## PDXI-MF 14-Bit Series Analog Output (D/A)

### Scaling Input to Output

| Hardware Output | Block Input Data Type | Scaling |
|-----------------|-----------------------|---------|
| volts           | Double                | 1       |

### Driver Block Parameters

**Board type** — Select the specific board type from the list provided.

**Channel vector** — Enter a vector of numbers to specify the output channels between 1 and 16. For example, to use the first and second analog output (D/A) channels, enter

```
[1 2]
```

The channel numbers can occur in any order. Number the channels beginning with 1 even if the board manufacturer numbers them beginning with 0. The maximum allowable channel number for PD2-AO and PDXI-AO series boards is 8, 16, or 32 depending on the specific board type. For all other boards series the maximum channel number is 2.

**Reset vector** — The reset vector must be the same length as the channel vector. It contains values of 0 or 1. This parameter controls the behavior at model termination. A value of 1 causes the corresponding channel to be reset to the value specified in the initial value vector. A value of 0 causes the channel to remain at the last value attained while the model was running.

**Initial value vector** — The initial value vector must be the same length as the channel vector and should contain the initial voltage values for the output channels. The channels are set to these values between the time the model is downloaded and the time it is started.

**Sample time** — Enter the base sample time or a multiple of the base sample time.

**PCI Slot (-1:autosearch)** — If only one board of this type is physically present in the target PC, enter

-1

to automatically locate the board.

If two or more boards of this type are physically present in the target PC, enter the bus number and the PCI slot number of the board associated with this driver block. Use the format [BusNumber, SlotNumber]. To determine the bus number and the PCI slot number, type

getxpcpci

## PDXI-MF 14-Bit Series Digital Input

### Scaling Input to Output

| Hardware Input | Block Output Data Type | Scaling                         |
|----------------|------------------------|---------------------------------|
| TTL            | Double                 | TTL low = 0.0<br>TTL high = 1.0 |

### Driver Block Parameters

**Board type** — Select the specific board type from the list provided.

**Channel vector** — Enter a vector of numbers to specify the input channels. For example, to use the first and third digital input channels, enter

[1 3]

The channel numbers can occur in any order. Number the channels beginning with 1 even if the board manufacturer numbers them beginning with 0. The

maximum allowable channel number is 16 for all boards except for the PD2-AO and PDXI-AO series. For those boards, the maximum channel number is 8.

**Sample time** — Enter the base sample time or a multiple of the base sample time.

**PCI Slot (-1:autosearch)** — If only one board of this type is physically present in the target PC, enter

-1

to automatically locate the board.

If two or more boards of this type are physically present in the target PC, enter the bus number and the PCI slot number of the board associated with this driver block. Use the format [BusNumber, SlotNumber]. To determine the bus number and the PCI slot number, type

```
getxpcpci
```

## PDXI-MF 14-Bit Series Digital Output

### Scaling Input to Output

| Hardware Output | Block Input Data Type | Scaling                             |
|-----------------|-----------------------|-------------------------------------|
| TTL             | Double                | < 0.5 = TTL low<br>> 0.5 = TTL high |

### Driver Block Parameters

**Board type** — Select the specific board type from the list provided.

**Channel vector** — Enter a vector of numbers to specify the output channels. For example, to use the first and third digital output channels, enter

```
[1 3]
```

The channel numbers can occur in any order. Number the channels beginning with 1 even if the board manufacturer numbers them beginning with 0. The maximum allowable channel number is 16 for all board types except for the PD2-AO and PDXI-AO series. For those boards, the maximum channel number is 8.

**Reset vector** — The reset vector must be the same length as the channel vector. It contains values of 0 or 1. This parameter controls the behavior at model termination. A value of 1 causes the corresponding channel to be reset to the value specified in the initial value vector. A value of 0 causes the channel to remain at the last value attained while the model was running.

**Initial value vector** — The initial value vector must be the same length as the channel vector. It contains the initial values (0 or 1) for the output channels. The channels are set to these values between the time the model is downloaded and the time it is started.

**Sample time** — Enter the base sample time or a multiple of the base sample time.

**PCI Slot (-1:autosearch)** — If only one board of this type is physically present in the target PC, enter

-1

to automatically locate the board.

If two or more boards of this type are physically present in the target PC, enter the bus number and the PCI slot number of the board associated with this driver block. Use the format [BusNumber, SlotNumber]. To determine the bus number and the PCI slot number, type

```
getxpcpci
```

## PDXI-MF 16-Bit Series

The PDXI-MF 16-bit series contains I/O boards with 16 or 64 single or 8 or 32 differential analog input (A/D) channels (16-bit). The boards also have 2 analog output (D/A) channels (12-bit), 16 digital input, and 16 digital output lines. xPC Target does not support the counter/timers on these boards.

xPC Target supports this series of boards with these driver blocks:

- “PDXI-MF 16-Bit Series Analog Input (A/D)” on page 30-94
- “PDXI-MF 16-Bit Series Frame Analog Input” on page 30-95
- “PDXI-MF 16-Bit Series Analog Output (D/A)” on page 30-99
- “PDXI-MF 16-Bit Series Digital Input” on page 30-100
- “PDXI-MF 16-Bit Series Digital Output” on page 30-101

### Board Characteristics

|                                 |                                                                                                                                                                              |
|---------------------------------|------------------------------------------------------------------------------------------------------------------------------------------------------------------------------|
| Board type                      | PDXI-MF-16-333/16L<br>PDXI-MF-16-333/16H<br>PDXI-MF-64-333/16L<br>PDXI-MF-64-333/16H<br>PDXI-MF-16-500/16L<br>PDXI-MF-16-500/16H<br>PDXI-MF-64-500/16L<br>PDXI-MF-64-500/16H |
| Manufacturer                    | United Electronic Industries (UEI)                                                                                                                                           |
| Bus type                        | CompactPCI, PXI                                                                                                                                                              |
| Access method                   | Memory mapped                                                                                                                                                                |
| Multiple block instance support | No                                                                                                                                                                           |
| Multiple board support          | Yes                                                                                                                                                                          |

## PDXI-MF 16-Bit Series Analog Input (A/D)

### Scaling Input to Output

| Hardware Input | Block Output Data Type | Scaling |
|----------------|------------------------|---------|
| volts          | Double                 | 1       |

### Driver Block Parameters

**Board type** — Select the specific board type from the list provided.

**Channel vector** — Enter a vector of numbers to specify the input channels. For example, use the first and third analog input (A/D) channels, enter

[1 3]

The channel numbers can occur in any order. Number the channels beginning with 1 even if the board manufacturer numbers them beginning with 0. The maximum allowable channel number is 4, 8, 16, or 64 depending on the board type.

**Gain vector** — Enter a vector of numbers to select the gains for each of the channels. Available gains vary depending on board type. MF PGL gains may be set to 1, 10, 100, or 1000. MF PGH gains may be set to 1, 2, 4, or 8. MF DG-option gains may be set to 1, 2, 5, or 10.

**Mux settling time factor** — This vector must be the same length as the channel vector. It contains values of 0 or 1. If 1, the corresponding channel has a longer settling time. This is useful when using a high gain such as 100 or 1000.

**Range** — Select the voltage range from the list provided. This applies to all channels.

**Sample time** — Enter the base sample time or a multiple of the base sample time.

**PCI Slot (-1:autosearch)** — If only one board of this type is physically present in the target PC, enter

-1

to automatically locate the board.

If two or more boards of this type are physically present in the target PC, enter the bus number and the PCI slot number of the board associated with this driver block. Use the format [BusNumber, SlotNumber]. To determine the bus number and the PCI slot number, type

```
getxpcpci
```

## PDXI-MF 16-Bit Series Frame Analog Input

### Scaling Input to Output

| Hardware Input | Block Output Data Type | Scaling |
|----------------|------------------------|---------|
| volts          | Double                 | 1       |

### Driver Block Parameters

**Board type** — Select the specific board type from the list provided.

**Channel vector** — Enter a vector of numbers that make up one scan. For example, to read the first and fifth channels, enter

```
[1 5]
```

The channel numbers can occur in any order. Number the channels beginning with 1 even though the board manufacturer numbers them beginning with 0. The maximum allowable channel number is 4, 8, 16, or 64 depending on the board type.

**Gain vector** — Enter a vector of numbers to specify the gains for each of the channels in the scan. Enter a single value to use the same gain for all vectors in the scan. Available gains vary depending on board type. Allowable values depend on the board type.

- L (Low level) boards — Specify the gain as one of 1, 10, 100, or 1000.
- H (High level) boards — Specify the gain as one of 1, 2, 4, or 8.
- DG-option boards — Specify the gain as one of 1, 2, 5, or 10.

**Mux settling time vector (slow bit)** — Enter a vector that is the same length as the channel vector. Each vector element must be a 0 or 1. If you specify 1, the corresponding channel has a longer settling time. To get an accurate reading, you might want to specify a 1 for channels that have higher gains, such as 100 or 1000. Refer to the UEI PowerDAQ documentation for further information on the longer settling time. This time depends on the board type.

---

**Caution** With frame based acquisition, the additional time needed for the **Mux settling time vector (slow bit)** value might cause an acquisition overrun that xPC Target does not detect. For example, on a PD2-MF-xx-333/16H board, each nonslow acquisition takes 3 microseconds. If the slow bit is set to 1, that same acquisition takes more than 10 microseconds. With xPC Target, the scan is performed at the maximum rate for a given board. This means that the slow acquisition takes a multiple of 3 microsecond ticks. For a PD2-MF-xx-333/16H board, this becomes 12 microseconds.

For example, assume that  $N$  scans of the channel vector compose a frame of data. Assume also that you have a PD2-MF-xx-333/16H board with a **Channel vector** value of [1 2 3 4] and a **Mux settling time vector (slow bit)** value of [0 1 0 1]. For the PD2-MF-xx-333/16H board, two of the of the acquisition delays are 3 microseconds, and two are 12 microseconds. With a **Block sampletime** value of .001 second, if  $N$  is greater than 38, the data will not be acceptable. If you set all slow bits to 0,  $N$  can have a value of up to 83. The software detects the limit at  $N = 83$ , but is not aware of the extra board dependent delay.

---

**Range** — From the list, select one of the following voltage ranges. The value you select applies to all channels.

- +-10 Volts
- +-5 Volts
- 0-10 Volts
- 0-5 Volts

**Input coupling mode** — From the list, select one from the following list of input coupling modes:



- Single Ended
- Differential

Refer to the UEI PowerDAQ documentation for input connections.

**Frame size** — Enter the number of samples per channel to return as a frame of data. Due to constraints in the hardware architecture, the total number of samples in a frame of data cannot exceed 1024. The relationship between the number of samples, frame size, and number of channels is

$$\text{total number of samples} = \text{FrameSize} \times \text{nChannels}$$

For example, if you specify two channels, the frame size must be less than or equal to 512.

**Output format** — From the list, select either Frame or Vector.

- Frame — Select Frame if you expect the output signal from this block to be the input signal for a block that requires a frame. For example, a Signal Processing block.
- Vector — Select Vector if you expect the output signal from this block to be the input signal for an xPC Target scope or some other block that requires vector input.

**Scan clock source** — Select Internal or External to identify the clock source for the frame scans.

**Scan time** — Enter the time (in seconds) between scans as the interval.

**Frame time** — Enter the interval (in seconds) during which the board will interrupt. The driver block evenly spaces the scans in the frame across the **Frame time** interval. If the **Frame time** interval is too short, you will receive a buffer overrun error at run time. For optimal results, experimentally increase the **Frame time** value and reiterate the process. Always rebuild the model when you change this value.

The **Frame size**, **Scan time**, and **Frame time** parameters are not independent, but are related by

$$\text{Frame time} = \text{Framesize} \times \text{Scan time}$$

After you specify two of the parameters, specify -1 for the third parameter and the equation determines the third parameter.

---

**Note** Because xPC Target uses this value to set hardware parameters on the board, you cannot change the **Frame time** value at the MATLAB prompt.

---

**Block is in an ISR** — Select this check box if the block is in an interrupt service routine (ISR). Selecting this check box forces the block sample time to -1, which enables the block to work in the ISR. If this check box is not selected, the block sample time is equal to the value of **Frame time**.

**Slave board** — If you have multiple boards configured in a master/slave combination, select this box for the slave boards only. Leave the box unchecked for the master board. (Note that a single board configuration is considered a master board.)

---

**Note** In the model, set the priority of slave blocks higher than master blocks. Right-click the slave or master block and select **Block Properties**. In the dialog, enter a value in the **Priority** property. For example, if you have multiple slave blocks, you can enter values of 2 for the slave blocks and 3 for the master block, where a lower number indicates a higher priority.

---

**Acquisition frequency** — Enter the rate at which the high speed conversion clock runs. This is the clock used to acquire each scan in a frame. For example, with a PD2-MF-xx-333/16H board, the maximum clock is 333 kHz. At that rate, the second channel in a scan will be acquired 3 microseconds after the first one in every scan of the frame.

Specify -1 to select the maximum rate available for the specified board.

**DMA burst size** — From the list, select either 32, 16, or 8. The DMA engine transfers data in packets of the burst size or less. Between each burst, a new bus arbitration cycle must complete. The best performance is achieved with higher **DMA burst size** values, with 32 being highest. However, in some architectures and with some PCI bus adaptors, a **DMA burst size** of 32 might cause problems. For example, it might lock up the target machine when DMA is attempted. In these cases, reduce the **DMA burst size** value to 8, rebuild and rerun the target application. If the DMA works at 8, select 16 to increase performance and try again.

**PCI Slot (-1:autosearch)** — If only one board of this type is physically present in the target PC, enter

-1

to automatically locate the board.

If two or more boards of this type are physically present in the target PC, enter the bus number and the PCI slot number of the board associated with this driver block. Use the format [BusNumber, SlotNumber]. To determine the bus number and the PCI slot number, type

```
getxpcpci
```

## PDXI-MF 16-Bit Series Analog Output (D/A)

### Scaling Input to Output

| Hardware Output | Block Input Data Type | Scaling |
|-----------------|-----------------------|---------|
| volts           | Double                | 1       |

### Driver Block Parameters

**Board type** — Select the specific board type from the list provided.

**Channel vector** — Enter a vector of numbers to specify the output channels between 1 and 16. For example, to use the first and second analog output (D/A) channels, enter

```
[1 2]
```

The channel numbers can occur in any order. Number the channels beginning with 1 even if the board manufacturer numbers them beginning with 0. The maximum allowable channel number for PD2-AO and PDXI-AO series boards is 8, 16, or 32 depending on the specific board type. For all other boards series the maximum channel number is 2.

**Reset vector** — The reset vector must be the same length as the channel vector. It contains values of 0 or 1. This parameter controls the behavior at model termination. A value of 1 causes the corresponding channel to be reset to the value specified in the initial value vector. A value of 0 causes the channel to remain at the last value attained while the model was running.

**Initial value vector** — The initial value vector must be the same length as the channel vector and should contain the initial voltage values for the output channels. The channels are set to these values between the time the model is downloaded and the time it is started.

**Sample time** — Enter the base sample time or a multiple of the base sample time.

**PCI Slot (-1:autosearch)** — If only one board of this type is physically present in the target PC, enter

-1

to automatically locate the board.

If two or more boards of this type are physically present in the target PC, enter the bus number and the PCI slot number of the board associated with this driver block. Use the format [BusNumber, SlotNumber]. To determine the bus number and the PCI slot number, type

getxpcpci

## PDXI-MF 16-Bit Series Digital Input

### Scaling Input to Output

| Hardware Input | Block Output Data Type | Scaling                         |
|----------------|------------------------|---------------------------------|
| TTL            | Double                 | TTL low = 0.0<br>TTL high = 1.0 |

### Driver Block Parameters

**Board type** — Select the specific board type from the list provided.

**Channel vector** — Enter a vector of numbers to specify the input channels. For example, to use the first and third digital input channels, enter

[1 3]

The channel numbers can occur in any order. Number the channels beginning with 1 even if the board manufacturer numbers them beginning with 0. The

maximum allowable channel number is 16 for all boards except for the PD2-AO and PDXI-AO series. For those boards, the maximum channel number is 8.

**Sample time** — Enter the base sample time or a multiple of the base sample time.

**PCI Slot (-1:autosearch)** — If only one board of this type is physically present in the target PC, enter

-1

to automatically locate the board.

If two or more boards of this type are physically present in the target PC, enter the bus number and the PCI slot number of the board associated with this driver block. Use the format [BusNumber, SlotNumber]. To determine the bus number and the PCI slot number, type

```
getxpcpci
```

## PDXI-MF 16-Bit Series Digital Output

### Scaling Input to Output

| Hardware Output | Block Input Data Type | Scaling                             |
|-----------------|-----------------------|-------------------------------------|
| TTL             | Double                | < 0.5 = TTL low<br>> 0.5 = TTL high |

### Driver Block Parameters

**Board type** — Select the specific board type from the list provided.

**Channel vector** — Enter a vector of numbers to specify the output channels. For example, to use the first and third digital output channels, enter

```
[1 3]
```

The channel numbers can occur in any order. Number the channels beginning with 1 even if the board manufacturer numbers them beginning with 0. The maximum allowable channel number is 16 for all board types except for the PD2-AO and PDXI-AO series. For those boards, the maximum channel number is 8.

**Reset vector** — The reset vector must be the same length as the channel vector. It contains values of 0 or 1. This parameter controls the behavior at model termination. A value of 1 causes the corresponding channel to be reset to the value specified in the initial value vector. A value of 0 causes the channel to remain at the last value attained while the model was running.

**Initial value vector** — The initial value vector must be the same length as the channel vector. It contains the initial values (0 or 1) for the output channels. The channels are set to these values between the time the model is downloaded and the time it is started.

**Sample time** — Enter the base sample time or a multiple of the base sample time.

**PCI Slot (-1:autosearch)** — If only one board of this type is physically present in the target PC, enter

- 1

to automatically locate the board.

If two or more boards of this type are physically present in the target PC, enter the bus number and the PCI slot number of the board associated with this driver block. Use the format [BusNumber, SlotNumber]. To determine the bus number and the PCI slot number, type

```
getxpcpci
```

## PDXI-MFS 12-Bit Series

The PDXI-MFS 12-bit series contains I/O boards with 4 or 8 single analog input (A/D) channels (12-bit). The boards also have 2 analog output (D/A) channels (12-bit), 16 digital input, and 16 digital output lines. xPC Target does not support the counter/timers on these boards.

xPC Target supports this series of boards with these driver blocks:

- “PDXI-MFS 12-Bit Series Analog Input (A/D)” on page 30-104
- “PDXI-MFS 12-Bit Series Frame Analog Input” on page 30-105
- “PDXI-MFS 12-Bit Series Analog Output (D/A)” on page 30-109
- “PDXI-MFS 12-Bit Series Digital Input” on page 30-110
- “PDXI-MFS 12-Bit Series Digital Output” on page 30-111

### Board Characteristics

|                                 |                                                                                  |
|---------------------------------|----------------------------------------------------------------------------------|
| Board type                      | PDXI-MFS-4-1M/12<br>PDXI-MFS-4-1M/12DG<br>PDXI-MFS-8-1M/12<br>PDXI-MFS-8-1M/12DG |
| Manufacturer                    | United Electronic Industries (UEI)                                               |
| Bus type                        | CompactPCI, PXI                                                                  |
| Access method                   | Memory mapped                                                                    |
| Multiple block instance support | No                                                                               |
| Multiple board support          | Yes                                                                              |

## PDXI-MFS 12-Bit Series Analog Input (A/D)

### Scaling Input to Output

| Hardware Input | Block Output Data Type | Scaling |
|----------------|------------------------|---------|
| volts          | Double                 | 1       |

### Driver Block Parameters

**Board type** — Select the specific board type from the list provided.

**Channel vector** — Enter a vector of numbers to specify the input channels. For example, use the first and third analog input (A/D) channels, enter

[1 3]

The channel numbers can occur in any order. Number the channels beginning with 1 even if the board manufacturer numbers them beginning with 0. The maximum allowable channel number is 4, 8, 16, or 64 depending on the board type.

**Gain vector** — Enter a vector of numbers to select the gains for each of the channels. Available gains vary depending on board type. MF PGL gains may be set to 1, 10, 100, or 1000. MF PGH gains may be set to 1, 2, 4, or 8. MF DG-option gains may be set to 1, 2, 5, or 10.

**Mux settling time factor** — This vector must be the same length as the channel vector. It contains values of 0 or 1. If 1, the corresponding channel has a longer settling time. This is useful when using a high gain such as 100 or 1000.

**Range** — Select the voltage range from the list provided. This applies to all channels.

**Sample time** — Enter the base sample time or a multiple of the base sample time.

**PCI Slot (-1:autosearch)** — If only one board of this type is physically present in the target PC, enter

-1

to automatically locate the board.



If two or more boards of this type are physically present in the target PC, enter the bus number and the PCI slot number of the board associated with this driver block. Use the format [BusNumber, SlotNumber]. To determine the bus number and the PCI slot number, type

```
getxpcpci
```

## PDXI-MFS 12-Bit Series Frame Analog Input

### Scaling Input to Output

| Hardware Input | Block Output Data Type | Scaling |
|----------------|------------------------|---------|
| volts          | Double                 | 1       |

### Driver Block Parameters

**Board type** — Select the specific board type from the list provided.

**Channel vector** — Enter a vector of numbers that make up one scan. For example, to read the first and fifth channels, enter

```
[1 5]
```

The channel numbers can occur in any order. Number the channels beginning with 1 even though the board manufacturer numbers them beginning with 0. The maximum allowable channel number is 4, 8, 16, or 64 depending on the board type.

**Gain vector** — Enter a vector of numbers to specify the gains for each of the channels in the scan. Enter a single value to use the same gain for all vectors in the scan. Available gains vary depending on board type. Allowable values depend on the board type.

- L (Low level) boards — Specify the gain as one of 1, 10, 100, or 1000.
- H (High level) boards — Specify the gain as one of 1, 2, 4, or 8.
- DG-option boards — Specify the gain as one of 1, 2, 5, or 10.

**Mux settling time vector (slow bit)** — Enter a vector that is the same length as the channel vector. Each vector element must be a 0 or 1. If you specify 1, the corresponding channel has a longer settling time. To get an accurate reading, you might want to specify a 1 for channels that have higher gains, such as 100 or 1000. Refer to the UEI PowerDAQ documentation for further information on the longer settling time. This time depends on the board type.

---

**Caution** With frame based acquisition, the additional time needed for the **Mux settling time vector (slow bit)** value might cause an acquisition overrun that xPC Target does not detect. For example, on a PD2-MF-xx-333/16H board, each nonslow acquisition takes 3 microseconds. If the slow bit is set to 1, that same acquisition takes more than 10 microseconds. With xPC Target, the scan is performed at the maximum rate for a given board. This means that the slow acquisition takes a multiple of 3 microsecond ticks. For a PD2-MF-xx-333/16H board, this becomes 12 microseconds.

For example, assume that  $N$  scans of the channel vector compose a frame of data. Assume also that you have a PD2-MF-xx-333/16H board with a **Channel vector** value of [1 2 3 4] and a **Mux settling time vector (slow bit)** value of [0 1 0 1]. For the PD2-MF-xx-333/16H board, two of the of the acquisition delays are 3 microseconds, and two are 12 microseconds. With a **Block sampletime** value of .001 second, if  $N$  is greater than 38, the data will not be acceptable. If you set all slow bits to 0,  $N$  can have a value of up to 83. The software detects the limit at  $N = 83$ , but is not aware of the extra board dependent delay.

---

**Range** — From the list, select one of the following voltage ranges. The value you select applies to all channels.

- +-10 Volts
- +-5 Volts
- 0-10 Volts
- 0-5 Volts

**Frame size** — Enter the number of samples per channel to return as a frame of data. Due to constraints in the hardware architecture, the total number of samples in a frame of data cannot exceed 1024. The relationship between the number of samples, frame size, and number of channels is

$$\text{total number of samples} = \text{FrameSize} \times \text{nChannels}$$

For example, if you specify two channels, the frame size must be less than or equal to 512.

**Output format** — From the list, select either Frame or Vector.

- **Frame** — Select Frame if you expect the output signal from this block to be the input signal for a block that requires a frame. For example, a Signal Processing block.
- **Vector** — Select Vector if you expect the output signal from this block to be the input signal for an xPC Target scope or some other block that requires vector input.

**Scan clock source** — Select Internal or External to identify the clock source for the frame scans.

**Scan time** — Enter the time (in seconds) between scans as the interval.

**Frame time** — Enter the interval (in seconds) during which the board will interrupt. The driver block evenly spaces the scans in the frame across the **Frame time** interval. If the **Frame time** interval is too short, you will receive a buffer overrun error at run time. For optimal results, experimentally increase the **Frame time** value and reiterate the process. Always rebuild the model when you change this value.

The **Frame size**, **Scan time**, and **Frame time** parameters are not independent, but are related by

$$\text{Frametime} = \text{Framesize} \times \text{Scantime}$$

After you specify two of the parameters, specify -1 for the third parameter and the equation determines the third parameter.

---

**Note** Because xPC Target uses this value to set hardware parameters on the board, you cannot change the **Frame time** value at the MATLAB prompt.

---

**Block is in an ISR** — Select this check box if the block is in an interrupt service routine (ISR). Selecting this check box forces the block sample time to -1, which enables the block to work in the ISR. If this check box is not selected, the block sample time is equal to the value of **Frame time**.

**Slave board** — If you have multiple boards configured in a master/slave combination, select this box for the slave boards only. Leave the box unchecked for the master board. (Note that a single board configuration is considered a master board.)

---

**Note** In the model, set the priority of slave blocks higher than master blocks. Right-click the slave or master block and select **Block Properties**. In the dialog, enter a value in the **Priority** property. For example, if you have multiple slave blocks, you can enter values of 2 for the slave blocks and 3 for the master block, where a lower number indicates a higher priority.

---

**Acquisition frequency** — Enter the rate at which the high speed conversion clock runs. This is the clock used to acquire each scan in a frame. For example, with a PD2-MF-xx-333/16H board, the maximum clock is 333 kHz. At that rate, the second channel in a scan will be acquired 3 microseconds after the first one in every scan of the frame.

Specify -1 to select the maximum rate available for the specified board.

**DMA burst size** — From the list, select either 32, 16, or 8. The DMA engine transfers data in packets of the burst size or less. Between each burst, a new bus arbitration cycle must complete. The best performance is achieved with higher **DMA burst size** values, with 32 being highest. However, in some architectures and with some PCI bus adaptors, a **DMA burst size** of 32 might cause problems. For example, it might lock up the target machine when DMA is attempted. In these cases, reduce the **DMA burst size** value to 8, rebuild and rerun the target application. If the DMA works at 8, select 16 to increase performance and try again.

**PCI Slot (-1:autosearch)** — If only one board of this type is physically present in the target PC, enter

-1

to automatically locate the board.

If two or more boards of this type are physically present in the target PC, enter the bus number and the PCI slot number of the board associated with this driver block. Use the format [BusNumber, SlotNumber]. To determine the bus number and the PCI slot number, type

```
getxpcpci
```

## PDXI-MFS 12-Bit Series Analog Output (D/A)

### Scaling Input to Output

| Hardware Output | Block Input Data Type | Scaling |
|-----------------|-----------------------|---------|
| volts           | Double                | 1       |

### Driver Block Parameters

**Board type** — Select the specific board type from the list provided.

**Channel vector** — Enter a vector of numbers to specify the output channels between 1 and 16. For example, to use the first and second analog output (D/A) channels, enter

```
[1 2]
```

The channel numbers can occur in any order. Number the channels beginning with 1 even if the board manufacturer numbers them beginning with 0. The maximum allowable channel number for PD2-AO and PDXI-AO series boards is 8, 16, or 32 depending on the specific board type. For all other boards series the maximum channel number is 2.

**Reset vector** — The reset vector must be the same length as the channel vector. It contains values of 0 or 1. This parameter controls the behavior at model termination. A value of 1 causes the corresponding channel to be reset to the value specified in the initial value vector. A value of 0 causes the channel to remain at the last value attained while the model was running.

**Initial value vector** — The initial value vector must be the same length as the channel vector and should contain the initial voltage values for the output channels. The channels are set to these values between the time the model is downloaded and the time it is started.

**Sample time** — Enter the base sample time or a multiple of the base sample time.

**PCI Slot (-1:autosearch)** — If only one board of this type is physically present in the target PC, enter

-1

to automatically locate the board.

If two or more boards of this type are physically present in the target PC, enter the bus number and the PCI slot number of the board associated with this driver block. Use the format [BusNumber, SlotNumber]. To determine the bus number and the PCI slot number, type

getxpcpci

## PDXI-MFS 12-Bit Series Digital Input

### Scaling Input to Output

| Hardware Input | Block Output Data Type | Scaling                         |
|----------------|------------------------|---------------------------------|
| TTL            | Double                 | TTL low = 0.0<br>TTL high = 1.0 |

### Driver Block Parameters

**Board type** — Select the specific board type from the list provided.

**Channel vector** — Enter a vector of numbers to specify the input channels. For example, to use the first and third digital input channels, enter

[1 3]

The channel numbers can occur in any order. Number the channels beginning with 1 even if the board manufacturer numbers them beginning with 0. The maximum allowable channel number is 16 for all boards except for the PD2-AO and PDXI-AO series. For those boards, the maximum channel number is 8.

**Sample time** — Enter the base sample time or a multiple of the base sample time.

**PCI Slot (-1:autosearch)** — If only one board of this type is physically present in the target PC, enter

-1

to automatically locate the board.

If two or more boards of this type are physically present in the target PC, enter the bus number and the PCI slot number of the board associated with this driver block. Use the format [BusNumber, SlotNumber]. To determine the bus number and the PCI slot number, type

```
getxpcpci
```

## PDXI-MFS 12-Bit Series Digital Output

### Scaling Input to Output

| Hardware Output | Block Input Data Type | Scaling                             |
|-----------------|-----------------------|-------------------------------------|
| TTL             | Double                | < 0.5 = TTL low<br>> 0.5 = TTL high |

### Driver Block Parameters

**Board type** — Select the specific board type from the list provided.

**Channel vector** — Enter a vector of numbers to specify the output channels. For example, to use the first and third digital output channels, enter

```
[1 3]
```

The channel numbers can occur in any order. Number the channels beginning with 1 even if the board manufacturer numbers them beginning with 0. The maximum allowable channel number is 16 for all board types except for the PD2-AO and PDXI-AO series. For those boards, the maximum channel number is 8.

**Reset vector** — The reset vector must be the same length as the channel vector. It contains values of 0 or 1. This parameter controls the behavior at model termination. A value of 1 causes the corresponding channel to be reset

to the value specified in the initial value vector. A value of 0 causes the channel to remain at the last value attained while the model was running.

**Initial value vector** — The initial value vector must be the same length as the channel vector. It contains the initial values (0 or 1) for the output channels. The channels are set to these values between the time the model is downloaded and the time it is started.

**Sample time** — Enter the base sample time or a multiple of the base sample time.

**PCI Slot (-1:autosearch)** — If only one board of this type is physically present in the target PC, enter

- 1

to automatically locate the board.

If two or more boards of this type are physically present in the target PC, enter the bus number and the PCI slot number of the board associated with this driver block. Use the format [BusNumber, SlotNumber]. To determine the bus number and the PCI slot number, type

`getxpcpci`



## **PDXI-MFS 14-Bit Series**

The PDXI-MFS 14-bit series contains I/O boards with 4 or 8 single analog input (A/D) channels (14-bit). The boards also have 2 analog output (D/A) channels (12-bit), 16 digital input, and 16 digital output lines. xPC Target does not support the counter/timers on these boards.

xPC Target supports this series of boards with these driver blocks:

- “PDXI-MFS 14-Bit Series Analog Input (A/D)” on page 30-114
- “PDXI-MFS 14-Bit Series Frame Analog Input” on page 30-116
- “PDXI-MFS 14-Bit Series Analog Output (D/A)” on page 30-120
- “PDXI-MFS 14-Bit Series Digital Input” on page 30-121
- “PDXI-MFS 14-Bit Series Digital Output” on page 30-122

### Board Characteristics

|                                 |                                                                                                                                                                                                                                                                                       |
|---------------------------------|---------------------------------------------------------------------------------------------------------------------------------------------------------------------------------------------------------------------------------------------------------------------------------------|
| Board type                      | PDXI-MFS-4-500/14<br>PDXI-MFS-4-500/14DG<br>PDXI-MFS-8-500/14<br>PDXI-MFS-8-500/14DG<br>PDXI-MFS-4-800/14<br>PDXI-MFS-4-800/14DG<br>PDXI-MFS-8-800/14<br>PDXI-MFS-8-800/14DG<br>PDXI-MFS-4-2M/14<br>PDXI-MFS-4-2M/14DG<br>PDXI-MFS-4-2M/14H<br>PDXI-MFS-8-2M/14<br>PDXI-MFS-8-2M/14DG |
| Manufacturer                    | United Electronic Industries (UEI)                                                                                                                                                                                                                                                    |
| Bus type                        | CompactPCI, PXI                                                                                                                                                                                                                                                                       |
| Access method                   | Memory mapped                                                                                                                                                                                                                                                                         |
| Multiple block instance support | No                                                                                                                                                                                                                                                                                    |
| Multiple board support          | Yes                                                                                                                                                                                                                                                                                   |

### PDXI-MFS 14-Bit Series Analog Input (A/D)

#### Scaling Input to Output

| Hardware Input | Block Output Data Type | Scaling |
|----------------|------------------------|---------|
| volts          | Double                 | 1       |

#### Driver Block Parameters

**Board type** — Select the specific board type from the list provided.

**Channel vector** — Enter a vector of numbers to specify the input channels. For example, use the first and third analog input (A/D) channels, enter

[1 3]

The channel numbers can occur in any order. Number the channels beginning with 1 even if the board manufacturer numbers them beginning with 0. The maximum allowable channel number is 4, 8, 16, or 64 depending on the board type.

**Gain vector** — Enter a vector of numbers to select the gains for each of the channels. Available gains vary depending on board type. MF PGL gains may be set to 1, 10, 100, or 1000. MF PGH gains may be set to 1, 2, 4, or 8. MF DG-option gains may be set to 1, 2, 5, or 10.

**Mux settling time factor** — This vector must be the same length as the channel vector. It contains values of 0 or 1. If 1, the corresponding channel has a longer settling time. This is useful when using a high gain such as 100 or 1000.

**Range** — Select the voltage range from the list provided. This applies to all channels.

**Sample time** — Enter the base sample time or a multiple of the base sample time.

**PCI Slot (-1:autosearch)** — If only one board of this type is physically present in the target PC, enter

-1

to automatically locate the board.

If two or more boards of this type are physically present in the target PC, enter the bus number and the PCI slot number of the board associated with this driver block. Use the format [BusNumber, SlotNumber]. To determine the bus number and the PCI slot number, type

```
getxpcpci
```

## PDXI-MFS 14-Bit Series Frame Analog Input

### Scaling Input to Output

| Hardware Input | Block Output Data Type | Scaling |
|----------------|------------------------|---------|
| volts          | Double                 | 1       |

### Driver Block Parameters

**Board type** — Select the specific board type from the list provided.

**Channel vector** — Enter a vector of numbers that make up one scan. For example, to read the first and fifth channels, enter

[1 5]

The channel numbers can occur in any order. Number the channels beginning with 1 even though the board manufacturer numbers them beginning with 0. The maximum allowable channel number is 4, 8, 16, or 64 depending on the board type.

**Gain vector** — Enter a vector of numbers to specify the gains for each of the channels in the scan. Enter a single value to use the same gain for all vectors in the scan. Available gains vary depending on board type. Allowable values depend on the board type.

- L (Low level) boards — Specify the gain as one of 1, 10, 100, or 1000.
- H (High level) boards — Specify the gain as one of 1, 2, 4, or 8.
- DG-option boards — Specify the gain as one of 1, 2, 5, or 10.

**Mux settling time vector (slow bit)** — Enter a vector that is the same length as the channel vector. Each vector element must be a 0 or 1. If you specify 1, the corresponding channel has a longer settling time. To get an accurate reading, you might want to specify a 1 for channels that have higher gains, such as 100 or 1000. Refer to the UEI PowerDAQ documentation for further information on the longer settling time. This time depends on the board type.

---

**Caution** With frame based acquisition, the additional time needed for the **Mux settling time vector (slow bit)** value might cause an acquisition overrun that xPC Target does not detect. For example, on a PD2-MF-xx-333/16H board, each nonslow acquisition takes 3 microseconds. If the slow bit is set to 1, that same acquisition takes more than 10 microseconds. With xPC Target, the scan is performed at the maximum rate for a given board. This means that the slow acquisition takes a multiple of 3 microsecond ticks. For a PD2-MF-xx-333/16H board, this becomes 12 microseconds.

For example, assume that  $N$  scans of the channel vector compose a frame of data. Assume also that you have a PD2-MF-xx-333/16H board with a **Channel vector** value of [1 2 3 4] and a **Mux settling time vector (slow bit)** value of [0 1 0 1]. For the PD2-MF-xx-333/16H board, two of the of the acquisition delays are 3 microseconds, and two are 12 microseconds. With a **Block sampletime** value of .001 second, if  $N$  is greater than 38, the data will not be acceptable. If you set all slow bits to 0,  $N$  can have a value of up to 83. The software detects the limit at  $N = 83$ , but is not aware of the extra board dependent delay.

---

**Range** — From the list, select one of the following voltage ranges. The value you select applies to all channels.

- +-10 Volts
- +-5 Volts
- 0-10 Volts
- 0-5 Volts

**Frame size** — Enter the number of samples per channel to return as a frame of data. Due to constraints in the hardware architecture, the total number of samples in a frame of data cannot exceed 1024. The relationship between the number of samples, frame size, and number of channels is

$$\text{total number of samples} = \text{FrameSize} \times \text{nChannels}$$

For example, if you specify two channels, the frame size must be less than or equal to 512.

**Output format** — From the list, select either Frame or Vector.

- **Frame** — Select Frame if you expect the output signal from this block to be the input signal for a block that requires a frame. For example, a Signal Processing block.
- **Vector** — Select Vector if you expect the output signal from this block to be the input signal for an xPC Target scope or some other block that requires vector input.

**Scan clock source** — Select Internal or External to identify the clock source for the frame scans.

**Scan time** — Enter the time (in seconds) between scans as the interval.

**Frame time** — Enter the interval (in seconds) during which the board will interrupt. The driver block evenly spaces the scans in the frame across the **Frame time** interval. If the **Frame time** interval is too short, you will receive a buffer overrun error at run time. For optimal results, experimentally increase the **Frame time** value and reiterate the process. Always rebuild the model when you change this value.

The **Frame size**, **Scan time**, and **Frame time** parameters are not independent, but are related by

$$\text{Frame time} = \text{Framesize} \times \text{Scantime}$$

After you specify two of the parameters, specify -1 for the third parameter and the equation determines the third parameter.

---

**Note** Because xPC Target uses this value to set hardware parameters on the board, you cannot change the **Frame time** value at the MATLAB prompt.

---

**Block is in an ISR** — Select this check box if the block is in an interrupt service routine (ISR). Selecting this check box forces the block sample time to -1, which enables the block to work in the ISR. If this check box is not selected, the block sample time is equal to the value of **Frame time**.

**Slave board** — If you have multiple boards configured in a master/slave combination, select this box for the slave boards only. Leave the box unchecked

for the master board. (Note that a single board configuration is considered a master board.)

---

**Note** In the model, set the priority of slave blocks higher than master blocks. Right-click the slave or master block and select **Block Properties**. In the dialog, enter a value in the **Priority** property. For example, if you have multiple slave blocks, you can enter values of 2 for the slave blocks and 3 for the master block, where a lower number indicates a higher priority.

---

**Acquisition frequency** — Enter the rate at which the high speed conversion clock runs. This is the clock used to acquire each scan in a frame. For example, with a PD2-MF-xx-333/16H board, the maximum clock is 333 kHz. At that rate, the second channel in a scan will be acquired 3 microseconds after the first one in every scan of the frame.

Specify -1 to select the maximum rate available for the specified board.

**DMA burst size** — From the list, select either 32, 16, or 8. The DMA engine transfers data in packets of the burst size or less. Between each burst, a new bus arbitration cycle must complete. The best performance is achieved with higher **DMA burst size** values, with 32 being highest. However, in some architectures and with some PCI bus adaptors, a **DMA burst size** of 32 might cause problems. For example, it might lock up the target machine when DMA is attempted. In these cases, reduce the **DMA burst size** value to 8, rebuild and rerun the target application. If the DMA works at 8, select 16 to increase performance and try again.

**PCI Slot (-1:autosearch)** — If only one board of this type is physically present in the target PC, enter

-1

to automatically locate the board.

If two or more boards of this type are physically present in the target PC, enter the bus number and the PCI slot number of the board associated with this driver block. Use the format [BusNumber, SlotNumber]. To determine the bus number and the PCI slot number, type

```
getxpcpci
```

## PDXI-MFS 14-Bit Series Analog Output (D/A)

### Scaling Input to Output

| Hardware Output | Block Input Data Type | Scaling |
|-----------------|-----------------------|---------|
| volts           | Double                | 1       |

### Driver Block Parameters

**Board type** — Select the specific board type from the list provided.

**Channel vector** — Enter a vector of numbers to specify the output channels between 1 and 16. For example, to use the first and second analog output (D/A) channels, enter

[1 2]

The channel numbers can occur in any order. Number the channels beginning with 1 even if the board manufacturer numbers them beginning with 0. The maximum allowable channel number for PD2-AO and PDXI-AO series boards is 8, 16, or 32 depending on the specific board type. For all other boards series the maximum channel number is 2.

**Reset vector** — The reset vector must be the same length as the channel vector. It contains values of 0 or 1. This parameter controls the behavior at model termination. A value of 1 causes the corresponding channel to be reset to the value specified in the initial value vector. A value of 0 causes the channel to remain at the last value attained while the model was running.

**Initial value vector** — The initial value vector must be the same length as the channel vector and should contain the initial voltage values for the output channels. The channels are set to these values between the time the model is downloaded and the time it is started.

**Sample time** — Enter the base sample time or a multiple of the base sample time.

**PCI Slot (-1:autosearch)** — If only one board of this type is physically present in the target PC, enter

-1



to automatically locate the board.

If two or more boards of this type are physically present in the target PC, enter the bus number and the PCI slot number of the board associated with this driver block. Use the format [BusNumber, SlotNumber]. To determine the bus number and the PCI slot number, type

```
getxpcpci
```

## PDXI-MFS 14-Bit Series Digital Input

### Scaling Input to Output

| Hardware Input | Block Output Data Type | Scaling                         |
|----------------|------------------------|---------------------------------|
| TTL            | Double                 | TTL low = 0.0<br>TTL high = 1.0 |

### Driver Block Parameters

**Board type** — Select the specific board type from the list provided.

**Channel vector** — Enter a vector of numbers to specify the input channels. For example, to use the first and third digital input channels, enter

```
[1 3]
```

The channel numbers can occur in any order. Number the channels beginning with 1 even if the board manufacturer numbers them beginning with 0. The maximum allowable channel number is 16 for all boards except for the PD2-AO and PDXI-AO series. For those boards, the maximum channel number is 8.

**Sample time** — Enter the base sample time or a multiple of the base sample time.

**PCI Slot (-1:autosearch)** — If only one board of this type is physically present in the target PC, enter

```
-1
```

to automatically locate the board.

If two or more boards of this type are physically present in the target PC, enter the bus number and the PCI slot number of the board associated with this driver block. Use the format [BusNumber, SlotNumber]. To determine the bus number and the PCI slot number, type

```
getxpcpci
```

## **PDXI-MFS 14-Bit Series Digital Output**

### **Scaling Input to Output**

| <b>Hardware Output</b> | <b>Block Input Data Type</b> | <b>Scaling</b>                      |
|------------------------|------------------------------|-------------------------------------|
| TTL                    | Double                       | < 0.5 = TTL low<br>> 0.5 = TTL high |

### **Driver Block Parameters**

**Board type** — Select the specific board type from the list provided.

**Channel vector** — Enter a vector of numbers to specify the output channels. For example, to use the first and third digital output channels, enter

```
[1 3]
```

The channel numbers can occur in any order. Number the channels beginning with 1 even if the board manufacturer numbers them beginning with 0. The maximum allowable channel number is 16 for all board types except for the PD2-AO and PDXI-AO series. For those boards, the maximum channel number is 8.

**Reset vector** — The reset vector must be the same length as the channel vector. It contains values of 0 or 1. This parameter controls the behavior at model termination. A value of 1 causes the corresponding channel to be reset to the value specified in the initial value vector. A value of 0 causes the channel to remain at the last value attained while the model was running.

**Initial value vector** — The initial value vector must be the same length as the channel vector. It contains the initial values (0 or 1) for the output channels. The channels are set to these values between the time the model is downloaded and the time it is started.

**Sample time** — Enter the base sample time or a multiple of the base sample time.

**PCI Slot (-1:autosearch)** — If only one board of this type is physically present in the target PC, enter

- 1

to automatically locate the board.

If two or more boards of this type are physically present in the target PC, enter the bus number and the PCI slot number of the board associated with this driver block. Use the format [BusNumber, SlotNumber]. To determine the bus number and the PCI slot number, type

```
getxpcpci
```

## PDXI-MFS 16-Bit Series

The PDXI-MFS 16-bit series contains I/O boards with 4 or 8 single analog input (A/D) channels (16-bit). The boards also have 2 analog output (D/A) channels (12-bit), 16 digital input, and 16 digital output lines. xPC Target does not support the counter/timers on these boards.

xPC Target supports this series of boards with these driver blocks:

- “PDXI-MFS 16-Bit Series Analog Input (A/D)” on page 30-125
- “PDXI-MFS 16-Bit Series Frame Analog Input” on page 30-126
- “PDXI-MFS 16-Bit Series Analog Output (D/A)” on page 30-130
- “PDXI-MFS 16-Bit Series Digital Input” on page 30-131
- “PDXI-MFS 16-Bit Series Digital Output” on page 30-132

### Board Characteristics

|                                 |                                                                                                                                                                              |
|---------------------------------|------------------------------------------------------------------------------------------------------------------------------------------------------------------------------|
| Board type                      | PDXI-MFS-4-300/16<br>PDXI-MFS-4-300/16DG<br>PDXI-MFS-8-300/16<br>PDXI-MFS-8-300/16DG<br>PDXI-MFS-4-500/16<br>PDXI-MFS-4-500/16DG<br>PDXI-MFS-8-500/16<br>PDXI-MFS-8-500/16DG |
| Manufacturer                    | United Electronic Industries (UEI)                                                                                                                                           |
| Bus type                        | CompactPCI, PXI                                                                                                                                                              |
| Access method                   | Memory mapped                                                                                                                                                                |
| Multiple block instance support | No                                                                                                                                                                           |
| Multiple board support          | Yes                                                                                                                                                                          |

## PDXI-MFS 16-Bit Series Analog Input (A/D)

### Scaling Input to Output

| Hardware Input | Block Output Data Type | Scaling |
|----------------|------------------------|---------|
| volts          | Double                 | 1       |

### Driver Block Parameters

**Board type** — Select the specific board type from the list provided.

**Channel vector** — Enter a vector of numbers to specify the input channels. For example, use the first and third analog input (A/D) channels, enter

[1 3]

The channel numbers can occur in any order. Number the channels beginning with 1 even if the board manufacturer numbers them beginning with 0. The maximum allowable channel number is 4, 8, 16, or 64 depending on the board type.

**Gain vector** — Enter a vector of numbers to select the gains for each of the channels. Available gains vary depending on board type. MF PGL gains may be set to 1, 10, 100, or 1000. MF PGH gains may be set to 1, 2, 4, or 8. MF DG-option gains may be set to 1, 2, 5, or 10.

**Mux settling time factor** — This vector must be the same length as the channel vector. It contains values of 0 or 1. If 1, the corresponding channel has a longer settling time. This is useful when using a high gain such as 100 or 1000.

**Range** — Select the voltage range from the list provided. This applies to all channels.

**Sample time** — Enter the base sample time or a multiple of the base sample time.

**PCI Slot (-1:autosearch)** — If only one board of this type is physically present in the target PC, enter

-1

to automatically locate the board.

If two or more boards of this type are physically present in the target PC, enter the bus number and the PCI slot number of the board associated with this driver block. Use the format [BusNumber, SlotNumber]. To determine the bus number and the PCI slot number, type

```
getxpcpci
```

## **PDXI-MFS 16-Bit Series Frame Analog Input**

### **Scaling Input to Output**

| <b>Hardware Input</b> | <b>Block Output Data Type</b> | <b>Scaling</b> |
|-----------------------|-------------------------------|----------------|
| volts                 | Double                        | 1              |

### **Driver Block Parameters**

**Board type** — Select the specific board type from the list provided.

**Channel vector** — Enter a vector of numbers that make up one scan. For example, to read the first and fifth channels, enter

```
[1 5]
```

The channel numbers can occur in any order. Number the channels beginning with 1 even though the board manufacturer numbers them beginning with 0. The maximum allowable channel number is 4, 8, 16, or 64 depending on the board type.

**Gain vector** — Enter a vector of numbers to specify the gains for each of the channels in the scan. Enter a single value to use the same gain for all vectors in the scan. Available gains vary depending on board type. Allowable values depend on the board type.

- L (Low level) boards — Specify the gain as one of 1, 10, 100, or 1000.
- H (High level) boards — Specify the gain as one of 1, 2, 4, or 8.
- DG-option boards — Specify the gain as one of 1, 2, 5, or 10.

**Mux settling time vector (slow bit)** — Enter a vector that is the same length as the channel vector. Each vector element must be a 0 or 1. If you specify 1, the corresponding channel has a longer settling time. To get an accurate reading, you might want to specify a 1 for channels that have higher gains, such as 100 or 1000. Refer to the UEI PowerDAQ documentation for further information on the longer settling time. This time depends on the board type.

---

**Caution** With frame based acquisition, the additional time needed for the **Mux settling time vector (slow bit)** value might cause an acquisition overrun that xPC Target does not detect. For example, on a PD2-MF-xx-333/16H board, each nonslow acquisition takes 3 microseconds. If the slow bit is set to 1, that same acquisition takes more than 10 microseconds. With xPC Target, the scan is performed at the maximum rate for a given board. This means that the slow acquisition takes a multiple of 3 microsecond ticks. For a PD2-MF-xx-333/16H board, this becomes 12 microseconds.

For example, assume that  $N$  scans of the channel vector compose a frame of data. Assume also that you have a PD2-MF-xx-333/16H board with a **Channel vector** value of [1 2 3 4] and a **Mux settling time vector (slow bit)** value of [0 1 0 1]. For the PD2-MF-xx-333/16H board, two of the of the acquisition delays are 3 microseconds, and two are 12 microseconds. With a **Block sampletime** value of .001 second, if  $N$  is greater than 38, the data will not be acceptable. If you set all slow bits to 0,  $N$  can have a value of up to 83. The software detects the limit at  $N = 83$ , but is not aware of the extra board dependent delay.

---

**Range** — From the list, select one of the following voltage ranges. The value you select applies to all channels.

- +-10 Volts
- +-5 Volts
- 0-10 Volts
- 0-5 Volts

**Frame size** — Enter the number of samples per channel to return as a frame of data. Due to constraints in the hardware architecture, the total number of samples in a frame of data cannot exceed 1024. The relationship between the number of samples, frame size, and number of channels is

$$\text{total number of samples} = \text{FrameSize} \times \text{nChannels}$$

For example, if you specify two channels, the frame size must be less than or equal to 512.

**Output format** — From the list, select either `Frame` or `Vector`.

- **Frame** — Select `Frame` if you expect the output signal from this block to be the input signal for a block that requires a frame. For example, a `Signal Processing` block.
- **Vector** — Select `Vector` if you expect the output signal from this block to be the input signal for an xPC Target scope or some other block that requires vector input.

**Scan clock source** — Select `Internal` or `External` to identify the clock source for the frame scans.

**Scan time** — Enter the time (in seconds) between scans as the interval.

**Frame time** — Enter the interval (in seconds) during which the board will interrupt. The driver block evenly spaces the scans in the frame across the **Frame time** interval. If the **Frame time** interval is too short, you will receive a buffer overrun error at run time. For optimal results, experimentally increase the **Frame time** value and reiterate the process. Always rebuild the model when you change this value.

The **Frame size**, **Scan time**, and **Frame time** parameters are not independent, but are related by

$$\text{Frametime} = \text{Framesize} \times \text{Scantime}$$

After you specify two of the parameters, specify -1 for the third parameter and the equation determines the third parameter.

---

**Note** Because xPC Target uses this value to set hardware parameters on the board, you cannot change the **Frame time** value at the MATLAB prompt.

---



**Block is in an ISR** — Select this check box if the block is in an interrupt service routine (ISR). Selecting this check box forces the block sample time to -1, which enables the block to work in the ISR. If this check box is not selected, the block sample time is equal to the value of **Frame time**.

**Slave board** — If you have multiple boards configured in a master/slave combination, select this box for the slave boards only. Leave the box unchecked for the master board. (Note that a single board configuration is considered a master board.)

---

**Note** In the model, set the priority of slave blocks higher than master blocks. Right-click the slave or master block and select **Block Properties**. In the dialog, enter a value in the **Priority** property. For example, if you have multiple slave blocks, you can enter values of 2 for the slave blocks and 3 for the master block, where a lower number indicates a higher priority.

---

**Acquisition frequency** — Enter the rate at which the high speed conversion clock runs. This is the clock used to acquire each scan in a frame. For example, with a PD2-MF-xx-333/16H board, the maximum clock is 333 kHz. At that rate, the second channel in a scan will be acquired 3 microseconds after the first one in every scan of the frame.

Specify -1 to select the maximum rate available for the specified board.

**DMA burst size** — From the list, select either 32, 16, or 8. The DMA engine transfers data in packets of the burst size or less. Between each burst, a new bus arbitration cycle must complete. The best performance is achieved with higher **DMA burst size** values, with 32 being highest. However, in some architectures and with some PCI bus adaptors, a **DMA burst size** of 32 might cause problems. For example, it might lock up the target machine when DMA is attempted. In these cases, reduce the **DMA burst size** value to 8, rebuild and rerun the target application. If the DMA works at 8, select 16 to increase performance and try again.

**PCI Slot (-1:autosearch)** — If only one board of this type is physically present in the target PC, enter

-1

to automatically locate the board.

If two or more boards of this type are physically present in the target PC, enter the bus number and the PCI slot number of the board associated with this driver block. Use the format [BusNumber, SlotNumber]. To determine the bus number and the PCI slot number, type

```
getxpcpci
```

## **PDXI-MFS 16-Bit Series Analog Output (D/A)**

### **Scaling Input to Output**

| <b>Hardware Output</b> | <b>Block Input Data Type</b> | <b>Scaling</b> |
|------------------------|------------------------------|----------------|
| volts                  | Double                       | 1              |

### **Driver Block Parameters**

**Board type** — Select the specific board type from the list provided.

**Channel vector** — Enter a vector of numbers to specify the output channels between 1 and 16. For example, to use the first and second analog output (D/A) channels, enter

```
[1 2]
```

The channel numbers can occur in any order. Number the channels beginning with 1 even if the board manufacturer numbers them beginning with 0. The maximum allowable channel number for PD2-AO and PDXI-AO series boards is 8, 16, or 32 depending on the specific board type. For all other boards series the maximum channel number is 2.

**Reset vector** — The reset vector must be the same length as the channel vector. It contains values of 0 or 1. This parameter controls the behavior at model termination. A value of 1 causes the corresponding channel to be reset to the value specified in the initial value vector. A value of 0 causes the channel to remain at the last value attained while the model was running.

**Initial value vector** — The initial value vector must be the same length as the channel vector and should contain the initial voltage values for the output channels. The channels are set to these values between the time the model is downloaded and the time it is started.

**Sample time** — Enter the base sample time or a multiple of the base sample time.

**PCI Slot (-1:autosearch)** — If only one board of this type is physically present in the target PC, enter

-1

to automatically locate the board.

If two or more boards of this type are physically present in the target PC, enter the bus number and the PCI slot number of the board associated with this driver block. Use the format [BusNumber, SlotNumber]. To determine the bus number and the PCI slot number, type

```
getxpcpci
```

## PDXI-MFS 16-Bit Series Digital Input

### Scaling Input to Output

| Hardware Input | Block Output Data Type | Scaling                         |
|----------------|------------------------|---------------------------------|
| TTL            | Double                 | TTL low = 0.0<br>TTL high = 1.0 |

### Driver Block Parameters

**Board type** — Select the specific board type from the list provided.

**Channel vector** — Enter a vector of numbers to specify the input channels. For example, to use the first and third digital input channels, enter

```
[1 3]
```

The channel numbers can occur in any order. Number the channels beginning with 1 even if the board manufacturer numbers them beginning with 0. The maximum allowable channel number is 16 for all boards except for the PD2-AO and PDXI-AO series. For those boards, the maximum channel number is 8.

**Sample time** — Enter the base sample time or a multiple of the base sample time.

**PCI Slot (-1:autosearch)** — If only one board of this type is physically present in the target PC, enter

-1

to automatically locate the board.

If two or more boards of this type are physically present in the target PC, enter the bus number and the PCI slot number of the board associated with this driver block. Use the format [BusNumber, SlotNumber]. To determine the bus number and the PCI slot number, type

getxpcpci

## **PDXI-MFS 16-Bit Series Digital Output**

### **Scaling Input to Output**

| <b>Hardware Output</b> | <b>Block Input Data Type</b> | <b>Scaling</b>                      |
|------------------------|------------------------------|-------------------------------------|
| TTL                    | Double                       | < 0.5 = TTL low<br>> 0.5 = TTL high |

### **Driver Block Parameters**

**Board type** — Select the specific board type from the list provided.

**Channel vector** — Enter a vector of numbers to specify the output channels. For example, to use the first and third digital output channels, enter

[1 3]

The channel numbers can occur in any order. Number the channels beginning with 1 even if the board manufacturer numbers them beginning with 0. The maximum allowable channel number is 16 for all board types except for the PD2-AO and PDXI-AO series. For those boards, the maximum channel number is 8.

**Reset vector** — The reset vector must be the same length as the channel vector. It contains values of 0 or 1. This parameter controls the behavior at model termination. A value of 1 causes the corresponding channel to be reset

to the value specified in the initial value vector. A value of 0 causes the channel to remain at the last value attained while the model was running.

**Initial value vector** — The initial value vector must be the same length as the channel vector. It contains the initial values (0 or 1) for the output channels. The channels are set to these values between the time the model is downloaded and the time it is started.

**Sample time** — Enter the base sample time or a multiple of the base sample time.

**PCI Slot (-1:autosearch)** — If only one board of this type is physically present in the target PC, enter

-1

to automatically locate the board.

If two or more boards of this type are physically present in the target PC, enter the bus number and the PCI slot number of the board associated with this driver block. Use the format [BusNumber, SlotNumber]. To determine the bus number and the PCI slot number, type

```
getxpcpci
```

## PD2-AO Series

The PD2-AO series boards have 8, 16, 32, or 96 analog output (D/A) channels (16-bit) with a maximum sample rate of 100 kHz per channel. They also have 8 digital input and 8 digital output lines.

xPC Target supports this series of boards with these driver blocks:

- “PD2-AO Analog Output (D/A)” on page 30-134
- “PD2-AO Digital Input” on page 30-136
- “PD2-AO Digital Output” on page 30-137

### Board Characteristics

|                                 |                                                             |
|---------------------------------|-------------------------------------------------------------|
| Board type                      | PD2-AO-8/16<br>PD2-AO-16/16<br>PD2-AO-32/16<br>PD2-AO-96/16 |
| Manufacturer                    | United Electronic Industries (UEI)                          |
| Bus type                        | PCI                                                         |
| Access method                   | Memory mapped                                               |
| Multiple block instance support | No                                                          |
| Multiple board support          | Yes                                                         |

### PD2-AO Analog Output (D/A)

#### Scaling Input to Output

| Hardware Output | Block Input Data Type | Scaling |
|-----------------|-----------------------|---------|
| volts           | Double                | 1       |

## Driver Block Parameters

**Board type** — Select the specific board type from the list provided.

**Channel vector** — Enter a vector of numbers to specify the output channels between 1 and 8, 1 and 16, 1 and 32, or 1 and 96. For example, to use the first and second analog output (D/A) channels, enter

```
[ 1 2 ]
```

The channel numbers can occur in any order. Number the channels beginning with 1 even if the board manufacturer numbers them beginning with 0. The maximum allowable channel number for PD2-AO series boards is 8, 16, 32, or 96 depending on the specific board type.

**Reset vector** — The reset vector must be the same length as the channel vector. It contains values of 0 or 1. This parameter controls the behavior at model termination. A value of 1 causes the corresponding channel to be reset to the value specified in the initial value vector. A value of 0 causes the channel to remain at the last value attained while the model was running.

**Initial value vector** — The initial value vector must be the same length as the channel vector and should contain the initial voltage values for the output channels. The channels are set to these values between the time the model is downloaded and the time it is started.

**Sample time** — Enter the base sample time or a multiple of the base sample time.

**PCI Slot (-1:autosearch)** — If only one board of this type is physically present in the target PC, enter

```
- 1
```

to automatically locate the board.

If two or more boards of this type are physically present in the target PC, enter the bus number and the PCI slot number of the board associated with this driver block. Use the format [BusNumber, SlotNumber]. To determine the bus number and the PCI slot number, type

```
getxpcpci
```

## PD2-AO Digital Input

### Scaling Input to Output

| Hardware Input | Block Output Data Type | Scaling                         |
|----------------|------------------------|---------------------------------|
| TTL            | Double                 | TTL low = 0.0<br>TTL high = 1.0 |

### Driver Block Parameters

**Board type** — Select the specific board type from the list provided.

**Channel vector** — Enter a vector of numbers to specify the input channels. For example, to use the first and third digital input channels, enter

[1 3]

The channel numbers can occur in any order. Number the channels beginning with 1 even if the board manufacturer numbers them beginning with 0. The maximum allowable channel number is 16 for all boards except for the PD2-AO and PDXI-AO series. For those boards, the maximum channel number is 8.

**Sample time** — Enter the base sample time or a multiple of the base sample time.

**PCI Slot (-1:autosearch)** — If only one board of this type is physically present in the target PC, enter

-1

to automatically locate the board.

If two or more boards of this type are physically present in the target PC, enter the bus number and the PCI slot number of the board associated with this driver block. Use the format [BusNumber, SlotNumber]. To determine the bus number and the PCI slot number, type

getxpcpci



## PD2-AO Digital Output

### Scaling Input to Output

| Hardware Output | Block Input Data Type | Scaling                             |
|-----------------|-----------------------|-------------------------------------|
| TTL             | Double                | < 0.5 = TTL low<br>> 0.5 = TTL high |

### Driver Block Parameters

**Board type** — Select the specific board type from the list provided.

**Channel vector** — Enter a vector of numbers to specify the output channels. For example, to use the first and third digital output channels, enter

[1 3]

The channel numbers can occur in any order. Number the channels beginning with 1 even if the board manufacturer numbers them beginning with 0. The maximum allowable channel number is 16 for all board types except for the PD2-AO and PDXI-AO series. For those boards, the maximum channel number is 8.

**Reset vector** — The reset vector must be the same length as the channel vector. It contains values of 0 or 1. This parameter controls the behavior at model termination. A value of 1 causes the corresponding channel to be reset to the value specified in the initial value vector. A value of 0 causes the channel to remain at the last value attained while the model was running.

**Initial value vector** — The initial value vector must be the same length as the channel vector. It contains the initial values (0 or 1) for the output channels. The channels are set to these values between the time the model is downloaded and the time it is started.

**Sample time** — Enter the base sample time or a multiple of the base sample time.

**PCI Slot (-1:autosearch)** — If only one board of this type is physically present in the target PC, enter

-1

to automatically locate the board.

If two or more boards of this type are physically present in the target PC, enter the bus number and the PCI slot number of the board associated with this driver block. Use the format [BusNumber, SlotNumber]. To determine the bus number and the PCI slot number, type

`getxpcpci`

## PD2-DIO-64

The PD2-DIO-64 series PCI boards have 64 digital I/O channels in 16-bit ports, three counters/timers, two enhanced synchronous serial interface (ESSI) ports, and four high-speed (100 ns) IRQ lines.

xPC Target supports this series of boards with these driver blocks:

- “PD2-DIO-64 Digital Input” on page 30-140
- “PD2-DIO-64 Digital Output” on page 30-141

xPC Target only supports the digital I/O channels for this board series. It does not support the additional functionality.

### Board Characteristics

|                                 |                                                            |
|---------------------------------|------------------------------------------------------------|
| Board type                      | PD2-DIO-64<br>PD2-DIO-64ST<br>PD2-DIO-64CT<br>PD2-DIO-64TS |
| Manufacturer                    | United Electronic Industries (UEI)                         |
| Bus type                        | PCI                                                        |
| Access method                   | Memory mapped                                              |
| Multiple block instance support | No                                                         |
| Multiple board support          | Yes                                                        |

## PD2-DIO-64 Digital Input

### Scaling Input to Output

| Hardware Input | Block Output Data Type | Scaling                         |
|----------------|------------------------|---------------------------------|
| TTL            | Double                 | TTL low = 0.0<br>TTL high = 1.0 |

### Driver Block Parameters

Note that each block of 16 ports must be input or output.

**Board type** — Select the specific board type from the list provided.

**Port (first channel of port)** — From the list, select the first channel of the port. Each port is 16 bits. This value plus the **Channel vector** value appear on the terminal block.

**Channel vector** — Enter a vector of numbers to specify the input channels. For example, to use the first and third digital input channels, enter

```
[1 3]
```

The channel numbers can occur in any order. Number the channels beginning with 0, which is the same as the hardware label.

**Sample time** — Enter the base sample time or a multiple of the base sample time.

**PCI Slot (-1:autosearch)** — If only one board of this type is physically present in the target PC, enter

```
-1
```

to automatically locate the board.

If two or more boards of this type are physically present in the target PC, enter the bus number and the PCI slot number of the board associated with this driver block. Use the format [BusNumber, SlotNumber]. To determine the bus number and the PCI slot number, type

```
getxpcpci
```

## PD2-DIO-64 Digital Output

### Scaling Input to Output

| Hardware Output | Block Input Data Type | Scaling                             |
|-----------------|-----------------------|-------------------------------------|
| TTL             | Double                | < 0.5 = TTL low<br>> 0.5 = TTL high |

### Driver Block Parameters

**Board type** — Select the specific board type from the list provided.

**Port (first channel of port)** — From the list, select the first channel of the port. Each port is 16 bits. This value and the **Channel vector** value appear on the terminal block.

**Channel vector** — Enter a vector of numbers to specify the output channels. For example, to use the first and third digital output channels, enter

[1 3]

The channel numbers can occur in any order. Number the channels beginning with 0, which is the same as the hardware label.

**Reset vector** — The reset vector controls the behavior of the channel at model termination. Enter a scalar or a vector that is the same length as the channel vector. If you specify a scalar value, that setting is used for all channels. This parameter contains values of 0 or 1. It controls the behavior at model termination. A value of 1 causes the corresponding channel to be reset to the value specified in the initial value vector. A value of 0 causes the channel to remain at the last value attained while the model was running.

**Initial value vector** — The initial value vector contains the initial voltage values for the digital output channels. Enter a scalar or a vector that is the same length as the channel vector. If you specify a scalar value, that setting is used for all channels. This parameter contains the initial values (0 or 1) for the output channels. The channels are set to these values between the time the model is downloaded and the time it is started.

**Sample time** — Enter the base sample time or a multiple of the base sample time.

**PCI Slot (-1:autosearch)** — If only one board of this type is physically present in the target PC, enter

-1

to automatically locate the board.

If two or more boards of this type are physically present in the target PC, enter the bus number and the PCI slot number of the board associated with this driver block. Use the format [BusNumber, SlotNumber]. To determine the bus number and the PCI slot number, type

`getxpcpci`

## PD2-DIO-128

The PD2-DIO-128 series PCI boards have 128 digital I/O channels in 16-bit ports, three counters/timers, two enhanced synchronous serial interface (ESSI) ports, and four high-speed (100 ns) IRQ lines.

xPC Target supports this series of boards with these driver blocks:

- “PD2-DIO-128 Digital Input” on page 30-143
- “PD2-DIO-128 Digital Output” on page 30-144

xPC Target only supports the digital I/O channels for this board series. It does not support the additional functionality.

### Board Characteristics

|                                 |                                    |
|---------------------------------|------------------------------------|
| Board type                      | PD2-DIO-128<br>PD2-DIO-128ST       |
| Manufacturer                    | United Electronic Industries (UEI) |
| Bus type                        | PCI                                |
| Access method                   | Memory mapped                      |
| Multiple block instance support | No                                 |
| Multiple board support          | Yes                                |

### PD2-DIO-128 Digital Input

#### Scaling Input to Output

| Hardware Input | Block Output Data Type | Scaling                         |
|----------------|------------------------|---------------------------------|
| TTL            | Double                 | TTL low = 0.0<br>TTL high = 1.0 |

#### Driver Block Parameters

Note that each block of 16 ports must be input or output.

**Board type** — Select the specific board type from the list provided.

**Port (first channel of port)** — From the list, select the first channel of the port. Each port is 16 bits. This value plus the **Channel vector** value appear on the terminal block.

**Channel vector** — Enter a vector of numbers to specify the input channels. For example, to use the first and third digital input channels, enter

```
[1 3]
```

The channel numbers can occur in any order. Number the channels beginning with 0, which is the same as the hardware label.

**Sample time** — Enter the base sample time or a multiple of the base sample time.

**PCI Slot (-1:autosearch)** — If only one board of this type is physically present in the target PC, enter

```
-1
```

to automatically locate the board.

If two or more boards of this type are physically present in the target PC, enter the bus number and the PCI slot number of the board associated with this driver block. Use the format [BusNumber, SlotNumber]. To determine the bus number and the PCI slot number, type

```
getxpcpci
```

## PD2-DIO-128 Digital Output

### Scaling Input to Output

| Hardware Output | Block Input Data Type | Scaling                             |
|-----------------|-----------------------|-------------------------------------|
| TTL             | Double                | < 0.5 = TTL low<br>> 0.5 = TTL high |

### Driver Block Parameters

**Board type** — Select the specific board type from the list provided.



**Port (first channel of port)** — From the list, select the first channel of the port. Each port is 16 bits. This value and the **Channel vector** value appear on the terminal block.

**Channel vector** — Enter a vector of numbers to specify the output channels. For example, to use the first and third digital output channels, enter

```
[1 3]
```

The channel numbers can occur in any order. Number the channels beginning with 0, which is the same as the hardware label.

**Reset vector** — The reset vector controls the behavior of the channel at model termination. Enter a scalar or a vector that is the same length as the channel vector. If you specify a scalar value, that setting is used for all channels. This parameter contains values of 0 or 1. It controls the behavior at model termination. A value of 1 causes the corresponding channel to be reset to the value specified in the initial value vector. A value of 0 causes the channel to remain at the last value attained while the model was running.

**Initial value vector** — The initial value vector contains the initial voltage values for the digital output channels. Enter a scalar or a vector that is the same length as the channel vector. If you specify a scalar value, that setting is used for all channels. This parameter contains the initial values (0 or 1) for the output channels. The channels are set to these values between the time the model is downloaded and the time it is started.

**Sample time** — Enter the base sample time or a multiple of the base sample time.

**PCI Slot (-1:autosearch)** — If only one board of this type is physically present in the target PC, enter

```
-1
```

to automatically locate the board.

If two or more boards of this type are physically present in the target PC, enter the bus number and the PCI slot number of the board associated with this driver block. Use the format [BusNumber, SlotNumber]. To determine the bus number and the PCI slot number, type

```
getxpcpci
```

## PD2-DIO-128i

The PD2-DIO-128i series PCI boards have 64 optoisolated digital input and 64 optoisolated digital output ports in 16-bit ports.

xPC Target supports this series of boards with these driver blocks:

- “PD2-DIO-128i Digital Input” on page 30-146
- “PD2-DIO-128i Digital Output” on page 30-147

### Board Characteristics

|                                 |                                    |
|---------------------------------|------------------------------------|
| Board type                      | PD2-DIO-128i                       |
| Manufacturer                    | United Electronic Industries (UEI) |
| Bus type                        | PCI                                |
| Access method                   | Memory mapped                      |
| Multiple block instance support | No                                 |
| Multiple board support          | Yes                                |

## PD2-DIO-128i Digital Input

### Scaling Input to Output

| Hardware Input | Block Output Data Type | Scaling                         |
|----------------|------------------------|---------------------------------|
| TTL            | Double                 | TTL low = 0.0<br>TTL high = 1.0 |

### Driver Block Parameters

**Board type** — Select the specific board type from the list provided.

**Port (first channel of port)** — From the list, select the first channel of the port. Each port is 16 bits. This value plus the **Channel vector** value appear on the terminal block.

The input and output ports on the PD2-DIO-128i are completely separate. There is no conflict if you use the same port numbers as input and output.

**Channel vector** — Enter a vector of numbers to specify the input channels. For example, to use the first and third digital input channels, enter

```
[1 3]
```

The channel numbers can occur in any order. Number the channels beginning with 0, which is the same as the hardware label.

**Sample time** — Enter the base sample time or a multiple of the base sample time.

**PCI Slot (-1:autosearch)** — If only one board of this type is physically present in the target PC, enter

```
-1
```

to automatically locate the board.

If two or more boards of this type are physically present in the target PC, enter the bus number and the PCI slot number of the board associated with this driver block. Use the format [BusNumber, SlotNumber]. To determine the bus number and the PCI slot number, type

```
getxpcpci
```

## PD2-DIO-128i Digital Output

### Scaling Input to Output

| Hardware Output | Block Input Data Type | Scaling                             |
|-----------------|-----------------------|-------------------------------------|
| TTL             | Double                | < 0.5 = TTL low<br>> 0.5 = TTL high |

### Driver Block Parameters

**Board type** — Select the specific board type from the list provided.

**Port (first channel of port)** — From the list, select the first channel of the port. Each port is 16 bits. This value and the **Channel vector** value appear on the terminal block.

The input and output ports on the PD2-DIO-128i are completely separate. There is no conflict if you use the same port numbers as input and output.

**Channel vector** — Enter a vector of numbers to specify the output channels. For example, to use the first and third digital output channels, enter

```
[1 3]
```

The channel numbers can occur in any order. Number the channels beginning with 0, which is the same as the hardware label.

**Reset vector** — The reset vector controls the behavior of the channel at model termination. Enter a scalar or a vector that is the same length as the channel vector. If you specify a scalar value, that setting is used for all channels. This parameter contains values of 0 or 1. It controls the behavior at model termination. A value of 1 causes the corresponding channel to be reset to the value specified in the initial value vector. A value of 0 causes the channel to remain at the last value attained while the model was running.

**Initial value vector** — The initial value vector contains the initial voltage values for the digital output channels. Enter a scalar or a vector that is the same length as the channel vector. If you specify a scalar value, that setting is used for all channels. This parameter contains the initial values (0 or 1) for the output channels. The channels are set to these values between the time the model is downloaded and the time it is started.

**Sample time** — Enter the base sample time or a multiple of the base sample time.

**PCI Slot (-1:autosearch)** — If only one board of this type is physically present in the target PC, enter

```
-1
```

to automatically locate the board.

If two or more boards of this type are physically present in the target PC, enter the bus number and the PCI slot number of the board associated with this driver block. Use the format [BusNumber, SlotNumber]. To determine the bus number and the PCI slot number, type

```
getxpcpci
```

## PDL-DIO-64

The PDL-DIO-64 series PCI lab boards have 64 digital I/O channels in 16-bit ports, three counters/timers, two enhanced synchronous serial interface (ESSI) ports, and four high-speed (100 ns) IRQ lines.

xPC Target supports this series of boards with these driver blocks:

- “PDL-DIO-64 Digital Input” on page 30-150
- “PDL-DIO-64 Digital Output” on page 30-151

xPC Target only supports the digital I/O channels for this board series. It does not support the additional functionality.

### Board Characteristics

|                                 |                                                            |
|---------------------------------|------------------------------------------------------------|
| Board type                      | PDL-DIO-64<br>PDL-DIO-64ST<br>PDL-DIO-64CT<br>PDL-DIO-64TS |
| Manufacturer                    | United Electronic Industries (UEI)                         |
| Bus type                        | PCI                                                        |
| Access method                   | Memory mapped                                              |
| Multiple block instance support | No                                                         |
| Multiple board support          | Yes                                                        |

## PDL-DIO-64 Digital Input

### Scaling Input to Output

| Hardware Input | Block Output Data Type | Scaling                         |
|----------------|------------------------|---------------------------------|
| TTL            | Double                 | TTL low = 0.0<br>TTL high = 1.0 |

### Driver Block Parameters

Note that each block of 16 ports must be input or output.

**Board type** — Select the specific board type from the list provided.

**Port (first channel of port)** — From the list, select the first channel of the port. Each port is 16 bits. This value plus the **Channel vector** value appear on the terminal block.

**Channel vector** — Enter a vector of numbers to specify the input channels. For example, to use the first and third digital input channels, enter

```
[1 3]
```

The channel numbers can occur in any order. Number the channels beginning with 0, which is the same as the hardware label.

**Sample time** — Enter the base sample time or a multiple of the base sample time.

**PCI Slot (-1:autosearch)** — If only one board of this type is physically present in the target PC, enter

```
-1
```

to automatically locate the board.

If two or more boards of this type are physically present in the target PC, enter the bus number and the PCI slot number of the board associated with this driver block. Use the format [BusNumber, SlotNumber]. To determine the bus number and the PCI slot number, type

```
getxpcpci
```

## PDL-DIO-64 Digital Output

### Scaling Input to Output

| Hardware Output | Block Input Data Type | Scaling                             |
|-----------------|-----------------------|-------------------------------------|
| TTL             | Double                | < 0.5 = TTL low<br>> 0.5 = TTL high |

### Driver Block Parameters

**Board type** — Select the specific board type from the list provided.

**Port (first channel of port)** — From the list, select the first channel of the port. Each port is 16 bits. This value and the **Channel vector** value appear on the terminal block.

**Channel vector** — Enter a vector of numbers to specify the output channels. For example, to use the first and third digital output channels, enter

[1 3]

The channel numbers can occur in any order. Number the channels beginning with 0, which is the same as the hardware label.

**Reset vector** — The reset vector controls the behavior of the channel at model termination. Enter a scalar or a vector that is the same length as the channel vector. If you specify a scalar value, that setting is used for all channels. This parameter contains values of 0 or 1. It controls the behavior at model termination. A value of 1 causes the corresponding channel to be reset to the value specified in the initial value vector. A value of 0 causes the channel to remain at the last value attained while the model was running.

**Initial value vector** — The initial value vector contains the initial voltage values for the digital output channels. Enter a scalar or a vector that is the same length as the channel vector. If you specify a scalar value, that setting is used for all channels. This parameter contains the initial values (0 or 1) for the output channels. The channels are set to these values between the time the model is downloaded and the time it is started.

**Sample time** — Enter the base sample time or a multiple of the base sample time.

**PCI Slot (-1:autosearch)** — If only one board of this type is physically present in the target PC, enter

-1

to automatically locate the board.

If two or more boards of this type are physically present in the target PC, enter the bus number and the PCI slot number of the board associated with this driver block. Use the format [BusNumber, SlotNumber]. To determine the bus number and the PCI slot number, type

`getxpcpci`



## PDXI-DIO-64

The PDXI-DIO-64 series PXI boards have 64 digital I/O channels in 16-bit ports, three counters/timers, two enhanced synchronous serial interface (ESSI) ports, and four high-speed (100 ns) IRQ lines.

xPC Target supports this series of boards with these driver blocks:

- “PDXI-DIO-64 Digital Input” on page 30-154
- “PDXI-DIO-64 Digital Output” on page 30-155

xPC Target only supports the digital I/O channels for this board series. It does not support the additional functionality.

### Board Characteristics

|                                 |                                                                |
|---------------------------------|----------------------------------------------------------------|
| Board type                      | PDXI-DIO-64<br>PDXI-DIO-64ST<br>PDXI-DIO-64CT<br>PDXI-DIO-64TS |
| Manufacturer                    | United Electronic Industries (UEI)                             |
| Bus type                        | CompactPCI, PXI                                                |
| Access method                   | Memory mapped                                                  |
| Multiple block instance support | No                                                             |
| Multiple board support          | Yes                                                            |

## PDXI-DIO-64 Digital Input

### Scaling Input to Output

| Hardware Input | Block Output Data Type | Scaling                         |
|----------------|------------------------|---------------------------------|
| TTL            | Double                 | TTL low = 0.0<br>TTL high = 1.0 |

### Driver Block Parameters

Note that each block of 16 ports must be input or output.

**Board type** — Select the specific board type from the list provided.

**Port (first channel of port)** — From the list, select the first channel of the port. Each port is 16 bits. This value plus the **Channel vector** value appear on the terminal block.

**Channel vector** — Enter a vector of numbers to specify the input channels. For example, to use the first and third digital input channels, enter

```
[1 3]
```

The channel numbers can occur in any order. Number the channels beginning with 0, which is the same as the hardware label.

**Sample time** — Enter the base sample time or a multiple of the base sample time.

**PCI Slot (-1:autosearch)** — If only one board of this type is physically present in the target PC, enter

```
-1
```

to automatically locate the board.

If two or more boards of this type are physically present in the target PC, enter the bus number and the PCI slot number of the board associated with this driver block. Use the format [BusNumber, SlotNumber]. To determine the bus number and the PCI slot number, type

```
getxpcpci
```

## PDXI-DIO-64 Digital Output

### Scaling Input to Output

| Hardware Output | Block Input Data Type | Scaling                             |
|-----------------|-----------------------|-------------------------------------|
| TTL             | Double                | < 0.5 = TTL low<br>> 0.5 = TTL high |

### Driver Block Parameters

**Board type** — Select the specific board type from the list provided.

**Port (first channel of port)** — From the list, select the first channel of the port. Each port is 16 bits. This value and the **Channel vector** value appear on the terminal block.

**Channel vector** — Enter a vector of numbers to specify the output channels. For example, to use the first and third digital output channels, enter

[1 3]

The channel numbers can occur in any order. Number the channels beginning with 0, which is the same as the hardware label.

**Reset vector** — The reset vector controls the behavior of the channel at model termination. Enter a scalar or a vector that is the same length as the channel vector. If you specify a scalar value, that setting is used for all channels. This parameter contains values of 0 or 1. It controls the behavior at model termination. A value of 1 causes the corresponding channel to be reset to the value specified in the initial value vector. A value of 0 causes the channel to remain at the last value attained while the model was running.

**Initial value vector** — The initial value vector contains the initial voltage values for the digital output channels. Enter a scalar or a vector that is the same length as the channel vector. If you specify a scalar value, that setting is used for all channels. This parameter contains the initial values (0 or 1) for the output channels. The channels are set to these values between the time the model is downloaded and the time it is started.

**Sample time** — Enter the base sample time or a multiple of the base sample time.

**PCI Slot (-1:autosearch)** — If only one board of this type is physically present in the target PC, enter

-1

to automatically locate the board.

If two or more boards of this type are physically present in the target PC, enter the bus number and the PCI slot number of the board associated with this driver block. Use the format [BusNumber, SlotNumber]. To determine the bus number and the PCI slot number, type

`getxpcpci`

## PDXI-AO Series

The PDXI-AO series boards have 8, 16, or 32 analog output (D/A) channels (16 bit) with a maximum sampling rate of 100 kHz per channel. They also have 8 digital input lines, and 8 digital output lines.

xPC Target supports this series of boards with these driver blocks:

- “PDXI-AO Analog Output (D/A)” on page 30-157
- “PDXI-AO Digital Input” on page 30-159
- “PDXI-AO Digital Output” on page 30-160

### Board Characteristics

|                                 |                                                                 |
|---------------------------------|-----------------------------------------------------------------|
| Board type                      | PDXI-AO-8/16<br>PDXI-AO-16/16<br>PDXI-AO-32/16<br>PDXI-AO-96/16 |
| Manufacturer                    | United Electronic Industries (UEI)                              |
| Bus type                        | CompactPCI, PXI                                                 |
| Access method                   | Memory mapped                                                   |
| Multiple block instance support | No                                                              |
| Multiple board support          | Yes                                                             |

## PDXI-AO Analog Output (D/A)

### Scaling Input to Output

| Hardware Output | Block Input Data Type | Scaling |
|-----------------|-----------------------|---------|
| volts           | Double                | 1       |

### Driver Block Parameters

**Board type** — Select the specific board type from the list provided.

**Channel vector** — Enter a vector of numbers to specify the output channels between 1 and 16. For example, to use the first and second analog output (D/A) channels, enter

```
[1 2]
```

The channel numbers can occur in any order. Number the channels beginning with 1 even if the board manufacturer numbers them beginning with 0. The maximum allowable channel number for PD2-AO and PDXI-AO series boards is 8, 16, 32, or 96 depending on the specific board type. For all other boards series the maximum channel number is 2.

**Reset vector** — The reset vector must be the same length as the channel vector. It contains values of 0 or 1. This parameter controls the behavior at model termination. A value of 1 causes the corresponding channel to be reset to the value specified in the initial value vector. A value of 0 causes the channel to remain at the last value attained while the model was running.

**Initial value vector** — The initial value vector must be the same length as the channel vector and should contain the initial voltage values for the output channels. The channels are set to these values between the time the model is downloaded and the time it is started.

**Sample time** — Enter the base sample time or a multiple of the base sample time.

**PCI Slot (-1:autosearch)** — If only one board of this type is physically present in the target PC, enter

```
-1
```

to automatically locate the board.

If two or more boards of this type are physically present in the target PC, enter the bus number and the PCI slot number of the board associated with this driver block. Use the format [BusNumber, SlotNumber]. To determine the bus number and the PCI slot number, type

```
getxpcpci
```

## PDXI-AO Digital Input

### Scaling Input to Output

| Hardware Input | Block Output Data Type | Scaling                         |
|----------------|------------------------|---------------------------------|
| TTL            | Double                 | TTL low = 0.0<br>TTL high = 1.0 |

### Driver Block Parameters

**Board type** — Select the specific board type from the list provided.

**Channel vector** — Enter a vector of numbers to specify the input channels. For example, to use the first and third digital input channels, enter

```
[1 3]
```

The channel numbers can occur in any order. Number the channels beginning with 1 even if the board manufacturer numbers them beginning with 0. The maximum allowable channel number is 16 for all boards except for the PD2-AO and PDXI-AO series. For those boards, the maximum channel number is 8.

**Sample time** — Enter the base sample time or a multiple of the base sample time.

**PCI Slot (-1:autosearch)** — If only one board of this type is physically present in the target PC, enter

```
-1
```

to automatically locate the board.

If two or more boards of this type are physically present in the target PC, enter the bus number and the PCI slot number of the board associated with this driver block. Use the format [BusNumber, SlotNumber]. To determine the bus number and the PCI slot number, type

```
getxpcpci
```

## PDXI-AO Digital Output

### Scaling Input to Output

| Hardware Output | Block Input Data Type | Scaling                             |
|-----------------|-----------------------|-------------------------------------|
| TTL             | Double                | < 0.5 = TTL low<br>> 0.5 = TTL high |

### Driver Block Parameters

**Board type** — Select the specific board type from the list provided.

**Channel vector** — Enter a vector of numbers to specify the output channels. For example, to use the first and third digital output channels, enter

[1 3]

The channel numbers can occur in any order. Number the channels beginning with 1 even if the board manufacturer numbers them beginning with 0. The maximum allowable channel number is 16 for all board types except for the PD2-AO and PDXI-AO series. For those boards, the maximum channel number is 8.

**Reset vector** — The reset vector must be the same length as the channel vector. It contains values of 0 or 1. This parameter controls the behavior at model termination. A value of 1 causes the corresponding channel to be reset to the value specified in the initial value vector. A value of 0 causes the channel to remain at the last value attained while the model was running.

**Initial value vector** — The initial value vector must be the same length as the channel vector. It contains the initial values (0 or 1) for the output channels. The channels are set to these values between the time the model is downloaded and the time it is started.

**Sample time** — Enter the base sample time or a multiple of the base sample time.



**PCI Slot (-1:autosearch)** — If only one board of this type is physically present in the target PC, enter

-1

to automatically locate the board.

If two or more boards of this type are physically present in the target PC, enter the bus number and the PCI slot number of the board associated with this driver block. Use the format [BusNumber, SlotNumber]. To determine the bus number and the PCI slot number, type

`getxpcpci`



# xPC Target Support for Vector CANape

---

xPC Target interfaces the target PC to the Vector CAN Application Environment (CANape) (<http://www.vector-cantech.com>) using the Universal Calibration Protocol (XCP). This chapter includes the following sections

Vector CANape (p. 31-2)

Third-party monitoring system that you can use to work with xPC Target data.

Configuring xPC Target and Vector CANape (p. 31-5)

How to set up the xPC Target system to work Vector CANape.

## Vector CANape

You can use a target PC as an electronic control unit (ECU) for a Vector CANape system. Using a target PC in this way, a Vector CANape system can read signals and parameters from a target application running on the target PC. To support this feature, xPC Target provides an XCP protocol component. The xPC Target XCP component translates XCP commands to standard xPC Target equivalents.

---

**Note** This chapter describes how to configure xPC Target and Vector CANape to work together. It also assumes that you are familiar with the Vector CANape product family. See <http://www.vector-cantech.com> for further information about the Vector CANape products.

---

xPC Target works with Vector CANape, Version 5.00.20 and 5.00.30. To enable a target PC to work with Vector CANape, you need to

- Configure Vector CANape to use the xPC Target XCP communication layer.
- Enable xPC Target to generate a target application that can provide data compliant with Vector CANape.
- Provide a standard RS-232 or TCP/IP physical layer between the host PC and target PC.

To support the XCP communication layer, xPC Target provides

- An xPC Target XCP conversion library (`xcpforxpc.dll`) to convert the XCP commands in the user-defined XCP communication layer to the corresponding xPC Target commands.
- A generator that produces A2L files that Vector CANape can load into the Vector CANape database. The generated file contains signal and parameter access information for the target application.

The following illustrates how xPC Target and Vector CANape interact.

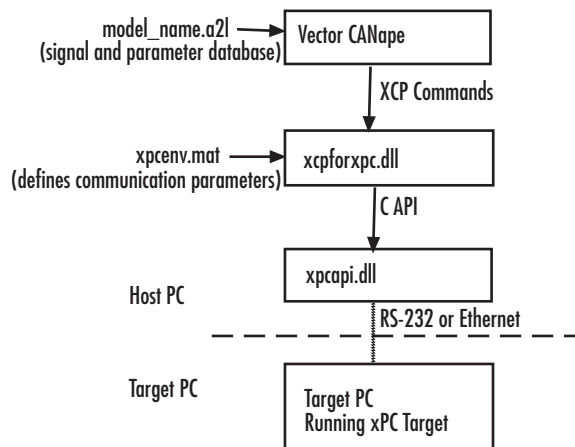

## Notes on xPC Target and Vector CANape

xPC Target does not support the following for Vector CANape:

- Vector CANape data acquisition commands
- Vector CANape calibration commands
- Multiple simultaneous target connections — The network connection to the xPC Target is not shareable (thread-safe). You can only attach it to one program at a time, including
  - Any program that links to the C API library `xpcapi.dll`, such as Vector CANape and any xPC Target demo program
  - The MATLAB command line interface to xPC Target. You can use MATLAB/Simulink while Vector CANape is attached to xPC Target, but you must unload (delete) any xPC Target objects (such as those created with the MATLAB command `xpc`, or implicitly created during code generation).  
To unload any xPC Target objects, type `clear all` in the MATLAB Command Window. Alternatively, to unload xPC Target objects, but keep your workspace variables, type `clear mex` in the MATLAB Command Window.
- Vector CANape signal value selection — You might get an error concerning datatypes. This error message indicates that you need to reapply the value

255 to the parameters **MAX\_CTO** and **MAX\_DTO**. See “Creating a new Vector CANape Project to Associate with a Particular Target Application” on page 31-7.

### **xPC Target Parameters and the A2L File**

During the model build, xPC Target generates an A2L file of signal and parameter information for the Vector CANape database file. A small number of parameter values are common to all target PCs. Other parameter values are for application-wide settings and top-level status information. xPC Target automatically inserts entries for these parameters into the generated A2L file:

- **xAveTET** (Measurement) — Average task execution time (in seconds).
- **xExecutionTime** (Measurement) — Execution time for the target application.
- **xIsOverloaded** (Measurement) — If the target PC experiences an execution overload condition, this value is set to 0. During normal operation, this value is 1.
- **xSampleTime** (Characteristic) — Base sample time (in seconds) of the target application. This can only be modified when the target PC is stopped.
- **xStartStop** (Characteristic) — If the target PC is running, this value is set to 1. If the target PC is halted, this value is set to 0.
- **xStopTime** (Characteristic) — Stop time (in seconds) of the target application. This can only be modified when the target PC is stopped.

## Configuring xPC Target and Vector CANape

To set up xPC Target and Vector CANape, see the following sections:

- “Getting Started” on page 31-5 — Set up your model to work with Vector CANape.
- “Creating a new Vector CANape Project to Associate with a Particular Target Application” on page 31-7 — Create a new Vector CANape and associate that project with a particular target application
- “Associating an Existing Vector CANape Project with a Particular Target PC” on page 31-9 — Associate an existing Vector CANape project with one particular target PC
- “Providing A2L Files for Vector CANape Database” on page 31-10 — Provide target application A2L files for a CANape database

### Getting Started

Set up your model to work with Vector CANape. This procedure uses the `xpcosc` model. This procedure assumes that you have already configured your model to generate xPC Target code. If you have not done so, see the xPC Target getting started documentation.

- 1 In the MATLAB window, type

```
xpcosc
```

- 2 In the model Simulink window, and from the **Simulation** menu, click **Configuration Parameters**.

The Configuration Parameters dialog box is displayed for the model.

- 3 In the left pane, click the **xPC Target options** node.

The associated pane is displayed.

- 4** In the **Miscellaneous options** area, select the **Generate CANape extensions** check box.

This enables target applications to generate data, such as that for A2L, for Vector CANape.

The **Real-Time Workshop** pane should now look like the figure shown.

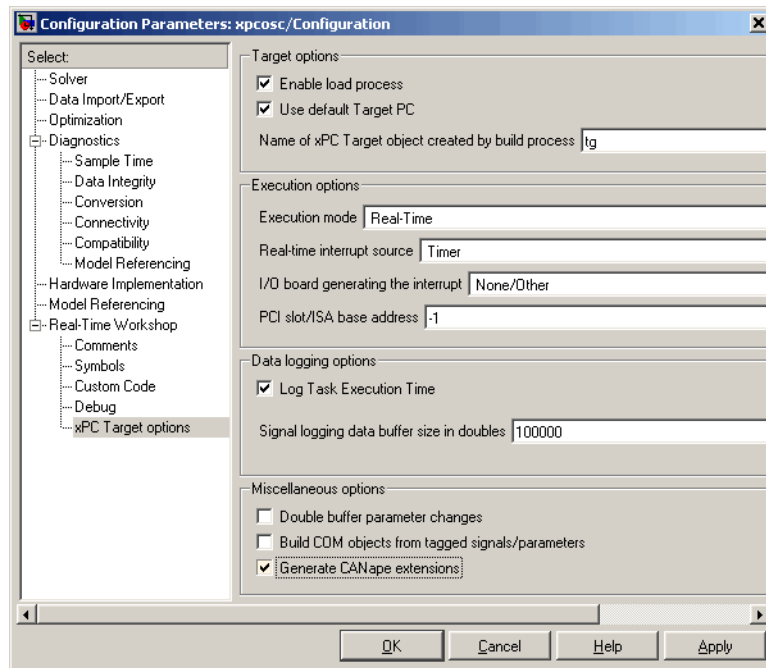

- 5** Build the model.

xPC Target builds the target application, including an A2L data file for the target application.

Next, copy the XCP library files (two) into the CANape binary directory. These files reside in the xPC Target directory area under the MATLAB install location. Follow these instructions:



- 1 Relative to the MATLAB root directory that you found with `matlabroot`, change directory as follows

```
cd <MATLABroot>\toolbox\rtw\targets\xpc\api
```

- 2 Copy `xpcapi.dll` and `xcpforxpc.dll` to the binary directory `Exec` under your Vector CANape install directory. For example if your Vector CANape is installed in `C:\Applications\CANape`, then use the following command line copy commands:

```
copy xpcapi.dll C:\Applications\CANape\Exec  
copy xcpforxpc.dll C:\Applications\CANape\Exec
```

## Creating a new Vector CANape Project to Associate with a Particular Target Application

This procedure describes how to create a new Vector CANape project that can communicate with an xPC Target application. If your xPC Target application is loaded and running during this process, you can test and confirm the communications configuration in step 18.

- 1 In a DOS window, create a new directory to hold your project. This can be the same directory as your xPC Target model files. For example, type  

```
mkdir C:\MyProject
```
- 2 Start the Vector CANape **Create a new Project** wizard. The Windows **Start** menu contains this as a selection in the Vector CANape section.
- 3 After you create the new project, start it.

You can start the new project directly from the last screen of the create a new project wizard. After the preliminary warning, the CANape window is displayed.

- 4 In the CANape window, select **Tools -> Device configuration**.

The device configuration window is displayed.

- 5 In the device configuration window, click **New**.
- 6 In **Device Name**, enter a name for the device to describe your target application. For example, type

xPCTarget

Add any appropriate comments.

**7** Click **Next**

**8** From the driver-type menu list, select **XCP**.

**9** Click **Driver configuration**.

The XCP driver settings window is displayed.

**10** Click **Extended protocol settings**.

**11** In that screen, set

- **MAX\_CTO** and **MAX\_DTO** to 255
- **Byte order** to Intel
- **Address granularity** to BYTE

You might get an error concerning datatypes. This error message indicates that you need to reapply the value 255 to the parameters **MAX\_CTO** and **MAX\_DTO**.

**12** Click **OK**.

The XCP driver settings window is displayed.

**13** In the **Transport layer** pane, from the **Interface** menu list of the, select **USER\_DEFINED**.

**14** In the **Transport layer** pane, click **Configuration**.

**15** Browse and select the file `xcpforxpc.dll` from the `CANape\Exec` directory.

**16** Click **Open**.

**17** Click **OK**.

**18** In the XCP driver settings window, verify the connection to the target PC by clicking **Test connection**. This command only succeeds if the target PC is

running and connected properly. Be sure that no other host is connected to the target PC.

**19** Click **OK** and answer Yes if you are asked to update your database.

**20** You have completed the configuration of Vector CANape for xPC Target. Continue with the rest of the Vector CANape wizard dialog as usual.

This CANape project should now be ready to monitor and control your xPC Target. The CANape database should be populated with a comprehensive list of xPC Target application signals and parameters that are available. During target revisions, it may be necessary to manually reload the A2L that is generated by the xPC Target build process. This can be done from the CANape Database editor.

Next, provide your target application A2L file to Vector CANape. See “Providing A2L Files for Vector CANape Database” on page 31-10. If you want to associate your Vector CANape project with a particular target PC, see “Associating an Existing Vector CANape Project with a Particular Target PC” on page 31-9.

## **Associating an Existing Vector CANape Project with a Particular Target PC**

You might want to force a particular Vector CANape project to use a specific set of communications properties if either of the following situations applies:

- You are working with multiple target PCs from the same host computer.
- You are using a host computer that does not have an installed copy of MATLAB and xPC Target.

This topic assumes that

- You have set up and built your model to generate data for Vector CANape. If you have not yet done so, see “Getting Started” on page 31-5.
- You have an existing Vector CANape project directory

When Vector CANape connects to a target PC, it reads the communications parameters from the last MATLAB session that configured an xPC Target. The XCP layer searches for the xPC Target configuration file (`xpcenv.mat`, a standard MATLAB MAT file). Vector CANape automatically connects to that same target PC.

---

**Note** Clear any MATLAB connections before opening CANape, as described in “Notes on xPC Target and Vector CANape” on page 31-3.

---

- 1 In the MATLAB Command Window, type  
xpcexplr
- 2 Configure the communications protocols as desired for the target PC.
- 3 If the target PC is connected to this computer, test the connection. In the MATLAB Command Window, type xpctargetping and/or xpc.
- 4 If you are satisfied with these settings, copy the xPC Target configuration file to the desired Vector CANape project directory. For example:

```
copy C:\WINNT\Profiles\smith\Application  
Data\MathWorks\MATLAB\R14\xPCTargetPrefs C:\MyProject
```

To retrieve the actual path of xpcenv.mat, you can use the following MATLAB command:

```
[prefdir '\xPCTargetPrefs']
```

The Vector CANape project now has a local copy of xpcenv.mat. It will always connect to the same target PC, regardless of the state of MATLAB. Next, you must provide your target application A2L file to Vector CANape. See “Providing A2L Files for Vector CANape Database” on page 31-10.

## Providing A2L Files for Vector CANape Database

This topic assumes that

- You have set up and built your model to generate data for Vector CANape. If you have not yet done so, see “Getting Started” on page 31-5.
- You have created a Vector CANape project directory and know the name of that project directory.

To enable Vector CANape to load the A2L file for the model xpcosc

- 1 In a DOS shell, change directory to the one that contains the A2L file from the previous procedure. For example

```
cd D:\work\xpc
```

- 2** Look for and copy the A2L file to your Vector CANape project directory. For example

```
copy xpcosc.a2l C:\MyProject
```

Vector CANape automatically loads the target application A2L file when it connects to the target PC.



# Versallogic

---

This chapter describes I/O boards supported by xPC Target (<http://www.versallogic.com>).

VSBC-6 (p. 32-2)

A single board computer with 8 signal ended analog input (A/D) channels, 16 digital I/O lines, and a watchdog timer.

## VSBC-6

The VSBC-6 is a single board computer with 8 signal ended analog input (A/D) channels, 16 digital I/O lines, and a watchdog timer.

xPC Target supports this board with these driver blocks:

- “VSBC-6 Analog Input (A/D)” on page 32-2
- “VSBC-6 Digital Input” on page 32-3
- “VSBC-6 Digital Output” on page 32-4
- “VSBC-6 Watch Dog” on page 32-4

### Board Characteristics

|                                 |             |
|---------------------------------|-------------|
| Board name                      | VSBC-6      |
| Manufacturer                    | Versallogic |
| Bus type                        | N/A         |
| Access method                   | N/A         |
| Multiple block instance support | Yes         |
| Multiple board support          | No          |

### VSBC-6 Analog Input (A/D)

**Channel vector** — Enter numbers between 1 and 8. This driver allows you to enter channel numbers in any order.

For example, to use the first, second and fifth channels, enter

[1,2,5]

Number the channels beginning with 1 even if the board manufacturer starts numbering the channels with 0.

**Range vector** — Enter a range code for each of the channels in the channel vector. The range vector must be the same length as the channel vector. This driver allows each channel to be different.



The following table is a list of the ranges for this driver and the corresponding range codes.

| Input Range (V) | Range Code | Input Range (V) | Range Code |
|-----------------|------------|-----------------|------------|
| -10 to +10      | -10        | 0 to +10        | 10         |
| -5 to +5        | -5         | 0 to +5         | 5          |

For example, if the first channel is -10 to + 10 volts and the second and fifth channels are 0 to +5 volts, enter

[ -10,5,5]

**Sample time** — Model base sample time or a multiple of the base sample time.

## VSBC-6 Digital Input

### Scaling Input to Output

| Hardware Input | Block Output Data Type | Scaling                         |
|----------------|------------------------|---------------------------------|
| TTL            | Double                 | TTL low = 0.0<br>TTL high = 1.0 |

### Driver Block Parameters

**Channel vector** — Enter a numbers between 1 and 16 to select the number of digital input lines used. This driver allows the selection of individual digital input lines in any order.

For example, to use the first, second and fifth digital input lines, enter

[ 1,2,5]

Number the lines beginning with 1, even if the board manufacturer starts numbering the lines with 0.

**Sample time** — Enter the base sample time or a multiple of the base sample time.

## VSBC-6 Digital Output

### Scaling Input to Output

| Hardware Output | Block Input Data Type | Scaling                             |
|-----------------|-----------------------|-------------------------------------|
| TTL             | Double                | < 0.5 = TTL low<br>≥ 0.5 = TTL high |

### Driver Block Parameters

**Channel vector** — Enter numbers between 1 and 16 to select the number of digital output lines used. This driver allows the selection of individual digital output lines in any order.

For example, to use the first, second and fifth digital output lines, enter

[1,2,5]

Number the lines beginning with 1, even if the board manufacturer starts numbering the lines with 0.

**Sample time** — Enter the base sample time or a multiple of the base sample time.

## VSBC-6 Watch Dog

### Block Parameters

**Show enable port** — Select this check box to show a digital input port on the driver block. This port indicates that the watchdog timer is enabled. The watchdog timer starts in a disabled state. If you want to use the VSBC-6 board to reboot the system when a programmable timeout occurs, select this check box.

**Show reset port** — Select this check box to show a digital input port on the driver block. A signal connected to this port resets the watchdog whenever its value exceeds 1.

**Sample time** — Enter the base sample time or a multiple of the base sample time.

# VMIC

---

This chapter describes the VMIC reflective shared memory board supported by xPC Target (<http://www.vmic.com>).

VMICPCI-5565 (p. 33-6)

High-speed fiber optic reflective PCI memory board with 64 or 128 MBytes shared memory

## Before You Start

xPC Target uses a model for reflective memory (also known as shared memory) that includes Simulink blocks, for the shared memory drivers, and MATLAB structures for defining shared memory and node initialization partitions. The topics in this section are

- “Create Shared Memory Partitions” on page 33-2 — Before you begin to use VMIC shared memory blocks, define a partition structure that defines how you want to allocate shared memory.
- “Initialize Shared Memory Nodes” on page 33-4 — Before you begin to use VMIC shared memory blocks, define a node initialization structure that defines how shared memory is allocated (partitioned) and how the board is configured.

### Create Shared Memory Partitions

To use the xPC Target VMICPCI-5565 shared memory blocks to read, write, pack, or unpack data, you must define a partition structure. VMIC shared memory drivers use MATLAB structures to define shared memory partitions. A partition structure describes how you want to allocate (or partition) the shared memory. xPC Target allocates shared memory with bundles of data that are packed into memory partitions. The following VMIC blocks use shared memory partition structures:

- 5565 read/write
- 5565 pack/unpack

After you define the shared memory partitions, you can add VMIC shared memory driver blocks to your Simulink model. Create a shared memory structure in one of the following ways. See “Shared Memory Partition Structure” on page 33-11 for the complete list of fields for the structure.

The following description refers to the `completepartitionstruct` command.  
Type

```
help completepartitionstruct
```

for a description of the command.

- Using the `completepartitionstruct` command at the MATLAB Command Window, create a default partition structure. For example, type

```
completepartitionstruct([], '5565')
```

```
ans =
```

```
    Address: '0x0'  
    Type: 'uint32'  
    Size: '1'  
Alignment: '4'  
Internal: [1x1 struct]
```

- At the MATLAB Command Window, create a user-defined partition structure. The easiest way to do this is to create an M-file, partially define a structure, load that M-file into the MATLAB workspace, and supplement the resulting structure with a call to the `completepartitionstruct` function. For example

```
Partition(1).Address='0x5000';  
Partition(1).Type='int8';  
Partition(1).Size='10';  
Partition(2).Type='uint16';  
Partition(2).Size='5';  
Partition(3).Type='uint8';  
Partition(3).Size='1';  
Partition(3).Alignment='8';  
Partition(4).Type='double';  
Partition(4).Size='3';
```

This example defines a partition with four segments.

- The Address field is optional. Only specify this field for the first segment of a partition. The elements of a partition are defined as a continuous memory block from the first address. The following segments extrapolate their addresses from the first segment. If you have fragmented memory, use multiple partitions and VMIC read/write blocks to work with the memory.
- The Type and Size fields are required for all fields in the partition structure.

- The Alignment value is optional. It is '4' by default, which forces segments that do not have alignment specifications to start on 4 byte (32 bit) boundaries. In this partition, the third segment (Partition(3)) has an alignment of '8'.
- The base addresses of subsequent segments are fully defined by the data type, size, and alignment of the preceding segment.
- You can then call the `completestruct()` command to full populate the partition structure.

## Initialize Shared Memory Nodes

To use the xPC Target VMICPCI-5565 shared memory, you must define a node initialization structure. VMIC shared memory drivers use MATLAB structures to define shared memory node initialization. A node initialization structure describes the shared memory partition (see “Create Shared Memory Partitions” on page 33-2) and the VMIC board configuration, including interrupt configurations. The following VMIC block requires shared memory node initialization structures:

- 5565 init

After you define the node initialization partition, you can add VMIC shared memory driver blocks to your Simulink model. Create a shared memory structure in one of the following ways. See “Shared Memory Node Initialization Structure” on page 33-13 for the complete list of fields for the structure.

The following description refers to the `completenodestruct` command. Type

```
help completenodestruct
```

for a description of the command.

- Using the `completenodestruct` command at the MATLAB Command Window, create a default node initialization structure. For example, type `node=completenodestruct([], '5565')`

```
node =
```

```
    Interface: [1x1 struct]
    Partitions: [1x1 struct]
```

- A user-defined node structure, create with m-code or from the MATLAB Command Window and supplement the resulting structure with a call to the `completenodestruct` function.

## VMICPCI-5565

The VMICPCI-5565 is a high-speed fiber optic reflective memory. It can also generate/broadcast interrupts. xPC Target uses this board as part of the shared memory network that you can use to exchange data between computer nodes.

xPC Target supports this board with these driver blocks:

- “5565 init” on page 33-6
- “5565 read” on page 33-7
- “5565 write” on page 33-8
- “5565 pack” on page 33-9
- “5565 unpack” on page 33-9
- “5565 broadcast” on page 33-9

For information about the Change endianness block, see “Byte Reversal/Change Endianness Block” in Chapter 6.

### Board Characteristics

|                                 |               |
|---------------------------------|---------------|
| Board name                      | VMICPCI-5565  |
| Manufacturer                    | VMIC          |
| Bus type                        | PCI           |
| Access method                   | Memory mapped |
| Multiple block instance support | Yes           |
| Multiple board support          | Yes           |

### 5565 init

#### Driver Block Parameters

Before you begin to configure these block parameters, be sure that you have a predefined node initialization structure. See “Initialize Shared Memory Nodes” on page 33-4.



Each model that uses shared memory must have one 5565 init block for every VMIC board in the system.

**Node struct** — Enter the name of the predefined node initialization structure.

**PCI Slot (-1:autosearch)** — If only one board of this type is physically present in the target PC, enter

-1

to automatically locate the board.

If two or more boards of this type are physically present in the target PC, enter the bus number and the PCI slot number of the board associated with this driver block. Use the format [BusNumber, SlotNumber]. To determine the bus number and the PCI slot number, type

```
getxpcpci
```

## 5565 read

### Driver Block Parameters

Before you begin to configure this block, be sure that you have a predefined shared memory partition structure. The 5565 read block requires this structure to specify how Simulink signal values are mapped in the shared memory. It also uses this structure to determine the total size and address of the shared memory. See “Create Shared Memory Partitions” on page 33-2.

**Partition struct** — Enter the name of the predefined shared memory partition structure. The block uses this structure to specify how Simulink signal values map into shared memory.

**Sampletime** — Enter the base sample time or a multiple of the base sample time.

**PCI Slot (-1:autosearch)** — If only one board of this type is physically present in the target PC, enter

-1

to automatically locate the board.

If two or more boards of this type are physically present in the target PC, enter the bus number and the PCI slot number of the board associated with this driver block. Use the format [BusNumber, SlotNumber]. To determine the bus number and the PCI slot number, type

```
getxpcpci
```

**Error Status Port** — Select this check box to monitor the status of the VMIC board LISR register modes.

## 5565 write

### Driver Block Parameters

Before you begin to configure this block, be sure that you have a predefined shared memory partition structure. The 5565 write block requires this structure to specify how Simulink signal values are mapped in the shared memory. It also uses this structure to determine the total size and address of the shared memory. See “Create Shared Memory Partitions” on page 33-2.

**Partition struct** — Enter the name of the predefined shared memory partition structure. The block uses this structure to specify how Simulink signal values map into shared memory.

**Sampletime** — Enter the base sample time or a multiple of the base sample time.

**PCI Slot (-1:autosearch)** — If only one board of this type is physically present in the target PC, enter

```
-1
```

to automatically locate the board.

If two or more boards of this type are physically present in the target PC, enter the bus number and the PCI slot number of the board associated with this driver block. Use the format [BusNumber, SlotNumber]. To determine the bus number and the PCI slot number, type

```
getxpcpci
```

**Error Status Port** — Select this check box to monitor the status of the VMIC board LISR register modes.

## 5565 pack

Before you begin to configure this block, be sure that you have a predefined shared memory partition structure.

Memory partitions consist of groups of Simulink signals, which are combined into blocks (packets) of 32 bit words. The 5565 pack block packs the specified partition structure into an unstructured double word array vector by converting one or more Simulink signals of varying data types into the vector. Typically, the input to a pack block is the output from a write block. Simulink is not aware of structures; you must pass the output of each structure segment as input to the 5565 pack block.

This block ignores the **Address** field of the partition structure.

### Driver Block Parameters

**Partition struct** — Enter the name of the predefined shared memory partition structure.

## 5565 unpack

Before you begin to configure this block, be sure that you have a predefined shared memory partition structure.

The 5565 unpack block unpacks an unstructured double word array vector (from the 5565 pack block) into the specified partition structure. This block ignores the **Address** field of the partition structure.

### Driver Block Parameters

**Partition struct** — Enter the name of the predefined shared memory partition structure. The block unpacks the double word array vector into this structure.

## 5565 broadcast

The 5565 broadcast block generates a network interrupt that other boards in the shared memory network can detect.

The 5565 broadcast block has two inputs:

- **En** — This input port is a Boolean input that can enable or disable the transmission of a network interrupt. For continuous interrupts, connect this input port to a Constant block with a Boolean value of true (1). If you want

to enable interrupts only part of the time, you can use another kind of input, such as a pulse generator.

- **Data** — This input port allows you to transmit a data value (uint32) with the interrupt. Note that xPC Target does not support receiving this data value.

### Driver Block Parameters

**Target Node** — Enter the node ID of the node to which to broadcast the interrupt. Enter -1 to broadcast the interrupt to all the nodes in the shared memory network. Note that you cannot broadcast the interrupt to any other subset of nodes.

**Interrupt Number** — Enter the VMIC shared IRQ number. This value is the special interrupt number that VMIC boards send between each other (see the LIER register bit descriptions in the VMIC product documentation). This value must match the value of X in a line like the following, which you specify for the receiving end of the shared memory network (see “Board Interrupts” on page 33-16).

```
node.Interface.Interrupts.PendingIntX
```

**Sampletime** — Enter the base sample time or a multiple of the base sample time.

**PCI Slot (-1:autosearch)** — If only one board of this type is physically present in the target PC, enter

```
-1
```

to automatically locate the board.

If two or more boards of this type are physically present in the target PC, enter the bus number and the PCI slot number of the board associated with this driver block. Use the format [BusNumber, SlotNumber]. To determine the bus number and the PCI slot number, type

```
getxpcpci
```

## Shared Memory Structure Reference

You do not need to use all the fields of a partition or node initialization structure. However, knowing the possible structure fields will be helpful when you are creating any of the structures.

This section includes the following topics:

- “Shared Memory Partition Structure” on page 33-11 — Description of the partition node structure fields
- “Shared Memory Node Initialization Structure” on page 33-13 — Description of the node initialization structure fields

### Shared Memory Partition Structure

A shared memory partition structure has the following fields:

```
Address: '0x0'  
Type: 'uint32'  
Size: '1'  
Alignment: '4'  
Internal: [1x1 struct]
```

where:

| <b>Partition Fields</b> | <b>Description</b>                                                                                                                                                                                                                                                                                                                                                                                                                                                     |
|-------------------------|------------------------------------------------------------------------------------------------------------------------------------------------------------------------------------------------------------------------------------------------------------------------------------------------------------------------------------------------------------------------------------------------------------------------------------------------------------------------|
| <b>Address</b>          | <p>Specifies the base address (in hexadecimal) of the memory partition within the node's shared memory space. The default value is '0x0', the first location in shared memory.</p> <p>Align partition addresses on 32-bit word boundaries (for example, 0x0, 0x4, 0x8, and so forth).</p>                                                                                                                                                                              |
| <b>Type</b>             | <p>Specifies the data type of the memory segment. Specify one of the following types:</p> <ul style="list-style-type: none"> <li>• single (IEEE Single Precision)</li> <li>• double (IEEE Double Precision)</li> <li>• uint8</li> <li>• int8</li> <li>• uint16</li> <li>• int16</li> <li>• uint32</li> <li>• int32</li> <li>• Boolean (a single byte represents a boolean value)</li> </ul> <p>The default value is 'uint32'. A minimum partition size is 32 bits.</p> |
| <b>Size</b>             | <p>Specifies the dimension and size of the memory segment. You can enter a scalar value or a value with the [m,n] format. The default value is '1'.</p> <ul style="list-style-type: none"> <li>• scalar — Treats the Size entry as the specification of the length of a non-oriented array or vector</li> <li>• [m,n] — Treats the Size entry as an array dimension. The total number of elements in this segment is m*n.</li> </ul>                                   |

| <b>Partition Fields</b> | <b>Description</b>                                                                                                                                                                                                                                        |
|-------------------------|-----------------------------------------------------------------------------------------------------------------------------------------------------------------------------------------------------------------------------------------------------------|
| <b>Alignment</b>        | If another partition precedes this partition, defines the byte alignment of this segment. Specify one of the following alignment values: 1, 2, 3, 4, or 8. The default value is '4'. This value forces a double word boundary alignment for all elements. |
| <b>Internal</b>         | Reserved for internal use.                                                                                                                                                                                                                                |

## **Shared Memory Node Initialization Structure**

A node initialization structure has the following fields:

Interface: [1x1 struct]  
Partitions: [1x1 struct]

where:

| <b>Node Structure Fields</b> | <b>Description</b>                                                                                                                                                                                                                                                                                                                                                                                                                                                                                                                                     |
|------------------------------|--------------------------------------------------------------------------------------------------------------------------------------------------------------------------------------------------------------------------------------------------------------------------------------------------------------------------------------------------------------------------------------------------------------------------------------------------------------------------------------------------------------------------------------------------------|
| <b>Interface</b>             | <p>Specifies how the board is configured. The Interface structure has the following fields, three of which are structures:</p> <ul style="list-style-type: none"> <li>• Mode — Configures board registers (see “Board Mode”)</li> <li>• Interrupts — Enables the board to generate PCI interrupts from network events that have been broadcast from other nodes, or error conditions (see “Board Interrupts”)</li> <li>• NodeID — Specifies the node ID for the board (see “Board Node ID”)</li> <li>• Internal — Reserved for internal use</li> </ul> |
| <b>Partitions</b>            | Stores the shared memory segments (see “Create Shared Memory Partitions” on page 33-2)                                                                                                                                                                                                                                                                                                                                                                                                                                                                 |

### Board Mode

The VMIC board has a number of registers that you can set through the `Interface.Mode` field. To display the board mode fields, type

```
>> node.Interface.Mode

ans =
      StatusLEDOff: 'off'
      TransmitterDisable: 'off'
      DarkOnDarkEnable: 'off'
      LoopbackEnable: 'off'
      LocalParityEnable: 'off'
      MemoryOffset: '0'
      MemorySize: '64MByte'
```



Note that mode values affect the VMIC board setting of the LSR1 (Local Control and Status Register 1) and LIER (Local Interrupt Enable Register) registers. Refer to the VMIC product documentation for further details on these two registers. To monitor the status of these modes, select the **Error Status Port** check box of the VMIC 5565 read or write block.

Of particular note are the following modes:

| <b>Board Modes</b>  | <b>Description</b>                                                                                                                                                                                                                                                                                                                                   |
|---------------------|------------------------------------------------------------------------------------------------------------------------------------------------------------------------------------------------------------------------------------------------------------------------------------------------------------------------------------------------------|
| <b>StatusLEDOff</b> | Turns the VMIC board status LED on and off. Setting this value to 'off' turns off the LED when the xPC Target model runs, setting this value to 'on' turns on the LED when the xPC Target model runs. When the xPC Target terminates, the LED status reverses in both cases. The default value is 'off'.                                             |
| <b>MemoryOffset</b> | Applies a global offset to all network data transfers coming from the VMIC board. The following table lists offset values and the resulting offset. The default value is '0'.                                                                                                                                                                        |
| <b>MemorySize</b>   | Specifies the minimum memory size required. The VMIC driver checks this value against the memory size of the VMIC board. A VMIC board has a memory size of either '64MByte' or '128MByte'. If you enter a size in this field that is larger than the actual VMIC board memory size, the driver will return an error. The default value is '64MByte'. |

This table lists the values for MemoryOffset:

| <b>Value</b> | <b>Offset Produced</b> |
|--------------|------------------------|
| '0'          | 0                      |
| '1'          | 0x4000000              |

| Value | Offset Produced |
|-------|-----------------|
| '2'   | 0x8000000       |
| '3'   | 0xC000000       |

### Board Interrupts

The VMIC board can generate PCI interrupts in response to network events that have been broadcast from other nodes, or error conditions. For example, you can configure two xPC Target Simulink models, one as master, and one as a slave of the broadcast node in the master xPC Target model. In such a configuration, the broadcast node interrupt triggers the model's time steps.

To display the interrupt mode fields, type

```
>> node.Interface.Interrupts
ans =
    LocalMemoryParity: 'off'
    MemoryWriteInhibited: 'off'
    LatchedSyncLoss: 'off'
    RXFifoFull: 'off'
    RXFifoAlmostFull: 'off'
    BadData: 'off'
    PendingInit: 'off'
    RoguePacket: 'off'
    ResetNodeRequest: 'off'
    PendingInt3: 'off'
    PendingInt2: 'off'
    PendingInt1: 'off'
```

Each field corresponds to a bit in the LIER register of the VMIC board. Each bit enables the specified interrupt source on the VMIC board. Refer to the VMIC product documentation for further details on this register.

To enable a node to generate a network interrupt source, add the 5565 broadcast block to a model (for example, the master model). This block issues network interrupts at the model sample rate. Correspondingly, to enable other nodes of the network (for example, the slaves) to accept broadcast interrupts from the model, configure the slave model to expect the broadcast interrupt.

The following procedure describes how to configure an entire xPC Target model to accept a broadcast interrupt from a VMIC board. See “5565 broadcast” on page 33-9 for a description of the **Interrupt parameter** value that the xPC Target model expects.

- 1 From the MATLAB Command Window, type

```
getxpcpci
```

This command lists board information for all installed PCI devices that xPC Target knows about.

- 2 Find the IRQ specified for the VMIC board.

This is the interrupt source number you need to specify in the **xPC target code generation options** field in step 10 of the following procedure.

- 3 Edit your M-file and add a line like the following.

```
node.Interface.Interrupts.PendingInt1='on'
```

This line directs the model to expect an interrupt. It assumes that the value of the 5565 broadcast block **Interrupt parameter** is 1.

- 4 From the MATLAB Command Window, type the name of your Simulink model.

The Simulink model appears.

- 5 From the **Simulation** menu, click **Simulation Parameters**.

- 6 Click the **Real-Time Workshop** tab.

- 7 From the Category list, choose **xPC Target code generation options**.

- 8 Ensure that the **Execution mode** field is set to Real-Time.

- 9 Click the **Real-Time interrupt source** list.

- 10 Select the interrupt number to which the board is set (from step 2).

- 11 Click the **I/O board generating the interrupt** list and select VMIC-5565 from the list.

12 Click OK.

---

**Note** If you have a larger model, and you want to localize control of the interrupt within that model, use the IRQ Source block from the Asynchronous Event sublibrary.

---

### Board Node ID

The jumpers of the VMIC board specify the board node ID. Correspondingly, you can also configure the VMIC block with the board node ID using the `Interface.NodeID` field. Enter values according to the following:

| <b>NodeID Value</b>     | <b>Description</b>                                                                                                                                                |
|-------------------------|-------------------------------------------------------------------------------------------------------------------------------------------------------------------|
| 'any'                   | Allows the VMIC driver to work with any VMIC node regardless of the VMIC board node ID jumper setting                                                             |
| value from '0' to '255' | Specifies the particular VMIC node that the driver must look for. If this value does not match the jumpered value on the VMIC board, the driver returns an error. |

The default value of 'any' suffices in most instances. However, you might want to specify a particular NodeID value if you have multiple VMIC boards in your system and you want to identify the driver for a particular node.

# Miscellaneous Blocks

---

This chapter describes the miscellaneous blocks supported by xPC Target.

|                                       |                                                                                                                                                             |
|---------------------------------------|-------------------------------------------------------------------------------------------------------------------------------------------------------------|
| xPC Target Scope Block (p. 34-3)      | For information about this block, see “Adding an xPC Target Scope Block” on page 3-16 and “Entering Parameters for an xPC Target Scope Block” on page 3-20. |
| From xPC Target (p. 34-10)            | This block behaves like a source. This block creates and controls an xPC Target scope object running on the target PC.                                      |
| To xPC Target (p. 34-12)              | The main purpose of this block is to write a new value to a specific parameter on the target application while it is running.                               |
| xPC Target From File (p. 34-14)       | Use the xPC Target From File block to read data from a file on the target PC hard disk and distribute that data in chunks every sample time.                |
| xPC Target Software Reboot (p. 34-18) | Use the Software Reboot block to reboot the target PC when your simulation reaches a certain state.                                                         |
| I/O Port Read (p. 34-19)              | To access the address space reserved for I/O devices and communicate directly to a device, xPC Target provides the I/O Port Read and I/O Port Write blocks. |
| I/O Port Write (p. 34-21)             | To access the address space reserved for I/O devices and communicate directly to a device, xPC Target provides the I/O Port Read and I/O Port Write blocks. |
| xPC Target TET (p. 34-23)             | This block outputs the Task Execution Time (TET) in seconds. Use the output of this block as an input to an xPC Target Scope block.                         |

xPC Target Time (p. 34-24)

This block outputs the time in clock ticks that the kernel has been executing.

Asynchronous Event Support (p. 34-25)

xPC Target includes support for asynchronous events. These events are triggered by a hardware interrupt asynchronously to normal execution

## xPC Target Scope Block

For information about this block, see “Adding an xPC Target Scope Block” in Chapter 3 and “Entering Parameters for an xPC Target Scope Block” in Chapter 3 of the xPC Target getting started documentation.

There are three types of scopes, target, host, and file. The xPC Target Scope block dialog changes depending on which scope type you are configuring. The following sections describe the procedure depending on the scope type:

- “xPC Target Scope of Type Target Parameters” on page 34-3
- “xPC Target Scope of Type Host Parameters” on page 34-6
- “xPC Target Scope of Type File Parameters” on page 34-7

### xPC Target Scope of Type Target Parameters

By default, the scope dialog displays the scope of type Target dialog.

**Scope number** — Contains a unique number to identify the scope that is displayed. This number is incremented each time you add a new xPC Target Scope block. Normally, you do not want to edit this value.

This number identifies the xPC Target Scope block and the scope screen on the host or target computer.

**Scope type** — From the list, select Target if it is not already selected.

The updated dialog box displays.

**Start scope when application starts** — Select this check box to start a scope when the target application is downloaded and started. The scope window opens automatically.

**Scope mode** — From the list, select either Numerical, Graphical redraw, Graphical sliding, or Graphical rolling.

If you have a scope type of Target and a scope mode of Numerical, the scope block dialog adds a **Numerical format** box to the dialog. You can define the display format for the data. If you choose not to complete the **Numerical format** box, xPC Target displays the signal using the default format of %15.6f, which is a floating point format, with no label.

**Numerical format** — If you have a scope type of Target and a scope mode of Numerical, the scope block dialog adds a **Numerical format** box to the dialog. Enter a label and associated numeric format type in which to display signals. By default, the entry format is the floating point %15.6f. The **Numerical format** box takes entries of the format:

```
'[LabelN] [%width.precisioctype] [LabelX]'
```

where:

LabelN is the label for the signal. You can use a different label for each signal or the same label for each signal. This argument is optional.

width is the minimum number of characters to offset from the left of the screen or label. This argument is optional.

precision is the maximum number of decimal points for the signal value. This argument is optional.

type is the data type for the signal format. You can use one or more of the following types:

| Type     | Description                                                         |
|----------|---------------------------------------------------------------------|
| %e or %E | Exponential format using e or E                                     |
| %f       | Floating point                                                      |
| %g       | Signed value printed in f or e format depending on which is smaller |
| %G       | Signed value printed in f or E format depending on which is smaller |

LabelX is a second label for the signal. You can use a different label for each signal or the same label for each signal. This argument is optional.

Enclose the contents of the **Numerical format** field in quotation marks.

For example

```
'Foo %15.2f end'
```



For a whole integer signal value, enter 0 for the precision value. For example

```
'Foo1 %15.0f end'
```

For a multiple format entries, delimit each entry with a command and surround the entire string with a pair of quotes. For example

```
'Foo2 %15.6f end,Foo3 %15.6f end2'
```

You can have multiple **Numerical format** entries, separated by a comma. If you enter one entry, that entry applies to each signal (scalar expansion). If you enter fewer label entries than signals, the first entry applies to the first signal, the second entry applies to the second signal, and so forth, and the last entry is scalar expanded for the remaining signals. If you have two entries and one signal, xPC Target ignores the second label entry and applies the first entry. You can enter as many format entries as you have signals for the scope.

**Grid** — Select this check box to display grid lines on the scope. Note that this parameter is only applicable for scopes of type `Target` and scope modes of type `Graphical redraw`, `Graphical sliding`, and `Graphical rolling`.

**Y-Axis limits** — Enter a row vector with two elements where the first element is the lower limit of the *y*-axis and the second element is the upper limit. If you enter 0 for both elements, then the scaling is set to auto. Note that this parameter is only applicable for scopes of type `Target` and scope modes of type `Graphical redraw`, `Graphical sliding`, and `Graphical rolling`.

**Number of samples** — Enter the number of values to be acquired in a data package.

If you select a **Scope mode** of `Graphical redraw`, this parameter specifies the number of values to be acquired before the graph is redrawn.

If you select a **Trigger mode** other than `FreeRun`, this parameter can specify the number of samples to be acquired before the next trigger event.

**Number of pre/post samples** — Enter the number of samples to save or skip. Specify a value less than 0 to save this number of samples before a trigger event. Specify a value greater than 0 to skip this number of samples after the trigger event before data acquisition begins.

**Decimation** — Enter a value to collect data at each sample time (1) or to collect data at less than every sample time (2 or greater).

**Trigger mode** — From the list, select either FreeRun, Software Triggering, Signal Triggering, or Scope Triggering.

If you select FreeRun or Software Triggering, you do not need to specify anything else.

If you select Signal Triggering, then in the **Trigger signal** box, enter the index of a signal. In the **Trigger level** box, enter a value for the signal to cross before triggering. From the **Trigger slope** list, select either, rising, or falling. You do not need to specify the **Trigger scope number**.

If you select Scope Triggering, then in the **Trigger scope number** box, enter the scope number of a Scope block. If you use this trigger mode, you must also add a second Scope block to your Simulink model. You do not need to specify the **Trigger signal**.

If you want the scope to trigger on a specific sample of the other scope, enter a value in the **Sample to trigger on** box. The default value is 0 and indicates that the triggering scope and the triggered (current) scope start simultaneously. For more information on this field, see “Triggering One Scope with Another Scope to Acquire Data” in Chapter 2 in the xPC Target user’s guide documentation.

For additional information on trigger, see “Advanced Data Acquisition Topics” on page 2-11.

## **xPC Target Scope of Type Host Parameters**

By default, the scope dialog displays the scope of type Target dialog.

**Scope number** — Contains a unique number to identify the scope that is displayed. This number is incremented each time you add a new xPC Target scope block. Normally, you do not want to edit this value.

This number identifies the xPC Target Scope block and the scope screen on the host or target computer.

**Scope type** — From the list, select Host.

The updated dialog box is displayed.

**Start scope when application starts** — Select this check box to start a scope when the target application is downloaded and started. With a scope of type target, the scope window opens automatically. With a scope of type host, you can open a host scope viewer window from **xPC Target Explorer**.

**Number of samples** — Enter the number of values to be acquired in a data package.

**Number of pre/post samples** — Enter the number of samples to save or skip. Specify a value less than 0 to save this number of samples before a trigger event. Specify a value greater than 0 to skip this number of samples after the trigger event before data acquisition begins.

**Decimation** — Enter a value to collect data at each sample time (1) or to collect data at less than every sample time (2 or greater).

**Trigger Mode** — From the list, select either FreeRun, Software Triggering, Signal Triggering, or Scope Triggering.

If you select FreeRun or Software Triggering, the trigger event is an automatic one. No other trigger specification is required (see trigger for further details on software trigger).

If you select Signal Triggering, then in the **Trigger signal** box, enter the index of a signal. In the **Trigger level** box, enter a value for the signal to cross before triggering. From the **Trigger slope** list, select either, rising, or falling. You do not need to specify scope triggering.

If you select Scope Triggering, then in the **Trigger scope number** box, enter the scope number of a Scope block. If you use this trigger mode, you must also add a second Scope block to your Simulink model. You do not need to specify signal triggering.

If you want the scope to trigger on a specific sample of the other scope, enter a value in the **Sample to trigger on** box. The default value is 0 and indicates that the triggering scope and the triggered (current) scope start simultaneously. For more information on this field, see “Triggering One Scope with Another Scope to Acquire Data” in Chapter 2 in the xPC Target user’s guide documentation.

## xPC Target Scope of Type File Parameters

By default, the scope dialog displays the scope of type Target dialog.

**Scope number** — Contains a unique number to identify the scope that is displayed. This number increments each time you add a new xPC Target scope block. Normally, you do not want to edit this value.

This number identifies the xPC Target Scope block and the scope screen on the host or target computer.

**Scope type** — From the list, select File.

The updated dialog box is displayed.

**Start scope when application starts** — Select the check box to start a scope when the target application is downloaded and started. The scope window opens automatically.

**Number of samples** — Enter the number of values to be acquired in a data package. This parameter works in conjunction with the **AutoRestart** check box. If the **AutoRestart** box is selected, the scope of type file collects data up to **Number of samples**, then starts over again, overwriting the buffer. If the **AutoRestart** box is not selected, the scope of type file collects data only up to **Number of samples**, then stops.

**Number of pre/post samples** — Enter the number of samples to save or skip. Specify a value less than 0 to save this number of samples before a trigger event. Specify a value greater than 0 to skip this number of samples after the trigger event before data acquisition begins.

**Decimation** — Enter a value to collect data at each sample time (1) or to collect data at less than every sample time (2 or greater).

**Trigger Mode** — From the list, select either FreeRun, Software Triggering, Signal Triggering, or Scope Triggering.

If you select FreeRun or Software Triggering, the trigger event is an automatic one. No external trigger specification is required.

If you select Signal Triggering, then in the **Trigger signal** box, enter the index of a signal. In the **Trigger level** box, enter a value for the signal to cross before triggering. From the **Trigger slope** list, select either, rising, or falling. You do not need to specify scope triggering.

If you select Scope Triggering, then in the **Trigger scope number** box, enter the scope number of a Scope block. If you use this trigger mode, you must also add a second Scope block to your Simulink model. You do not need to specify signal triggering.

If you want the scope to trigger on a specific sample of the other scope, enter a value in the **Sample to trigger on** box. The default value is 0 and indicates that the triggering scope and the triggered (current) scope start simultaneously. For more information on this field, see “Triggering One Scope with Another Scope to Acquire Data” in Chapter 2 in the xPC Target user’s guide documentation.

**Filename** — Enter a name for the file to contain the signal data. By default, the target PC writes the signal data to a file named C:\data.dat.

**Mode** — From the list, select either `Lazy` or `Commit`. Both modes open a file, write signal data to the file, then close that file at the end of the session. With the `Commit` mode, each file write operation simultaneously updates the FAT entry for the file. This mode is slower, but the file system always knows the actual file size. With the `Lazy` mode, the FAT entry is updated only when the file is closed and not during each file write operation. This mode is faster, but if the system crashes before the file is closed, the file system might not know the actual file size (the file contents, however, will be intact).

**WriteSize** — Enter the block size, in bytes, of the data chunks. This parameter specifies that a memory buffer, of length **Number of samples**, writes data to the file in **WriteSize** chunks. By default, this parameter is 512 bytes, which is the typical disk sector size. Using a block size that is the same as the disk sector size provides optimal performance.

**Number of samples** — Enter the number of values to be acquired in a data package.

**AutoRestart** — Select this check box to enable the scope of type file to collect data up to **Number of samples**, then start over again, appending the new data to the end of the signal data file. Clear the **AutoRestart** check box to have the scope of type file collect data up to **Number of samples**, then stop.

## From xPC Target

This block behaves like a source. Its output is usually connected to the input of a display device.

---

**Note** The use of From xPC Target blocks require a connection between the host and target PC. If there is no connection between the host and target PC, operations such as opening a model that contains these blocks or copying these blocks within or between models, will take significantly longer than normal.

---

Some notes on the From xPC Target block behavior

- To highlight a signal line that a From xPC Target block refers to, double-click the From xPC Target block.
- If the From xPC Target block has not yet been configured, double-clicking the From xPC Target block has no effect.
- To edit the From xPC Target block parameters, right-click on the block and select **Mask** parameters.

To run a model that contains From xPC Target blocks, you must

- Configure the Real-Time Workshop parameters **RTW system target file** for the model. Set this value to `xpctarget.tlc`. You access this dialog from the Simulink model **Simulation -> Configuration Parameters** menu. See “Entering the Real-Time Workshop Parameters” on page 3-42 in the xPC Target getting started documentation.
- Specify the correct target PC environment on the **xPC Target options** node of the Real-Time Workshop parameters dialog. In particular, either select the **Use default target PC** check box or enter the target name of the target PC to which you want to connect. If you have only one target PC, the model uses the default target PC and you do not to perform this configuration. See the **Use the default target PC** check box description in “xPC Target Options” on page 3-50 in the xPC Target getting started documentation.

---

**Note** If you have only one target PC, the model uses the default target and you do not perform these configurations.

---

## To xPC Target

This block behaves as a sink. The main purpose of this block is to write a new value to a specific parameter on the target application. This block is implemented as an M-file S-function. The block is optimized so that it only changes a parameter on the target application when the input value differs from the value that existed at the last time step. This block uses the parameter downloading feature of the xPC Target command-line interface.

---

**Note** The use of To xPC Target blocks require a connection between the host and target PC. If there is no connection between the host and target PC, operations such as opening a model that contains these blocks or copying these blocks within or between models, will take significantly longer than normal.

---

Some notes on the To xPC Target block behavior

- To highlight the Simulink model block referenced by a To xPC Target block, double-click the To xPC Target block.
- If the To xPC Target block has not yet been configured, double-clicking the To xPC Target block has no effect.
- To edit the To xPC Target block parameters, right-click on the block and select **Mask** parameters.

Some notes on the From xPC Target block behavior

- To highlight a signal line that a From xPC Target block refers to, double-click the From xPC Target block.
- If the From xPC Target block has not yet been configured, double-clicking the From xPC Target block has no effect.
- To edit the From xPC Target block parameters, right-click on the block and select **Mask** parameters.



To run a model that contains From xPC Target blocks, you must

- Configure the Real-Time Workshop parameters **RTW system target file** for the model. Set this value to `xpctarget.tlc`. You access this dialog from the Simulink model **Simulation -> Configuration Parameters** menu. See “Entering the Real-Time Workshop Parameters” on page 3-42 in the xPC Target getting started documentation.
- Specify the correct target PC environment on the **xPC Target options** node of the Real-Time Workshop parameters dialog. In particular, either select the **Use default target PC** or enter the target name of the target PC to which you want to connect. If you have only one target PC, the model uses the default target PC and you do not to perform this configuration. See the **Use the default target PC** check box description in “xPC Target Options” on page 3-50 in the xPC Target getting started documentation.

---

**Note** If you have only one target PC, the model uses the default target and you do not perform these configurations.

---

## xPC Target From File

The xPC Target From File block reads data from a file on the target PC hard disk and distributes that data in chunks every sample time. As the xPC Target kernel on the target PC reads the file data, it writes that data into a software buffer whose size is user-defined. The From File block then reads the data from this buffer in real time. One example where you might want to use the From File block is if you want to use externally-acquired data (data from a file) to drive a model.

The From File block distributes the data as a sequence of bytes. To use these data bytes as input to a model, convert the data into one or more signals. To do so, use the UDP byte Unpack block. The UDP Unpack block outputs data in various Simulink data types. For example, assume data in your file represents a single precision scalar and a double precision vector of width 3. To convert data of this type, set up the block to output every sample time:

```
28 bytes (1 * sizeof('single') + 3 * sizeof('double'))
```

This can then be converted into the appropriate signals by the Byte Unpacking block.

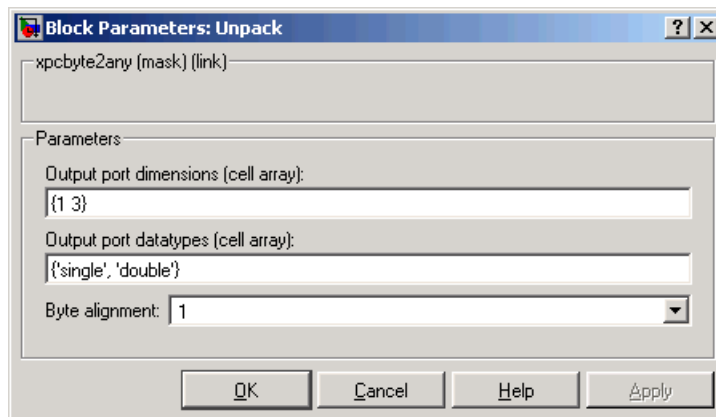

See the following topics:

- “File Format” on page 34-15 — Describes the target PC source file format
- “Block parameters” on page 34-16 — Describes the block parameters for the From File block

## File Format

Before you use a target PC file as the source for the From File block, ensure that the data in the file is formatted properly. The file format is a concatenation of the different data elements for one time step, followed by the next time step, and so on.

For example, assume that the data in your file is the same as that in the preceding example. Assign a variable to each component, for example,

- `a` — single precision value
- `b` — double precision vector of 3

Assume, also, that there are `N` time steps worth of data. The array dimension for `a` and `b` are then

- `size(a)` — `[1, N]`
- `size(b)` — `[3, N]`

In sequence, write out the data like the following to create the file.

```
a(1, 1)    4 bytes
b(:, 1)   24 bytes
a(1, 2)    4 bytes
b(:, 2)   24 bytes
...
...
a(1, N)    4 bytes
b(:, N)   24 bytes
```

If you already have the data as MATLAB variables, use the `xpcbytes2file` function to create the file on the host PC before transferring it to the target PC. This function has the following syntax:

```
xpcbytes2file(filename, var1, ... varn)
```

where

- `filename` — Specify the name of the data file from which the From File block distributes data
- `var1, ... varn` — Specify the column of data to be output to the model.

## Block parameters

**Filename** — Enter the name of the target PC file that contains the data.

**Output port width** — Enter the size, in bytes, of the data to be distributed each sample time.

**Buffer size** — Enter the size of the software FIFO, in bytes. The xPC Target kernel fills this FIFO with the data to be input to the model. The From File block empties this FIFO as it inputs the data to the model.

This parameter should ideally be

- Much larger than **Output port width**
- At least several times the disk read size

If your model has varying Task Execution Times (because of multitasking or because of the use of conditionally executed subsystems), increasing this parameter value helps prevent the real-time application from emptying the buffer faster than the background task can compile it, causing eventual saturation.

**Disk read size** — Enter the number of bytes to read when necessary. To understand this parameter, assume the following default values:

- **Buffer size** is 2000
- **Disk read size** is 512
- **Output port width** is 8

This means that the data buffer is of size 2000. This buffer is initially full.

Each time the block executes, eight bytes are output to the model, and the number of bytes in the buffer decreases by eight. Each time the number of free bytes in the buffer goes to 512 or higher, the xPC Target kernel attempts to read 512 bytes from the xPC Target data file to fill the buffer.

Setting this parameter to another value, for example 1024, causes the From File block to wait until 1024 bytes are free before attempting the next read.

For efficiency, set this value to a multiple of 512 (a disk sector is 512 bytes).

**When reaching EOF** — Select the behavior of the block for when you run the application beyond when you have data in the file. Select

- **Hold last output** — Stops reading and stops the output at the last value
- **Seek to beginning** — Returns to the beginning of the file and starts reading the data (this option results in periodic data)

**Sample time** — Enter a base sample time or a multiple of the base sample time.

## xPC Target Software Reboot

You can use the Software Reboot block to reboot the target PC when your simulation reaches a certain state. For example, if your control system becomes unstable you may want to reboot the target PC.

This block has one input. The input is the reboot signal and accepts the following values:

- 1 — Reboots the target PC.
- 0 — If you use a Software Reboot block and you don't want the target PC to reboot, the input value to this block must be 0.

---

**Note** Not all systems support rebooting from software. You can test whether your system supports a software reboot. From the MATLAB Command Window, enter `xpctest`. For more information, see “Testing the Installation” on page 2-45.

---

### Block parameters

**Sample time** — Enter a base sample time or a multiple of the base sample time.

## I/O Port Read

Intel 80x86 and compatible processors have a special address space reserved for I/O devices. To access this address space and communicate directly to a device, xPC Target provides the I/O Port Read and I/O Port Write blocks. These blocks enable the transfer of data from and to the I/O ports (see also “I/O Port Write” on page 34-21).

- 1 Double click the I/O Port Read block.

The Block Parameters: I/O Port Read dialog box opens.

- 2 In the **I/O-Port address** box, enter the beginning address for each value this block reads.

For example, if you want to read a word (16 bits) starting at I/O port 0x300, followed by a byte (8 bits) at 0x302, enter

```
{ '0x300' , '0x302' }
```

- 3 In the **Data type** box, enter the type for each value this block reads. There is one type for each address you entered in the **I/O-Port address** box.

For example if you want to read a word and then a byte, enter

```
{ 'uint16' , 'uint8' }
```

Your dialog box should look similar to the figure shown below.

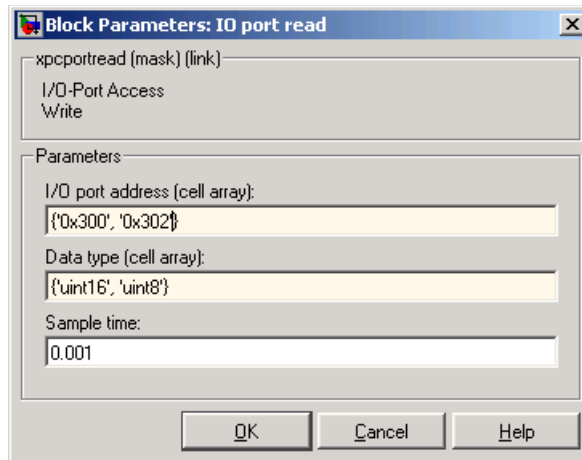

**4 Click OK.**

The number of outputs from the block changes to reflect the length of the I/O-Port address cell array.

| Block Parameters              | Description                                                                                                                                                                                                                                                                                                                             |
|-------------------------------|-----------------------------------------------------------------------------------------------------------------------------------------------------------------------------------------------------------------------------------------------------------------------------------------------------------------------------------------|
| I/O-Port address (cell array) | This is the cell array containing the beginning I/O port addresses for the data you want to read. These addresses are specified in terms of hexadecimal strings.                                                                                                                                                                        |
| Data type (cell array)        | This is the cell array containing the types of data you want to read from I/O port. The <b>Data type</b> cell array has one value for each value in the <b>I/O-Port address</b> cell array.<br><br>The type <code>uint32</code> reads a double word (32 bits), <code>uint16</code> reads a word, and a <code>uint8</code> reads a byte. |
| Sample time                   | Enter a base sample time or a multiple of the base sample time.                                                                                                                                                                                                                                                                         |



## I/O Port Write

Intel 80x86 and compatible processors have a special address space reserved for I/O devices. To access this address space and communicate directly to a device, xPC Target provides the I/O Port Read and I/O Port Write blocks. These blocks enable the transfer of data from and to the I/O ports (see also, “I/O Port Read” on page 34-19).

- 1 Double click the I/O Port Write block.

The Block Parameters: I/O Port Write dialog box opens.

- 2 Enter the parameters.

For example, if you want to write a double word (32 bits) starting at I/O port 0x300, followed by a word (16 bits) at 0x304, enter

```
{ '0x300' , '0x304' }
```

Your dialog box should look similar to the figure shown below.

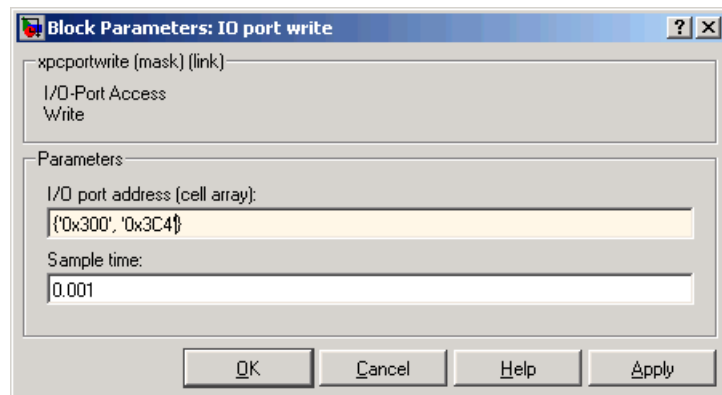

**3 Click OK.**

The number of inputs to the block changes to reflect the length of the I/O-Port address cell array. The data type of the input signal reflects the type of value written to the I/O port. For example, an input signal of type `uint32` writes a double word, an `uint16` input signal writes a word, and an `uint8` input signal writes a byte.

| <b>Block Parameters</b>       | <b>Description</b>                                                                                                                                       |
|-------------------------------|----------------------------------------------------------------------------------------------------------------------------------------------------------|
| I/O-Port address (cell array) | This is the cell array containing the I/O port addresses for the data that you want read. These addresses are specified in terms of hexadecimal strings. |
| Sample time                   | Enter a base sample time or a multiple of the base sample time.                                                                                          |

## **xPC Target TET**

This block outputs the Task Execution Time (TET) in seconds.

Use the output of this block as an input to an xPC Target Scope block. This allows you to visualize the TET while your target application is running.

## **xPC Target Time**

This block outputs the time in clock ticks that the kernel has been executing. This is not the same as the execution time of the target application, but it is the time since you booted up the target PC.

A use for this block is to determine the execution time of subsystems in your Simulink model. Add an xPC Target Time block before and after the subsystem, and then calculate the difference in time.

The time is in clock ticks, and it uses the target PC interval timer to generate the ticks. Since the interval timer runs at a frequency of 1.193 MHz, you can calculate the time in seconds by dividing the output by  $1.193 \times 10^6$ .

## Asynchronous Event Support

xPC Target includes support for asynchronous events. These events are triggered by a hardware interrupt asynchronously to normal execution. Some I/O boards raise interrupts that the CPU can use to interrupt the normal execution of code and jump to another sections of code called an Interrupt Service routine (ISR).

This section includes the following topics:

- “Adding an Asynchronous Event” on page 34-25 — Add an Async IRQ Source block to your Simulink model
- “Async IRQ Source Block” on page 34-28 — Reference for block parameters
- “Async Rate Transition Block” on page 34-29 — Reference for block parameters
- “Async Buffer Write and Read Blocks” on page 34-30 — Reference for block parameters
- “Asynchronous Interrupt Examples” on page 34-31 — Examples for data transfer with a Transition block, buffered data transfer with Real/Write blocks, and interrupt CAN communication with PCI and PC/104 boards

### Adding an Asynchronous Event

When developing a model in Simulink that runs in the xPC Target environment, an Interrupt Server Routine (ISR) is modeled by using a Function-Call Subsystem. Additionally, you need to add an IRQ Source block connected to the Function-Call Subsystem block. This subsystem is then executed when an interrupt occurs and the CPU is ready to accept it.

After you install an I/O board with interrupt support into your target PC, you can add xPC Target asynchronous blocks to your Simulink model.

- 1 In the MATLAB Command Window, type

```
xpclib
```

The xPC Target Library opens.

- 2 Double-click the Asynchronous Event group block.



Asynchronous  
Event

The Library: xpclib/Asynchronous Event window opens.

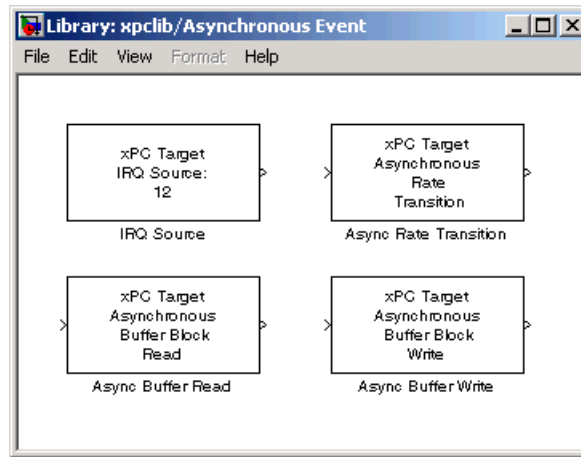

- 3 Drag-and-drop the xPC Target IRQ block in your Simulink model and connect the output to this block to the input of a Function-Call Subsystem. For more information on Function-Call subsystems, see the Simulink and Real-Time Workshop documentation.

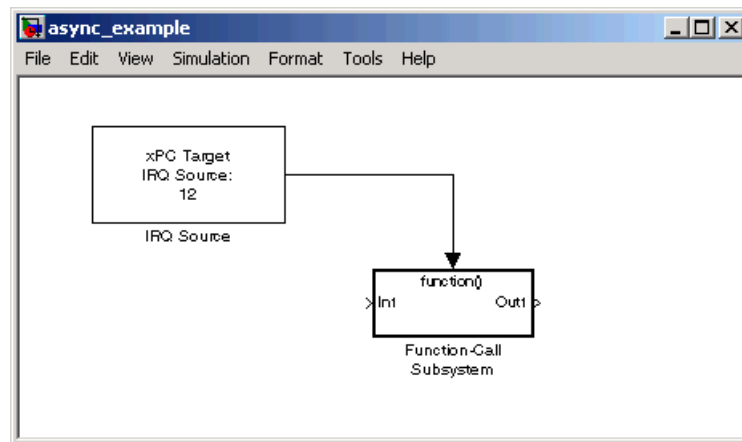

In the setup shown above, the CPU executes the contents of the Function Call-Subsystem whenever IRQ 5 occurs.

- 4 Double-click the IRQ Source block.

The Block Parameters: IRQ Source dialog box opens.

- 5 From the IRQ line number list, choose **1, 2, . . . , 15**. To determine the available IRQ line numbers on the target PC, use the function `getxpcpci`.
- 6 Select or deselect the Allow preemption of function call subsystem check box.
- 7 From the I/O board generating the interrupt list, select an interrupt board.
- 8 In the PCI slot box, enter the PCI slot number or enter -1 to let xPC Target determine the number.
- 9 Click **OK**.

For more information about the IRQ Source block, see “Async IRQ Source Block” on page 34-28.

If you need to transfer data from your ISR, add an Async Transition Block or Async Read/Write blocks to your Simulink model. See “Async Rate Transition Block” on page 34-29, “Async Buffer Write and Read Blocks” on page 34-30, and “Asynchronous Interrupt Examples” on page 34-31.

If you are using a CAN field bus with interrupts, see “Asynchronous Interrupt Examples” on page 34-31.

## Async IRQ Source Block

The main block that notifies Simulink and xPC Target that a particular Function-Call Subsystem should be treated as an ISR is the IRQ Source block. This block is actually a virtual block and does not exist at model execution time. However, the model initialization code sets things up with the CPU to execute the ISR when the proper interrupt occurs.

| Block Parameters                            | Description                                                                                                                                                                                                                                                                                                        |
|---------------------------------------------|--------------------------------------------------------------------------------------------------------------------------------------------------------------------------------------------------------------------------------------------------------------------------------------------------------------------|
| IRQ line number                             | Select the IRQ line number you are using for this block. This depends on the characteristics of your hardware. You may need to query the PCI bus on the target PC to find what IRQ the PCI bus assigned to your hardware. Use the function <code>getxpcpci</code> .<br><br>Valid IRQ numbers are between 3 and 15. |
| Allow preemption of function-call subsystem | Normally, while the ISR is executing, another interrupt will not cause re-execution of the ISR (That is the ISR will not <i>preempt</i> itself). If this check box is checked, the ISR will interrupt itself.                                                                                                      |



| Block Parameters                   | Description                                                                                                                                                                                                                                                                                                                                                                                                                                                                                         |
|------------------------------------|-----------------------------------------------------------------------------------------------------------------------------------------------------------------------------------------------------------------------------------------------------------------------------------------------------------------------------------------------------------------------------------------------------------------------------------------------------------------------------------------------------|
| I/O board generating the interrupt | For many I/O boards, you need to set up the board properly to generate the interrupt. You might also need to set up board specific features at the beginning and/or end of an ISR. Select the correct board that you intend to use from the drop-down list.                                                                                                                                                                                                                                         |
| PCI slot (-1: autosearch)          | <p>If only one board of this type is physically present in the target PC, enter</p> <p style="text-align: center;">- 1</p> <p>to automatically locate the board.</p> <p>If two or more boards of this type are physically present in the target PC, enter the bus number and the PCI slot number of the board associated with this driver block. Use the format [BusNumber, SlotNumber]. To determine the bus number and the PCI slot number, type</p> <p style="text-align: center;">getxpcpci</p> |

## Async Rate Transition Block

Use the Asynchronous Rate Transition block to double buffer data between the function call subsystem and the rest of the model which executes rate-monotonically in real-time.

Normally, the interrupt service routine writes to the first buffer. When the next model step executes, the first buffer is copied to the second buffer and its value is used for model calculations.

If a second interrupt occurs while the buffer is being copied, data is corrupted. This corruption happens when part of the data is copied from the first buffer, the interrupt occurs and writes over the entire first buffer, and then the transition block continues the copy operation from the first buffer that now has data from the second interrupt.

To prevent possible data corruption, use Async Buffer Write and Read blocks. See “Async Buffer Write and Read Blocks” on page 34-30.

| <b>Block Parameters</b> | <b>Description</b>                                              |
|-------------------------|-----------------------------------------------------------------|
| Sample time             | Enter a base sample time or a multiple of the base sample time. |

## **Async Buffer Write and Read Blocks**

These blocks provide double buffering of data between the ISR and the model which executes rate-monotonically in real-time. Always use these blocks in pairs with an Async Buffer Write Block leading into an Async Buffer Read block. The Async Buffer Write Block has to be part of the ISR, and the Async Buffer Read block is outside the ISR.

Use Async Buffer Write and Read blocks for a more secure method of transferring data. Unlike the rate transition block, the data from one buffer is not copied to the second buffer. Instead, interrupts are disabled, and pointers to the buffers are swapped. This method produces the smallest time the interrupts are disabled and protects against data corruption caused by overwriting partially copied buffers.

| <b>Block Parameters</b> | <b>Description</b>                                              |
|-------------------------|-----------------------------------------------------------------|
| Sample time             | Enter a base sample time or a multiple of the base sample time. |

## Asynchronous Interrupt Examples

xPC Target provides several example models. If you installed MATLAB in the default location, these models are located in

```
C:\MATLAB\toolbox\rtw\targets\xpc\xpcdemos
```

To access any of these models, in the MATLAB Command Window, type the name of the model. Each model contain annotations documenting its purpose, and should serve as an example of how to use these blocks.

- `xpcasynbuffer` — Model using an external TTL signal to trigger and interrupt on the PCI-CTR05 board. Data exchange between an asynchronous task and a monotonic task using **Async Buffer Read/Write** blocks.
- `xpcasynctrans` — Model using an external TTL signal to trigger and interrupt. on the PCI-CTR05 board. Data exchange between and asynchronous task and a rate monotonic task using a **Async Rate Transition** block.
- `xpccanintpc104` — Model using interrupt driven CAN I/O communication with the CAN-AC2-104 board.
- `xpccanintpci` — Model using interrupt driven CAN I/O communication with the CAN-AC2-PCI board.



# Obsoleted Drivers

---

xPC Target has obsoleted some or all the drivers for the following manufacturers:

xPC Target Library of Obsoleted  
Drivers (p. 35-2)

Library of obsoleted I/O drivers

Burr-Brown (p. 35-3)

Obsoleted I/O drivers from Burr-Brown

Gespac (p. 35-15)

Obsoleted I/O drivers from Gespac

“Measurement Computing (Computer  
Boards)” on page 35-20

Obsoleted I/O drivers from Measurement Computing

## xPC Target Library of Obsoleted Drivers

You can still access obsoleted driver blocks by typing the following command at the MATLAB Command Window.

```
xpcobsoletelib
```

Existing models that use these drivers will still work. However, their presence is not guaranteed for future releases. Do not use these driver blocks in new models.

In addition, in the xPC Target library (`xpc1lib`), there are new versions of the following Measurement Computing Incremental Encoder drivers. Please use the new version of these drivers.

- CIO-QUAD02
- CIO-QUAD04
- PCI-QUAD04

To access the previous versions of these drivers, use the `xpcobsoletelib` command. The presence of the obsoleted versions of these drivers is not guaranteed for future releases.

## Burr-Brown

I/O boards supported by xPC Target (<http://www.instrument.com/pci>).

### PCI-20003M

The PCI-20003M is an I/O board with two analog output (D/A) channels (12-bit).

xPC Target supports this board when it is installed on a PCI-20041C carrier board with this driver block:

- “PCI-20003M Analog Output (D/A)” on page 35-3

#### Board Characteristics

|                                 |               |
|---------------------------------|---------------|
| Board name                      | PCI-20003M    |
| Manufacturer                    | Burr-Brown    |
| Bus type                        | ISA           |
| Access method                   | Memory mapped |
| Multiple block instance support | No            |
| Multiple board support          | Yes           |

#### PCI-20003M Analog Output (D/A)

Scaling Input to Output.

| Hardware Output | Block Input Data Type | Scaling |
|-----------------|-----------------------|---------|
| volts           | Double                | 1       |

#### Driver Block Parameters.

**Channel vector** — This parameter is a combined Channel vector and Range vector. The number of elements defines the number of A/D channels used.

Enter a range code for each of the A/D channels used. This driver allows a different range for each channel with a maximum of two A/D channels.

The following table is a list of the ranges for this driver and the corresponding range codes.

| Input Range (V) | Range Code | Input Range (V) | Range Code |
|-----------------|------------|-----------------|------------|
| -10 to +10      | -10        | 0 - 10          | 10         |
|                 |            | 0 - 5           | 5          |

For example, if the first channel is -10 to + 10 volts and the second channel is 0 to +5 volts, enter

[ - 10, 5 ]

The jumpers W1 to W5, W13, W14, W27, W31, W7 to W11, W30, W32 on the module must correspond to this range setting.

**Sample Time** — Enter the base sample time or a multiple of the base sample time.

**Module Number** — Enter a number from 1 to 3 to identify the connector on the carrier board where the I/O module is inserted. This driver verifies if the module is placed on the specified module connector.

**Base Address or Carrier Board (ie: 0xd000)** — Enter the base address of the board. This entry must correspond to the DIP-switch settings on the board. For example, if the base address is 300 (hexadecimal), enter

0x300

## PCI-20019M

The PCI-20019M is an I/O board with 8 single analog input (A/D) channels (12-bit).

xPC Target supports this board when it is installed on a PCI-20041C carrier board with this driver block:

- “PCI-20019M Analog Input (A/D)” on page 35-5



## Board Characteristics

|                                 |               |
|---------------------------------|---------------|
| Board name                      | PCI-20019M    |
| Manufacturer                    | Burr-Brown    |
| Bus type                        | ISA           |
| Access method                   | Memory mapped |
| Multiple block instance support | No            |
| Multiple board support          | Yes           |

## PCI-20019M Analog Input (A/D)

### Scaling Input to Output.

| Hardware Input | Block Output Data Type | Scaling |
|----------------|------------------------|---------|
| volts          | Double                 | 1       |

### Driver Block Parameters.

**Number of Channels** — Enter a number between 1 and 8 to select the number of A/D channels used. This driver does not allow the selection of individual channels.

Number the channels beginning with 1 even if the board manufacturer starts numbering the channels with 0.

**Input Range** — Enter an input range code for all A/D channels. This driver does not allow the selection of a different range for individual channel. The input range is the same for all A/D channels

The following table is a list of the ranges for this driver and the corresponding range codes.

| Input Range (V) | Range Code | Input Range (V) | Range Code |
|-----------------|------------|-----------------|------------|
| -10 to +10      | -10        | 0 - 10          | 10         |
| -5 to +5        | -5         | 0 - 5           | 5          |
| -2.5 to +2.5    | -2.5       |                 |            |

The jumpers W1 to W5 on the module must correspond to this range setting.

**Sample time** — Enter a base sample time or a multiple of the base sample time.

**Module Number (1-3)** — Enter a number from 1 to 3 to identify the connector on the carrier board where the I/O module is inserted. This driver verifies if the module is placed on the specified module connector.

**Base Address of Carrier Board (ie. 0xd000)** — Enter the base address of the board. This entry must correspond to the DIP-switch settings on the board. For example, if the base address is 300 (hexadecimal), enter

0x300

Other jumper on this board. The switch and jumper settings, that are not mentioned here, have no influence on the running of xPC Target.

| Jumper Number | Jumper | Jumper Number | Jumper |
|---------------|--------|---------------|--------|
| W6            | out    | W22           | out    |
| W8            | in     | W27           | out    |
| W10           | out    | W30           | -      |
| W11           | in     | W31           | -      |
| W12           | out    |               |        |

## PCI-20023M

The PCI-20023M is an I/O board with 8 single analog input (A/D) channels (12-bit).

xPC Target supports this board when it is installed on a PCI-20041C carrier board with this driver block:

- “PCI-20023M Analog Input (A/D)” on page 35-7

### Board Characteristics

|                                 |               |
|---------------------------------|---------------|
| Board name                      | PCI-20023M    |
| Manufacturer                    | Burr-Brown    |
| Bus type                        | ISA           |
| Access method                   | Memory mapped |
| Multiple block instance support | No            |
| Multiple board support          | Yes           |

### PCI-20023M Analog Input (A/D)

Scaling Input to Output.

| Hardware Input | Block Output Data Type | Scaling |
|----------------|------------------------|---------|
| volts          | Double                 | 1       |

#### Driver Block Parameters.

**Number of Channels** — Enter a number between 1 and 8 to select the number of A/D channels used. This driver does not the selection of individual channels.

Number the channels beginning with 1 even if the board manufacturer starts numbering the channels with 0.

**Input Range** — Enter an input range code for all A/D channels. This driver does not allow the selection of a different range for individual channel. The input range is the same for all A/D channels.

The following table is a list of the ranges for this driver and the corresponding range codes.

| Input range (V) | Range code | Input range (V) | Range code |
|-----------------|------------|-----------------|------------|
| -10 to +10      | -10        | 0 - 10          | 10         |
| -5 to +5        | -5         |                 |            |

The jumpers W1, W2, W4, W5, W33 on the module must correspond to this range setting. The switch and jumper settings, that are not mentioned here, have no influence on running xPC Target.

**Sample time** — Enter the base sample time or a multiple of the base sample time.

**Module Number (1-3)** — Enter a number from 1 to 3 to identify the connector on the carrier board where the I/O module is inserted. This driver verifies if the module is placed on the specified module connector.

**Base Address of Carrier Board (ie. 0xd000)** — Enter the base address of the I/O board. It is important that this entry corresponds to the DIP-switch settings on the board. For example, if the base address is 300 (hexadecimal), enter

0x300

Other jumpers on this board. The switch and jumper settings, that are not mentioned here, have no influence on the running of xPC Target.

| Jumper Number | Jumper | Jumper Number | Jumper |
|---------------|--------|---------------|--------|
| W6            | out    | W12           | out    |
| W8            | in     | W27           | out    |
| W9            | -      | W30           | -      |
| W10           | out    | W31           | -      |
| W11           | in     |               |        |

## PCI-20041C

The PCI-20041C is a carrier board with 32 digital I/O-lines grouped into four ports that can be configured as digital input or output. Each port has a maximum of 8 digital lines.

xPC Target supports this board with these driver blocks:

- “PCI-20041C Digital Input” on page 35-9
- “PCI-20041C Digital Output” on page 35-10

### Board Characteristics

|                                 |               |
|---------------------------------|---------------|
| Board name                      | PCI-20041C    |
| Manufacturer                    | Burr-Brown    |
| Bus type                        | ISA           |
| Access method                   | Memory mapped |
| Multiple block instance support | Yes           |
| Multiple board support          | Yes           |

### PCI-20041C Digital Input

Use a separate driver block for each port. By selecting the digital input driver block, the port is configured as input.

#### Scaling Input to Output.

| Hardware Input | Block Output Data Type | Scaling                         |
|----------------|------------------------|---------------------------------|
| TTL            | Double                 | TTL low = 0.0<br>TTL high = 1.0 |

#### Driver Block Parameters.

**Number of Channels** — Enter a number between 1 and 8 to select the number of digital input lines used with this port.

**Port Number (1-4)** — Enter a number from 1 to 4 to identify the port used with this block of digital input lines.

**Sample time** — Enter a base sample time or a multiple of the base sample time.

**Module Number (0-3)** — Enter a number from 0 to 3 to identify the connector on the carrier board where the I/O module is inserted. This driver verifies if the module is placed on the specified module connector.

**Base Address or Carrier Board (ie: 0xd000)** — Enter the base address of the board. This entry must correspond to the DIP-switch settings on the board. For example, if the base address is 300 (hexadecimal), enter

0x300

**PCI-20041C Digital Output**

Use a separate driver block for each port. By selecting the digital output driver block, the port is configured as output.

**Scaling Input to Output.**

| Hardware Output | Block Input Data Type | Scaling                             |
|-----------------|-----------------------|-------------------------------------|
| TTL             | Double                | < 0.5 = TTL low<br>≥ 0.5 = TTL high |

**Driver Block Parameters.**

**Number of Channels** — Enter a number between 1 and 8 to select the number of digital output lines used with this port.

**Port Number (0-3)** — Enter a number from 0 to 3 to identify the port used with this block of digital output lines.

**Sample Time** — Enter a base sample time or a multiple of the base sample time.

**Module Number (1-3)** — Enter a number from 1 to 3 to identify the connector on the carrier board where the I/O module is inserted. This driver verifies if the module is placed on the specified module connector.

**Base Address or Carrier Board (ie: 0xd000)** — Enter the base address of the board. This entry must correspond to the DIP-switch settings on the board. For example, if the base address is d000 (hexadecimal), enter

0xd000

## PCI-20098C

The PCI-20098C is a carrier board with 8 single or 16 differential analog input (A/D) channels (12-bit), and 16 digital I/O-lines grouped into two 8-line ports.

xPC Target supports this board with these driver blocks:

- “PCI-20098C Analog Input (A/D)” on page 35-11
- “PCI-20098C Digital Input” on page 35-12
- “PCI-20098C Digital Output” on page 35-13

### Board Characteristics

|                                 |                           |
|---------------------------------|---------------------------|
| Board Name                      | PCI-20098C                |
| Manufacturer                    | Burr-Brown                |
| Bus Type                        | ISA                       |
| Access Method                   | Memory mapped             |
| Multiple block instance support | A/D: No, Digital I/O: Yes |
| Multiple board support          | Yes                       |

### PCI-20098C Analog Input (A/D)

Scaling Input to Output.

| Hardware Input | Block Output Data Type | Scaling |
|----------------|------------------------|---------|
| volts          | Double                 | 1       |

**Driver Block Parameters.**

**Number of Channels** — If you select 16 channels (**Input coupling** parameter set to 16 single-ended channels) enter a number between 1 and 16 to select the number of single A/D channels used. If you select eight channels (**Input coupling** parameter set to 8 differential channels) enter a number between 1 and 8. This driver does not allow the selection of individual channels or a different **Input coupling** setting for each channel.

**Range** — From the list, choose either +- 10V (-10 to +10 volts), +-5V (-5 to +5 volts), or 0-10V. This driver does not allow the selection of a different range for each channel. The input range is the same for all A/D channels

**Input coupling** — From the list, select one from the following list of input modes:

- 16 single-ended channels
- 8 differential channels

This entry must correspond to the MUX-switch setting on the board.

**Sample time** — Enter the base sample time or a multiple of the base sample time.

**Base Address or Carrier Board (ie: 0xd000)** — Enter the base address of the board. This entry must correspond to the DIP-switch settings on the board. For example, if the base address is 300 (hexadecimal), enter

0x300

**PCI-20098C Digital Input**

Use a separate driver block for each port. By selecting the digital input driver block, the port is configured as input.

**Scaling Input to Output.**

| Hardware Input | Block Output Data Type | Scaling                         |
|----------------|------------------------|---------------------------------|
| TTL            | Double                 | TTL low = 0.0<br>TTL high = 1.0 |



**Driver Block Parameters.**

**Number of Channels** — Enter a number between 1 and 8 to select the number of digital input lines used with this port.

**Port Number** — From the list, choose either A or B to identify the port used with this block of I/O lines.

**Sample Time** — Enter a base sample time or a multiple of the base sample time.

**Base Address or Carrier Board (ie: 0xd000)** — Enter the base address of the board. This entry must correspond to the DIP-switch settings on the board. For example, if the base address is 300 (hexadecimal), enter

0x300

**PCI-20098C Digital Output**

Use a separate driver block for each port. By selecting the digital output driver block, the port is configured as output.

**Scaling Input to Output.**

| Hardware Output | Block Input Data Type | Scaling                             |
|-----------------|-----------------------|-------------------------------------|
| TTL             | Double                | < 0.5 = TTL low<br>≥ 0.5 = TTL high |

**Driver Block Parameters.**

**Number of Channels** — Enter a number between 1 and 8 to select the number of digital output lines used with this port.

Number lines beginning with 1 even if the board manufacturer starts numbering lines with 0.

**Port Number** — From the list, choose either **A** or **B** to identify the port used with this block of I/O lines.

**Sample time** — Enter a base sample time or a multiple of the base sample time.

**Base Address or Carrier Board (ie: 0xd000)** — Enter the base address of the board. This entry must corresponds to the DIP-switch settings on the board. For example, if the base address is 300 (hexadecimal), enter

0x300

## Gespac

I/O boards supported by xPC Target (<http://www.gespac.com>).

### GESADA-1

The GESADA-1 is an industrial I/O board with 16 single or 8 differential analog input (A/D) channels, and 4 analog output (D/A) channels (10-bit).

xPC Target supports this board with these driver blocks:

- “GESADA-1 Analog Input (A/D)” on page 35-16
- “GESADA-1 Analog Output (D/A)” on page 35-17

---

**Note** xPC Target does not support the external trigger and interrupt propagation on this board.

---

### Board Characteristics

|                                 |                |
|---------------------------------|----------------|
| Board name                      | GESADA-1       |
| Manufacturer                    | Gespac         |
| Bus type                        | ISA industrial |
| Access method                   | I/O mapped     |
| Multiple block instance support | No             |
| Multiple board support          | Yes            |

## GESADA-1 Analog Input (A/D)

### Scaling Input to Output.

| Hardware Input | Block Output Data Type | Scaling |
|----------------|------------------------|---------|
| volts          | Double                 | 1       |

### Driver Block Parameters.

**Number of channels** — If you select 16 channels (**Input coupling** parameter set to 16 single-ended channels) enter a number between 1 and 16. If you select eight channels (**Input coupling** parameter set to 8 differential channels) enter a number between 1 and 8.

Number the lines beginning with 1 even if the board manufacturer starts numbering the lines with 0.

**Range vector** — From the list, choose either +-10V (-10 to +10 volts), +-5V (-5 to +5 volts), or 0-10V. This driver does not allow you to select a different range for each channel. The input range is the same for all A/D channels.

The input range setting must correspond to the settings of jumper J6 and J9 on the board.

**Input coupling** — From the list, select one from the following list of input modes:

- Single-ended channels (16 channels)
- Differential channels (8 channels)

This choice must correspond to the MUX-switch setting on the board.

The differential mode is only supported if the board is equipped with option 1A. The MUX setting must correspond to the settings of jumper J3 and J7 on the board.

**Sample time** — Base sample time or a multiple of the base sample time.

**Base address** — Enter the base address of the board. It is important that this entry corresponds to the DIP-switch settings on the board. For example, if the base address is 300 (hexadecimal), enter

0x300

## GESADA-1 Analog Output (D/A)

### Scaling Input to Output.

| Hardware Output | Block Input Data Type | Scaling |
|-----------------|-----------------------|---------|
| volts           | Double                | 1       |

### Driver Block Parameters.

**Channel vector** — This parameter is a combined Channel vector and Range vector. The number of elements defines the number of D/A channels used.

Enter a range code for each of the channels used. This driver allows a different range for each D/A channel with a maximum of 2 channels.

The following table is a list of the ranges for this driver and the corresponding range codes.

| Input Range (V) | Range Code | Input Range (V) | Range Code |
|-----------------|------------|-----------------|------------|
| -10 to +10      | -10        | 0 - 10          | 10         |
| -5 to +5        | -5         |                 |            |

For example, if the first channel is -10 to + 10 volts and the second, third and fourth channel are -5 to +5 volts, enter

```
[ -10,5,5,5]
```

The range settings have to correspond to the jumper setting of J5 on the board.

**Sample time** — Enter the base sample time or a multiple of the base sample time.

**Base address** — Enter the base address of the board. This entry must correspond to the DIP-switch settings on the board. For example, if the base address is 300 (hexadecimal), enter

```
0x300
```

The base address specifies the base address of the board and has to correspond to the Jumper setting (J12) on the board.

## GESPIA-2A

The GESPIA-2A is an industrial I/O board with 32 digital I/O lines. The GESPIA-2A has two 6821 PIAs (0 and 1) from Motorola. Each PIA has two ports (A and B) with 8 digital lints which can be defined as input or output.

xPC Target supports this board with these driver blocks:

- “GESPIA-2A Digital Input” on page 35-18
- “GESPIA-2A Digital Output” on page 35-19

### Board Characteristics

|                                 |                |
|---------------------------------|----------------|
| Board name                      | GESPIA-2A      |
| Manufacturer                    | Gespac         |
| Bus type                        | ISA industrial |
| Access method                   | I/O mapped     |
| Multiple block instance support | Yes            |
| Multiple board support          | Yes            |

### GESPIA-2A Digital Input

Use a separate driver block for each port. By selecting the digital input driver block, the port is configured as input.

#### Scaling Input to Output.

| Hardware Input | Block Output Data Type | Scaling                         |
|----------------|------------------------|---------------------------------|
| TTL            | Double                 | TTL low = 0.0<br>TTL high = 1.0 |

#### Driver Block Parameters.

**Number of channels** — Enter a number between 1 and 8 to select the number of digital input lines used with this port.

**Port Name** — From the list, choose either PIA0A, PIA0B, PIA1A or PIA1B to identify the port used with this block of I/O lines.

**Sample time** — Enter a base sample time or a multiple of the base sample time.

**Base address** — Enter the base address of the board. This entry must corresponds to the DIP-switch settings on the board. For example, if the base address is 300 (hexadecimal), enter

0x300

### GESPIA-2A Digital Output

Use a separate driver block for each port. By selecting the digital output driver block, the port is configured as output.

**Scaling Input to Output.**

| Hardware Output | Block Input Data Type | Scaling                             |
|-----------------|-----------------------|-------------------------------------|
| TTL             | Double                | < 0.5 = TTL low<br>≥ 0.5 = TTL high |

**Driver Block Parameters.**

**Number of channels** — Enter a number between 1 and 8 to select the number of digital output lines used with this port.

**Port Name** — From the list, choose either PIA0A, PIA0B, PIA1A or PIA1B to identify the port used with this block of I/O lines.

**Sample time** — Enter a base sample time or a multiple of the base sample time.

**Base address** — Enter the base address of the board. This entry must corresponds to the DIP-switch settings on the board. For example, if the base address is 300 (hexadecimal), enter

0x300

## Measurement Computing (Computer Boards)

I/O boards supported by xPC Target  
(<http://www.measurementcomputing.com>).

There are new versions of the following Measurement Computing Incremental Encoder drivers. Please use the new version of these drivers. This topic describes the obsoleted drivers:

- “CIO-QUAD02 Incremental Encoder (Obsolete)” on page 35-20
- “CIO-QUAD04 Incremental Encoder (Obsolete)” on page 35-22
- “PCI-QUAD04 Incremental Encoder (Obsolete)” on page 35-24

To access the previous versions of these drivers, use the `xpcobsoletelib` command. The presence of the obsoleted versions of these drivers is not guaranteed for future releases.

### CIO-QUAD02 Incremental Encoder (Obsolete)

This driver block has three block outputs: **Angle**, **Turns**, and **Init**.

You can use **Init** to determine when the block output values are valid. **Init** is first set to 0. When the encoder reached the first index, **Init** is set to 1. From then on, you can determine the exact position, direction, and velocity. **Init** remains 1 unless **Counter Reset by Index** is set to **First Only**, and the counter detects a rollover. For more information, see “Driver Block Parameters” on page 35-21.

**Turns** is the number of complete revolutions made by the encoder. **Angle** is the amount the encoder turns since the last full revolution.

The distance is given by:

$$\text{distance} = 2 * \pi * \text{Turns} + \text{Angle}$$

The velocity is given by:

$$\text{velocity} = (\text{distance}(t_s) - \text{distance}(t_s-1)) / t_s$$

The direction is given by:

$$\text{direction} = \text{distance}(t_s) - \text{distance}(t_s-1)$$

A negative value is reverse, while a positive value is forward.



## Driver Block Parameters

**Function module** — From the list choose 1 or 2. This parameter specifies which channel you use for this block. For the same board (same base address) two blocks cannot have the same channel number.

**Counter Reset by Index** — From the list choose either Only First, or Continuous.

If you choose Only First, the first time the encoder reaches the index, the counter is reset to zero, the **Init** output signal is set to 1, and the encoder begins to count. The encoder ignores all other times it reaches the index. **Init** remains 1 until a rollover is detected, and then set to -1. A rollover is when the counter reaches its maximum value and begins to start counting at zero again. A rollover can also occur when the counter reaches its minimum value and the counter resets itself to the maximum value and resumes counting down. The outputs are still accurate after rollover. The -1 flag is used to alert that a rollover has occurred.

If you choose Continuous, the first time the encoder reaches the index, the counter is reset to zero, the **Init** output signal is set to 1, and the encoder begins to count. Each time the encoder reaches the index, it resets to zero. **Init** remains always at 1 because a rollover cannot occur.

**Positive Rotation** — From the list, choose either Clockwise or Counter Clockwise. This parameter sets the direction for positive rotation. If you choose Clockwise, when the encoder is turned clockwise it counts up, and when turned counter clockwise it counts down. If you choose Counter Clockwise the counting direction is reversed.

**Mode** — From the list, choose Single, Double, or Quadruple. This parameter specifies the phase detection mode. That is, how many phase changes are detected. For more information, see the board manual.

**Resolution** — This field specifies the divisions of the connected incremental encoder for one revolution.

**Filter prescale factor** — Enter a base prescale factor for digital filtering. This filter helps eliminate high frequency noise. Enter a value from 0 to ff in hexadecimal (0 to 256 in decimal). For example, for a prescale factor value of ff in hexadecimal, enter

0xff

**Sample Time** — Enter a base sample time or a multiple of the base sample time. The sample time indicates the update rate of registration on the input (Duty Cycle). Enter -1 to inherit the model sample time from another block. The sample time is in seconds.

**Base Address** — Enter the base address of the board. It is important that this entry corresponds to the DIP-switch settings on the board. For example, if the base address is 300 (hexadecimal), enter

0x300

## **CIO-QUAD04 Incremental Encoder (Obsolete)**

This driver block has three block outputs: **Angle**, **Turns**, and **Init**.

You can use **Init** to determine when the block output values are valid. **Init** is first set to 0. When the encoder reached the first index, **Init** is set to 1. From then on, you can determine the exact position, direction, and velocity. **Init** remains 1 unless **Counter Reset by Index** is set to **First Only**, and the counter detects a rollover. For more information, see “Driver Block Parameters” on page 35-21.

**Turns** is the number of complete revolutions made by the encoder. **Angle** is the amount the encoder turns since the last full revolution.

The distance is given by:

$$\text{distance} = 2 * \text{pi} * \text{Turns} + \text{Angle}$$

The velocity is given by:

$$\text{velocity} = (\text{distance}(t_s) - \text{distance}(t_s-1)) / t_s$$

The direction is given by:

$$\text{direction} = \text{distance}(t_s) - \text{distance}(t_s-1)$$

A negative value is reverse, while a positive value is forward.

## Driver Block Parameters

**Function module** — From the list choose, **1**, **2**, **3**, or **4**. This parameter specifies which channel you use for this block. For the same board (same base address) two blocks cannot have the same channel number.

**Counter Reset by Index** — From the list choose either **Only First**, or **Continuous**.

If you choose **Only First**, the first time the encoder reaches the index, the counter is reset to zero, the **Init** output signal is set to 1, and the encoder begins to count. The encoder ignores all other times it reaches the index. **Init** remains 1 until a rollover is detected, and then set to -1. A rollover is when the counter reaches its maximum value and begins to start counting at zero again. A rollover can also occur when the counter reaches its minimum value and the counter resets itself to the maximum value and resumes counting down. The outputs are still accurate after rollover. The -1 flag is used to alert that a rollover has occurred.

If you choose **Continuous**, The first time the encoder reaches the index, the counter is reset to zero, the **Init** output signal is set to 1, and the encoder begins to count. Each time the encoder reaches the index, it resets to zero. **Init** remains always at 1 because a rollover cannot occur.

**Positive Rotation** — From the list, choose either **Clockwise** or **Counter Clockwise**. This parameter sets the direction for positive rotation. If you choose **Clockwise**, when the encoder is turned clockwise it counts up, and when turned counter clockwise it counts down. If you choose **Counter Clockwise** the counting direction is reversed.

**Mode** — From the list, choose **Single**, **Double**, or **Quadruple**. This parameter specifies the phase detection mode. That is, how many phase changes are detected. For more information, see the board manual.

**Resolution** — This field specifies the divisions of the connected incremental encoder for one revolution.

**Filter prescale factor** — Enter a base prescale factor for digital filtering. This filter helps eliminate high frequency noise. Enter a value from 0 to ff in hexadecimal (0 to 256 in decimal). For example, for a prescale factor value of ff in hexadecimal, enter

0xff

**Sample time** — Enter a base sample time or a multiple of the base sample time. The sample time indicates the update rate of registration on the input (Duty Cycle). Enter -1 to inherit the model sample time from another block. The sample time is in seconds.

**Base address** — Enter the base address of the board. It is important that this entry corresponds to the DIP-switch settings on the board. For example, if the base address is 300 (hexadecimal), enter

0x300

### PCI-QUAD04 Incremental Encoder (Obsolete)

This driver block has three block outputs: **Angle**, **Turns**, and **Init**.

You can use **Init** to determine when the block output values are valid. **Init** is first set to 0. When the encoder reached the first index, **Init** is set to 1. From then on, you can determine the exact position, direction, and velocity. **Init** remains 1 unless **Counting reset by index** is set to Only First, and the counter detects a rollover. For more information, see “Driver Block Parameters” on page 35-21.

**Turns** is the number of complete revolutions made by the encoder. **Angle** is the amount the encoder turns since the last full revolution.

The distance is given by:

$$\text{distance} = 2 * \text{pi} * \text{Turns} + \text{Angle}$$

The velocity is given by:

$$\text{velocity} = (\text{distance}(t_s) - \text{distance}(t_s-1)) / t_s$$

The direction is given by:

$$\text{direction} = \text{distance}(t_s) - \text{distance}(t_s-1)$$

A negative value is reverse, while a positive value is forward.

## Driver Block Parameters

**Function module** — From the list choose 1, 2, 3, or 4. This parameter specifies which channel you use for this block. For the same board (same base address) two blocks cannot have the same channel number.

**Counting reset by index** — From the list choose Only First, Continuous, or Index input disabled.

If you choose Only First, the first time the encoder reaches the index, the counter is reset to zero, the **Init** output signal is set to 1, and the encoder begins to count. The encoder ignores all other times it reaches the index. **Init** remains 1 until a rollover is detected, and then set to -1. A rollover is when the counter reaches its maximum value and begins to start counting at zero again. A rollover can also occur when the counter reaches its minimum value and the counter resets itself to the maximum value and resumes counting down. The outputs are still accurate after rollover. The -1 flag is used to alert that a rollover has occurred.

If you choose Continuous, The first time the encoder reaches the index, the counter is reset to zero, the **Init** output signal is set to 1, and the encoder begins to count. Each time the encoder reaches the index, it resets to zero. **Init** remains always at 1 because a rollover cannot occur.

**Positive Rotation** — From the list, choose either Clockwise or Counter Clockwise. This parameter sets the direction for positive rotation. If you choose Clockwise, when the encoder is turned clockwise it counts up, and when turned counter clockwise it counts down. If you choose Counter Clockwise, the counting direction is reversed.

**Mode** — From the list, choose Single, Double, or Quadruple. This parameter specifies the phase detection mode. That is, how many phase changes are detected. For more information, see the board manual.

**Resolution** — This field specifies the divisions of the connected incremental encoder for one revolution.

**Filter prescale factor** — Enter a base prescale factor for digital filtering. This filter helps eliminate high frequency noise. Enter a value from 0 to ff in hexadecimal (0 to 256 in decimal). For example, for a prescale factor value of ff in hexadecimal, enter

0xff

**Sample time** — Enter a base sample time or a multiple of the base sample time. The sample time indicates the update rate of registration on the input (Duty Cycle). Enter -1 to inherit the model sample time from another block. The sample time is in seconds.

**PCI Slot (-1:autosearch)** — If only one board of this type is physically present in the target PC, enter

-1

to automatically locate the board.